



OWNER'S MANUAL

25-Channel Lighted Big Button Cordless Phone



SP-514

Cat. No. 43-5514

WARNING: To reduce the risk of fire or shock hazard, do not expose this product to rain or moisture.



CAUTION

RISK OF ELECTRIC SHOCK.
DO NOT OPEN.



CAUTION: TO REDUCE THE RISK OF ELECTRIC SHOCK, DO NOT REMOVE COVER OR BACK. NO USER-SERVICEABLE PARTS INSIDE. REFER SERVICING TO QUALIFIED PERSONNEL.



This symbol is intended to alert you to the presence of uninsulated dangerous voltage within the product's enclosure that might be of sufficient magnitude to constitute a risk of electric shock. Do not open the product's case.



This symbol is intended to inform you that important operating and maintenance instructions are included in the literature accompanying this product.

Important: Cordless phones such as this one require AC power to operate. When the AC power is off, you cannot dial out or receive incoming calls using your SP-514. For this reason, the SP-514 cordless phone should not be your only telephone. To be safe, you should also have a phone that does not require AC power to operate (not a cordless phone) so you can still make and receive calls if there is an AC power failure.

Your SP-514 operates on standard radio frequencies, as allocated by the FCC. Therefore, it is possible for other radio units operating on similar frequencies, within a certain area, to inadvertently intercept your conversations and/or cause interference on your cordless telephone. This lack of privacy can occur with any cordless telephone.

RadioShack is a registered trademark used by Tandy Corporation.
The Sprint Logo is a registered trademark of Sprint Communications Company L.P. Used under license.



n Features

Your RadioShack SP-514 25-Channel Lighted Big Button Cordless Phone offers the latest advances in cordless phone technology with large lighted keys for easy-to-see dialing. Its cordless operation lets you handle calls just about anywhere in your home or office.

The SP-514 has these features:

25 Channels — automatically selects a clear channel when you make or answer a call. You can also manually change channels during a call.

Volume Control — lets you adjust the volume you hear through the handset.

Handset Locator/Paging System — lets you send a signal from the base to the handset to page someone or locate the handset when it is away from the base.

10-Number Memory Dialing — lets you store 10 numbers in memory for easy dialing.

21-Day Battery — the supplied battery (when fully charged) provides about 21 days of standby time.

Redial — lets you quickly redial the last number dialed.

Flash — sends an electronic switchhook signal for use with special phone services such as Call Waiting.

Security Access-Protection Code — changes each time you unplug the phone from AC power, to help prevent other cordless phone users from using your phone line while the handset is off the base.

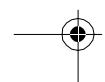
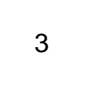
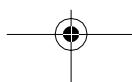
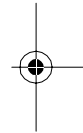
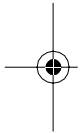



This telephone has been tested and found to comply with all applicable UL and FCC standards.

We recommend you record your phone's serial number here. The number is on the bottom of the base.

Serial Number: _____

READ THIS BEFORE INSTALLATION

Each device that you connect to the phone line draws power from the phone line. We refer to this power draw as the device's *ringer equivalence number*, or REN. The REN is on the bottom of the base.

If you are using more than one phone or other device on the line, add up all the RENs. If the total is more than five, your phone might not ring. In rural areas, a total REN of three might impair ringer operation. If ringer operation is impaired, remove a device from the line.

FCC STATEMENT

This telephone complies with Part 68 of *FCC Rules*. You must, upon request, provide the FCC registration number and the REN to your phone company. These numbers are on the bottom of the base.

Note: You must not connect your SP-514 to any of the following:

- 2 coin-operated systems
- 2 party-line systems
- 2 most electronic key phone systems

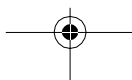

n CONTENTS

Installation	6
Selecting a Location	6
Placing the Base on a Desk Top	7
Mounting the Base on a Wall	8
Installing and Charging the Battery Pack	9
Preparation	11
Setting the Dialing Mode	11
Setting the Handset's Ringer	12
Telephone Operation	12
Making and Receiving a Call	12
Setting the Handset's Volume	13
Changing the Channel	14
Using Redial	14
Using Flash	15
Using Mute	15
Using Tone Services on a Pulse Line	16
Using Page/Handset Locator	16
Memory Dialing	17
Storing a Number in Memory	17
Entering a Pause	18
Dialing a Memory Number	19
Chain-Dialing Service Numbers	19
Testing Stored Emergency Numbers	19
Troubleshooting	20
Care and Maintenance	23
Replacing the Handset Battery Pack	24
The FCC Wants You to Know	25
Lightning	26
Notes	27

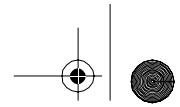

Installation



n Installation

SELECTING A LOCATION

You can place the phone on a desk top or table, mount it on a standard wall plate, or mount it directly on the wall. Select a location that is:

- ² near an AC outlet not controlled by a wall switch
- ² near a telephone line jack
- ² out of the way of normal activities
- ² away from electrical machinery, electrical appliances, metal walls or filing cabinets, wireless intercoms, alarms, and room monitors

The base's location affects the phone's range. If you have a choice of several locations, try each to see which provides the best performance.



Caution: You must use a Class 2 power source that supplies 12 volts DC and delivers at least 200 mA. Its center tip must be set to positive and its plug must fit the SP-514's **POWER** jack. The supplied adapter meets these specifications. Using an adapter that does not meet these specifications could damage the SP-514 or the adapter.

Notes:

- ² Your telephone connects directly to a modular telephone line jack. If your phone line jack is not a modular jack, you can update the wiring yourself, using jacks and adapters available at your local RadioShack store. Or, you can let the phone company update the wiring for you.
- ² The USOC number of the jack to be installed is RJ11C (RJ11W for a wall plate).

PLACING THE BASE ON A DESK TOP

Follow these steps when you place the base on a desk, shelf, or table.

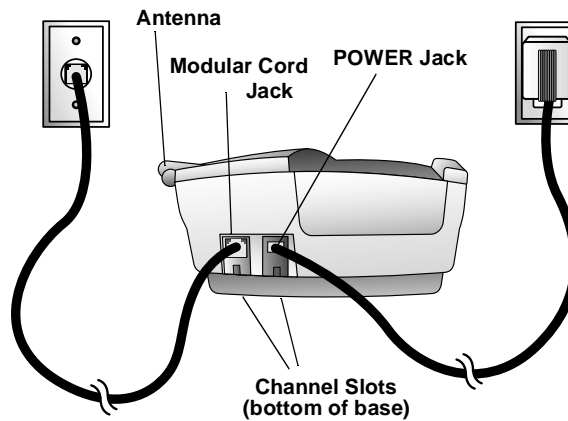

- 1 Plug one end of the supplied long modular cord into the modular cord jack on the back of the base.
- 2 Route the modular cord through the channel slot on the bottom of the base.
- 3 Insert the supplied AC adapter's barrel plug into the **POWER** jack on the back of the base.
- 4 Route the adapter's cord through the other channel slot on the bottom of the base.
- 5 Plug the modular cord's other end into a modular phone line jack.
- 6 Plug the adapter into a standard AC outlet.
- 7 Fully extend the base's antenna and raise it to a vertical position.

Installation

MOUNTING THE BASE ON A WALL

Note: To mount the base directly on the wall, you need two screws (not supplied) with heads that fit into the keyhole slots on the bottom of the base. Drill two holes $3^{15}/16$ inches (100 mm) apart, one above the other. Then thread a screw into each hole, letting the heads extend about $5/16$ inch (7 mm) from the wall.

1 Plug one end of the supplied modular cord into the modular cord jack and the supplied AC adapter's barrel plug into the **POWER** jack on the back of the base.

2 Route the adapter cord and modular cord through the channel slots on the bracket's narrow end. Wrap the excess modular cord in the groove in the bottom of the base. Route the end of the adapter cord through the channel slot at the bottom of the base.

3 Plug the modular cord's loose end into the wall plate jack (or a modular phone line jack), align the base's keyhole slots with the wall plate studs (or the screws in the wall), and slide the base downward to secure it.

4 Plug the adapter into a standard AC outlet. Fully extend the base's antenna and raise it to a vertical position

Modular Cord Jack POWER Jack

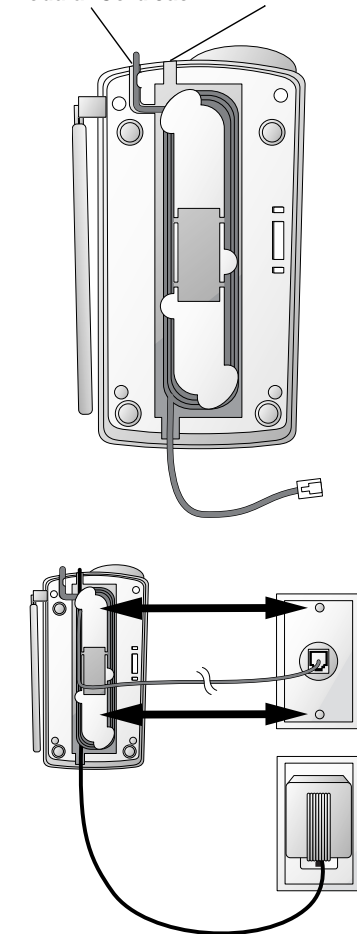

Installation

INSTALLING AND CHARGING THE BATTERY PACK

The SP-514 is packaged with a rechargeable nickel-cadmium battery pack. Before using your phone, you must install the battery pack and then charge it for 10 hours.

Press down and slide off the compartment cover. Plug the battery connector into the socket inside the compartment. Then place the battery pack into the compartment and replace the cover.

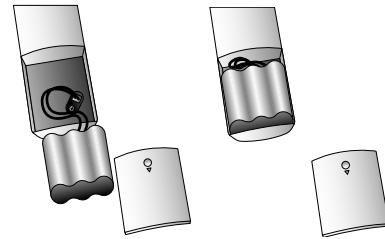

Note: The connector fits only one way. Do not force it.

To charge the battery pack, simply place the handset facedown on the base. The CHARGING indicator on the base lights.



Recharge the battery pack when the LOW BATT indicator on the handset flashes.

**LOW BATT
Indicator**

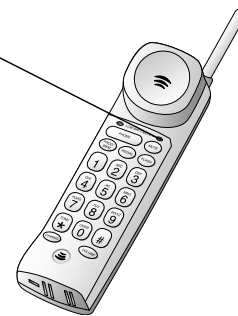



Installation



Notes:

² When you first use the phone after charging or recharging the battery pack, the phone might not work and you might hear a two-beep signal when you press **PHONE**. If this happens, return the handset to the base for about 30 seconds. This resets the security access protection code.

² If the CHARGING indicator does not light when you place the handset on the base, be sure the battery pack and AC adapter are correctly and securely connected.

Also, check the charging contacts on the handset and the base. If the contacts are dirty or tarnished, clean them with a pencil eraser.

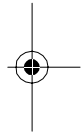
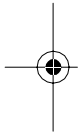
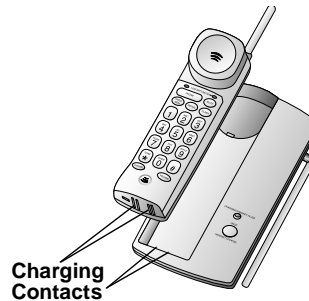

² If the battery pack gets completely discharged or the base loses power while the handset is away from it, the security access-protection code needs to be reset. To reset the code, place the handset on the base for about 30 seconds. If it was the handset that lost power, leave the handset on the base to charge the battery pack.

² If the battery pack gets weak during a call, the handset sounds 4 beeps every 30 seconds. If this happens, you cannot make another call on the phone until you recharge the battery pack.

² About once a month, fully discharge the battery pack by keeping the handset off the base until the LOW BATT indicator lights. Otherwise, the battery pack loses its ability to fully recharge.

² If you are not going to use your phone for an extended period of time, disconnect the battery pack. This increases the battery pack's usable life.

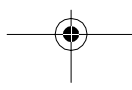

Preparation

- The supplied battery pack should last for about a year. When it loses its ability to fully recharge, order a replacement battery pack from your local RadioShack store (see "Replacing the Handset Battery Pack" on Page 24).

n Preparation

SETTING THE DIALING MODE

Set the dialing mode for the type of service you have. If you are not sure which type you have, once the battery pack is fully charged, do this test.

- Lift the handset, then press **PHONE** and listen for the dial tone.

- Press any number other than **0**.

Note: If your phone system requires that you dial an access code (9, for example) before you dial an outside number, do not press the access code either.

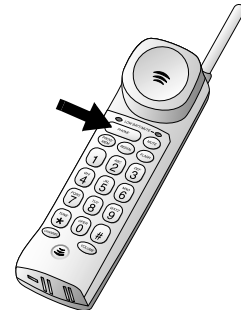

If the dial tone stops, you have touch-tone service. Since the phone is preset to touch-tone service, you do not have to make any change to the dialing mode.

If the dial tone continues, you have pulse service. Press **PHONE # # # 3**.

If your phone is set for pulse service and you want to change the dialing mode to touch-tone service, press **PHONE # # # 8**.



Telephone Operation



SETTING THE HANDSET'S RINGER

You can turn off the handset's ringer by setting **RINGER** on the side of the handset to **OFF**. Turn it back on by setting **RINGER** to **ON**.

n Telephone Operation

MAKING AND RECEIVING A CALL

To make a call, lift the handset and press **PHONE**. The keypad number, **TONE** (✖), and # buttons light. When the **PHONE** indicator lights steadily and you hear the dial tone, dial a phone number or memory number (see "Memory Dialing" on Page 17).

PHONE
Indicator



To answer a call if the handset is on the base, simply lift the handset and begin your conversation. Or, if the handset is away from the base, press **PHONE** first. The **PHONE** indicator on the handset and the **HANDSET IN USE** indicator on the base light.

HANDSET
IN USE
Indicator

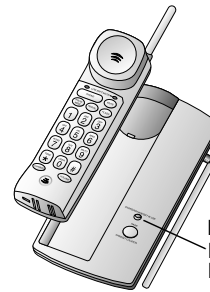

Note: If **RINGER** is set to **OFF**, you must press **PHONE** on the handset to answer a call.

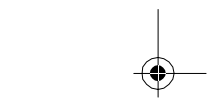
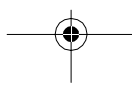



Telephone Operation

To end a call, place the handset on the base or press **PHONE**. The indicators turn off.

Notes:

- ² If you press **PHONE** to hang up and the phone does not disconnect, move closer to the base then press **PHONE** again, or place the handset on the base.
- ² If you want to make a call but the handset is out of the base's range, the handset beeps twice. Move the handset closer to the base and try again.

SETTING THE HANDSET'S VOLUME

You can select any of three volume levels by repeatedly pressing **VOLUME** during a call.

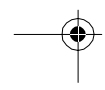
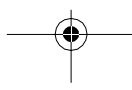
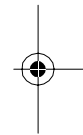
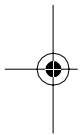

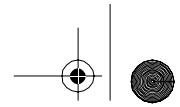

Telephone Operation



CHANGING THE CHANNEL

The SP-514 scans 25 channels (frequency pairs used between the base and the handset) and automatically selects a clear channel each time you make or receive a call.

If you hear other conversations or excessive noise during a call, press **CHANNEL** on the handset to select a different channel.

Note: If the handset is too far from the base, the channel might not change. Move closer to the base and try again.

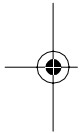

USING REDIAL

You can quickly redial the last number dialed. Simply lift the handset and press **PHONE**. When you hear the dial tone, press **REDIAL**.

Notes:

² The redial memory holds up to 16 digits, so you can redial long-distance as well as local numbers.

² We recommend you not use **REDIAL** to dial numbers that include a tone entry. This could result in a wrong number being dialed. (See "Using Tone Services on a Pulse Line" on Page 16.)

² The redial memory only stores digits entered after you press **FLASH** (see "Using Flash" on Page 15).

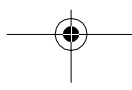
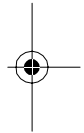

Telephone Operation

USING FLASH

FLASH performs the electronic equivalent of a switchhook operation for special services, such as Call Waiting.

For example, if you have Call Waiting, press **FLASH** to answer an incoming call without disconnecting the current call. Press **FLASH** again to return to the first call.

Note: If you do not have any special phone services, pressing **FLASH** might disconnect the current call.



USING MUTE

To talk to someone else in the room without the person on the other end of the phone line hearing your conversation, press **MUTE** during the call. The MUTE indicator on the handset lights.

To resume your phone conversation, press **MUTE** again.



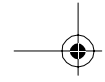

Telephone Operation



USING TONE SERVICES ON A PULSE LINE

Some special services, such as bank-by-phone, require tone signals. If you have pulse service, you can still use these special tone services by following these steps.

- 1 Dial the service's main number.
- 2 When the service answers, press **TONE** (*). Any additional numbers you dial are sent as tone signals.
- 3 After you complete the call, return the handset on the base or press **PHONE**. The phone automatically resets to pulse dialing.

USING PAGE/HANDSET LOCATOR

You can use the SP-514 as a pager and handset locator between the base and the handset. This is useful if the handset is away from the base and you want to locate it, or if you want to signal the person holding the handset.

To page the person who has the handset or to locate the handset when the phone is not in use, press **PAGE/HANDSET LOCATOR** on the base. The keypad lights and the handset sounds a three-beep signal. If you want the handset to beep for a longer time, hold down **PAGE/HANDSET LOCATOR** for about 4 seconds. The handset beeps for about 3 minutes.

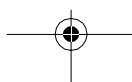
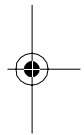
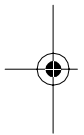
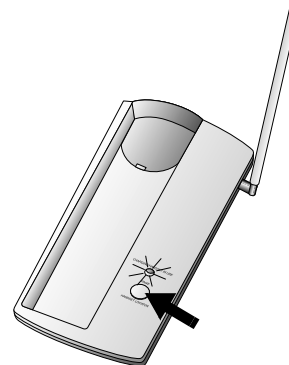



Telephone Operation



To stop the handset from beeping before it automatically stops, press **CHANNEL** on the handset or **PAGE/HANDSET LOCATOR** on the base.

Note: You cannot page the handset during a call.

MEMORY DIALING

You can store up to 10 numbers (up to 16 digits each) in memory, then dial a stored number by pressing **PROG/MEM** and one of the number buttons.

Storing a Number in Memory

Notes:

- 2 If the dialing mode is set for pulse service and you want to use tone dialing for a memory number, you must store a tone as the first entry of the number (see "Using Tone Services on a Pulse Line" on Page 16).
- 2 Do not store a number with both pulse and tone entries in the same memory location. This could result in a wrong number being dialed.
- 2 Each pause (see "Entering a Pause" on Page 18) and tone entry uses one digit of memory.
- 2 To keep your accounts secure, we recommend you do not store your personal access code for services such as bank-by-phone in a memory location.
- 2 An error tone sounds and the phone exits the programming mode if you wait more than 30 seconds between each keypress or enter more than 16 digits. You must start over at Step 1.

Follow these steps to store a number in memory.

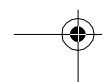
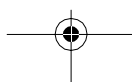
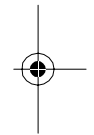
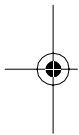

Telephone Operation

1 Press **PROG/MEM**.

2 Enter the number you want to store. (To store the last number you dialed, simply press **REDIAL**.)

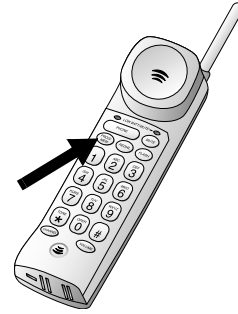

If you enter a wrong digit, press **PHONE** twice to exit the procedure. Then start over at Step 1.

3 Press **PROG/MEM** then press one of the number buttons (**0-9**). The SP-514 beeps three times.

Note: If you receive a call while you are storing information in memory, press **PHONE** to answer the call. A tone sounds. After the call, begin again at Step 1.

A memory index sticker is supplied with your SP-514. We recommend you write each stored number next to its number key location (MEM 1 for number 1, MEM 2 for 2, and so on). (Use a pencil in case you change the stored number.) Peel the backing from the sticker and attach it to the handset or the base.

To replace a stored number, simply store a new one in its place.

Entering a Pause

In some telephone systems, you must dial an access code (9, for example) and wait for a second dial tone before you can dial an outside number. You can store the access code with the phone number. However, you should also store a pause after the access code to allow the outside line time to connect. To do so, hold down the number immediately preceding the pause until you hear a second beep. (For example, if 9 is your access code, hold down 9 until you hear a second beep.) This enters a 1.5-second pause.



Telephone Operation



For a longer pause, hold down the number key until you hear additional beeps.

Dialing a Memory Number

Press **PHONE**. When you hear the dial tone, press **PROG/MEM**, then press the number button for the number you are calling.

Chain-Dialing Service Numbers

For quick recall of numbers for special services (such as alternate long distance or bank by phone), store each group of numbers in its own memory location.

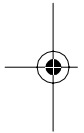

When calling special services, dial the service's main number first. Then at the appropriate place in the call, press **PROG/MEM**, then enter the number for the location where the additional information is stored.

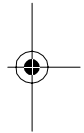

Testing Stored Emergency Numbers

If you store an emergency service's number (police department, fire department, ambulance) and you choose to test the stored number, make the test call during the late evening or early morning hours to avoid peak demand periods. Remain on the line to explain the reason for your call.

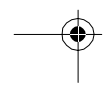
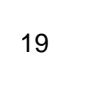
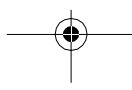



Troubleshooting



n Troubleshooting

We do not expect you to have any problems with your SP-514, but if you do, the following suggestions might help.

Problem	Suggestion
The handset does not work.	Move the handset closer to the base.
	Be sure the phone line cord and AC adapter are correctly and securely connected.
	Be sure the battery pack is connected and charged.
	Fully extend and raise the base's antenna to a vertical position.
	Return the handset to the base for 15 seconds, then try again.
	<p data-bbox="771 1012 1261 1073"><i>If these suggestions do not solve the problem, try resetting the security code:</i></p> <p data-bbox="771 1083 1266 1325">2 Place the handset on the base and make sure the CHARGING light is on. Unplug the AC adapter from the outlet. Wait 15 seconds, then plug the AC adapter in again. Pick up the handset and press PHONE. The phone should operate properly. If it does not, try the next step.</p> <p data-bbox="771 1335 1266 1570">2 Remove the handset battery pack. Wait 30 seconds, then reinstall it. Place the handset on the base and make sure the CHARGING light is on. Wait 30 seconds. then pick up the handset and press PHONE. The phone should operate properly.</p>
Volume drops or you hear unusual sounds.	Someone has picked up another phone on the same line. Hang up the other phone.

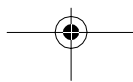

Troubleshooting

Problem	Suggestion
Call is noisy.	Do not place the base near appliances or large metal objects.
	Fully extend and raise the base's antenna to a vertical position.
	Move the handset closer to the base.
	Keep the handset away from interference sources such as computers, remote control toys, wireless alarm systems, wireless intercoms and room monitors, fluorescent lights, and electrical appliances. If the interference is severe, turn off the interfering device.
	Press CHANNEL to switch to another channel.
	Hang up and redial the number.
The phone does not ring.	Be sure the handset's ringer is set to ON .
	Be sure the phone line cord and AC adapter are correctly and securely connected.
	Move the handset closer to the base.
	There might be too many devices connected to the phone line. Remove a device from the line.
The handset's range decreases.	Fully extend and raise the base's antenna to a vertical position.
	Return the handset to the base to recharge the battery pack.
	Be sure the base's antenna is not touching a metal surface.
Receiver sound flutters or fades.	Be sure the battery pack is charged.
	Fully extend and raise the base's antenna to a vertical position.
	Move the handset closer to the base.

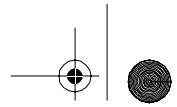

Troubleshooting



Problem	Suggestion
Can receive calls, but cannot make calls.	Set the dialing mode correctly for the type of service you have (see "Setting the Dialing Mode" on Page 11).

If you still have problems, disconnect the phone. If other phones on the same line work properly, the fault is in this phone or its installation. If you cannot find the problem, take your SP-514 to your local RadioShack store for assistance.

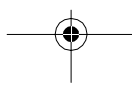
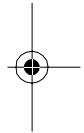
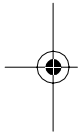

Phone Care and Maintenance

Your SP-514 25-Channel Lighted Big Button Phone is an example of superior design and craftsmanship. The following suggestions will help you care for your phone so you can enjoy it for years.



Keep the phone dry. If it gets wet, wipe it dry immediately. Liquids can contain minerals that corrode the electronic circuits.



Handle the phone gently and carefully. Dropping it can damage circuit boards and cases and cause the phone to work improperly.



Use and store the phone only in normal temperature environments. Temperature extremes can shorten the life of electronic devices, damage batteries, and distort or melt plastic parts.



Keep the phone away from dust and dirt which can cause premature wear of parts.



Wipe the phone with a damp cloth occasionally to keep it looking new. Do not use harsh chemicals, cleaning solvents, or strong detergents to clean your phone.

Modifying or tampering with the phone's internal components can cause a malfunction and might invalidate its warranty and void your FCC authorization to operate it. If your phone is not performing as it should, take it to your local RadioShack store for assistance. If the trouble is affecting the phone lines, the phone company might ask you to disconnect your phone until you have resolved the problem.



Care and Maintenance



REPLACING THE HANDSET BATTERY PACK

If you follow the instructions in “Installing and Charging the Battery Pack” on Page 9, the battery pack should last about one year. If the battery pack does not hold a charge for more than 2 hours after an overnight charge, replace the battery pack with a new 3.6 volt, 270 milliamp battery pack. You can order a replacement battery pack through your local RadioShack store.

Follow the directions in “Installing and Charging the Battery Pack” on Page 9 to install and charge the new battery pack.

Cautions:

- ² You must use a replacement battery pack of the same size and type.
- ² Dispose of the battery pack promptly and properly. Do not bury or burn it.
- ² Always remove old or weak batteries. Batteries can leak chemicals that can destroy electronic parts.

If you have trouble replacing the battery pack, take the phone to your local RadioShack store for assistance.

Important: This product contains a rechargeable nickel-cadmium battery pack. At the end of the battery pack’s useful life, it must be recycled or disposed of properly. Contact your local, county, or state hazardous waste management authorities for information on recycling or disposal programs in your area. Some options that might be available are: municipal curb-side collection, drop-off boxes at retailers such as your local RadioShack store, recycling collection centers, and mail-back programs.

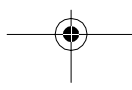
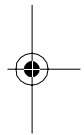
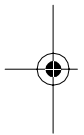



Care and Maintenance



THE FCC WANTS YOU TO KNOW

In the unlikely event that your phone causes problems on the phone line, the phone company can temporarily discontinue your service. If this happens, the phone company attempts to notify you in advance. If advance notice is not practical, the phone company notifies you as soon as possible and advises you of your right to file a complaint with the FCC.

Also, the phone company can make changes to its lines, equipment, operations, or procedures that could affect the operation of this telephone. The telephone company notifies you of these changes in advance, so you can take the necessary steps to prevent interruption of your telephone service.

Your phone might cause TV or radio interference even when it is operating properly. To determine whether your phone is causing the interference, turn off your phone. If the interference goes away, your phone is causing the interference. Try to eliminate the interference by:

- 2 moving your phone away from the receiver
- 2 connecting your phone to an AC outlet that is on a different electrical circuit from the receiver
- 2 contacting your local RadioShack store for help

If you cannot eliminate the interference, the FCC requires that you stop using your phone.

Some cordless telephones operate on frequencies that may cause interference to nearby TVs and VCRs. To minimize or prevent such interference, the base of the cordless telephone should not be placed near or on top of a TV or VCR.

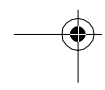
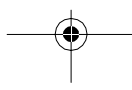
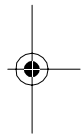
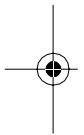

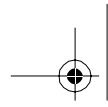

Care and Maintenance

LIGHTNING

Your telephone has built-in lightning protection to reduce the risk of damage from surges in telephone line and power line current. This lightning protection meets or exceeds FCC requirements. However, lightning striking the telephone or power lines can damage your telephone.

Lightning damage is not common. Nevertheless, if you live in an area that has severe electrical storms, we suggest that you unplug your phone during storms to reduce the possibility of damage.

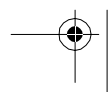
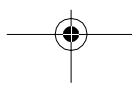
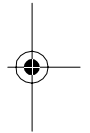
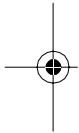

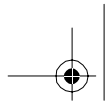

Notes



n Notes

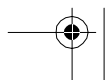
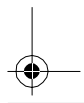
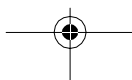
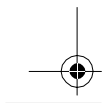
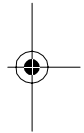
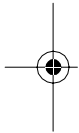



Limited One-Year Warranty

This product is warranted by RadioShack against manufacturing defects in material and workmanship under normal use for one (1) year from the date of purchase from RadioShack company-owned stores and authorized RadioShack franchisees and dealers. EXCEPT AS PROVIDED HEREIN, RadioShack MAKES NO EXPRESS WARRANTIES AND ANY IMPLIED WARRANTIES, INCLUDING THOSE OF MERCHANTABILITY AND FITNESS FOR A PARTICULAR PURPOSE, ARE LIMITED IN DURATION TO THE DURATION OF THE WRITTEN LIMITED WARRANTIES CONTAINED HEREIN. EXCEPT AS PROVIDED HEREIN, RadioShack SHALL HAVE NO LIABILITY OR RESPONSIBILITY TO CUSTOMER OR ANY OTHER PERSON OR ENTITY WITH RESPECT TO ANY LIABILITY, LOSS OR DAMAGE CAUSED DIRECTLY OR INDIRECTLY BY USE OR PERFORMANCE OF THE PRODUCT OR ARISING OUT OF ANY BREACH OF THIS WARRANTY, INCLUDING, BUT NOT LIMITED TO, ANY DAMAGES RESULTING FROM INCONVENIENCE, LOSS OF TIME, DATA, PROPERTY, REVENUE, OR PROFIT OR ANY INDIRECT, SPECIAL, INCIDENTAL, OR CONSEQUENTIAL DAMAGES, EVEN IF RadioShack HAS BEEN ADVISED OF THE POSSIBILITY OF SUCH DAMAGES.

Some states do not allow the limitations on how long an implied warranty lasts or the exclusion of incidental or consequential damages, so the above limitations or exclusions may not apply to you.

In the event of a product defect during the warranty period, take the product and the RadioShack sales receipt as proof of purchase date to any RadioShack store. RadioShack will, at its option, unless otherwise provided by law: (a) correct the defect by product repair without charge for parts and labor; (b) replace the product with one of the same or similar design; or (c) refund the purchase price. All replaced parts and products, and products on which a refund is made, become the property of RadioShack. New or reconditioned parts and products may be used in the performance of warranty service. Repaired or replaced parts and products are warranted for the remainder of the original warranty period. You will be charged for repair or replacement of the product made after the expiration of the warranty period.

This warranty does not cover: (a) damage or failure caused by or attributable to acts of God, abuse, accident, misuse, improper or abnormal usage, failure to follow instructions, improper installation or maintenance, alteration, lightning or other incidence of excess voltage or current; (b) any repairs other than those provided by a RadioShack Authorized Service Facility; (c) consumables such as fuses or batteries; (d) cosmetic damage; (e) transportation, shipping or insurance costs; or (f) costs of product removal, installation, set-up service adjustment or reinstallation.

This warranty gives you specific legal rights, and you may also have other rights which vary from state to state.

RadioShack Customer Relations, Dept. W, 100 Throckmorton St., Suite 600, Fort Worth, TX 76102

We Service What We Sell

3/97

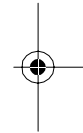
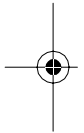

RadioShack
A Division of Tandy Corporation
Fort Worth, Texas 76102

09/98

Printed in Mexico

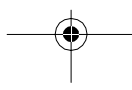

Free Manuals Download Website

<http://myh66.com>

<http://usermanuals.us>

<http://www.somanuals.com>

<http://www.4manuals.cc>

<http://www.manual-lib.com>

<http://www.404manual.com>

<http://www.luxmanual.com>

<http://aubethermostatmanual.com>

Golf course search by state

<http://golfingnear.com>

Email search by domain

<http://emailbydomain.com>

Auto manuals search

<http://auto.somanuals.com>

TV manuals search

<http://tv.somanuals.com>