



MATRIX GX3000S

25 Watt VHF/FM

ITU Class D DSC Marine Transceiver

Owner's Manual

- Waterproof construction
- Commercial grade ITU Class D DSC VHF
- Independent Channel 70 receiver built-in for continuous DSC watching
- 30 W Loud Hailer with listen back and 4 fog horns, Bells & Whistles
- Capable of connecting 2 optional enhanced **CMP25 RAM+** second station remote microphone or **VH-310** Handset
- Intercom between radio and second station microphone
- DSC position request and send functions with compatible STANDARD HORIZON GPS Chart plotters
- Versatile user-programmable scanning, priority scan and Dual Watch
- One-button access to Channel 16 and 9
- Oversized rotary channel knob, backlit display and keys.
- Navigation information shown on display when optional GPS connected
- Unique Receive Audio Tone Control

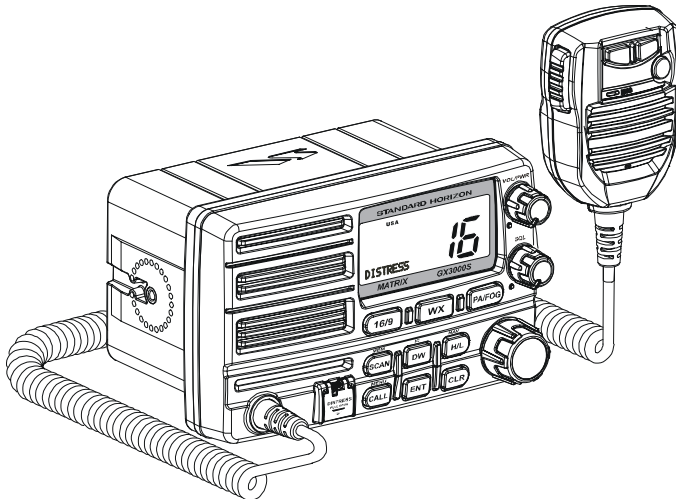

TABLE OF CONTENTS

| | | |
|-----------|--|-----------|
| 1 | GENERAL INFORMATION | 4 |
| 2 | PACKING LIST | 4 |
| 3 | OPTIONS | 4 |
| 4 | SAFETY / WARNING INFORMATION | 5 |
| 5 | FCC RADIO LICENSE INFORMATION | 6 |
| 6 | FCC NOTICE | 7 |
| 7 | GETTING STARTED | 8 |
| | 7.1 ABOUT VHF RADIO | 8 |
| | 7.2 SELECTING AN ANTENNA | 8 |
| | 7.3 COAXIAL CABLE | 9 |
| 8 | INSTALLATION | 10 |
| | 8.1 LOCATION | 10 |
| | 8.2 ELECTRICAL CONNECTIONS | 10 |
| | 8.3 ACCESSORY CABLE | 11 |
| | 8.4 CHECKING GPS CONNECTIONS | 12 |
| | 8.5 CHANGING THE GPS TIME | 12 |
| | 8.6 CHANGING THE TIME LOCATION | 13 |
| | 8.7 CHANGING COG TO TRUE OR MAGNETIC | 13 |
| | 8.8 RECEIVER AUDIO TONE CONTROL | 14 |
| | 8.9 OPTIONAL MMB-84 FLUSH MOUNT INSTALLATION | 15 |
| | 8.10 OPTIONAL ENHANCED RAM+ SECOND STATION MIC AND/OR VH-310 HANDSET INSTALLATION | 16 |
| 9 | CONTROLS AND INDICATORS | 18 |
| 10 | BASIC OPERATION | 24 |
| | 10.1 RECEPTION | 24 |
| | 10.2 TRANSMISSION | 24 |
| | 10.3 TRANSMIT TIME-OUT TIMER (TOT) | 24 |
| | 10.4 SIMPLEX / DUPLEX CHANNEL USE | 25 |
| | 10.5 USA, CANADA, AND INTERNATIONAL MODE | 25 |
| | 10.6 NOAA WEATHER CHANNELS | 25 |
| | 10.6.1 NOAA Weather Alert | 25 |
| | 10.6.2 NOAA Weather Alert Testing | 26 |
| | 10.7 EMERGENCY (CHANNEL 16 USE) | 26 |
| | 10.8 CALLING ANOTHER VESSEL (CHANNEL 16 OR 9) | 27 |
| | 10.9 MAKING TELEPHONE CALLS | 27 |
| | 10.10 OPERATING ON CHANNELS 13 AND 67 | 28 |
| | 10.11 DUAL WATCH (TO PRIORITY CHANNEL) | 28 |
| | 10.12 SCANNING | 29 |
| | 10.12.1 Selecting the Scan Mode | 29 |
| | 10.12.2 Memory Scanning (M-SCAN) | 29 |
| | 10.12.3 Priority Scanning (P-SCAN) | 30 |
| | 10.13 FOG / PA OPERATION | 31 |
| | 10.13.1 Operating the PA HAIL mode | 31 |
| | 10.13.2 Operating the FOG HORN mode | 31 |
| | 10.14 NAVIGATION INDICATION | 32 |
| | 10.15 INTERCOM OPERATION | 32 |
| | 10.15.1 Communication | 33 |
| | 10.15.2 Calling | 33 |
| | 10.16 VOICE SCRAMBLER | 34 |
| 11 | DIGITAL SELECTIVE CALLING | 35 |
| | 11.1 GENERAL | 35 |
| | 11.2 MARITIME MOBILE SERVICE IDENTITY (MMSI) | 36 |
| | 11.2.1 What is an MMSI? | 36 |
| | 11.2.2 Programming the MMSI | 36 |
| | 11.3 DSC DISTRESS CALL | 37 |
| | 11.3.1 Transmitting a DSC Distress Call | 37 |
| | 11.3.2 Receiving a DSC Distress Call | 39 |
| | 11.4 ALL SHIPS CALL | 39 |
| | 11.4.1 Transmitting an All Ships Call | 40 |
| | 11.4.2 Receiving an All Ships Call | 40 |
| | 11.5 INDIVIDUAL CALL | 41 |
| | 11.5.1 Setting up the Individual / Position Call Directory | 41 |
| | 11.5.2 Setting up Individual Ringer | 42 |
| | 11.5.3 Setting up Individual / Group Call Ringer | 43 |
| | 11.5.4 Transmitting an Individual Call | 44 |
| | 11.5.5 Receiving an Individual Call | 46 |



TABLE OF CONTENTS

| | | |
|-----------|---|-----------|
| 11.6 | CALL WAITING DIRECTORY | 46 |
| 11.6.1 | Enabling the Call Waiting Feature | 46 |
| 11.6.2 | Reviewing Received Calls Logged into the Call Waiting Directory | 47 |
| 11.6.3 | To Delete the Received Log From the "DSC Log" Directory | 47 |
| 11.7 | GROUP CALL | 48 |
| 11.7.1 | Setting up a Group Call | 48 |
| 11.7.2 | Transmitting a Group Call | 49 |
| 11.7.3 | Receiving a Group Call | 51 |
| 11.8 | POSITION REQUEST | 52 |
| 11.8.1 | Setting up Position Reply | 52 |
| 11.8.2 | Transmitting a Position Request to Another Vessel | 53 |
| 11.8.3 | Receiving a Position Request | 55 |
| 11.9 | POSITION SEND | 56 |
| 11.9.1 | Setting up Position Send Ringer | 56 |
| 11.9.2 | Transmitting a DSC Position Send Call | 56 |
| 11.9.3 | Receiving a DSC Position Send Call | 57 |
| 11.10 | MANUAL INPUTTING GPS LOCATION (LAT/LON) | 58 |
| 12 | RADIO SETUP MODE | 59 |
| 12.1 | LAMP ADJUSTING | 59 |
| 12.2 | LCD CONTRAST | 59 |
| 12.3 | TIME OFFSET | 60 |
| 12.4 | TIME LOCATION | 61 |
| 12.5 | TRUE MAGNETIC CHANGE (NAV display) | 61 |
| 12.6 | PRIORITY CHANNEL SET | 62 |
| 12.7 | SCAN TYPE | 62 |
| 12.8 | SCAN RESUME TIME | 63 |
| 12.9 | KEY BEEP (ON/OFF) | 63 |
| 12.10 | WX ALERT | 64 |
| 12.11 | VOICE SCRAMBLER | 64 |
| 12.12 | CHANNEL NAME CHANGE | 65 |
| 12.13 | NAMING THE RADIO OR SECOND STATION MIC OR HANDEST | 66 |
| 12.14 | FOG ALERT TONE FREQUENCY | 67 |
| 12.15 | RECEIVER AUDIO TONE CONTROL | 67 |
| 13 | ENHANCED RAM+ MIC OPERATION | 68 |
| 13.1 | RAM+ MIC CONTROLS | 68 |
| 13.2 | FOG / PA OPERATION | 70 |
| 13.2.1 | Operating the PA / HAIL mode | 70 |
| 13.2.2 | Operating the FOG HORN mode | 71 |
| 13.3 | INTERCOM OPERATION | 71 |
| 13.3.1 | Communication | 71 |
| 13.3.2 | Calling | 71 |
| 13.4 | DSC / RADIO SETUP MODE | 72 |
| 14 | VH-310 HANDSET OPERATION | 74 |
| 14.1 | VH-310 HANDSET CONTROLS | 74 |
| 14.2 | FOG / PA OPERATION | 78 |
| 14.2.1 | Operating the PA HAIL mode | 78 |
| 14.2.2 | Operating the FOG HORN mode | 78 |
| 14.3 | INTERCOM OPERATION | 79 |
| 14.3.1 | Communication | 79 |
| 14.3.2 | Calling | 79 |
| 14.4 | MANUAL INPUTTING OF THE GPS LOCATION (LAT/LON) | 80 |
| 14.5 | DSC / RADIO SETUP MODE | 81 |
| 14.5.1 | Changing GPS Information to Vessel position or COG | 82 |
| 14.5.2 | External Speaker AF Selection | 82 |
| 15 | MAINTENANCE | 84 |
| 15.1 | REPLACEMENT PARTS | 84 |
| 15.2 | FACTORY SERVICE | 85 |
| 15.3 | TROUBLESHOOTING CHART | 86 |
| 16 | CHANNEL ASSIGNMENTS | 88 |
| 17 | WARRANTY | 94 |
| 18 | SPECIFICATIONS | 97 |
| 19 | APPENDIX | 98 |



1 GENERAL INFORMATION

The Vertex Standard **GX3000S** is a VHF/FM transceiver designed for use in the frequency range of 156.025 to 163.275 MHz. The **GX3000S** can be operated from 11 to 16 VDC and has a switchable RF output power of 1 watt or 25 watts.

The **GX3000S** is a Class D DSC (Digital Selective Calling) VHF and includes a 30W PA with preprogrammed fog signals, bells and whistles. 2 connections are available for the RAM+ or **VH-310** second station remote microphones. Class D operation allows continuous receiving of Digital Selective Calling functions on channel 70 even if the radio is receiving a call.

2 PACKING LIST

When the package containing the transceiver is first opened, please check it for the following contents:

- **GX3000S** Transceiver
- Mounting Bracket and mounting hardware
- Dust Cover
- Owner's Manual
- Power Cord

3 OPTIONS

| | |
|-----------------------|--|
| MMB-84 | Flush-Mount Bracket |
| CMP25B/W | Remote-Access Microphone (RAM+ Mic, Black/White) |
| VH-310 | Remote Handset (available in Black) |
| CVS2500 | Voice Scrambler |
| CT-100 | 23-foot Extension Cable for RAM+ Mic |
| MLS-310 | Amplified External Speaker |
| MLS-300 | External Loudspeaker |
| 101W | White External Speaker |
| 220SW | 4.5" Round Hail/PA Horn |
| 240SW | 5" x 8" Rectangular Hail/PA Horn |

4 SAFETY / WARNING INFORMATION

This radio is restricted to occupational use, work related operations only where the radio operator must have the knowledge to control the exposure conditions of its passengers and bystanders by maintaining the minimum separation distance of 0.6 m (2 feet).

Failure to observe these restrictions will result in exceeding the FCC RF exposure limits.

Antenna Installation:

The antenna must be located at least 0.6 m (2 feet) away from passengers in order to comply with the FCC RF exposure requirements.

ON-LINE WARRANTY REGISTRATION

Please visit www.standardhorizon.com to register the **GX3000S** Marine VHF. It should be noted that visiting the Web site from time to time may be beneficial to you, as new products are released they will appear on the Marine Division of Vertex Standard Web site.

PRODUCT SUPPORT INQUIRIES

If you have any questions or comments regarding the use of the **GX3000S**, you can visit the Marine Division of Vertex Standard Web site to send an E-Mail or contact the Product Support team at 800-767-2450 M-F 7:00-5:00PST.



5 FCC RADIO LICENSE INFORMATION

Vertex Standard radios comply with the Federal Communication Commission (FCC) requirements that regulate the Maritime Radio Service.

STATION LICENSE

An FCC ship station license is no longer required for any vessel traveling in U.S. waters (except Hawaii) which is under 20 meters in length. However, any vessel required to carry a marine radio on an international voyage, carrying a HF single side band radiotelephone or marine satellite terminal is required to have a ship station license. FCC license forms, including applications for ship (506) and land station licenses can be downloaded via the Internet at www.fcc.gov/forms. To obtain a form from the FCC, call (888) 225-5322.

RADIO CALL SIGN

Currently the FCC does not require recreational boaters to have a Ship Radio Station License. The USCG recommends the boats registration number and the state to be used.

CANADIAN SHIP STATION LICENSING

You may need a license when traveling in Canada. If you do need a license contact their nearest field office or regional office or write:

Industry Canada
Radio Regulatory Branch
Attn: DOSP
300 Slater Street
Ottawa, Ontario
Canada, KIA 0C8

FCC / INDUSTRY CANADA INFORMATION

The following data pertaining to the transceiver is necessary to fill out the license application.

Type Acceptance FCC Part 80
Output Power 1 Watt (low) and 25 Watts (high)
Emission 16K0G3E, 16K0G2B
Frequency Range 156.025 to 163.275 MHz
FCC Type Number K6630143X3D
Industry Canada Type Approval 511B-30143X3S

6 FCC NOTICE

NOTICE

Unauthorized changes or modifications to this equipment may void compliance with FCC Rules. Any change or modification must be approved in writing by Marine Division of Vertex Standard.

NOTICE

This equipment has been tested and found to comply with the limits for a Class B digital device, pursuant to Part 15 of the FCC Rules. These limits are designed to provide reasonable protection against harmful interference in a residential installation. This equipment generates, uses and can radiate radio frequency energy and, if not installed and used in accordance with the instructions, may cause harmful interference to radio communications. However, there is no guarantee that interference will not occur in a particular installation. If this equipment does cause harmful interference to radio or television reception, which can be determined by turning the equipment off and on, the user is encouraged to try to correct the interference by one or more of the following measures:

- Reorient or relocate the receiving antenna.
- Increase the separation between the equipment and receiver.
- Connect the equipment into an outlet on a circuit different from that to which the receiver is connected.
- Consult the dealer or an experienced radio/TV technician for help.



7 GETTING STARTED

7.1 ABOUT VHF RADIO

The radio frequencies used in the VHF marine band lie between 156 and 158 MHz with some shore stations available between 161 and 163 MHz. The marine VHF band provides communications over distances that are essentially "line of sight" (VHF signals do not travel well through objects such as buildings, hills or trees). Actual transmission range depends much more on antenna type, gain and height than on the power output of the transmitter. On a fixed mount 25W radio transmission expected distances can be greater than 15 miles.

7.2 SELECTING AN ANTENNA

Marine antennas are made to radiate signals equally in all horizontal directions, but not straight up. The objective of a marine antenna is to enhance the signal toward the horizon. The degree to which this is accomplished is called the antenna's gain. It is measured in decibels (dB) and is one of the major factors in choosing an antenna. In terms of effective radiated power (ERP), antennas are rated on the basis of how much gain they have over a theoretical antenna with zero gain. A 3 foot, 3dB gain antenna represents twice as much gain over the imaginary antenna.

Typically a 3 foot 3dB gain stainless steel whip is used on a sailboat mast. The longer 8 foot 6dB fiberglass whip is primarily used on power boats that require the additional gain.



7.3 COAXIAL CABLE

VHF antennas are connected to the transceiver by means of a coaxial cable, a shielded transmission line. Coaxial cable is specified by its diameter and construction.

For runs less than 20 feet, RG-58/U, about 1/4 inch in diameter is a good choice. For runs over 20 feet but less than 50 feet, the larger RG-8X should be used for cable runs over 50 feet RG213 should be used. For installation of the connector onto the coaxial cable refer to the figure below.

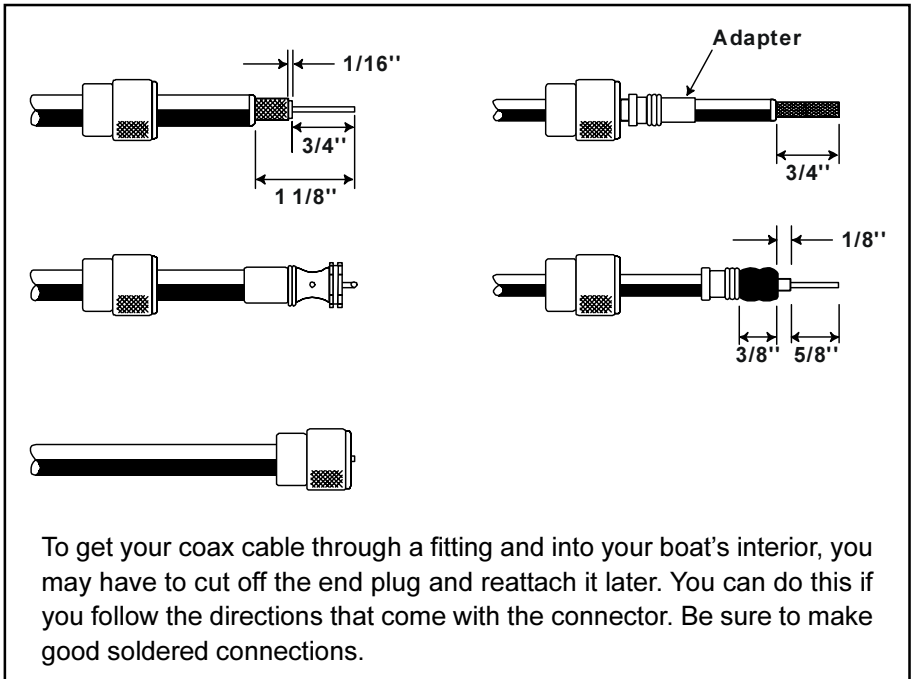

To get your coax cable through a fitting and into your boat's interior, you may have to cut off the end plug and reattach it later. You can do this if you follow the directions that come with the connector. Be sure to make good soldered connections.

8 INSTALLATION

8.1 LOCATION

The radio can be mounted at any angle. Choose a mounting location that:

- is far enough from any compass to avoid any deviation in compass reading due to the speaker magnet
- provides accessibility to the front panel controls
- allows connection to a power source and an antenna
- has nearby space for installation of a microphone hanger
- the antenna must be mounted at least 3 feet from radio

Note: To insure the radio does not affect the compass or radios performance is not affected by the antenna location, temporarily connect the radio in the desired location and:

- a. Examine the compass to see if the radio causes any deviation
- b. Connect the antenna and key the radio. Check to ensure the radio is operating correctly by requesting a radio check.

8.2 ELECTRICAL CONNECTIONS

CAUTION

Reverse polarity connections will damage the radio!

Connect the power cord and antenna to the radio. Antenna and Power Supply connections are as follows:

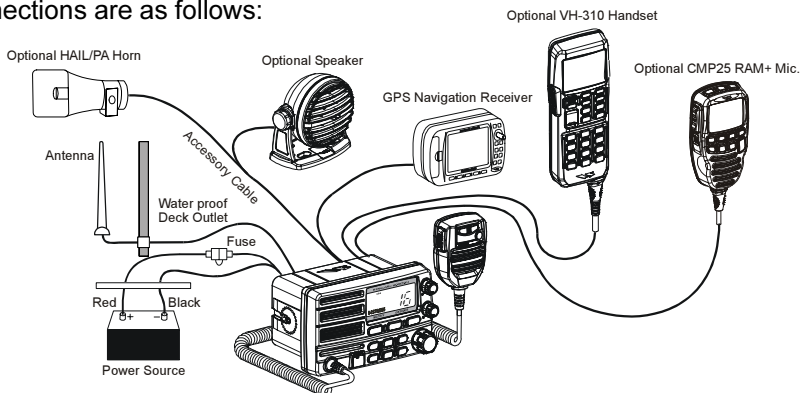

1. Mount the antenna at least 3 feet away from the radio. At the rear of the radio, connect the antenna cable.
2. Connect the red power wire to a 13.8 VDC $\pm 20\%$ power source. Connect the black power wire to a negative ground.
3. If an optional remote extension speaker is to be used, refer to next section for connections.
4. It is advisable to have a Certified Marine Technician check the power output and the standing wave ratio of the antenna after installation.

8.3 ACCESSORY CABLE

| Wire Color/Description | Connection Examples |
|-------------------------------|---|
| WHITE - External Speaker (+) | Connect to external 4 Ohm audio speaker |
| SHIELD - External Speaker (-) | Connect to external 4 Ohm audio speaker |
| RED - PA Speaker (+) | Connect to external 4 Ohm PA speaker |
| SHIELD - PA Speaker (-) | Connect to external 4 Ohm PA speaker |
| BLUE- NMEA Input (+) | Connect to NMEA (+) output of GPS |
| GREEN - NMEA Input (-) | Connect to NMEA (-) output of GPS |
| GRAY- NMEA Output (+) | Connect to NMEA (+) input of GPS |
| BROWN-NMEA Output (-) | No connection |

When connecting the external speaker or GPS navigation receiver, strip off about 1 inch (2.5 cm) of the specified wire's insulation, then splice the ends together using proper waterproofing techniques.

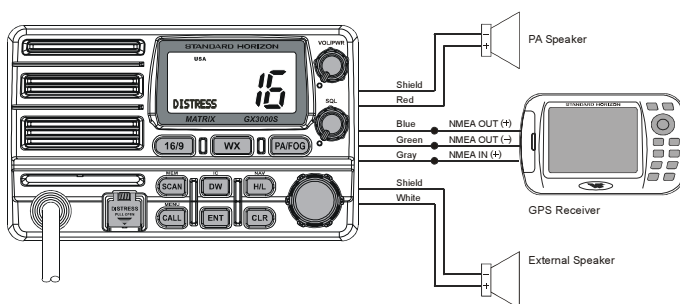

- The GPS must have the NMEA Output turned on and set to 4800 Baud in the setup menu. If there is a selection for parity select none.
- For further information on interfacing /setting up your GPS. Please contact the manufacturer of the GPS receiver.
- **GX3000S** can read NMEA-0183 version 2.0 or higher.
- The NMEA supported sentences are:
Input: GLL, GGA, RMC and GNS (RMC sentence is recommended)
Output: DSC and DSE
(DSC sentences to Standard Horizon Plotter for Position Polling)

If you have further inquires, please feel free to contact Product Support at:

Phone: (800) 767-2450

Email: marinetech@vxstdusa.com

8.4 CHECKING GPS CONNECTIONS

After connections have been made between the **GX3000S** and the GPS, a small satellite icon will appear on the top right corner of the LCD display. To see the additional GPS information, press and hold the **[H/L(NAV)]** key. The **GX3000S** shows the Date, Time, SOG and COG.

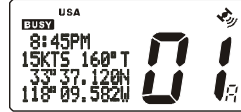

8.5 CHANGING THE GPS TIME

From the Factory the **GX3000S** shows GPS satellite time or UTC time. A time offset is needed to show the local time in your area.

1. Press and hold down the **[CALL(MENU)]** key until "Radio Setup" menu appears.
2. Press the **[ENT]** key, then select "Time Set" with the **CHANNEL** selector knob.
3. Press the **[ENT]** key.
4. Turn the **CHANNEL** selector knob to select time offset from UTC. See illustration below to find your offset time from UTC. If "0:00" is assigned, the time is the same as UTC (Universal Time Coordinated or GMT Greenwich Mean Time).
5. Press the **[ENT]** key to store the time offset.
6. Press the **[16/9]** key or turn the **CHANNEL** selector knob to select "Exit," then press the **[ENT]** key to return to the "Radio Setup" menu, select "Exit" and press the **[ENT]** key to return to radio operation.

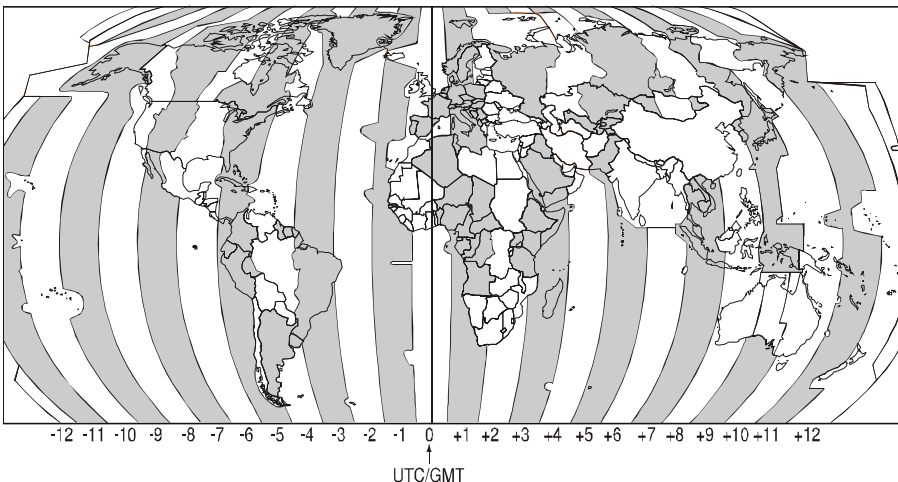
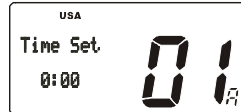

OFFSET TIME TABLE

8.6 CHANGING THE TIME LOCATION

Sets the radio to show UTC time or local time with the offset inputted in section 8.5 Changing the GPS Time.

1. Press and hold down the **[CALL(MENU)]** key until “Radio Setup” menu appears.
2. Press the **[ENT]** key, then select “Time Disp” in the “Radio Setup” menu with the **CHANNEL** selector knob.
3. Press the **[ENT]** key.
4. Turn the **CHANNEL** selector knob to select “UTC” or “Local.”
5. Press the **[ENT]** key to store the selected setting.
6. To exit this menu and return to radio operation mode press the **[16/9]** key.



In the local time mode, the display shows the time by the 12-hour system. Meanwhile, the display shows the time by the 24-hour system in the UTC mode.

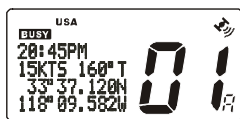

(“UTC” mode)

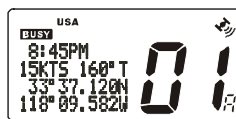

(“LOCAL” mode)

8.7 CHANGING COG TO TRUE OR MAGNETIC

Allows customizing the NAV data showing GPS Course Over Ground (COG). Factory default is True however following the steps below the COG can be changed to Magnetic.

1. Press and hold down the **[CALL(MENU)]** key until “Radio Setup” menu appears.
2. Press the **[ENT]** key, then select “Magnetic” with the **CHANNEL** selector knob.
3. Press the **[ENT]** key.
4. Turn the **CHANNEL** selector knob to select “On” (representing “Magnetic”) or “Off” (representing “True”).
5. Press the **[ENT]** key to store the selected setting.
6. Turn the **CHANNEL** selector knob to select “Exit,” then press the **[ENT]** key to return to the “Radio Setup” menu, select “Exit” and press the **[ENT]** key to return to radio operation.

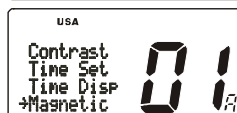

8.8 RECEIVER AUDIO TONE CONTROL

Allows the treble and bass of the speaker audio to be adjusted for best listening in noisy environments. The effect is similar to adjusting the treble and bass controls on a stereo.

1. Press and hold down the **[CALL(MENU)]** key until "Radio Setup" menu appears.
2. Press the **[ENT]** key, then select "TONE CONT." in the "Radio Setup" menu with the **CHANNEL** selector knob.
3. Press the **[ENT]** key, then select "BASS" with the **CHANNEL** selector knob.
4. Turn the **CHANNEL** selector knob to select desired audio response in the lower frequency range. Available selections are "-6" through "+6."
5. Press the **[ENT]** key to store the selected setting.
6. Select "TREBLE" with the **CHANNEL** selector knob.
7. Turn the **CHANNEL** selector knob to select desired audio response in the high frequency range. Available selections are "-6" through "+6."
8. Press the **[ENT]** key to store the selected setting.
9. To exit this menu and return to radio operation mode press the **[16/9]** key.

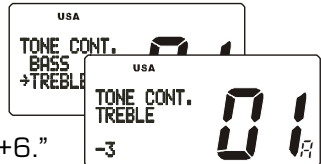
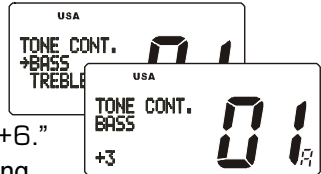
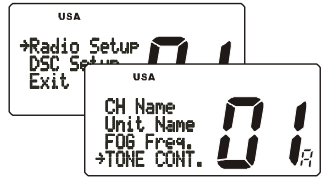

8.9 OPTIONAL MMB-84 FLUSH MOUNT INSTALLATION

1. To assist in flush mounting, a template has been included. Use this template to find the mounting location.
2. Use the template to mark the location where the rectangular hole is to be cut. Confirm the space behind the dash or panel is deep enough to accommodate the transceiver (at least 6 inches or 15 cm deep). There should be at least 1/2 inch (1.3 cm) between the transceiver's heatsink and any wiring, cables or structures.
3. Cut out the rectangular hole and insert the transceiver.
4. Fasten the brackets to the sides of the transceiver with the lock washer nut combination; so that the mounting screw base faces the mounting surface (see Figure 1).
5. Turn the adjusting screw to adjust the tension so that the transceiver is tight against the mounting surface.

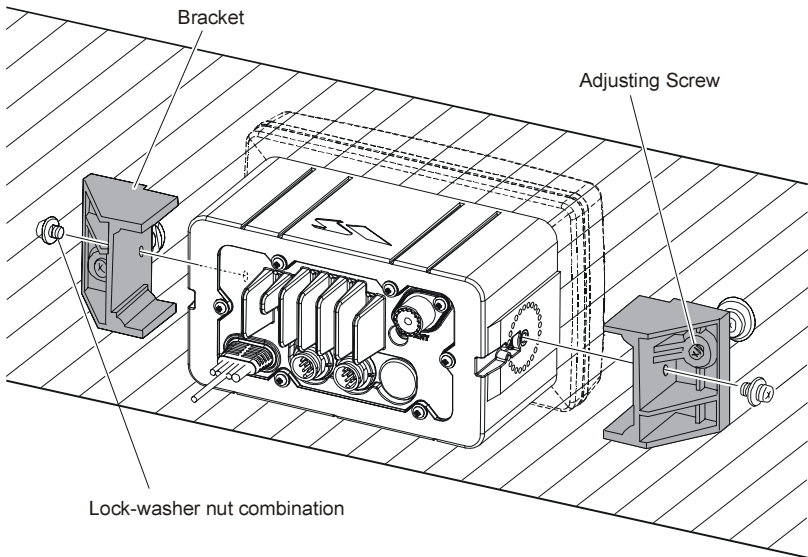

Figure 1. MMB-84 Flush Mount Installation

8.10 OPTIONAL ENHANCED RAM+ SECOND STATION MIC AND/OR VH-310 HANDSET INSTALLATION

The **GX3000S** is capable of using up to 2 Enhanced RAM+ mics or **VH-310** handsets to remotely control the Radio, DSC, and Distress functions. In addition the **GX3000S** can operate as a full function intercom system when either the RAM+ or **VH-310** is connected.

1. Connect the Routing Cable to the one of the Remote Mic eight pin connector on the rear panel, then tighten the Cable Nut (See Figure 2).
2. Referring to Figure 3, make a 1.2" (30 mm) hole in the wall, then insert the Routing Cable into this hole. Connect the Gasket and Mount Base to the Routing Cable Connector using the Nut.
3. Drill the four Screw holes (approx. 2 mm) on the wall, then install the Mounting Base to the wall using four screws.
4. Put the Rubber Cap on to the Nut. The installation is now complete.
5. Wires for a external speaker are provided on the Routing Cable. Connect any 8 Ohm external speaker. When connected the RAM+ (or **VH-310** Handset) controls the volume level of this speaker.

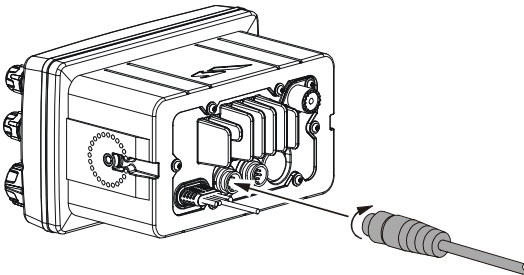

Figure 2

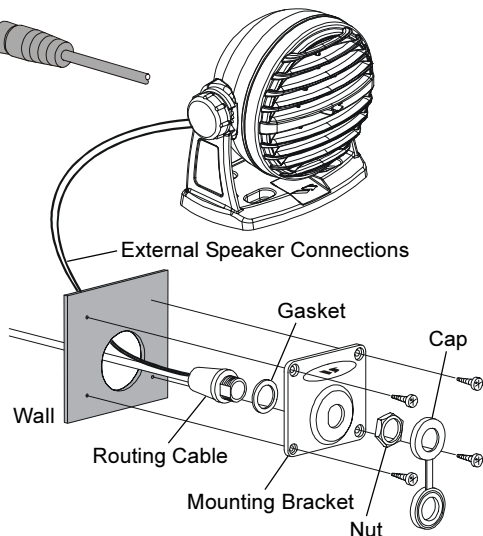

Figure 3

Remote Mic or External Speaker Selection

By default the RAM+ or **VH-310** Handset internal speaker is turned on, however using the RAM+ mic (or **VH-310** Handset) this speaker can be turned off so the external speaker can be used.

RAM+ mic procedure

1. Press and hold the [**CALL/SET**] key.
2. Press the [**▲**] or [**▼**] key to select “RADIO SETUP.”
3. Press the [**CALL/SET**] key.
4. Press the [**▼**] key to until “EXT SPK” is shown and press the [**CALL/SET**] key.
5. Press the [**▲**] or [**▼**] key to select “oF” (External speaker off) or “on” (External speaker on).
6. Press the [**CALL/SET**] key to save the selection.
7. Press the [**16/9**] key to exit this mode.

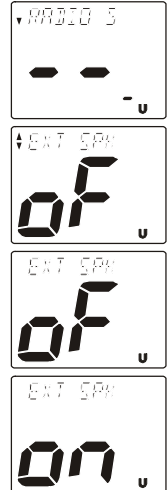

VH-310 Procedure

1. Press and hold the [**CALL(MENU)**] key.
2. Press the [**▲**] or [**▼**] key to select “RADIO SETUP.”
3. Press the [**ENT**] key
4. Press the [**▼**] key to until “EXT SPK” is shown and press the [**ENT**] key.
5. Press the [**▲**] or [**▼**] key to select “oF” (External speaker off) or “on” (External speaker on).
6. Press the [**ENT**] key to save the selection.
7. Press the [**16/9**] key to exit this mode.

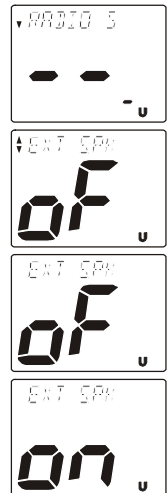

9 CONTROLS AND INDICATORS

NOTE

This section defines each control of the transceiver. See Figures for location of controls. For detailed operating instructions refer to section “10 BASIC OPERATION.”

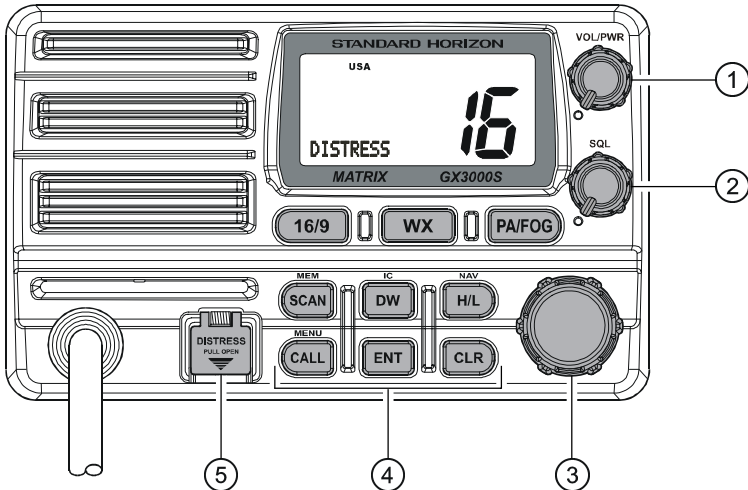

① POWER SWITCH / VOLUME CONTROL (VOL/PWR)

Turns the transceiver on and off as well as adjusts the audio volume. Press and hold this knob for one second to turn the radio on. Clockwise rotation of this knob increases the audio volume level. Press and hold this knob for two seconds to turn the radio off.

② SQUELCH CONTROL (SQL)

Adjusting this control clockwise, sets the point at which random noise on the channel does not activate the audio circuits but a received signal does. This point is called the squelch threshold. Further adjustment of the squelch control will degrade reception of wanted transmissions.

③ CHANNEL SELECTOR KNOB

The rotary knob is used to select channels and to choose menu items (such as the DSC menu, radio setup menu, and DSC setup menu). The [UP(▲)] / [DOWN(▼)] keys on the microphone can also be used to select channels and menu items.

Secondary Use

While holding down the [SCAN(MEM)] key and turning the CHANNEL selector knob, you can confirm memory channels for scanning.

④ **KEYPAD**

[16/9] Key

Immediately recalls channel 16 from any channel location. Holding down this key recalls channel 9. Pressing the **[16/9]** key again reverts to the previous selected working channel.

Secondary use

Press and hold the **[16/9]** key then press the **[WX]** key to switch the Channel Group.

[WX] Key

Immediately recalls the previously selected NOAA weather channel from any channel.

Secondary use

Holding down the **[16/9]** key while pressing the **[WX]** key changes from USA, International and Canadian channel groups.

[PA/FOG] Key

Available to operate the 30 W PA function or the FOG HORN function.

[SCAN(MEM)] Key

Press this key to start and stop the scanning of programmed channels. Refer to section “**10.12 SCANNING**” for details.

Secondary use

To memorized a channel into scan memory, select the channel and press and hold the **[SCAN(MEM)]** key until “**MEM**” is shown on the display.

To delete a memorized channel from scan memory, select the channel and press and hold the **[SCAN(MEM)]** key until “**MEM**” is removed from the display.

[DW/IC)] Key

Pressing this key enable dual watch between a priority channel (Ch16 is the default) and a selected channel until a signal is recieved. When a signal is recieved on the selected channel the radio will momentarily switch to the Priority channel and listen for communications. Refer to section “**10.11 DUAL WATCH (TO PRIORITY CHANNEL)**” for details.

Secondary use

Press and hold this key, when the optional RAM+ Mic or **VH-310** Handset is connected, intercom operation will operate between radio and option mic or handset. Refer to section “**10.15 INTERCOM OPERATION**” for details.

[H/L(NAV)] Key

Press this key to toggle the transmit output power between 25 W (High) and 1 W (Low) power. When the [H/L(NAV)] key is pressed while the transceiver is on channel 13 or 67, the power will temporarily switch from LO to HI power until the **PTT** is released.

The [H/L(NAV)] key does not function on transmit inhibited and low power only channels.

NOTE: 1W low power is indicated by LO on the display, when 25W high power is selected the display do not show an indication.

Secondary use

Press and hold this key, the LCD displays NAV GPS Data, Time, SOG (Speed Over Ground), and COG (Course Over Ground) when a GPS is connected to the accessory cable of the **GX3000S**. See section “**8.3 ACCESSORY CABLE**” for details.

[CALL(MENU)] Key

Press the [CALL(MENU)] key to access the DSC OPERATION menu. The “INDIVIDUAL CALL,” “GROUP CALL,” and “ALL SHIPS CALL” functions can be accessed from the DSC OPERATION menu.

NOTE: Before operating DSC a MMSI must be entered. Refer to section “**11.2 MARITIME MOBILE SERVICE IDENTITY (MMSI)**.”

Secondary use

Press and hold the [CALL(MENU)] key to access the “Radio Setup” (refer to section “**12 RADIO SETUP MODE**”) or “DSC Setup” menu (refer to section “**11 DIGITAL SELECTIVE CALLING**”).

[ENT] Key

Press the [ENT] Key to enter the menu selection.

[CLR] Key

Press the [CLR] Key to cancel the menu selection.

⑤ [DISTRESS] Key

Used to send a DSC Distress Call. To send the distress call refer to section “**11.3.1 (Transmitting A DSC Distress Call)**.”

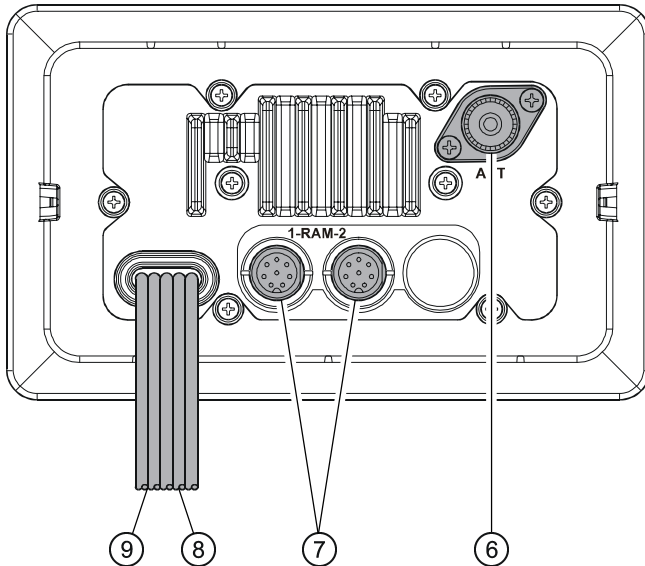

⑥ **ANTENNA JACK**

Connects an antenna to the transceiver. Use a marine VHF antenna with an impedance of 50 ohms.

⑦ **REMOTE MIC CONNECTORS**

Connects the **GX3000S** to the enhanced RAM+ MIC (Remote Access Microphone) or the **VH-310** Handset. Refer to section “**13 ENHANCED RAM+ MIC OPERATION**” or “**14 VH-310 HEADSET OPERATION**” for details.

⑧ **ACCESSORY CONNECTION CABLE**

Connects the **GX3000S** to a GPS, a PA speaker, and an external speaker.

⑨ **DC INPUT CABLE**

Connects the radio to a DC power supply capable of delivering 12V DC.

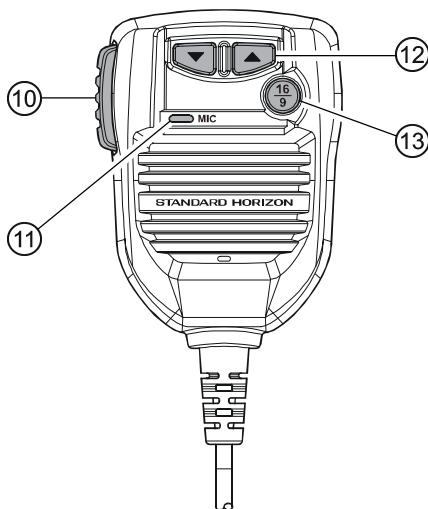

⑩ PTT (Push-To-Talk) SWITCH

Keys the transmitter when the transceiver is in radio mode. If the transceiver is in the intercom mode (between the **CMP25 RAM+** or **VH-310** Headset and the **GX3000S**), or PA mode, it activates the **GX3000S** microphone for voice communications.

⑪ MICROPHONE

Transmits the voice message with reduction of background noise, using Clear Voice Noise Reduction Technology.

NOTE: Be sure your mouth is about 1/2 inch from the mic hole for best performance.

⑫ [UP(▲)] / [DOWN(▼)] KEYS

The [UP(▲)] and [DOWN(▼)] on the microphone function the same as the **CHANNEL** selector knob on the front panel of the transceiver.

⑬ [16/9] Key

The [16/9] key on the microphone function the same as the [16/9] key on the front panel of the transceiver.

Immediately recalls channel 16 from any channel location. Holding down this key recalls channel 9. Pressing the [16/9] key again reverts to the previous selected working channel.

10 BASIC OPERATION

10.1 RECEPTION

1. After the transceiver has been installed, ensure that the power supply and antenna are properly connected.
2. Press and hold the **VOL/PWR** knob until the radio turns on.
3. Turn the **SQL** knob fully counterclockwise. This state is known as “squelch off”.
4. Turn up the **VOL** knob until noise or audio from the speaker is at a comfortable level.
5. Turn the **SQL** knob clockwise until the random noise disappears. This state is known as the “squelch threshold.”
6. Turn the **CHANNEL** selector knob to select the desired channel. Refer to the channel chart on page 89 for available channels.
7. When a message is received, adjust the volume to the desired listening level. The “**BUSY**” indicator in the LCD is displayed indicating that the channel is being used.

10.2 TRANSMISSION

1. Perform steps 1 through 6 of RECEPTION.
2. Before transmitting, monitor the channel to ensure it is clear.
THIS IS AN FCC REQUIREMENT!
3. Press the **PTT** (push-to-talk) switch. The “**TX**” indicator in the LCD is displayed.
4. Speak slowly and clearly into the microphone.
5. When the transmission is finished, release the **PTT** switch.

NOTE

This is a noise-canceling microphone. The oval slot on the bottom of microphone should be positioned within 1/2 inch (1.3 cm) from the mouth for optimum performance.

10.3 TRANSMIT TIME - OUT TIMER (TOT)

When the **PTT** switch on the microphone is held down, transmit time is limited to 5 minutes. This limits unintentional transmissions due to a stuck microphone. About 10 seconds before automatic transmitter shutdown, a warning beep will be heard from the speaker(s). The transceiver will automatically go to receive mode, even if the **PTT** switch is continually held down. Before transmitting again, the **PTT** switch must first be released and then pressed again.



10.4 SIMPLEX/DUPLEX CHANNEL USE

Refer to the VHF MARINE CHANNEL CHART (page 89) for instructions on use of simplex and duplex channels.

NOTE

All channels are factory-programmed in accordance with International, Industry Canada (Canada), and FCC (USA) regulations. Mode of operation cannot be altered from simplex to duplex or vice-versa.

10.5 INTERNATIONAL, USA, AND CANADA MODE

1. To change the modes, hold the [**16/9**] key and press the [**WX**] key. The mode changes from International to Canadian to USA with each press of the [**WX**] key.
2. “**INTL**” will be displayed for International mode, “**CAN**” will be displayed for Canadian mode, and “**USA**” will be displayed on the LCD for USA mode.
3. Refer to the VHF MARINE CHANNEL CHART (page 89) for allocated channels in each mode.

10.6 NOAA WEATHER CHANNELS

NOTE

NOAA Weather channels are available in the waters of USA and Canada only.

1. To receive a NOAA weather channel, press the [**WX**] key from any channel. The transceiver will go to the last selected weather channel.
2. Turn the **CHANNEL** selector knob on the radio or [**UP(▲)**] / [**DOWN(▼)**] keys on the microphone to select a different NOAA weather channel.
3. To exit from the NOAA weather channels, press the [**WX**] key. The transceiver returns to the channel it was on prior to a weather channel.

10.6.1 NOAA Weather Alert

In the event of extreme weather disturbances, such as storms and hurricanes, the NOAA (National Oceanic and Atmospheric Administration) sends a weather alert accompanied by a 1050 Hz tone and subsequent weather report on one of the NOAA weather channels. When the Weather Alert feature is enabled (see section “**12.10 WX ALERT**”), the transceiver is capable of receiving this alert if the following is performed:

1. Program NOAA weather channels into the transceiver’s memory for scanning. Follow the same procedure as for regular channels under section “**10.12 SCANNING**.”
2. Press the [**SCAN(MEM)**] key once to start memory scanning or priority scanning (determined from the “**12.7 SCAN TYPE**” section, see page 62 for



details).

3. The programmed NOAA weather channels will be scanned along with the regular-programmed channels. However, scanning will not stop on a normal weather broadcast unless a NOAA alert is received.
4. When an alert is received on a NOAA weather channel, scanning will stop and the transceiver will emit a loud beep to alert the user of a NOAA broadcast.
5. Press the [WX] key to stop the alert tone and receive the weather report.

NOTE

If the [WX] key is not pressed the alert tone will be emitted for 5 minutes and then the weather report will be received.

NOTE

The Weather Alert feature is also engaged while the transceiver is receiving on one of the NOAA weather channels.

10.6.2 NOAA Weather Alert Testing

NOAA tests the alert system every Wednesday between 11AM and 1PM. To test the GX3000S's NOAA Weather alert feature, on Wednesday between 11AM and 1PM, setup as in previous section and confirm the alert is heard.

10.7 EMERGENCY (CHANNEL 16 USE)

Channel 16 is known as the Hail and Distress Channel. An emergency is defined as a threat to life or property. In such instances, be sure the transceiver is on and set to CHANNEL 16. Then use the following procedure:

1. Press the microphone push-to-talk switch and say "**Mayday, Mayday, Mayday**. This is _____, _____, _____" (your vessel's name).
2. Then repeat once: "**Mayday, _____**" (your vessel's name).
3. Now report your position in latitude/longitude, or by giving a true or magnetic bearing (state which) to a well-known landmark such as a navigation aid or geographic feature such as an island or harbor entry.
4. Explain the nature of your distress (sinking, collision, aground, fire, heart attack, life-threatening injury, etc.).
5. State the kind of assistance your desire (pumps, medical aid, etc.).
6. Report the number of persons aboard and condition of any injured.
7. Estimate the present seaworthiness and condition of your vessel.
8. Give your vessel's description: length, design (power or sail), color and other distinguishing marks. The total transmission should not exceed 1 minute.
9. End the message by saying "**OVER.**" Release the microphone button and listen.
10. If there is no answer, repeat the above procedure. If there is still no response, try another channel.

10.8 CALLING ANOTHER VESSEL (CHANNEL 16 OR 9)

Channel 16 may be used for initial contact (hailing) with another vessel.

However, its most important use is for emergency and distress messages. This channel must be monitored at all times except when actually using another channel.

It is monitored by the U.S. and Canadian Coast Guards and by other vessels.

Use of channel 16 for hailing must be limited to initial contact only. Calling should not exceed 30 seconds, but may be repeated 3 times at 2-minute intervals. In areas of heavy radio traffic, congestion on channel 16 resulting from its use as a hailing channel can be reduced significantly in U.S. waters by using **channel 9** as the initial contact (hailing) channel for non-emergency communications. Here, also, calling time should not exceed 30 seconds but may be repeated 3 times at 2-minute intervals.

Prior to making contact with another vessel, refer to the channel charts in this manual, and select an appropriate channel for communications after initial contact. For example, Channels 68 and 69 are some of the channels available to non-commercial (recreational) boaters. Monitor your desired channel in advance to make sure you will not be interrupting other traffic, and then go back to either channel 16 or 9 for your initial contact.

When the hailing channel (16 or 9) is clear, state the name of the other vessel you wish to call and then **“this is”** followed by the name of your vessel and your Station License (Call Sign). When the other vessel returns your call, immediately request another channel by saying **“go to,”** the number of the other channel, and **“over.”** Then switch to the new channel. When the new channel is not busy, call the other vessel.

After a transmission, say **“over,”** and release the microphone’s push-to-talk (PTT) switch. When all communication with the other vessel is completed, end the last transmission by stating your Call Sign and the word **“out.”** Note that it is not necessary to state your Call Sign with each transmission, only at the beginning and end of the contact.

Remember to return to Channel 16 when not using another channel. Some radios automatically monitor Channel 16 even when set to other channels or when scanning.

10.9 MAKING TELEPHONE CALLS

To make a radiotelephone call, use a channel designated for this purpose, The fastest way to learn which channels are used for radiotelephone traffic is to ask at a local marina. Channels available for such traffic are designated **Public Correspondence** channels on the channel charts in this manual. Some ex-



amples for USA use are Channels 24, 25, 26, 27, 28, 84, 85, 86, and 87. Call the marine operator and identify yourself by your vessel's name, The marine operator will then ask you how you will pay for the call (telephone credit card, collect, etc.) and then link your radio transmission to the telephone lines.

The marine telephone company managing the VHF channel you are using may charge a link-up fee in addition to the cost of the call.

10.10 OPERATING ON CHANNELS 13 AND 67

Channel 13 is used at docks and bridges and by vessels maneuvering in port. Messages on this channel must concern navigation only, such as meeting and passing in restricted waters.

Channel 67 is used for navigational traffic between vessels.

By regulation, power is normally limited to 1 Watt on these channels. Your radio is programmed to automatically reduce power to this limit on these channels. However, in certain situations it may be necessary to temporarily use a higher power. See page 20 ([H/L(NAV)] key) for means to temporarily override the low-power limit on these two channels.

10.11 DUAL WATCH (TO PRIORITY CHANNEL)

Dual watch allows the radio to monitor one channel and the assigned Priority channel. By default the priority channel is set to 16, however the priority channel may be changed by referring to section "12.6 PRIORITY CHANNEL SET."

1. Adjust the **SQL** knob until the background noise disappears.
2. Select the channel you wish to dual watch to "Priority channel."
3. Press the **[DW(IC)]** key.

The display will scan between Priority channel and the channel that was selected in step 2.

If a transmission is received on the channel selected in step 2, the **GX3000S** will dual watch between the working channel and the Priority channel.

4. To stop Dual Watch, press the **[DW(IC)]** key again.



10.12 SCANNING

Allows the user to select the scan type from Memory scan or Priority scan. "Memory scan" scans the channels that were programmed into memory. "Priority scan" scans the channels programmed in memory with the priority channel.

10.12.1 Selecting the Scan Type

1. Press and hold down the [CALL(MENU)] key until "Radio Setup" menu appears.
2. Press the [ENT] key, then select "SCAN Type" in the "Radio Setup" menu with the **CHANNEL** selector knob.
3. Press the [ENT] key.
4. Turn the **CHANNEL** selector knob to select "Priority" or "Memory."
5. Press the [ENT] key to store the selected setting.
6. To exit this menu and return to radio operation mode press the [16/9] key.



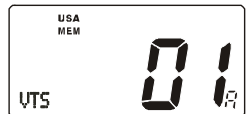

10.12.2 Memory Scanning (M-SCAN)

1. Adjust the **SQL** knob until background noise disappears.
2. Select a desired channel to be scanned using the **CHANNEL** selector knob. Press and hold the [SCAN(MEM)] key for one second, "MEM" will appear on the LCD which indicates the channel has been programmed into the transceivers memory.
3. Repeat step 2 for all the desired channels to be scanned.
4. To DELETE a channel from the transceiver's memory, select the channel then press and hold the [SCAN(MEM)] key for one second, "MEM" will disappear in the LCD.
5. To start scanning, just press the [SCAN(MEM)] key momentarily. "M-SCAN" appears on the LCD. Scanning will proceed from the lowest to the highest programmed channel number and will stop on a channel when a transmission is received.
6. The channel number will blink during reception.
7. To stop scanning, press the [16/9] or [WX] key.



10.12.3 Priority Scanning (P-SCAN)

In the default setting, Channel 16 is set as the priority channel. You may change the priority channel to the desired channel from the Channel 16 by the Radio Setup Mode, refer to section “12.6 PRIORITY CHANNEL SET.”

1. Adjust the **SQL** knob until background noise disappears.
2. Select a desired channel to be scanned using the **CHANNEL** selector knob. Press and hold the [**SCAN(MEM)**] key for one second, “**MEM**” will appear on the display which indicates the channel has been programmed into the transceivers memory. 
3. Repeat step 2 for all the desired channels to be scanned.
4. To **DELETE** a channel from the transceiver’s memory, select the channel then press and hold the [**SCAN(MEM)**] key until “**MEM**” is removed from the display.
5. To start priority scanning, press the [**SCAN(MEM)**] key momentarily. “**P-SCAN**” appears on the LCD. Scanning will proceed between the memorized channels and the priority channel. The priority channel will be scanned after each programmed channel. 
6. To stop scanning, press the [**16/9**] or [**WX**] key.

You may change the scan resume time in the Radio Setup Mode, refer to section “12.8 SCAN RESUME TIME.”

10.13 PA/FOG OPERATION

PA/FOG mode allows the transceiver to be used as a 30W hailer when an optional STANDARD HORIZON 220SW or 240SW PA horn speaker is installed. When in Hail mode the PA speaker Listen's Back (acts as a microphone and amplifies sound to the front panel speaker) through the PA horn speaker which provides two-way communications through the PA horn speaker.

NOTE

When in PA or FOG mode the **GX3000S** will receive on the last selected VHF channel before entering into the PA or FOG mode and receive DSC calls.

PA HAIL mode:

PA HAIL mode allows the transceiver to be used as a power hailer when an optional STANDARD HORIZON 220SW or 240 SW HAIL/PA speaker is installed. The Hail mode has a listen-back feature which provides two way communication through the HAIL/PA speaker.

FOG HORN mode:

Automatic signaling is transmitted through the HAIL/PA speaker.

10.13.1 Operating the PA HAIL mode

1. Press the **[PA/FOG]** key, then select "PA" with the **CHANNEL** selector knob.
2. Press the **[ENT]** key.
3. Press the **PTT** switch to speak through the HAIL/PA speaker.

Rotate the **CHANNEL** selector knob to control the AF output level. The AF output level can be set from 0 to 30 watts.

4. To exit the PA HAIL mode, press the **[PA/FOG]** or **[CLR]** key.

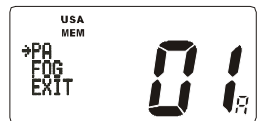

10.13.2 Operating the FOG HORN mode

Operator can select from "Underway," "Stop," "Sail," "Tow," "Aground," "Anchor," "Horn," or "Siren." Please refer to page 98 for FOG Horn Timing Chart.

1. Press the **[PA/FOG]** key, then select "Fog" with the **CHANNEL** selector knob.
2. Press the **[ENT]** key.
3. Turn the **CHANNEL** selector knob to select the one of the eight functions described above.
4. Press the **[CALL/SET(MENU)]** key.
5. On the "Horn" and "Siren" modes, press the **PTT**

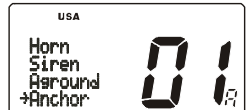

switch to activate the tone through the HAIL/PA speaker.

Rotate the **CHANNEL** selector knob to control the AF output level. The AF output level can be set from 0 to 30 watts.

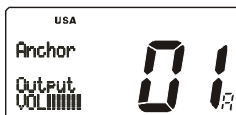

- To exit the FOG HORN mode, press the [PA/FOG] or [CLR] key.

10.14 NAVIGATION INDICATION

The transceiver has the ability to display Time, SOG, COG, as well as the position (LAT/LON), when connected to a GPS receiver.

- Press and hold the [H/L(NAV)] key, display the position information on the LCD. If the GPS receiver is not receiving a fix, the display will be as shown in the illustration on the right.

NOTE: When Ch16 is selected only lat/lon will shown.

- To hide the position information, press and hold the [H/L(NAV)] key again.

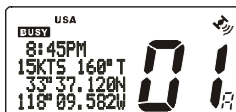

10.15 INTERCOM OPERATION

Connecting a **CMP25 RAM+** or **VH-310** handset to the **GX3000S** allows intercom communications. Refer to section “13.3 INTERCOM OPERATION” for **CMP25 RAM+** Microphone or section “14.3 INTERCOM OPERATION” for **VH-310** Handset.

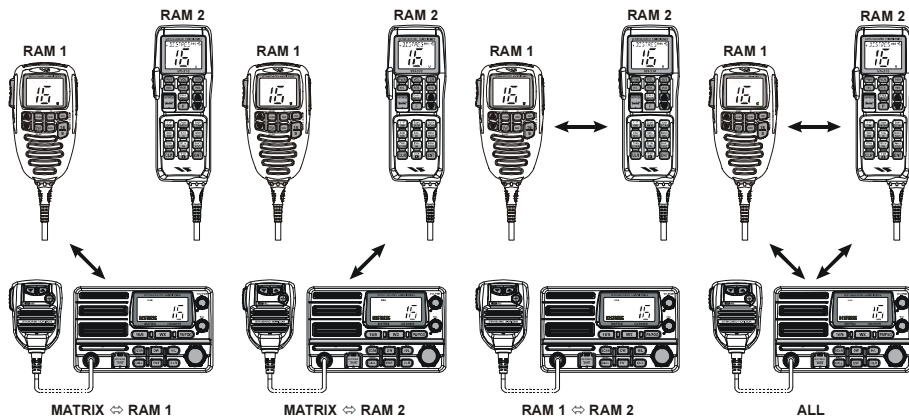

10.15.1 Communication

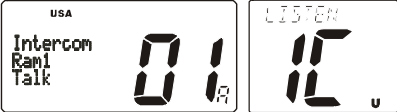
1. Press and hold the **[DW(IC)]** key, the mode is changed to “INTERCOM” mode.
2. If your **GX3000S** is equipped with two **CMP25 RAM+** Mic’s (or **VH-310 Handset**), select the companion you wish to communicate (Ram1, Ram2, or ALL) with the **CHANNEL** selector knob, then press the **[ENT]** key.
3. When the “INTERCOM” is activated, “Intercom” is displayed on the **GX3000S**, and “IC” is displayed on the **CMP25 RAM+** Mic or **VH-310 Handset**.
4. Press the **PTT** switch. “Talk” will be shown on the display.

NOTE: A warning beep will be emitted when the **GX3000S** microphone’s **PTT** switch is pressed while the **RAM+** Mic’s or **VH-310 Handset**’s **PTT** switch is pressed.



(**GX3000S**’s **PTT** switch is pressed)

(Second Station Mic’s **PTT** switch is pressed)
5. Speak slowly and clearly into the microphone, hold the microphone about 1/2 inch away from your mouth.
6. When finished, release the **PTT** switch.
7. To exit the “INTERCOM” mode and return to radio operation mode, press the **[16/9]** or **[CLR]** key.

10.15.2 Calling

While in INTERCOM mode, pressing and holding the **[DW(IC)]** key on the **GX3000S**, **CMP25**, or **VH-310** will produce a calling beep at the other station.

NOTE

When both **CMP25 RAM+** microphones (or **VH-310 Handset**) are intercom mode, the **GX3000S** will be temporarily disabled until the **RAM+(s)** exit the **RAM+** to **RAM+** intercom mode.

10.16 VOICE SCRAMBLER

If privacy of communications is desired, a **CVS2500** voice scrambler (VS) can be installed in the transceiver. Contact your Dealer to have a **CVS2500** installed. Refer to the section **12.11 VOICE SCRAMBLER** to program the voice scrambler.

1. Turn on the transceiver.
2. Select a channel that was programmed for scrambler mode (“**VS**” will appear on the LCD).
 - If a channel is not set for the voice scrambler, the display will be as shown in the illustration at the right (“**VS**” will disappear from the LCD).
 - If a voice scrambler is canceled temporarily in the “**SETUP**” menu, the display will be as shown in the illustration at the right.
3. Monitor the channel before transmitting.
4. Transmit the voice message. The signal sent will be scrambled.

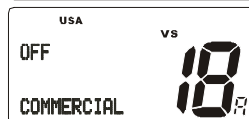
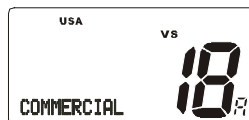

11 DIGITAL SELECTIVE CALLING

11.1 GENERAL

WARNING

This radio is designed to generate a digital maritime distress and safety call to facilitate search and rescue. To be effective as a safety device, this equipment must be used only within communication range of a shore-based VHF marine channel 70 distress and safety watch system. The range of signal may vary but under normal conditions should be approximately 20 nautical miles.

NOTE

A DSC Warning sticker is included with the **GX3000S**. To comply with FCC regulations this sticker must be mounted in a location that can be easily viewed from the location of the **GX3000S**. Make sure the chosen location is clean and dry before applying the sticker.

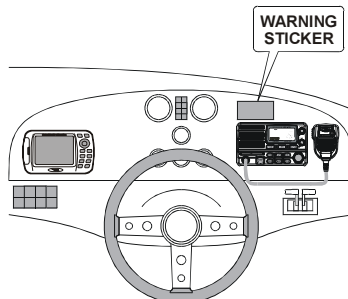

Digital Selective Calling is a semi-automated method of establishing a radio call, it has been designated by the International Maritime Organization (IMO) as an international standard for establishing VHF, MF, and HF radio calls. It has also been designated as part of the Global Maritime Distress and Safety System (GMDSS). It is planned that DSC will eventually replace aural watches on distress frequencies and will be used to announce routine and urgent maritime safety information broadcasts.

This system allows mariners to instantly send a distress call with GPS position (when connected to the transceiver) to the Coast Guard and other vessels within range of the transmission. DSC will also allow mariners to initiate or receive Distress, Urgency, Safety, Routine, POSITION REQUEST, POSITION SEND, and Group calls to or from another vessel equipped with a DSC transceiver.

11.2 MARITIME MOBILE SERVICE IDENTITY (MMSI)

11.2.1 What is an MMSI?

An MMSI is a nine digit number used on Marine Transceivers capable of using Digital Selective Calling (DSC). This number is used like a telephone number to selectively call other vessels.

THIS NUMBER MUST BE PROGRAMMED INTO THE RADIO TO OPERATE THE GX3000S DSC FUNCTIONS.

How can I obtain an MMSI assignment?

Boat US offers online registration of a MMSI. Visit www.boatus.com/mmsi

11.2.2 Programming the MMSI

WARNING

User MMSI can be input only twice. If the user tries to input an MMSI more than twice, the radio will show the display on the right. If the user needs to change the MMSI more than twice, the transceiver will have to be sent to Factory Service. Refer to the section “15.2. FACTORY SERVICE.”



1. Press and hold down the [CALL(MENU)] key until the “Radio Setup” menu appears.
2. Turn the **CHANNEL** selector knob to the left to select “DSC Setup” menu.
3. Press the [ENT] key, then select “User MMSI” with the **CHANNEL** selector knob.
4. Press the [ENT] key. The display will show a series of dashes or the last MMSI number if programmed.
5. Turn the **CHANNEL** selector knob or press the [UP(▲)] / [DOWN(▼)] key on the microphone to select the first number of your MMSI, then press the [ENT] key to step to the next number.
6. Repeat step 5 to set your MMSI (up to nine digits).
7. When finished programming the number, press and hold the [ENT] key to store the number in memory.
8. To exit this menu and return to radio operation mode press the [16/9] key.

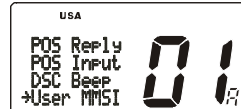

11.3 DSC DISTRESS CALL

The **GX3000S** is capable of transmitting and receiving DSC Distress messages to all DSC radios. The **GX3000S** may be connected to a GPS to also transmit the Latitude, Longitude of the vessel.

11.3.1 Transmitting a DSC Distress Call

NOTE

To be able to transmit a DSC distress call an MMSI number must be programmed, refer to section “11.2.2 Programming the MMSI.”

In order for your ships location to be transmitted a GPS must be connected to the **GX3000S**, refer to section “8.3 ACCESSORY CABLE.”

1. Lift the red spring loaded DISTRESS cover and press the **[DISTRESS]** key. The “DISTRESS” menu will appear on the LCD.
2. Press and hold the **[DISTRESS]** key. The radios display will count down (3-2-1) and then transmit the Distress call.
3. When the distress signal is sent, CH70 and “**TX**” icon will appear on the LCD. After the message has been sent, the radio will sound a Distress Alarm.
4. The transceiver will watch for a DSC acknowledgment transmission on CH70 and also receive calls on CH16.
5. If an acknowledgement is received, select channel 16 and advise your distress situation.
6. If no acknowledgment is received, the distress call is repeated in 4 minute intervals until a DSC acknowledgment is received.
7. When a DSC Distress acknowledgment is received, a distress alarm sounds and channel 16 is automatically selected. The LCD shows the MMSI of the ship responding to your distress.
RECEIVED ACK: acknowledgment signal is received.
RECEIVED RLY: relay signal is received from another vessel or coast station.
8. To cancel the DSC distress alarm signal from the speaker, press any key.

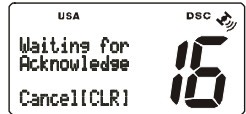
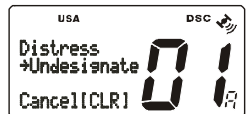

Transmitting a DSC Distress Call with Nature of Distress

The **GX3000S** is capable of transmitting a DSC Distress Call with the following “Nature of Distress” categories:

Undesignated, Fire, Flooding, Collision, Grounding, Capsizing, Sinking, Adrift, Abandoning, Piracy, MOB

1. Lift the red spring loaded DISTRESS cover and press the **[DISTRESS]** key. The “DISTRESS” menu will appear on the LCD.
2. Turn the **CHANNEL** selector knob to select the desired nature of distress category.
3. Press and hold the **[DISTRESS]** key. The radios display will count down (3-2-1) and then transmit the Distress call.
4. When the distress signal is sent, CH70 and “**TX**” icon will appear on the LCD. After the message has been sent, the radio will sound a Distress Alarm.
5. The transceiver will watch for a DSC acknowledgment transmission on CH70 and also receive calls on CH16.
6. If an acknowledgement is received, select channel 16 and advise your distress situation.
7. If no acknowledgment is received, the distress call is repeated in 4 minute intervals until a DSC acknowledgment is received.
8. When a DSC Distress acknowledgment is received, a distress alarm sounds and channel 16 is automatically selected. The LCD shows the MMSI of the ship responding to your distress.
RECEIVED ACK: acknowledgment signal is received.
RECEIVED RLY: relay signal is received from another vessel or coast station.
9. To cancel the DSC distress alarm signal from the speaker, press any key.

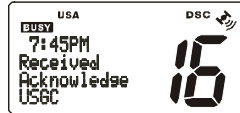
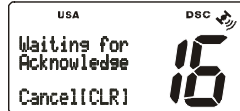
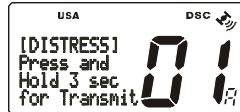
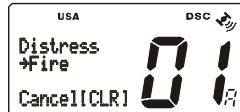
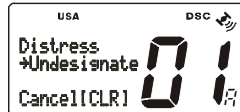

Cancel a DSC Distress Call

If a DSC Distress call was sent by error the **GX3000S** allows you to send a message to other vessels to cancel the Distress Call that was made in error.

Press the **[CLR]** key, then press the **[ENT]** key.

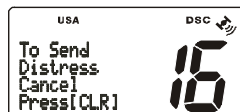

11.3.2 Receiving a DSC Distress Call

1. When a DSC Distress call is received, an emergency alarm sounds.
Then channel 16 is automatically selected.
2. Press any key to stop the alarm.
3. Turn the **CHANNEL** selector knob to change the display to show the position of the vessel in distress.
4. If the position of the vessel distress data does not include position, the LCD will show the display on the right.



NOTE

You must continue monitoring channel 16 as a coast station may require assistance in the rescue attempt.

11.4 ALL SHIPS CALL

The All Ships Call function allows contact to be established with other vessel stations without having their ID in the individual calling directory. Also, priority for the call can be designated as Agency or Safety.

URGENCY Call: This type of call is used when a vessel may not truly be in distress, but have a potential problem that may lead to a distress situation. This call is the same as saying PAN PAN PAN on channel 16.

SAFETY Call: Used to transmit boating safety information to other vessels. This message usually contains information about an overdue boat, debris in the water, loss of a navigation aid or an important meteorological message. This call is the same as saying Securite, Securite, Securite.”

11.4.1 Transmitting an All Ships Call

1. Press the [CALL(MENU)] key. The "DSC Operation" menu will appear.
2. Turn the **CHANNEL** selector knob to select "All Ships."
3. Press the [ENT] key. (To cancel, turn the **CHANNEL** selector knob to select "Exit.")
4. Turn the **CHANNEL** selector knob to select the call ("Ugency" or "Safety").
5. Press the [ENT] key to transmit the selected type of all ships DSC call.
6. After the ALL SHIPS CALL is transmitted, the transceiver will switch to CH16.
7. Listen to the channel to make sure it is not busy, then key the microphone and say PAN PAN PAN or "Securite, Securite, Securite" depending on the priority of the call. Say your call sign and announce the channel you wish to switch to for communications.

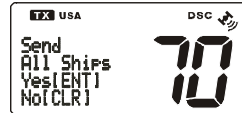
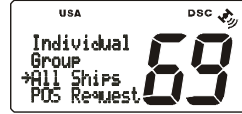

11.4.2 Receiving an All Ships Call

1. When an all ships call is received, an emergency alarm sounds.
The radio will automatically change to channel 16.
2. Press any key to stop the alarm.
3. Turn the **CHANNEL** selector knob to see the MMSI of the vessel transmitting the All Ships Call.
4. Monitor channel 16 or traffic channel until the URGENCY voice communication is completed.

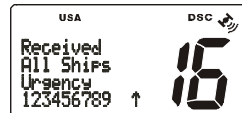

11.5 INDIVIDUAL CALL

This feature allows the **GX3000S** to contact another vessel with a DSC VHF radio and automatically switch the receiving radio to a desired communications channel. This feature is similar to calling a vessel on CH16 and requesting to go to another channel (switching to the channel is private between the two stations).

11.5.1 Setting up the Individual / Position Call Directory

The **GX3000S** has a DSC directory that allows you to store a vessel or person's name and the MMSI number associated with vessels you wish to transmit Individual calls, Position Requests and Position Send transmissions.

To transmit an Individual call you must program this directory with information of the persons you wish to call, similar to a cellular phones telephone directory.

1. Press and hold down the **[CALL(MENU)]** key until "Radio Setup" menu appears.
2. Turn the **CHANNEL** selector knob to select "DSC Setup" menu.
3. Press the **[ENT]** key, then select "INDIV DIR" with the **CHANNEL** selector knob.
4. Press the **[ENT]** key, then select "Add" with the **CHANNEL** selector knob.
5. Press the **[ENT]** key.
6. Turn the **CHANNEL** selector knob to scroll through the first letter of the name of the vessel or person you want to reference in the directory.
7. Press the **[ENT]** key to store the first letter in the name and step to the next letter to the right.
8. Repeat step 6 and 7 until the name is complete. The name can consist of up to eleven characters, if you do not use all eleven characters press the **[ENT]** key to move to the next space. This method can also be used to enter a blank space in the name. To clear the previous letter, press the **[CLR]** key.
9. After the eleventh letter or space has been entered, press and hold the **[ENT]** key to advance to the MMSI Maritime Mobile Service Identity Number number entry.
10. Turn the **CHANNEL** selector knob to scroll through numbers, 0-9. To enter the desired number and move one space to the right press the **[ENT]** key. Repeat this procedure until all nine space of the MMSI number are entered.

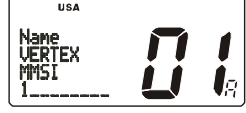
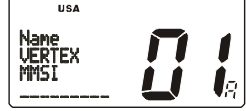
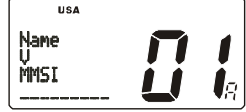

11. If a mistake was made entering in the name or the MMSI number repeat pressing the **[H/L(NAV)]** key until the wrong character is selected, then move the channel knob to correct the entry.
12. To store the data entered, press and hold the **[ENT]** key.
13. To enter another individual address, repeat steps 4 through 12.
14. To exit this menu and return to radio operation mode press the **[16/9]** key.

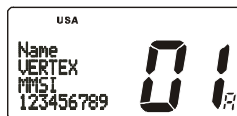

NOTE

Selecting "Next" or "Exit" will automatically save the name and MMSI number into memory.

11.5.2 Setting up Individual Reply

Allows setting up the radio to automatically (default setting) or manually respond to a DSC Individual call requesting you to switch to a working channel for voice communications. When Manual is selected the MMSI of the calling vessel is shown allowing you to see who is calling. This function is similar to caller id on a cellular phone.

1. Press and hold down the **[CALL(MENU)]** key until "Radio Setup" menu appears.
2. Turn the **CHANNEL** selector knob to select "DSC Setup" menu.
3. Press the **[ENT]** key, then select "INDIV Reply" with the **CHANNEL** selector knob.
4. Press the **[ENT]** key.
5. Turn the **CHANNEL** selector knob to select "Auto" or "Manual."
6. Press the **[ENT]** key to store the selected setting.
7. To exit this menu and return to radio operation mode press the **[16/9]** key.

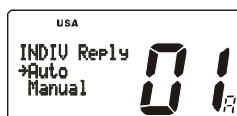

11.5.3 Setting up the Individual/Group Call Ringer

When a Individual Call or Group Call is received the radio will produce a ringing tone for 3 minutes. This selection allows the Individual Call ringer time to be changed.

1. Press and hold down the [**CALL(MENU)**] key until “Radio Setup” menu appear.
2. Turn the **CHANNEL** selector knob to select “DSC Setup” menu.
3. Press the [**ENT**] key, then select “INDIV Ring” with the **CHANNEL** selector knob.
4. Press the [**ENT**] key.
5. Turn the **CHANNEL** selector knob to select ringing time of a Individual Call.
6. Press the [**ENT**] key to store the selected setting.
7. To exit this menu and return to radio operation mode press the [**16/9**] key.

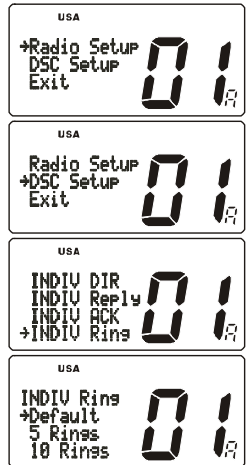

The **GX300S** has the capability to turn off the Individual call ringer.

1. Press and hold down the [**CALL(MENU)**] key until “Radio Setup” menu appear.
2. Turn the **CHANNEL** selector knob to select “DSC Setup” menu.
3. Press the [**ENT**] key, then select “DSC Beep” with the **CHANNEL** selector knob.
4. Press the [**ENT**] key.
5. Turn the **CHANNEL** selector knob to select “Individual” if you wish to disable the Individual Call ringer, or “Group” if you wish to disable the Group Call ringer and press the [**ENT**] key.
6. Turn the **CHANNEL** selector knob to select “Off.”
7. Press the [**ENT**] key to store the selected setting.
8. To exit this menu and return to radio operation mode press the [**16/9**] key.

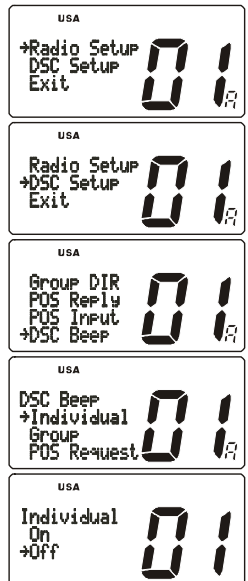

If you wish to return to enabling the ringer tone, just repeat the above procedure, turning the **CHANNEL** selector knob to select “On” in step “6” above.

11.5.4 Transmitting an Individual Call

This feature allows the user to contact another vessel with a DSC radio. This feature is similar to calling a vessel on CH16 and requesting to go to another channel.

Pre-Programmable Calling

1. Press the [**CALL(MENU)**] key. The “DSC Operation” menu will appear.
2. Turn the **CHANNEL** selector knob to select “Individual.” (To cancel, select “Exit” with the **CHANNEL** selector knob or press the [**16/9**] key.)
3. Press the [**ENT**] key. The transceiver will beep, and the “Individual directory” will appear.
4. Turn the **CHANNEL** selector knob to select the “Individual” you want to contact.
5. Press the [**ENT**] key, then turn the **CHANNEL** selector knob to select the operating channel you want to communicate on and press the [**ENT**] key.
6. Press the [**ENT**] key again to transmit the individual DSC signal.
7. After INDIVIDUAL CALL is transmitted, the transceiver will wait 8 seconds for the acknowledgment. If the reply signal is not received, the transceiver will transmit again.
8. After the second INDIVIDUAL CALL is transmitted, if the reply signal is not received, the display will be as shown in the illustration on the right. To send the call again, press the [**ENT**] key.
9. When an individual call acknowledgment is received, the established channel is automatically changed to the channel which is selected on step 5 above and a ringing tone sounds.
10. Press any key to listen to the channel to make sure it is not busy, then key the microphone and call the other vessel you desire to communicate with.

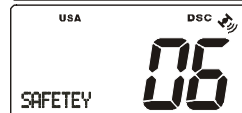
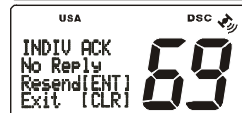
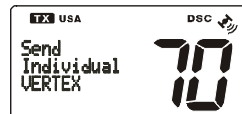
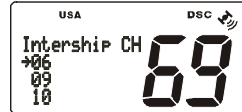

Manual Calling

You may enter an MMSI number manually to contact without the Setting up the Individual Directory.

1. Press the **[CALL(MENU)]** key. The “DSC Operation” menu will appear.
2. Turn the **CHANNEL** selector knob to select “Individual.” (To cancel, select “Exit” with the **CHANNEL** selector knob or press the **[16/9]** key.)
3. Press the **[ENT]** key. The transceiver will beep, and the “Individual directory” will appear.
4. Turn the **CHANNEL** selector knob to select “Manual,” then press the **[ENT]** key.
5. Turn the **CHANNEL** selector knob to scroll through numbers, 0-9. To enter the desired number and move one space to the right press the **[ENT]** key. Repeat this procedure until all nine space of the MMSI number which you want to contact are entered.
6. If a mistake was made entering in the MMSI number repeat pressing the **[H/L(NAV)]** key until the wrong number is selected, then move the channel knob to correct the entry.
7. When finished entering the MMSI number, press and hold the **[ENT]** key.
8. Press the **[ENT]** key, then turn the **CHANNEL** selector knob to select the operating channel you want to communicate on and press the **[ENT]** key.
9. Press the **[ENT]** key again to transmit the individual DSC signal.
10. After INDIVIDUAL CALL is transmitted, the transceiver will wait 8 seconds for the acknowledgment. If the reply signal is not received, the transceiver will transmit again.
11. After the second INDIVIDUAL CALL is transmitted, if the reply signal is not received, the display will be as shown in the illustration on the right. To send the call again, press the **[ENT]** key or to exit the mode, press the **[CLR]** key.
12. When an individual call acknowledgment is received, the established channel is automatically changed to the channel which is selected on step 5 above and a ringing tone sounds.

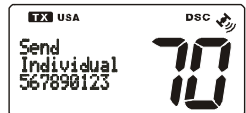
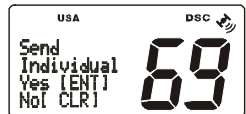
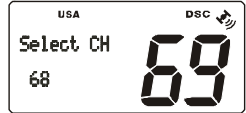
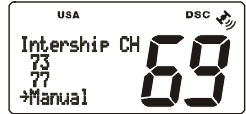
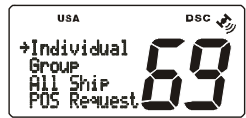

- Press any key to listen to the channel to make sure it is not busy, then key the microphone and call the other vessel you desire to communicate with.

11.5.5 Receiving an Individual Call

When the **GX3000S** receives a individual call, by default the **GX3000S** automatically transmits a acknowledgement before switching to the requested channel. The **GX3000S** can be set so the **GX3000S** prompts you to manually send a reply, refer to section “11.5.2 Setting up Individual Reply.”

- When an individual call is received, an individual call ringing alarm sounds. The radio automatically switches to the requested channel.
- Press any key to stop the alarm.
- Press the **PTT** on the mic and talk to the calling ship.

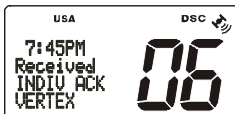

11.6 CALL WAITING DIRECTORY

The **GX3000S** logs received distress calls and individual calls. The DSC Call Waiting feature is similar to an answer machine where calls are this recorded logs for review. When a call is logged while the radio is set on the DSC Standby function, a message will appear on the LCD. The **GX3000S** can be memorized up to the latest 23 Distress and up to the latest 56 Distress Call.

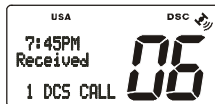

11.6.1 Enabling the Call Waiting Feature

Follow the steps below to enable or disable the Call Waiting feature.

- Press and hold down the [**CALL(MENU)**] key until “Radio Setup” menu appears.
- Turn the **CHANNEL** selector knob to select “DSC Setup” menu.
- Press the [**ENT**] key, then select “INDIV ACK” with the **CHANNEL** selector knob.
- Press the [**ENT**] key.
- Turn the **CHANNEL** selector knob to select “Able” or “Unable.”
- Press the [**ENT**] key to store the selected setting.
- To exit this menu and return to radio operation mode press the [**16/9**] key.

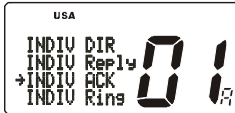

11.6.2 Reviewing Received Calls Logged into the Call Waiting Directory

1. Press the [CALL(MENU)] key. The “DSC Operation” menu will appear.
2. Turn the CHANNEL selector knob to select “DSC Log” menu.
3. Press the [ENT] key, then turn the CHANNEL selector knob to select the category (“Distress” or “DSC Call”) you want to review and call back.
4. Press the [ENT] key, then turn the CHANNEL selector knob to select the station (name or MMIS number) you want to review and call back.
5. Press the [ENT] key, to review details for the selected station.
6. Press the [ENT] key again, to call the selected station.



11.6.3 To Delete the Received Log from the “DSC Log” Directory

1. Press the [CALL(MENU)] key. The “DSC Operation” menu will appear.
2. Turn the CHANNEL selector knob to select “DSC Log” menu.
3. Press the [ENT] key, then turn the CHANNEL selector knob to select “Log Delete.”
4. Press the [ENT] key, then turn the CHANNEL selector knob to select the category (“Distress” or “DSC Call”) to be deleted.
5. Press the [ENT] key, then turn the CHANNEL selector knob to select the station (name or MMIS number) to be deleted.
6. Press and hold the [ENT] key until the station (name or MMIS number) is removed from the display.
7. To exit this menu and return to radio operation mode press the [16/9] key.

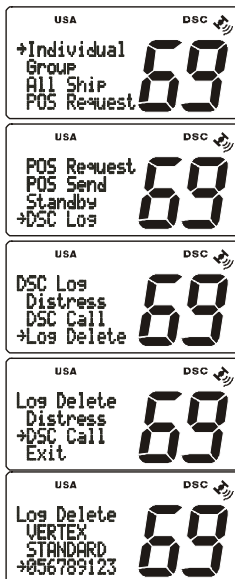

11.7 GROUP CALL

This feature allows the user to contact a group of specific vessels (example members of a yacht club) using DSC radios with Group call function to automatically switch to a desired channel for voice communications.

11.7.1 Setting up a Group Call

For this function to operate the same Group MMSI must be programmed into all the DSC VHF radios within the group of vessels that will be using this feature. The group MMSI is a 9 digit (first digit permanently set to "0") number that will allow other radios to call your vessel along with others to automatically switch to a working channel for voice communications. This function is very useful for yacht clubs and vessels traveling together that want to collectively make announcements on a predetermined channel.

1. Press and hold down the [CALL(MENU)] key until "Radio Setup" menu appears.
2. Turn the **CHANNEL** selector knob to select "DSC Setup" menu.
3. Press the [ENT] key, then select "Group DIR" with the **CHANNEL** selector knob.
4. Press the [ENT] key, then select "Add" with the **CHANNEL** selector knob.
5. Press the [CALL(MENU)] key.
6. Turn the **CHANNEL** selector knob to scroll through the first letter of the name of the vessel or person you want to reference in the directory.
7. Press the [ENT] key to store the first letter in the name and step to the next letter to the right.
8. Repeat step 6 and 7 until the name is complete. The name can consist of up to eleven characters, if you do not use all eleven characters press the [ENT] key to move to the next space. This method can also be used to enter a blank space in the name. To clear the previous letter, press the [CLR] key.
9. After the eleventh letter or space has been entered, press and hold the [ENT] key to advance to the MMSI (Maritime Mobile Service Identity Number) number entry.
10. Turn the **CHANNEL** selector knob to scroll through numbers, 0-9. To enter the desired number and move one space to the right press the [ENT] key. Repeat this procedure until all nine space of the MMSI number are entered.

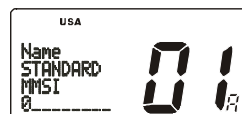
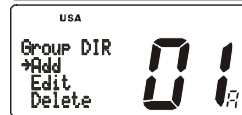
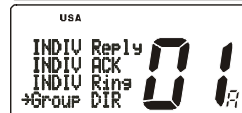

11. If a mistake was made entering in the name or the MMSI number repeat pressing the **[H/L(NAV)]** key until the wrong character is selected, then move the channel knob to correct the entry.
12. To store the data entered, press and hold the **[ENT]** key.
13. To enter another individual address, repeat steps 4 through 12.
14. To exit this menu and return to radio operation mode press the **[16/9]** key.



11.7.2 Transmitting a Group Call

Pre-Programmable Calling

1. Press the **[CALL(MENU)]** key. The “DSC Operation” menu will appear.
2. Turn the **CHANNEL** selector knob to select “Group.” (To cancel, select “Exit” with the **CHANNEL** selector knob or press **[16/9]** key.)
3. Press the **[ENT]** key. The transceiver will beep, and the “Group Directory” will appear.
4. Turn the **CHANNEL** selector knob to select the “Group” you want to contact.
5. Press the **[ENT]** key, then turn the **CHANNEL** selector knob to select the operating channel you want to communicate on and press the **[ENT]** key.
6. Press the **[ENT]** key again to transmit the Group Call signal.
7. After the GROUP CALL is transmitted, all the radios in the group will switch to the designated channel.
8. Listen to the channel to make sure it is not busy, then key the microphone and call the other vessels you desire to communicate with.



Manual Calling

You may enter a Group MMSI number manually to contact without the Setting up the Group call number.

1. Press the **[CALL(MENU)]** key. The “DSC Operation” menu will appear.
2. Turn the **CHANNEL** selector knob to select “Group.” (To cancel, select “Exit” with the **CHANNEL** selector knob or press **[16/9]** key.)
3. Press the **[ENT]** key. The transceiver will beep, and the “Group Directory” will appear.
4. Turn the **CHANNEL** selector knob to select “Manual,” then press the **[ENT]** key.
5. Turn the **CHANNEL** selector knob to scroll through numbers, 0-9. To enter the desired number and move one space to the right press the **[ENT]** key. Repeat this procedure until all nine space of the MMSI number which you want to contact are entered.
6. If a mistake was made entering in the MMSI number repeat pressing the **[H/L(NAV)]** key until the wrong number is selected, then move the channel knob to correct the entry.
7. When finish the entering the MMSI number, press and hold the **[ENT]** key.
8. Press the **[ENT]** key to transmit the Group Call signal.
9. After the GROUP CALL is transmitted, all the radios in the group will switch to the designated channel.
10. Listen to the channel to make sure it is not busy, then key the microphone and call the other vessels you desire to communicate with.

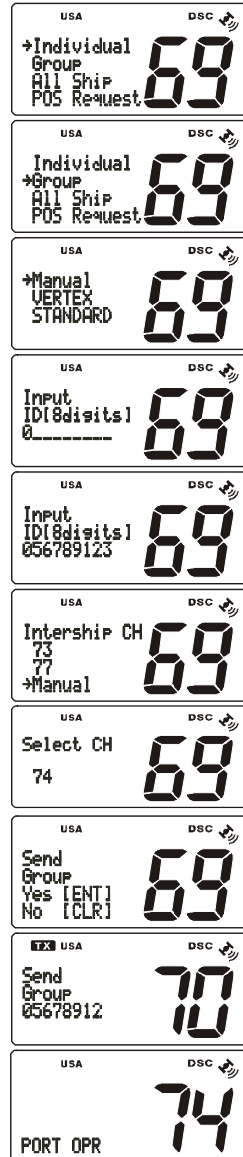

11.7.3 Receiving a Group Call

1. When a group call is received, the **GX3000S** will produce a ringing alarm sound.
2. The radio automatically switches to the requested channel.
3. Press any key to stop the alarm.
4. Monitor the channel for the person calling the Group for a message.
5. If you want to respond, monitor the channel to make sure it is clear, then press the **PTT** on the mic and talk to the calling ship(s).

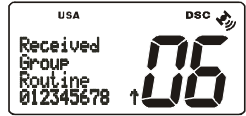
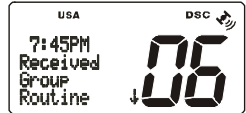

NOTE

After a Group call is received, the time the call was made and the ships MMSI or vessels name will appear on the LCD.

11.8 POSITION REQUEST

Advancements in DSC have made it possible to poll the location of another vessel and show the position of that vessel on the display of the **GX3000S**. Standard Horizon has taken this feature one step further, if any Standard Horizon GPS is connected to the **GX3000S**, the polled position of the vessel is shown on the display of the GPS chart plotter making it easy to navigate to the location of the polled vessel. This is a great feature for anyone wanting to know the position of another vessel. For example your buddy that is catching fish, or finding the location of a person you are cruising with.

NOTE

The other vessel must have an operating GPS receiver connected to its DSC transceiver and must not have its transceiver set to deny position requests. (Refer the section “**11.5.1 Setting up the Individual / Position Call Directory**” to enter information into the individual directory).

11.8.1 Setting up Position Reply

The **GX3000S** can be set up to automatically or manually send your position to another vessel. This selection is important if you are concerned about someone polling the position of your vessel that you may not want to. In the manual mode you will see the MMSI or persons name shown on the display allowing you to choose to send your position to the requesting vessel.

1. Press and hold down the [**CALL(MENU)**] key until “Radio Setup” menu appears.
2. Turn the **CHANNEL** selector knob to select “DSC Setup” menu.
3. Press the [**ENT**] key, then select “POS Reply” with the **CHANNEL** selector knob.
4. Press the [**ENT**] key.
5. Turn the **CHANNEL** selector knob to select “Auto” or “Manual.” In “Auto” mode, after a DSC POS Request is received, the radio will automatically transmit your vessels position. In “Manual” mode, the display of the **GX3000S** will show who is requesting the position.
6. Press the [**ENT**] key to store the selected setting.
7. To exit this menu and return to radio operation mode press the [**16/9**] key.

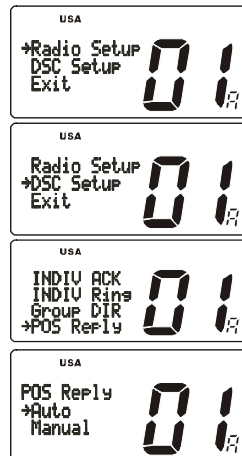

The **GX3000S** has the capability to turn off the Position Request ringer.

1. Press and hold down the **[CALL(MENU)]** key until “Radio Setup” menu appears.
2. Turn the **CHANNEL** selector knob to select “DSC Setup” menu.
3. Press the **[ENT]** key, then select “DSC Beep” with the **CHANNEL** selector knob.
4. Press the **[ENT]** key.
5. Turn the **CHANNEL** selector knob to select “POS Request.”
6. Turn the **CHANNEL** selector knob to select “Off.”
7. Press the **[ENT]** key to store the selected setting.
8. To exit this menu and return to radio operation mode press the **[16/9]** key.

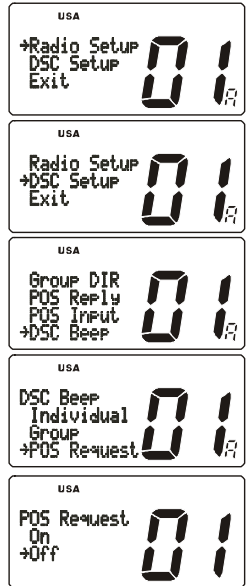

If you wish to return to enabling the ringer tone, just repeat the above procedure, turning the **CHANNEL** selector knob to select “On” in step “6” above.

11.8.2 Transmitting a Position Request to Another Vessel

Pre-Programmable Request

1. Press the **[CALL(MENU)]** key. The “DSC Operation” menu will appear in the display.
2. Turn the **CHANNEL** selector knob to select “POS Request.”
3. Press **[ENT]** key to show the Position request directory. This directory uses the INDIVIDUAL Directory information.
4. Turn the **CHANNEL** selector knob to select a name, then press the **[ENT]** key.
5. Press the **[ENT]** key to transmit the position request DSC call.
6. When the **GX3000S** receives the position from the polled vessel it is shown on the radio display and also transferred to the GPS Chart plotter.
7. If the **GX3000S** does not receive a reply, the display will be as shown in the illustration on the right. To send again, press the **[ENT]** key.

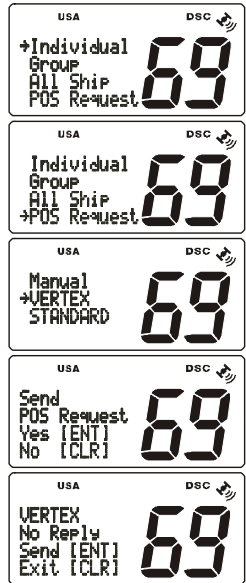

NOTE

If the **GX3000S** does not receive position data from the polled vessel, the LCD will show "NO POSITION DATA."

Manual Request

You may enter an MMSI number manually to contact without the Setting up the Individual / Position Call Directory.

1. Press the **[CALL(MENU)]** key. The "DSC Operation" menu will appear in the display.
2. Turn the **CHANNEL** selector knob to select "POS Request."
3. Press **[ENT]** key to show the Position request directory. This directory uses the INDIVIDUAL Directory information.
4. Turn the **CHANNEL** selector knob to select "Manual," then press the **[ENT]** key.
5. Turn the **CHANNEL** selector knob to scroll through numbers, 0-9. To enter the desired number and move one space to the right press the **[ENT]** key. Repeat this procedure until all nine space of the MMSI number which you want to contact are entered.
6. If a mistake was made entering in the MMSI number repeat pressing the **[H/L(NAV)]** key until the wrong number is selected, then move the channel knob to correct the entry.
7. When finished entering the MMSI number, press and hold the **[ENT]** key.
8. Press the **[ENT]** key to transmit the position request DSC call.
9. When the **GX3000S** receives the position from the polled vessel it is shown on the radio display and also transferred to the GPS Chart plotter.
10. If the **GX3000S** does not receive a reply, the display will be as shown in the illustration on the right. To send again, press the **[ENT]** key.

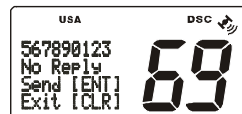
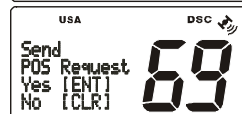
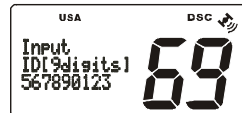
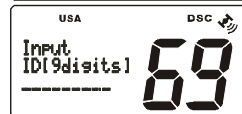
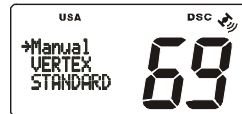
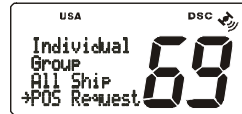

11.8.3 Receiving a Position Request

When a position request call is received from another vessel, a ringing alarm will sound and POS REQUEST will be shown in the LCD. Operation and transceiver function differs depending on “POS Reply” in the “DSC Setup” menu setting.

Automatically reply:

1. When a position request call is received, a calling alarm sounds 4 times. Then requested position coordinates are transmitted automatically to the vessel requesting your vessels position.
2. To exit from position request display, press any key.



Manually reply:

1. When a position request call is received from another vessel, the LCD will be as shown in the illustration at the right.
2. A ringing alarm sounds 4 times. Select type of reply function “Send” or “No Reply” by using the **CHANNEL** selector knob. The **GX3000S** display will show “Send” or “No Reply” allowing you to send your vessels location by using the **CHANNEL** selector knob.
3. When “Send” is selected, press the [ENT] key. And your position will be transmitted to the requesting vessel.
4. To exit from position request display, press the [16/9] key.

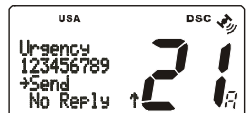

11.9 POSITION SEND

The feature is similar to Position Request, however instead of requesting a position of another vessel this function allows you to send your position to another vessel. Your vessel must have an operating GPS receiver connected for the **GX3000S** to send the position.

11.9.1 Setting up a Position Send Ringer

The **GX3000S** has the capability to turn off the Position Send ringer.

1. Press and hold down the [**CALL(MENU)**] key until “Radio Setup” menu appears.
2. Turn the **CHANNEL** selector knob to select “DSC Setup” menu.
3. Press the [**ENT**] key, then select “DSC Beep” with the **CHANNEL** selector knob.
4. Press the [**ENT**] key.
5. Turn the **CHANNEL** selector knob to select “POS Send.”
6. Turn the **CHANNEL** selector knob to select “Off.”
7. Press the [**ENT**] key to store the selected setting.
8. To exit this menu and return to radio operation mode press the [**16/9**] key.



If you wish to return to enabling the ringer tone, just repeat the above procedure, turning the **CHANNEL** selector knob to select “On” in step “6” above.

11.9.2 Transmitting a DSC Position Send Call

Pre-Programmable Calling

1. Press the [**CALL(MENU)**] key.
The “DSC Operation” menu will appear in the display.
2. Turn the **CHANNEL** selector knob to select the “POS Send.”
3. Press the [**ENT**] key to select the Individual directory.
4. Turn the **CHANNEL** selector knob to select a name in the directory, then press the [**ENT**] key.
5. Press the [**ENT**] key to send your position to the selected vessel.

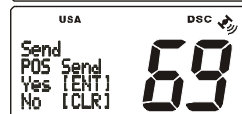
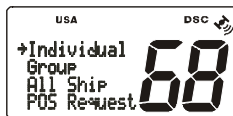

Manual Calling

1. Press the **[CALL(MENU)]** key. The “DSC Operation” menu will appear in the display.
2. Turn the **CHANNEL** selector knob to select the “POS Send.”
3. Press **[ENT]** key to show the Position Send directory. This directory uses the INDIVIDUAL Directory information.
4. Turn the **CHANNEL** selector knob to select “Manual,” then press the **[ENT]** key.
5. Enter the MMSI number (nine digits) which you want to contact, then press the **[ENT]** key.
6. Press the **[ENT]** key to send your position to the selected vessel.

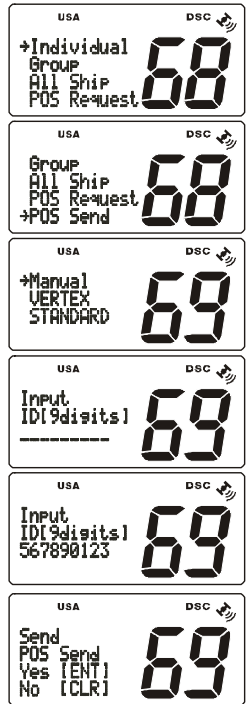

11.9.3 Receiving a DSC Position Send Call

When another vessel transmits their location to the **GX3000S**, the following will happen:

1. A ringing sound will be produced when the call is received.
2. Press the **[16/9]** key to stop ringing
3. The position from the calling vessel will be shown on the display of the radio and also transferred to any Standard Horizon GPS Chart plotter if connected.

11.10 MANUAL INPUTTING GPS LOCATION (LAT/LON)

You may send the Latitude/Longitude of your vessel manually even if the **GX3000S** is not connected the GPS receiver unit.

After the position is entered, transmitting a DSC Distress, Position Request, or Position Send will contain the manually entered position.

1. Press and hold down the [**CALL(MENU)**] key until “Radio Setup” menu appears.
2. Turn the **CHANNEL** selector knob to select “DSC Setup” menu.
3. Press the [**ENT**] key, then select “POS Input” with the **CHANNEL** selector knob.
4. Press the [**ENT**] key. The transceiver will beep, and the display will be as shown in the illustration on the right.
5. Enter the your local time by the 24-hour system on the UTC time. Use the [**ENT**] and [**H/L(NAV)**] key to navigate to each column of the time, then use the **CHANNEL** selector knob to select the desired numbers in each colum. Repeat for each column, to complete the time.
6. Enter the Latitude/Longitude of your vessel location with the same procedure as description above.
7. To store the data entered, press the [**ENT**] key. To exit this menu and return to radio mode press the [**16/9**] key.

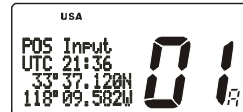
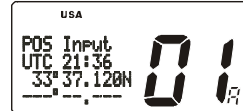
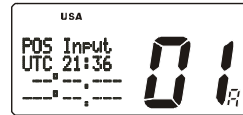
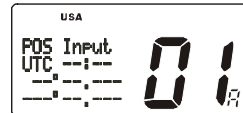
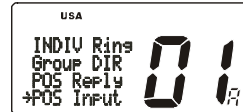

12 RADIO SETUP

NOTE

The optional **CMP25** RAM+ mic and **VH-310** Handset can also change the RADIO SETUP menu. Refer to page 68 (RAM+ mic) and page 74 (**VH-310**) for details.

12.1 LAMP ADJUSTING

Allows setting up the backlight intensity or to turn it off.

1. Press and hold down the [**CALL(MENU)**] key until “Radio Setup” menu appears.
2. Press the [**ENT**] key, then select “Dimmer” in the “Radio Setup” menu with the **CHANNEL** selector knob.
3. Press the [**ENT**] key.
4. Turn the **CHANNEL** selector knob to select the desired level. When “OFF” is selected, the lamp is extinguished.
5. Press the [**ENT**] key to store the selected level.
6. To exit this menu and return to radio operation mode press the [**16/9**] key.

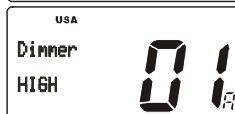

12.2 LCD CONTRAST

This selection sets up the display for best viewability for the varying mounting locations (overhead or below).

1. Press and hold down the [**CALL(MENU)**] key until “Radio Setup” menu appears.
2. Press the [**ENT**] key, then select “Contrast” in the “Radio Setup” menu with the **CHANNEL** selector knob.
3. Press the [**ENT**] key.
4. Turn the **CHANNEL** selector knob to select the desired level. The contrast level can be set from “0” to “31.”
5. Press the [**ENT**] key to store the selected level.
6. To exit this menu and return to radio operation mode press the [**16/9**] key.

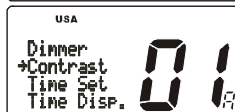

12.3 TIME OFFSET

From the Factory the **GX3000S** shows GPS satellite time or UTC time. A time offset is needed to show the local time in your area.

1. Press and hold down the [**CALL(MENU)**] key until “Radio Setup” menu appears.
2. Press the [**ENT**] key, then select “Time Set” in the “Radio Setup” menu with the **CHANNEL** selector knob.
3. Press the [**ENT**] key.
4. Turn the **CHANNEL** selector knob to select time offset from UTC. See illustration below to find your offset time from UTC. If “0:00” is assigned, the time is the same as UTC (Universal Time Coordinated or GMT Greenwich Mean Time).
5. Press the [**ENT**] key to store the time offset.
6. To exit this menu and return to radio operation mode press the [**16/9**] key.

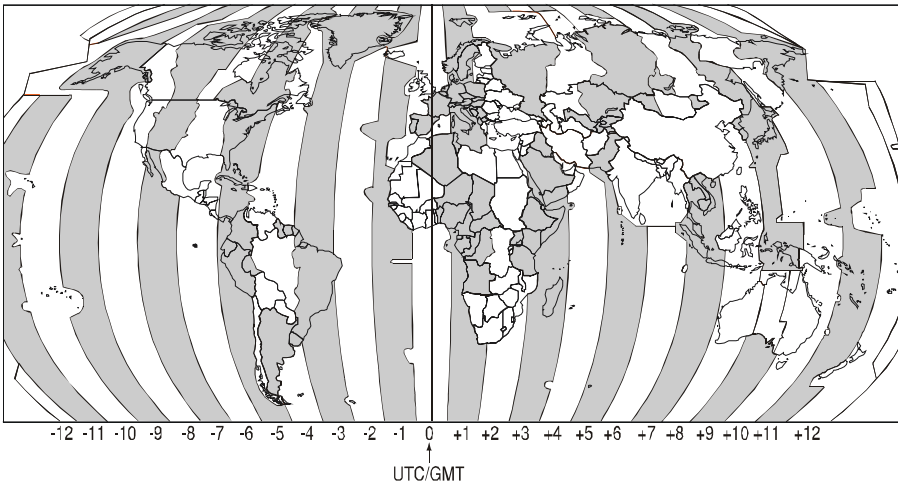

OFFSET TIME TABLE

12.4 TIME LOCATION

This selection selects the time display between local time and UTC (time GPS sends to radio). Time is displayed when GPS position (LAT/LON) is displayed by press and holding the [H/L(NAV)] key.

1. Press and hold down the [CALL(MENU)] key until “Radio Setup” menu appears.
2. Press the [ENT] key, then select “Time Disp.” in the “Radio Setup” menu with the CHANNEL selector knob.
3. Press the [ENT] key.
4. Turn the CHANNEL selector knob to select “UTC” or “Local.”
5. Press the [ENT] key to store the selected setting.
6. To exit this menu and return to radio operation mode press the [16/9] key.



In the local time mode, the display shows the time by the 12-hour system. Meanwhile, the display shows the time by the 24-hour system in the UTC mode.

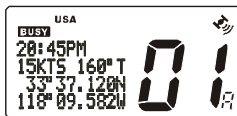

(“UTC” mode)

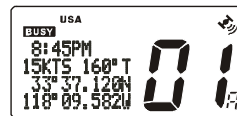

(“LOCAL” mode)

12.5 TRUE MAGNETIC CHANGE (NAV display)

This selection allows customizing the GPS COG (Course Over Ground) displayed on the LCD to be in True or Magnetic.

1. Press and hold down the [CALL(MENU)] key until “Radio Setup” menu appears.
2. Press the [ENT] key, then select “Magnetic” in the “Radio Setup” menu with the CHANNEL selector knob.
3. Press the [ENT] key.
4. Turn the CHANNEL selector knob to select “On” (representing “Magnetic”) or “Off” (representing “True”).
5. Press the [ENT] key to store the selected setting.
6. To exit this menu and return to radio operation mode press the [16/9] key.



12.6 PRIORITY CHANNEL SET

Allows selection of the priority channel when priority scan is enabled.

1. Press and hold down the [CALL(MENU)] key until “Radio Setup” menu appears.
2. Press the [ENT] key, then select “Priority CH” in the “Radio Setup” menu with the **CHANNEL** selector knob.
3. Press the [ENT] key.
4. Turn the **CHANNEL** selector knob to select the channel to be a priority.
5. Press the [ENT] key to store the selected setting.
6. To exit this menu and return to radio operation mode press the [16/9] key.

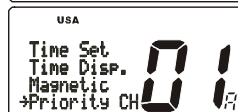

12.7 SCAN TYPE

This selection selects the scan mode between “Memory Scan” and “Priority Scan.”

1. Press and hold down the [CALL(MENU)] key until “Radio Setup” menu appears.
2. Press the [ENT] key, then select “SCAN Type” in the “Radio Setup” menu with the **CHANNEL** selector knob.
3. Press the [ENT] key.
4. Turn the **CHANNEL** selector knob to select “Priority” or “Memory.”
5. Press the [ENT] key to store the selected setting.
6. To exit this menu and return to radio operation mode press the [16/9] key.



12.8 SCAN RESUME TIME

This selection is used to select the time the **GX3000S** waits after a transmission ends before starting scanning.

1. Press and hold down the **[CALL(MENU)]** key until “Radio Setup” menu appears.
2. Press the **[ENT]** key, then select “SCAN Resume” in the “Radio Setup” menu with the **CHANNEL** selector knob.
3. Press the **[ENT]** key.
4. Turn the **CHANNEL** selector knob to select the desired resume time. The resume time can be set to “1sec,” “2sec,” “3sec,” or “Off.” In the “Off” selection, the scanner will resume after the other station stops transmitting (carrier drops).
5. Press the **[ENT]** key to store the selected setting.
6. To exit this menu and return to radio operation mode press the **[16/9]** key.

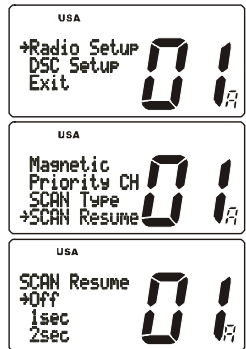

12.9 KEY BEEP (ON/OFF)

This selection allows the key beep to be turned off.

1. Press and hold down the **[CALL(MENU)]** key until “Radio Setup” menu appears.
2. Press the **[ENT]** key, then select “Key Beep” in the “Radio Setup” menu with the **CHANNEL** selector knob.
3. Press the **[ENT]** key.
4. Turn the **CHANNEL** selector knob to select “On” or “Off.”
5. Press the **[ENT]** key to set the key beep condition.
6. To exit this menu and return to radio operation mode press the **[16/9]** key.



NOTE

Emergency alarm and beeps for DSC operation cannot be turned OFF.

12.10 WX ALERT

This selection allows the radios NOAA Weather alert to be turned off. Default setting is ON.

1. Press and hold down the [CALL(MENU)] key until “Radio Setup” menu appears.
2. Press the [ENT] key, then select “WX Alert” in the “Radio Setup” menu with the **CHANNEL** selector knob.
3. Press the [ENT] key.
4. Turn the **CHANNEL** selector knob to select the desired WX alert mode. The WX alert mode can be set to “On SCAN,” “On WX,” “On SCAN/WX,” or “Off.”
5. Press the [ENT] key to store the selected setting.
6. To exit this menu and return to radio operation mode press the [16/9] key.

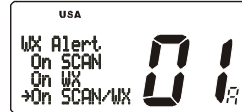
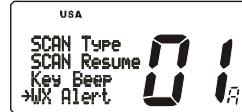

12.11 VOICE SCRAMBLER (REQUIRES OPTIONAL CVS2500)

This menu is used to setup the channels to be scrambled and the scrambler code.

NOTE

This menu will not appear unless a **CVS2500** is installed.

1. Press and hold down the [CALL(MENU)] key until “Radio Setup” menu appears.
2. Press the [ENT] key, then select “Scrambler” in the “Radio Setup” menu with the **CHANNEL** selector knob .
3. Press the [ENT] key.
4. Select the operating channel to be scrambled with the **CHANNEL** selector knob.
5. Press the [ENT] key to store the selected channel.
6. Turn the **CHANNEL** selector knob to change the scrambler code. The scrambler code can be set from “0” to “3” and “OFF.” When “OFF” is selected the voice scrambler is disabled.
7. Press the [SCAN] key to store the scrambler code.
8. Repeat steps 4 and 7 to set other channels.
9. To exit this menu and return to radio operation mode press the [16/9] key.

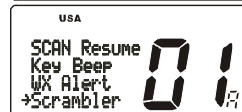

Note: Voice Scrambler may not be activated on Channel 16 and 70.

12.12 CHANNEL NAME CHANGE

This selection allows you to customize the name of a channel from the default name.

1. Press and hold down the **[CALL(MENU)]** key until “Radio Setup” menu appears.
2. Press the **[ENT]** key, then select “CH Name” in the “Radio Setup” menu with the **CHANNEL** selector knob.
3. Press the **[ENT]** key.
4. Turn the **CHANNEL** selector knob to select the channel to be named, then press the **[ENT]** key.
5. Turn the **CHANNEL** selector knob to scroll through the first letter of the channel name.
6. Press the **[ENT]** key to store the first letter in the name and step to the next letter to the right.
7. Repeat step 6 and 7 until the name is complete. The name can consist of up to twelve characters, if you do not use all twelve characters press the **[ENT]** key to move to the next space. This method can also be used to enter a blank space in the name. To clear the previous letter, press the **[CLR]** key.
8. Press and hold the **[ENT]** key to save the name.
9. If you want to enter the name of another channel, select “Next” then press the **[ENT]** key. Otherwise, select “Exit” then press the **[ENT]** key.
10. To exit this menu and return to radio operation mode press the **[16/9]** key.



12.13 NAMING THE RADIO OR SECOND STATION MIC OR HANDSET

This function allows you to change the name of the RADIO or second station microphones. Example: "RADIO - CABIN," "RAM1 - HELM," "RAM2 - FLYBRIDGE."

1. Press and hold down the [CALL(MENU)] key until "Radio Setup" menu appears.
2. Press the [ENT] key, then select "Unit Name" in the "Radio Setup" menu with the CHANNEL selector knob.
3. Press the [ENT] key.
4. Turn the CHANNEL selector knob to select the Unit ("Radio," "Ram1," or "Ram2") to be named, then press the [ENT] key.
5. Turn the CHANNEL selector knob to scroll through the first letter of the channel name.
6. Press the [ENT] key to store the first letter in the name and step to the next letter to the right.
7. Repeat step 6 and 7 until the name is complete. The name can consist of up to twelve characters, if you do not use all twelve characters press the [ENT] key to move to the next space. This method can also be used to enter a blank space in the name. To clear the previous letter, press the [CLR] key.
8. Press and hold the [ENT] key to enter the name and return to the "Unit Name" menu.
9. If you want to enter the name of another unit, repeat steps 4 through 8.
10. To exit this menu and return to radio operation mode press the [16/9] key.

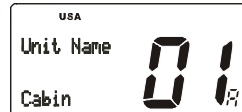
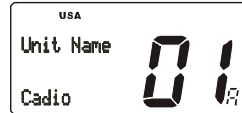
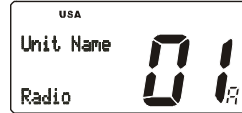
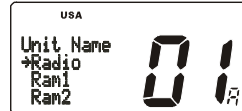
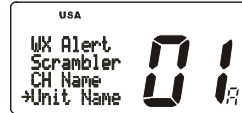

12.14 FOG ALERT TONE FREQUENCY

This selection allows you to select the Alert Tone Frequency for the PA/FOG Operation. Available selections are “200 Hz” through “850 Hz” in 50 Hz steps. The default Alert Tone Frequency is 400 Hz.

1. Press and hold down the **[CALL(MENU)]** key until “Radio Setup” menu appears.
2. Press the **[ENT]** key, then select “FOG Freq.” in the “Radio Setup” menu with the **CHANNEL** selector knob.
3. Press the **[ENT]** key.
4. Turn the **CHANNEL** selector knob to select desired tone frequency.
5. Press the **[ENT]** key to store the selected setting.
6. To exit this menu and return to radio operation mode press the **[16/9]** key.

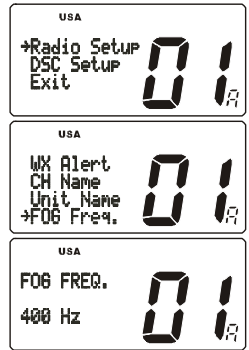

12.15 RECEIVER AUDIO TONE CONTROL

Allows the treble and bass of the speaker audio to be adjusted for best listening in noisy environments. The effect is similar to adjusting a the treble and bass controls on a stereo.

1. Press and hold down the **[CALL(MENU)]** key until “Radio Setup” menu appears.
2. Press the **[ENT]** key, then select “TONE CONT.” in the “Radio Setup” menu with the **CHANNEL** selector knob.
3. Press the **[ENT]** key, then select “BASS” with the **CHANNEL** selector knob.
4. Turn the **CHANNEL** selector knob to select desired audio response in the lower frequency range. Available selections are “-6” through “+6.”
5. Press the **[ENT]** key to store the selected setting.
6. Select “TREBLE” with the **CHANNEL** selector knob.
7. Turn the **CHANNEL** selector knob to select desired audio response in the highr frequency range. Available selections are “-6” through “+6.”
8. Press the **[ENT]** key to store the selected setting.
9. To exit this menu and return to radio operation mode press the **[16/9]** key.

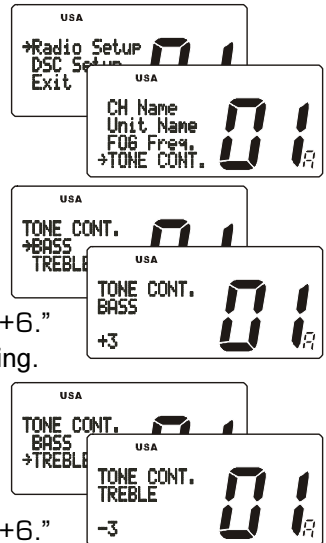

13 ENHANCED RAM+ MIC OPERATION

When the RAM+ microphone is connected to the **GX3000S**, most VHF, DSC, and setup menus can be remotely operated. The RAM+ Mic is supplied with 23 feet (7 m) of routing cable and can be extended up to 70 feet (21 m) using three 23 feet extension cables model **CT-100**. The intercom operation can be used between the RAM+ Mic and the transceiver.

13.1 RAM+ MIC CONTROLS

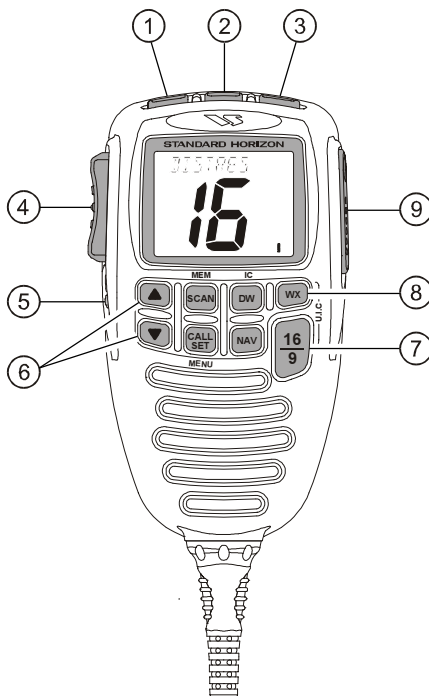

① SQUELCH CONTROL (SQL)

Activates the squelch adjusting mode.

Press this key to activate the squelch adjusting mode. Press the microphone's [▲] or [▼] key to adjust the squelch.

When this key is pressed and held down for 1 second or more, the squelch is turned off.

② VOLUME KEY (VOL)

Activates the volume adjusting mode.

Press this key to activate the volume adjusting mode. Press the microphone's [▲] or [▼] to adjust the volume.

③ **POWER SWITCH (PWR)**

Press and hold down this key to turn to the transceiver and RAM+ Mic on and off.

④ **PTT (Push-To-Talk) SWITCH**

Activates transmission.

⑤ **[H/L] KEY**

Toggles between high and low power. When the [H/L] key is pressed while the transceiver is on channel 13 or 67, the power will temporarily switch from LO to HI power until the **PTT** is released. The [H/L] key does not function on transmit inhibited and low power only channels.

⑥ **[▲](UP)/[▼](DOWN) KEY**

These keys are used to select channels, adjust the volume and squelch level, and to choose the item selection of different functions (such as the DSC operation). In many ways, these keys emulate the function of the transceiver's **CHANNEL** selector knob.

⑦ **[16/9] KEY**

Immediately recalls channel 16 from any channel location. Holding down this key recalls channel 9. Pressing the [16/9] key reverts to the previous selected working channel.

Secondary use

Please see secondary use for the [WX] and [MEM] key.

⑧ **KEY PAD**

[SCAN] Key

1. Starts and stops scanning of programmed channels.
2. If held while the [UP(▲)] or [DOWN(▼)] key on the microphone are pressed, the radio will show the channels programmed in scan memory. This function will not work if the unit is scanning.

NOTE: The priority channel by default is Channel 16, however the priority channel can be changed. To select a different priority channel refer to section “**12.6 PRIORITY CHANNEL SET.**”

[CALL/SET] Key

The [CALL/SET] key functions as the enter key.

Secondary use

Press the [CALL/SET] key to access the DSC OPERATION menu.

Press and hold the [CALL/SET] key to access the SETUP menu.

[DW] Key

Watches for a transmission on CH16 and another selected channel until either signal is received. (Dual watch)

Secondary use

Press and hold [DW] key, intercom operation will operate between radio and RAM+ Mic.

[NAV] Key

Press this key, when connected to the GPS receiver, the LCD displays Position Data and Time from the GPS.

[WX] Key

Immediately recalls the previously selected US NOAA weather channel from any channel location.

Secondary use

Holding down the [16/9] key while pressing the [WX] key switch the Channel Group.

NOTE: If position is displayed, this icon will be hidden.

⑨ [DISTRESS] KEY

Used to send a DSC Distress Call. To send the distress call refer to section "11.3.1. Transmitting a DSC Distress Call."

13.2 PA/FOG OPERATION

The RAM+ is capable of controlling the 30W Public address, 4 fog horns, bells and whistles.

13.2.1 Operating the PA / Hailer

1. Press and hold the [NAV] key then select "PUBLIC ADDRESS" with the [▲] or [▼] key.
2. Press the [CALL/SET] key.
3. Press the PTT switch and speak into the microphone.
4. To turn up the PA Volume, press the PTT switch and press the [▲] or [▼] keys to adjust the Audio output level. The level can be set from 0 to 30W.
5. To adjust the listen back volume, (while in listenback mode) press the [VOL] Key, then press the [▲] or [▼] key to the desired listen back volume.



To exit from the PA / Hailer mode, press and hold down the [NAV] key again.

13.2.2 Operating the FOG Horn

The **GX3000S** is capable of sending Underway, Stop, Sail, Tow, Horn, Siren, Aground and Anchor signals.

1. Press and hold the **[NAV]** key then select “FOG” with the **[▲]** or **[▼]** key.
2. Press the **[CALL/SET]** key.
3. Select the one of the eight functions described above with the **[▲]** or **[▼]** key and press the **[CALL/SET]** key.
4. On the “Horn” and “Siren” modes, press the **PTT** switch to activate the tone through the HAIL/PA speaker. Press the **[▲]** or **[▼]** keys to adjust the Audio output level. The level can be set from 0 to 30W.
5. To adjust the listen back volume, (while in listenback mode) press the **[VOL]** Key, then press the **[▲]** or **[▼]** key to the desired listen back volume.

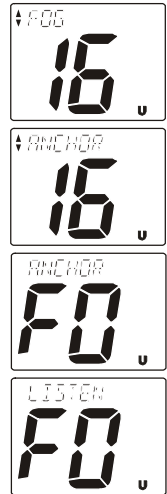

To exit from the FOG HORN mode, press and hold down the **[NAV]** key again.

13.3 INTERCOM OPERATION

13.3.1 Communication

1. Press and hold the **[DW]** key while in the “RADIO” mode, the mode is changed to “INTERCOM” mode. When the “INTERCOM” operation is activated, “IC” is displayed on the RAM+ Mic (and **VH-310** Handset) and “INTERCOM” is displayed on the **GX3000S**.



2. Press the **PTT** switch, “TALK” is displayed.

NOTE: A warning beep is emitted when the RAM+ Mic **PTT** switch is pressed while the transceiver microphone’s **PTT** switch is pressed.



(RAM+ Mic’s PTT switch is pressed)

3. Speak slowly and clearly into the microphone, hold the microphone about 1/2 inch away from your mouth.
4. When finished, release the **PTT** switch.
5. Press the **[DW]** key momentarily the mode will revert to “RADIO” mode.



(GX3000S’s PTT switch is pressed)

13.3.2 Calling

Hold down the **[DW]** key for 1 second or more, when the “INTERCOM” operation is activated. A calling beep is emitted twice from the transceiver speaker.

13.4 DSC/RADIO SETUP MODE

The RAM+ can access the DSC / RADIO setup menu (refer to section “11 DIGITAL SELECTIVE CALLING” and section “12 RADIO SETUP MODE” for details). The LAMP, CONTRAST, and KEY BEEP menu item accessed from the RAM+ only controls the RAM+’s display and speaker.

DSC/RADIO Setup mode from the RAM+:

1. Press and hold down the [CALL/SET] key until “RADIO SETUP” menu appears.
2. Press the [▲]/[▼] key to select “RADIO SETUP” or “DSC SETUP” menu.
3. Press the [CALL/SET] key, then select the menu item you wish to work on by pressing the [▲]/[▼] key.
4. Press the [CALL/SET] key.
5. Press the [▲]/[▼] key to change the value or condition for the menu item, then press the [CALL/SET] key to save the new setting.
6. Press the [▲]/[▼] key to select “EXIT,” then press the [CALL/SET] key to return to the normal operation.

RADIO SETUP-menu

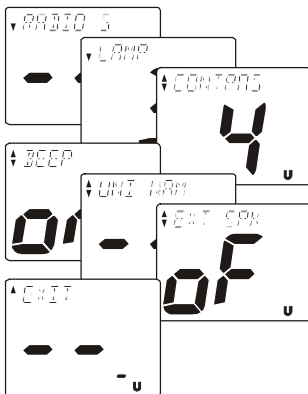

DSC SETUP-menu

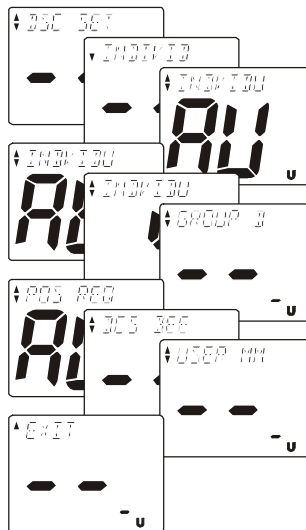

NOTE

When setup menu is selected, the **GX3000S** will be temporarily disabled until the RAM+ mic, exits from the setup mode.

14 VH-310 HANDSET OPERATION

When the **VH-310** HANDSET is connected to the **GX3000S**, most VHF, DSC, and setup menus can be remotely operated. The **VH-310** HANDSET is supplied with 23 feet (7 m) of routing cable and can be extended up to 70 feet (21 m) using three 23 feet extension cables model **CT-100**. The intercom operation can be used between the **VH-310** HANDSET or the **GX3000S**.

14.1 VH-310 HANDSET CONTROLS

① **PWR** key

Press and hold down this key to turn to the transceiver and **VH-310** HANDSET on and off.

② **PTT (Push-To-Talk)** Switch

Activates transmission.

③ **[H/L]** key

Toggles between high and low power. When the **[H/L]** key is pressed while the transceiver is on channel 13 or 67, the power will temporarily switch from “LO” to “HI” power until the **PTT** is released. The **[H/L]** key does not function on transmit inhibited and low power only channels.

④ **[DISTRESS]** key

Used to send a DSC Distress Call. To send the distress call refer to section “**11.3.1. Transmitting a DSC Distress Call.**”

⑤ **RADIO CONTROL KEYS**

[VOL] key

Activates the volume adjusting mode.

Press this key to activate the volume adjusting mode.

Press the **[▲]** or **[▼]** to adjust the volume.

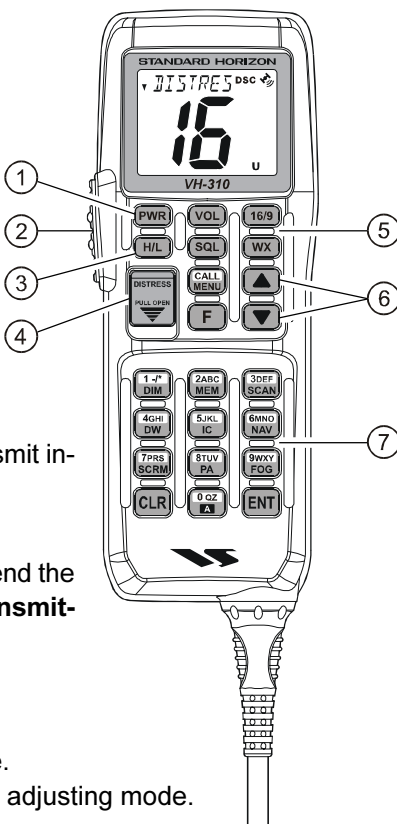

NOTE

When the **VH-310** handset is removed from the cradle the speaker audio will be automatically reduced so not to damage your hearing. When the **VH-310** is in the cradle the speaker audio will increase so communications can be heard.

[SQL] key

Activates the squelch adjusting mode.

Press this key to activate the squelch adjusting mode. Press the [▲] or [▼] key to adjust the squelch.

[CALL(MENU)] key

The [CALL(MENU)] key functions as the enter key.

Secondary use

Press the [CALL(MENU)] key to access the DSC OPERATION menu. The "INDIVIDUAL CALL," "GROUP CALL," "ALL SHIP CALL," "POSITION REQUEST," "POSITION SEND," "STANDBY MODE," and "CALL WAITING" functions can be accessed from the DSC OPERATION menu. Press and hold the [CALL(MENU)] key to access the RADIO SETUP (refer to section 12) or DSC SETUP menu (refer to section 11).

[F] key

Activates the "Alternate" key function.

Press this key to activates the "Alternate" key function of the ten keypad.

[16/9] key

Immediately recalls channel 16 from any channel location. Holding down this key recalls channel 9. Pressing the [16/9] key reverts to the previous selected working channel.

Secondary use

Press and hold the [16/9] key then press the [WX] key to switch the USA, International or Canadian channels.

[WX] key

Immediately recalls the previously selected US NOAA weather channel from any channel location.

Secondary use

Holding down the [16/9] key while pressing the [WX] key switches the Channel Group.

⑥ [▲] / [▼] KEY

These keys are used to select channels, adjust the volume and squelch level, and to choose the item selection of different functions (such as DSC operation).

⑦ KEYPAD

[1(DIM)] key

When in radio mode, this key is used to directly select channel digit “1” in a channel number.

Secondary use

Press the [F] key first then press the [1(DIM)] key to access the LCD Dimmer menu. Refer to section “**12.1 LAMP ADJUSTING**” for details.

[2(MEM)] Key

When in radio mode, this key is used to directly select channel digit “2” in a channel number.

Secondary use

Press the [F] key first then press the [2(MEM)] key, memorize the selected channel into the transceiver scan memory for scanning. When repeat the same procedures ([F] → [2(MEM)]), will delete the channel from the scan memory. Refer to section “**10.12 SCANNING**” for details.

[3(SCAN)] Key

When in radio mode, this key is used to directly select channel digit “3” in a channel number.

Secondary use

Press the [F] key first then press the [3(SCAN)] key to start and stop the scanning of programmed channels. Refer to section “**10.12 SCANNING**” for details.

[4(DW)] Key

When in radio mode, this key is used to directly select channel digit “4” in a channel number.

Secondary use

Press the [F] key first then press the [4(DW)] key to scan for voice communications on the priority channel and another selected channel until a signal is received on either channel (Dual Watch). Refer to section “**10.11 DUAL WATCH (TO PRIORITY CHANNEL)**” for details.

[5(IC)] Key

When in radio mode, this key is used to directly select channel digit “5” in a channel number.

Secondary use

Press the [F] key then press the [5(IC)] key to activate intercom function between RAM+(s) or **VH-310** handset(s).

Refer to section “**14.3 INTERCOM OPERATION**” for details.

[6(NAV)] Key

When in radio mode, this key is used to directly select channel digit “6” in a channel number.

Secondary use

Press the [F] key first then press the [6(NAV)] key, the LCD will display NAV GPS Data, Time, SOG (Speed Over Ground), and COG (Course Over Ground) when a GPS is connected to the accessory cable of the **GX3000S**. See section “8.3 ACCESSORY CABLE” for details.

[7(SCRM)] Key

When in radio mode, this key is used to directly select channel digit “7” in a channel number.

[8(PA)] Key

When in radio mode, this key is used to directly select channel digit “8” in a channel number.

[9(FOG)] Key

When in radio mode, this key is used to directly select channel digit “9” in a channel number.

[0] Key

When in radio mode, this key is used to directly select channel digit “0” in a channel number.

Secondary use

Used to select A (alpha channels). Press the desired channel keys then press and hold [0] key until “A” appears next to the channel number and press [ENT] to select the channel.

[CLR] Key

Press the [CLR] key to cancel the menu selection and/or keypad entry.

[ENT] Key

Press the [ENT] key to enter the menu selection and/or keypad entry.

14.2 PA/FOG OPERATION

The **VH-310** Handset is capable of controlling the 30W Public address, 4 fog horns, bells and whistles.

14.2.1 Operating the PA / Hailer

1. Press the [F] key followed by the [8(PA)] key, activate the "PA / HAIL" mode.
2. Press the **PTT** switch and speak into the microphone.
3. To turn up the PA Volume, press the **PTT** switch and press the [▲] or [▼] keys to adjust the Audio output level. The level can be set from 0 to 30W.
4. To adjust the listen back volume, (while in listenback mode) press the [VOL] Key, then press the [▲] or [▼] key to the desired listen back volume.



To exit from the PA / Hailer mode, press the [F] key followed by the [8(PA)] key again.

14.2.2 Operating the FOG Horn

The **GX3000S** is capable of sending Underway, Stop, Sail, Tow, Horn, Siren, Aground and Anchor signals.

1. Press the [F] key followed by the [9(FOG)] key, activate the "FOG HORN" menu.
2. Select the one of the eight functions described above with the [▲] or [▼] key and press the [ENT] key.
3. On the "Horn" and "Siren" modes, press the **PTT** switch to activate the tone through the HAIL/PA speaker. Press the [▲] or [▼] keys to adjust the Audio output level. The level can be set from 0 to 30W.
4. To adjust the listen back volume, (while in listenback mode) press the [VOL] Key, then press the [▲] or [▼] key to the desired listen back volume.



To exit from the FOG HORN mode, press the [F] key followed by the [9(FOG)] key again.

14.3 INTERCOM OPERATION

14.3.1 Communication

1. Press the [F] key followed by the [5(IC)] key, the mode is changed to “INTERCOM” mode.
2. When the “INTERCOM” operation is activated, “IC” is displayed on the **VH-310** Handset (and RAM+ Mic, if used) and “INTERCOM” is displayed on the **GX3000S**.
3. Press the **PTT** switch, “TALK” is displayed.



NOTE: A warning beep is emitted when the RAM+ Mic **PTT** switch is pressed while the transceiver microphone's **PTT** switch is pressed.

4. Speak slowly and clearly into the microphone, hold the microphone about 1/2 inch away from your mouth.
5. When finished, release the **PTT** switch.
6. To exit the “INTERCOM” mode and return to radio operation mode, press the [F] key followed by the [5(IC)] key again.



(VH-310's PTT switch is pressed)

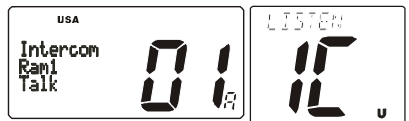

(GX3000S's PTT switch is pressed)

14.3.2 Calling

Press and hold the [5(IC)] key for 1 second when the “INTERCOM” operation is activated, a calling beep is emitted from the **GX3000S** speaker.

14.4 MANUAL INPUTTING OF THE GPS LOCATION (LAT/LON)

You may send the Latitude/Longitude of your vessel manually from the **VH-310** Handset even if the **GX3000S** is not connected the GPS receiver unit.

After the position is entered, transmitting a DSC Distress, Position Request, or Position Send will contain the manually entered position.

1. Press and hold down the [**CALL(MENU)**] key until "Radio Setup" menu appears.
2. Press the [**▼**] key to select "DSC SETUP" menu.
3. Press the [**ENT**] key, then select "POS INPUT" with the [**▲**]/ [**▼**] key.
4. Press the [**ENT**] key then, enter the your local time from the keypad by the 24-hour system on the UTC time.
5. Enter the Latitude of your vessel location (xx.xx.xx) by the keypad, then press the [**6(NAV)**] key to select North (N), or [**7(SCRM)**] key to select South (S).
6. Enter the Longitude of your vessel location (xxx.xx.xx) by the keypad, then press the [**3(SCAN)**] to select East (E), or [**9(FOG)**] key to select West (W).
7. If a number was entered by mistake, press the **H/L** key repeatedly to select the number. Press the [**▲**]/ [**▼**] key to select the desired number.
8. Press and hold in the [**ENT**] key to store the data entered, then press the [**16/9**] key to exit this menu and return to radio operation mode.

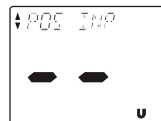
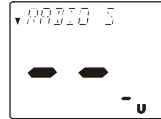

14.5 DSC/RADIO SETUP MODE

The **VH-310** Handset can access the DSC / RADIO setup menu (refer to section “**11 DIGITAL SELECTIVE CALLING**” and section “**12 RADIO SETUP MODE**” for details). The CONTRAST, NAV DISPLAY, KEY BEEP, and AF SELECT menu item accessed from the **VH-310** Handset only controls the **VH-310** Handset’s display and speaker.

DSC/RADIO Setup mode from the **VH-310** Handset:

1. Press and hold down the **[CALL(MENU)]** key until “RADIO SETUP” menu appears.
2. Press the **[▲]/[▼]** key to select “RADIO SETUP” or “DSC SETUP” menu.
3. Press the **[ENT]** key, then select the menu item you wish to work on by pressing the **[▲]/[▼]** key.
4. Press the **[ENT]** key.
5. Press the **[▲]/[▼]** key to change the value or condition for the menu item, then press the **[ENT]** key to save the new setting.
6. Press the **[▲]/[▼]** key to select “EXIT,” then press the **[ENT]** key to return to the normal operation.

RADIO SETUP-menu

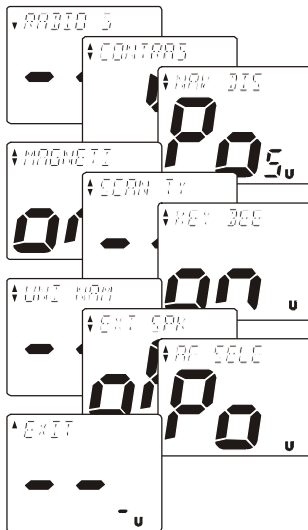

DSC SETUP-menu

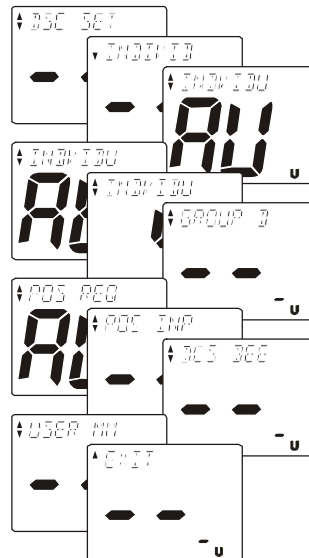

NOTE

When the SETUP menu is selected, using the **VH-310** Handset, the **GX3000S** will be temporarily disabled until the **VH-310** Handset exits from the setup mode.

14.5.1 Changing GPS Information to Vessel position or COG

Allows customizing the NAV data showing GPS Information. Factory default is “Your Vessel’s Current Position,” however, following the steps below the GPS Information can be changed to “Course Over Ground (COG).”

1. Press and hold down the [CALL(MENU)] key until “RADIO SETUP” menu appears.
2. Press the [ENT] key, then select “NAV DISPLAY” with the [▲]/[▼] key.
3. Press the [CALL(SET)MENU] key.
4. Press the [▼] or [▲] key to select “Pos (Your Vessel’s Current Position)” or “Cru (Course Over Ground).”
5. Press the [ENT] key to store the data entered, then press the [16/9] key to exit this menu and return to radio operation mode.

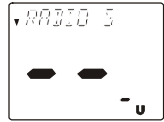

14.5.2 External Speaker AF Selection

The AF SELECT menu allows you to set the audio output level of the VH-310’s External Speaker to “fixed” regardless the VOL level setting of the VH-310, which is useful to the case when use with the amplified speaker, such as the Standard Horizon MLS-310.

1. Press and hold down the [CALL(MENU)] key until “Radio Setup” menu appears.
2. Press the [ENT] key, then select “AF SELECT” with the [▲]/[▼] key.
3. Press the [ENT] key.
4. Press the [▲] or [▼] key to select “Pr” (External Speaker Level is “Fixed”) or “Po” (External Speaker Level is “Adjustable”).
5. Press the [ENT] key to store the data entered, then press the [16/9] key to exit this menu and return to radio operation mode.

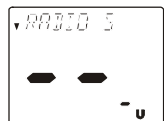

15 MAINTENANCE

The inherent quality of the solid-state components used in this transceiver will provide many years of continuous use. Taking the following precautions will prevent damage to the transceiver.

- Keep the microphone connected or the jack covered at all times to prevent corrosion of electrical contacts;
- Never key the microphone unless an antenna or suitable dummy load is connected to the transceiver.
- Ensure that the supply voltage to the transceiver does not exceed 16 VDC or fall below 11 VDC.
- Use only STANDARD HORIZON-approved accessories and replacement parts.

In the unlikely event of serious problems, please contact your Dealer or our repair facility. Address and phone numbers for this facility, as well as warranty information, are contained in section “**17 WARRANTY.**”

15.1 REPLACEMENT PARTS

Occasionally an owner needs a replacement mounting bracket or knob. These can be ordered from our Parts Department by writing or calling:

Marine Division of Vertex Standard

US Headquarters

10900 Walker Street, Cypress, CA 90630, U.S.A.

Telephone (714) 827-7600

Commonly requested parts, and their part numbers are listed below.

- **Panel Cover:** RA0772200
- **Power Cord:** T9023306
- **VOL/SQL Knob (Black):** RA0771400
- **VOL/SQL Knob (White):** RA0771300
- **Rotary Channel Knob (Black):** RA0771600
- **Rotary Channel Knob (White):** RA0771500
- **Mounting Bracket (Black):** RA0773200
- **Mounting Bracket (White):** RA0773100
- **Mounting Bracket Knob (Black):** RA045910A
- **Mounting Bracket Knob (White):** RA043770A
- **Microphone Hanger (Black):** RA0458800
- **Microphone Hanger (White):** RA0436000
- **CMP25 RAM+ Mic or VH-310 Routing Cable Assembly:** S8101512

15.2 FACTORY SERVICE

In the unlikely event that the radio fails to perform or needs servicing, please contact the following:

Standard Horizon

Attention Marine Repair Department

10900 Walker Street, Cypress, CA 90630

Telephone (800) 366-4566

An "RA" Return Authorization number is not necessary to send a product in for service. Include a brief note describing the problem along with your name, return address, phone number, and proof of purchase.



15.3 TROUBLESHOOTING CHART

| SYMPTOM | PROBABLE CAUSE | REMEDY |
|---|--|---|
| Transceiver fails to power up. | No DC voltage to the transceiver, or blown fuse. | a. Check the 12VDC battery connections and the fuse. b. The PWR key needs to be pressed and held to turn the radio on. |
| Transceiver blows fuse when connected to power supply. | Reversed power wires. | Check the power cable for DC voltage, or replace the fuse (6A 250V). Make sure the red wire is connected to the positive (+) battery post, and the black wire is connected to the negative (-) battery post. If the fuse still blows, contact your Dealer. |
| Popping or whining noise from the speaker while engine runs. | Engine noise. | Reroute the DC power cables away from the engine. Add noise suppressor on power cable. Change to resistive spark plug wires and/or add an alternator whine filter. |
| Sound is not emitted from the internal or external speaker. | Accessory cable. | Check the connections of the accessory cable (Possible short circuit on the External speaker cable WHITE/SHIELD). |
| Receiving station report low transmit power, even with transceiver set to HI power. | Antenna. | Have the antenna checked or test the transceiver with another antenna. If the problem persists, contact your Dealer for servicing. |
| "HI BATTERY" or "LO BATTERY" message is appeared when the power is turned on. | The power supply voltage is too high or too low. | Confirm that the connected power supply voltage is not 17 volts or lower than 10 volts. Confirm that the generator has not malfunctioned. |
| Your position is not displayed. | Accessory cable. | Check the accessory cable connection. Some GPS use the battery ground line for NMEA connection. |
| | Setting of the GPS navigation receiver. | Check the output signal format of the GPS navigation receiver. This radio requires NMEA0183 format with GLL, RMB, GGA, or GNS sentence as an output signal. If the GPS has a baud rate setting make sure to select 4800 and parity to NONE. |

16 CHANNEL ASSIGNMENTS

Tables on the following columns list the VHF Marine Channel assignments for U.S.A. and International use. Below are listed some data about the charts.

1. VTS. Where indicated, these channels are part of the U.S. Coast Guard's **Vessel Traffic System**.
2. Alpha channel numbers, that is, channel numbers followed by the letter A (such as Channel 07**A**) are **simplex** channels on the U.S.A. or Canadian channel assignments whose counterparts in the International assignments are **duplex** channels. International channels do not use "alpha" numbers. If you call the Coast Guard on Channel 16, they will sometimes ask you to "**go to channel 22 Alpha**." This is a channel assigned to U.S.A, and Canadian Coast Guards for handling distress and other calls. If your radio is set for **International** operation you will go to Channel 22 instead of 22**A**, and will not be able to communicate with the Coast Guard. To use Channel 22**A**, your radio must be set for **USA** or **Canada** operation, usually by a U/I/C (USA/International/Canada) control or combination of controls. Channel 22 (without an "A") is an **International** duplex channel for port operations. Some radios indicate an "A" adjacent to the alpha channels on the display; on others "alpha" is not indicated but the proper channel is selected based on the U/I/C setting.
3. Bridge-to-Bridge channels (for example, Channel 13) are for use by bridge operators on intercoastal waterways and rivers. It is also used by marine vessels in the vicinity of these bridges for navigation and for communicating with the bridge operators. Note that a limit of 1 Watt is specified for these channels. See page 28 for additional information.
4. The **S/D** column on the chart indicates either S (simplex) or D (duplex). **Simplex** means transmitting and receiving on the same frequency. Only one party at a time can talk, unlike a telephone. Be sure to say "**over**" and release your microphone push-to-talk switch at the end of each transmission. **Duplex** operation involves the use of one frequency for transmitting and a separate frequency for receiving. On channels specified as duplex on the charts, correct mode of operation is established automatically by your radio when you select a channel; you cannot change the mode. And you still must release the push-to-talk switch after each transmission in order to listen to the radio.
5. Channels normally used by recreational boaters are those that include the term "non-commercial" in the **Channel Use** column of the chart. Some of these are shared with other users and some are used only in certain geographic regions.



6. Marine vessels equipped with VHF radios are required to monitor Channel 16.

| VHF MARINE CHANNEL CHART | | | | | | | | |
|--------------------------|----------|----------|---|----------|----------------|---------|--|--|
| CH | U | C | I | S/D | TX | RX | CHANNEL USE | |
| 01 | | X | X | D | 156.050 | 160.650 | Public Correspondence (Marine Operator) | |
| 01A | X | | | S | 156.050 | | Port Operation and Commercial. VTS in selected areas | |
| 02 | | X | X | D | 156.100 | 160.700 | Public Correspondence (Marine Operator) | |
| 03 | | X | X | D | 156.150 | 160.750 | Public Correspondence (Marine Operator) | |
| 03A | X | | | S | 156.150 | | US Government only, Coast Guard | |
| 04 | | | X | D | 156.200 | 160.800 | Public Correspondence (Marine Operator), Port operation, ship movement | |
| 04A | | X | | S | 156.200 | | Pacific coast: Coast Guard, East Coast: Commercial fishing | |
| 05 | | | X | D | 156.250 | 160.850 | Public Correspondence (Marine Operator), Port operation, ship movement | |
| 05A | X | X | | S | 156.250 | | Port operation. VTS in Seattle | |
| 06 | X | X | X | S | 156.300 | | Inter-ship Safety | |
| 07 | | | X | D | 156.350 | 160.950 | Public Correspondence (Marine Operator), Port operation, ship movement | |
| 07A | X | X | | S | 156.350 | | Commercial | |
| 08 | X | X | X | S | 156.400 | | Commercial (Inter-ship only) | |
| 09 | X | X | X | S | 156.450 | | Boater Calling channel, Commercial & Non-commercial (Recreational) | |
| 10 | X | X | X | S | 156.500 | | Commercial | |
| 11 | X | X | X | S | 156.550 | | Commercial. VTS in selected areas. | |
| 12 | X | X | X | S | 156.600 | | Port operation. VTS in selected areas. | |
| 13 | X | X | X | S | 156.650 | | Inter-ship Navigation Safety (Bridge-to-bridge) | |
| 14 | X | X | X | S | 156.700 | | Port operation. VTS in selected areas. | |
| 15 | X | | | S | - - - | 156.750 | Environmental (Receive only) | |
| 15 | | X | X | S | 156.750 | | Commercial, non-commercial, ship movement (1 W) | |
| 16 | X | X | X | S | 156.800 | | International Distress, Safety and Calling | |
| 17 | X | X | X | S | 156.850 | | State Controlled (1 W) | |
| 18 | | | X | D | 156.900 | 161.500 | Port operation, ship movement | |
| 18A | X | X | | S | 156.900 | | Commercial | |
| 19 | | | X | D | 156.950 | 161.550 | Port operation, ship movement | |
| 19A | X | | | S | 156.950 | | US: Commercial | |
| 19A | | X | | S | 156.950 | | Coast Guard | |
| 20 | X | X | X | D | 157.000 | 161.600 | Canadian Coast Guard Only, International: port operations and shipment | |
| 20A | X | | | S | 157.000 | | Port operation | |
| 21 | | | X | D | 157.050 | 161.650 | Port operation, ship movement | |
| 21A | X | X | | S | 157.050 | | U.S. Government Only, Canadian Coast Guard | |
| 22 | | | X | D | 157.100 | 161.700 | Port operation, ship movement | |
| 22A | X | X | | S | 157.100 | | US and Canadian Coast Guard Liaison and Maritime Safety Information Broadcasts announced on channel 16 | |



| VHF MARINE CHANNEL CHART | | | | | | | |
|--------------------------|----------|----------|---|----------|----------------|---------|--|
| CH | U | C | I | S/D | TX | RX | CHANNEL USE |
| 23 | | X | X | D | 157.150 | 161.750 | Public Correspondence (Marine Operator) |
| 23A | X | | | S | 157.150 | | U.S. Government Only |
| 24 | X | X | X | D | 157.200 | 161.800 | Public Correspondence (Marine Operator) |
| 25 | X | X | X | D | 157.250 | 161.850 | Public Correspondence (Marine Operator) |
| 26 | X | X | X | D | 157.300 | 161.900 | Public Correspondence (Marine Operator) |
| 27 | X | X | X | D | 157.350 | 161.950 | Public Correspondence (Marine Operator) |
| 28 | X | X | X | D | 157.400 | 162.000 | Public Correspondence (Marine Operator) |
| 60 | | X | X | D | 156.025 | 160.625 | Public Correspondence (Marine Operator) |
| 61 | | | X | D | 156.075 | 160.675 | Public Correspondence (Marine Operator), Port operation, ship movement |
| 61A | X | X | | S | 156.075 | | U.S. Government Only, Canadian Coast Guard-Pacific Coast, Commercial Fishing-East Coast |
| 62 | | | X | D | 156.125 | 160.725 | Public Correspondence (Marine Operator), Port operation, ship movement |
| 62A | | X | | S | 156.125 | | Public Coast: Coast Guard; East Coast: commercial fishing only |
| 63 | | | X | D | 156.175 | 160.775 | Public Correspondence (Marine Operator), Port operation, ship movement |
| 63A | X | | | S | 156.175 | | Port Operation and Commercial. VTS in selected areas. |
| 64 | | X | X | D | 156.225 | 160.825 | Public Correspondence (Marine Operator), Port operation, ship movement |
| 64A | X | X | | S | 156.225 | | U.S. Government Only, Canadian Commercial Fishing |
| 65 | | | X | D | 156.275 | 160.875 | Public Correspondence (Marine Operator), Port operation, ship movement |
| 65A | X | X | | S | 156.275 | | Port Operations |
| 66 | | | X | D | 156.325 | 160.925 | Public Correspondence (Marine Operator), Port operation, ship movement |
| 66A | X | X | | S | 156.325 | | Port Operations |
| 67 | X | X | X | S | 156.375 | | US: Commercial. Used for Bridge-to-bridge communications in lower Mississippi River. Inter-ship only, Canada: Commercial fishing, S&R |
| 68 | X | X | X | S | 156.425 | | Non-commercial (Recreational) |
| 69 | X | X | X | S | 156.475 | | US: Non-commercial (Recreational), Canada: Commercial fishing only, International: Inter-ship, Port operations and Ship movement |
| 70 | X | X | X | S | 156.525 | | Digital selective calling (voice communications not allowed) |
| 71 | X | X | X | S | 156.575 | | US, Canada: Non-commercial (Recreational), International: Port operations and Ship movement |
| 72 | X | X | X | S | 156.625 | | Non-commercial (Inter-ship only) |
| 73 | X | X | X | S | 156.675 | | US: Port Operations, Canada: Commercial fishing only, International: Inter-ship, Port operations and Ship movement |
| 74 | X | X | X | S | 156.725 | | US: Port Operations, Canada: Commercial fishing only, International: Inter-ship, Port operations and Ship movement |

| VHF MARINE CHANNEL CHART | | | | | | | |
|--------------------------|----------|----------|---|----------|----------------|---------|---|
| CH | U | C | I | S/D | TX | RX | CHANNEL USE |
| 75 | X | | | S | 156.775 | | Port Operations (Inter-ship only) (1W) |
| 76 | X | | | S | 156.825 | | Port Operations (Inter-ship only) (1W) |
| 77 | X | X | | S | 156.875 | | Port Operations (Inter-ship only) (1W) |
| 77 | | | X | S | 156.875 | | Port Operations (Inter-ship only) |
| 78 | | | X | D | 156.925 | 161.525 | Public Correspondence (Marine Operator), Port operation, ship-movement |
| 78A | X | X | | S | 156.925 | | Non-commercial (Recreational) |
| 79 | | | X | D | 156.975 | 161.575 | Port operation and Ship movement |
| 79A | X | X | | S | 156.975 | | Commercial |
| 80 | | | X | D | 157.025 | 161.625 | Port operation, ship movement |
| 80A | X | X | | S | 157.025 | | Commercial |
| 81 | | | X | D | 157.075 | 161.675 | Port operation, ship movement |
| 81A | X | X | | S | 157.075 | | U.S. Government Only - Environmental protection operations. |
| 82 | | | X | D | 157.125 | 161.725 | Public Correspondence (Marine Operator), Port operation, ship movement |
| 82A | X | X | | S | 157.125 | | U.S. Government Only, Canadian Coast Guard Only |
| 83 | | X | X | D | 157.175 | 161.775 | Canadian Coast Guard Only |
| 83A | X | X | | S | 157.175 | | U.S. Government Only, Canadian Coast Guard Only |
| 83 | | X | X | D | 157.175 | 161.775 | Public Correspondence (Marine Operator) |
| 84 | X | X | X | D | 157.225 | 161.825 | Public Correspondence (Marine Operator) |
| 85 | X | X | X | D | 157.275 | 161.875 | Public Correspondence (Marine Operator) |
| 86 | X | X | X | D | 157.325 | 161.925 | Public Correspondence (Marine Operator) |
| 87 | X | X | X | D | 157.375 | 161.975 | Public Correspondence (Marine Operator) |
| 88 | X | X | X | D | 157.425 | 162.025 | Public Correspondence (ship-to-coast) |
| 88A | X | | | S | 157.425 | | Commercial, Inter-ship Only |
| WX01 | X | X | X | D | --- | 162.550 | Weather (receive only) |
| WX02 | X | X | X | D | --- | 162.400 | Weather (receive only) |
| WX03 | X | X | X | D | --- | 162.475 | Weather (receive only) |
| WX04 | X | X | X | D | --- | 162.425 | Weather (receive only) |
| WX05 | X | X | X | D | --- | 162.450 | Weather (receive only) |
| WX06 | X | X | X | D | --- | 162.500 | Weather (receive only) |
| WX07 | X | X | X | D | --- | 162.525 | Weather (receive only) |
| WX08 | X | X | X | D | --- | 161.650 | Weather (receive only) |
| WX09 | X | X | X | D | --- | 161.775 | Weather (receive only) |
| WX10 | X | X | X | D | --- | 163.275 | Weather (receive only) |

The above **BOLD** channels are not for use of the general public in U.S. waters, unless proper authorization is given.



| Channel designator | Carrier frequency (MHz) | | Points of communication (Intership and between coast and ship unless otherwise indicated) | |
|--|-------------------------|----------------|---|--|
| | Ship transmit | Coast transmit | | |
| Port Operations | | | | |
| 01A ¹ | 156.050 | 156.050 | Intership only. Intership only. | |
| 63A ¹ | 156.175 | 156.175 | | |
| 05 ² | 156.250 | 156.250 | | |
| 65A | 156.275 | 156.275 | | |
| 66A | 156.325 | 156.325 | | |
| 12 ³ | 156.600 | 156.600 | | |
| 73 | 156.675 | 156.675 | | |
| 14 ³ | 156.700 | 156.700 | | |
| 74 | 156.725 | 156.725 | | |
| 77 ⁴ | 156.875 | | | |
| 20A ¹² | 157.000 | | | |
| Navigational (Bridge-to-Bridge)⁵ | | | | |
| 13 ⁶ | 156.650 | 156.650 | | |
| 67 ⁷ | 156.375 | 156.375 | | |
| Commercial | | | | |
| 01A ¹ | 156.050 | 156.050 | Intership only. Do. | |
| 63A ¹ | 156.175 | 156.175 | | |
| 07A | 156.350 | 156.350 | | |
| 67 ⁷ | 156.375 | | | |
| 08 | 156.400 | | | |
| 09 | 156.450 | 156.450 | | |
| 10 | 156.500 | 156.500 | | |
| 11 ³ | 156.550 | 156.550 | | |
| 18A | 156.900 | 156.900 | | |
| 19A | 156.950 | 156.950 | | |
| 79A | 156.975 | 156.975 | | |
| 80A | 157.025 | 157.025 | | |
| 88A ⁸ | 157.425 | | | |
| 72 ¹⁴ | 156.625 | | | |
| Digital Selective Calling | | | | |
| 70 ¹⁵ | 156.525 | 156.525 | | |

| Channel designator | Carrier frequency (MHz) | | Points of communication (Intership and between coast and ship unless otherwise indicated) | |
|-------------------------------------|-------------------------|----------------|---|---|
| | Ship transmit | Coast transmit | | |
| Noncommercial | | | | |
| 68 ¹⁷ | 156.425 | 156.425 | Intership only. Great Lakes only. Do. Internship only. | |
| 09 ¹⁶ | 156.450 | 156.450 | | |
| 69 | 156.475 | 156.475 | | |
| 71 | 156.575 | 156.575 | | |
| 72 | 156.625 | | | |
| 78A | 156.925 | 156.925 | | |
| 79A | 156.975 | 156.975 | | |
| 80A | 157.025 | 157.025 | | |
| 67 ¹⁴ | 156.375 | | | |
| Distress, Safety and Calling | | | | |
| 16 | 156.800 | 156.800 | | EPRIB |
| Intership Safety | | | | |
| 06 | 156.300 | | | a. Intership, or b. For SAR: Ship and aircraft for the U.S. Coast Guard. |
| Environmental | | | | |
| 15 ¹³ | | 156.750 | Coast to ship only. | |
| Maritime Control | | | | |
| 17 ^{9,10} | 156.850 | 156.850 | | |
| Liaison, U.S. Coast Guard | | | | |
| 22A ¹¹ | 157.100 | 157.100 | Ship, aircraft, and coast stations of the U.S. Coast Guard and at Lake Mead, Nev., ship and coast stations of the National Park Service, U.S. Department of the Interior. | |

- 1: 156.050 MHz and 156.175 MHz are available for port operations and commercial communications purposes when used only within the U.S. Coast Guard designated Vessel Traffic Services (VTS) area of New Orleans, on the lower Mississippi River from the various pass entrances in the Gulf of Mexico to Devil's Swamp Light at River Mile 242.4 above head of passes near Baton Rouge.
- 2: 156.250 MHz is available for port operations communications use only within the U.S. Coast Guard designated VTS radio protection areas of New Orleans and Houston described in Sec. 80.383. 156.250 MHz is available for intership port operations communications used only within the area of Los Angeles and Long Beach harbors, within a 25-nautical mile radius of Point Fermin, California.
- 3: 156.550 MHz, 156.600 MHz and 156.700 MHz are available in the U.S. Coast Guard designated port areas only for VTS communications and in the Great Lakes available primarily for communications relating to the movement of ships in sectors designated by the St. Lawrence Seaway Development Corporation or the U.S. Coast Guard. The use of these frequencies outside VTS and ship movement sector protected areas is permitted provided they cause no interference to VTS and ship movement communications in their respective designated sectors.



- 4: Use of 156.875 MHz is limited to communications with pilots regarding the movement and docking of ships. Normal output power must not exceed 1 watt.
- 5: 156.375 MHz and 156.650 MHz are available primarily for intership navigational communications. These frequencies are available between coast and ship on a secondary basis when used on or in the vicinity of locks or drawbridges. Normal output power must not exceed 1 watt. Maximum output power must not exceed 10 watts for coast stations or 25 watts for ship stations.
- 6: On the Great Lakes, in addition to bridge-to-bridge communications, 156.650 MHz is available for vessel control purposes in established vessel traffic systems. 156.650 MHz is not available for use in the Mississippi River from South Pass Lighted Whistle Buoy "2" and Southwest Pass entrance Midchannel Lighted Whistle Buoy to mile 242.4 above Head of Passes near Baton Rouge. Additionally it is not available for use in the Mississippi River-Gulf Outlet, the Mississippi River-Gulf Outlet Canal, and the Inner Harbor Navigational Canal, except to aid the transition from these areas.
- 7: Use of 156.375 MHz is available for navigational communications only in the Mississippi River from South Pass Lighted Whistle Buoy "2" and Southwest Pass entrance Midchannel Lighted Whistle Buoy to mile 242.4 above head of Passes near Baton Rouge, and in addition over the full length of the Mississippi River-Gulf Outlet Canal from entrance to its junction with the Inner Harbor Navigation Canal, and over the ull length of the Inner Harbor Navigation Canal from its junction with the Mississippi River to its entry to Lake Pontchartrain at the New Seabrook vehicular bridge.
- 8: Within 120 km (75 miles) of the United States/Canada border, in the area of the Puget Sound and the Strait of Juan de Fuca and its approaches, 157.425 MHz is half of the duplex pair designated as Channel 88. In this area, Channel 88 is available to ship stations for communications with public coast stations only. More than 120 km (75 miles) from the United States/Canada border in the area of the Puget Sound and the Strait of Juan de Fuca, its approaches, the Great Lakes, and the St. Lawrence Seaway, 157.425 MHz is available for intership and commercial communications. Outside Puget Sound area and its approaches and the Great Lakes, 157.425 MHz is also available for communications between commercial fishing vessels and associated aircraft while engaged in commercial fishing activities.
- 9: When the frequency 156.850 MHz is authorized, it may be used additionally for search and rescue training exercises conducted by state or local governments.
- 10: The frequency 156.850 MHz is additionally available to coast stations on the Great Lakes for transmission of scheduled Coded Marine Weather Forecasts (MAFOR), Great Lakes Weather Broadcast (LAWEB) and nscheduled Notices to Mariners or Bulletins. F3C and J3C emissions are permitted. Coast Stations on the Great Lakes must cease weather broadcasts which cause interference to stations operating on 156.800 MHz until the interference problem is resolved.
- 11: The frequency 157.100 MHz is authorized for search and rescue training exercises by state or local government in conjunction with U.S. Coast Guard stations. Prior U.S. Coast Guard approval is required. Use must cease immediately on U.S. Coast Guard request.
- 12: The duplex pair for channel 20 (157.000/161.600 MHz) may be used for ship to coast station communications.
- 13: Available for assignment to coast stations, the use of which is in accord with an agreed program, for the broadcast of information to ship stations concerning the environmental conditions in which vessels operate, i.e., weather; sea conditions; time signals; notices to mariners; and hazards to navigation.
- 14: Available only in the Puget Sound and the Strait of Juan de Fuca.
- 15: The frequency 156.525 MHz is to be used exclusively for distress, safety and calling using digital selective calling techniques. No other uses are permitted.
- 16: The frequency 156.450 MHz is available for intership, ship and coast general purpose calling by noncommercial vessels, such as recreational boats and private coast stations.
- 17: The frequency 156.425 MHz is assigned by rule to private coast stations in Alaska for facsimile transmissions as well as voice communications.



17 WARRANTY

Marine Products Limited Warranty

STANDARD HORIZON (a division of Vertex Standard) warrants, to the original purchaser only, each new Marine Communications Product ("Product") manufactured and/or supplied by STANDARD HORIZON against defects in materials and workmanship under normal use and service for a period of time from the date of purchase as follows:

Fixed Mount and Portable Transceivers

1 year - if purchased before 01/01/91

3 years - if purchased between 01/01/91 and 01/01/94

3 years Waterproof - if purchased after 01/01/94

Loud hailers

1 year - if purchased before 01/01/91

3 years - if purchased after 01/01/91

Associated Chargers

1 year - if purchased before 01/01/91

3 years - if purchased after 01/01/91

Associated Batteries - 1 year. Note: Batteries will be deemed defective only if storage capacity drops below 80% of rated capacity or if leakage develops.

Associated Accessories - 1 year. Includes: Microphones/Handsets, External Speakers, Antennas, Carrying Accessories, Power Supplies, and Signaling Boards.

To receive warranty service, the purchaser must deliver the Product, transportation and insurance prepaid, to STANDARD HORIZON (a division of Vertex Standard), Attention Marine repairs 10900 Walker Street, Cypress, CA 90630. Include proof of purchase indicating model, serial number, and date of purchase. STANDARD HORIZON will return the Product to the purchaser freight prepaid. Products purchased prior to January 1, 1991 will bear the STANDARD HORIZON warranty terms in effect prior to that date.

In the event of a defect, malfunction or failure of the Product during the warranty period, STANDARD HORIZON's liability for any breach of contract or any breach of express or implied warranties in connection with the sale of Products shall be limited solely to repair or replacement, at its option, of the Product or part(s) therein which, upon examination by STANDARD HORIZON, appear to be defective or not up to factory specifications. STANDARD HORIZON may, at its option, repair or replace parts or subassemblies with new or reconditioned parts and subassemblies. Parts thus repaired or replaced are warranted for the balance of the original applicable warranty.



STANDARD HORIZON will not warrant installation, maintenance or service of the Products. In all instances, STANDARD HORIZON's liability for damages shall not exceed the purchase price of the defective Product.

This warranty only extends to Products sold within the 50 States of the United States of America and the District of Columbia.

STANDARD HORIZON will pay all labor to repair the product and replacement parts charges incurred in providing the warranty service except where purchaser abuse or other qualifying exceptions exist. The purchaser must pay any transportation expenses incurred in returning the Product to STANDARD HORIZON for service.

This limited warranty does not extend to any Product which has been subjected to misuse, neglect, accident, incorrect wiring by anyone other than STANDARD HORIZON, improper installation, or subjected to use in violation of instructions furnished by STANDARD HORIZON, nor does this warranty extend to Products on which the serial number has been removed, defaced, or changed. STANDARD HORIZON cannot be responsible in any way for ancillary equipment not furnished by STANDARD HORIZON which is attached to or used in connection with STANDARD HORIZON's Products, or for the operation of the Product with any ancillary equipment, and all such equipment is expressly excluded from this warranty. STANDARD HORIZON disclaims liability for range, coverage, or operation of the Product and ancillary equipment as a whole under this warranty. STANDARD HORIZON reserves the right to make changes or improvements in Products, during subsequent production, without incurring the obligation to install such changes or improvements on previously manufactured Products.

The implied warranties which the law imposes on the sale of this Product are expressly LIMITED, in duration, to the time period specified above. STANDARD HORIZON shall not be liable under any circumstances for consequential damages resulting from the use and operation of this Product, or from the breach of this LIMITED WARRANTY, any implied warranties, or any contract with STANDARD HORIZON. IN CONNECTION WITH THE SALE OF ITS PRODUCTS, STANDARD HORIZON MAKES NO WARRANTIES, EXPRESS OR IMPLIED AS TO THE MERCHANTABILITY OR FITNESS FOR A PARTICULAR PURPOSE OR OTHERWISE, EXCEPT AS EXPRESSLY SET FORTH HEREIN.

Some states do not allow the exclusion or limitation of incidental or consequential damages, or limitation on how long an implied warranty lasts, so the above limitations or exclusions may not apply. This warranty gives specific legal rights, and there may be other rights which may vary from state to state.



ONLY PRODUCTS SOLD ON OR AFTER JANUARY 1, 1991 ARE COVERED UNDER THE TERMS OF THIS LIMITED WARRANTY.

ON-LINE WARRANTY REGISTRATION

THANK YOU for buying Marine Division of Vertex Standard products! We are confident your new radio will serve your needs for many years!

Please visit **www.standardhorizon.com** to register the **GX3000S** Marine VHF. It should be noted that visiting the Web site from time to time may be beneficial to you, as new products are released they will appear on the STANDARD HORIZON Web site. Also a statement regarding product support should be added to the manual.

Product Support Inquiries

If you have any questions or comments regarding the use of the **GX3000S**, you can visit the STANDARD HORIZON Web site to send an E-Mail or contact the Product Support team at (714) 827-7600 ext 6300 M-F 7:00-5:00PST.

In addition to the warranty, STANDARD HORIZON includes a lifetime "flat rate" and "customer loyalty" programs to provide service after the warranty period has expired. If you wish to obtain the flat rate price for out-of-warranty repair, you must include the information on the Owner's Record with the unit when you return it to your Dealer or to STANDARD HORIZON.

Lifetime Flat Rate Service Program: For the original Owner only, for the lifetime of the unit, STANDARD HORIZON will repair the unit to original specifications.

Note: The flat rate amount is payable by the Owner only if STANDARD HORIZON or the STANDARD HORIZON Dealer determines that a repair is needed. After the repair, a 90-day warranty will be in effect from the date of return of the unit to the Owner.

This service program is not available for equipment which has failed as a result of neglect, accident, breakage, misuse, improper installation or modification, or water damage (depending on the product).

18 SPECIFICATIONS

Performance specifications are nominal, unless otherwise indicated, and are subject to change without notice.

18.1 GENERAL

| | |
|------------------------------|--|
| Channels | All USA, International and Canadian |
| Input Voltage | 13.8 VDC \pm 20% |
| Current Drain | |
| Standby | 0.5 A |
| Receive | 1.5 A |
| Transmit | 5.5 A (Hi); 1.5 A (Lo) |
| Dimensions | 4.3" H x 7.1" W x 4.5" D (110 H x 180 W x 115 D mm) |
| Flush-Mount Dimensions | 3.6" H x 6.5" W x 6" D (92 H x 165 W x 150 D mm) |
| Weight | 3.3 lbs (1.5 kg) |

18.2 TRANSMITTER

| | |
|--|--|
| Frequency Range | 156.025 to 157.425 MHz |
| RF Output | 25 W (Hi); 1 W (Lo) |
| Conducted Spurious Emissions | 80 dB (Hi); 60 dB (Lo) |
| Audio Response | within +1/-3 of a 6 dB/octave pre-emphasis characteristic at 300 to 3000 Hz |
| Audio Distortion | 5 % |
| Modulation | 16K0G3E, for DSC 16K0G2B |
| Frequency Stability (-20°C to +50°C) | \pm 0.0005% |
| FM Hum and Noise | 50 dB |

18.3 RECEIVER

| | |
|---|---|
| Frequency Range | 156.050 to 163.275 MHz |
| Sensitivity | |
| 12 dB SINAD | 0.25 μ V |
| 12 dB SINAD (70 CH Receiver) | 0.28 μ V |
| Squelch Sensitivity (Threshold) | 0.15 μ V |
| Modulation Acceptance Bandwidth | \pm 7.5 kHz |
| Selectivity | |
| Spurious and Image Rejection (TYP.) | -80 dB |
| Intermodulation and Rejection at 12 dB SINAD (TYP.) | -80 dB |
| Audio Output | 4.5 W |
| Audio Response | within + 1/-3 of a 6 dB/octave de-emphasis characteristic at 300 to 3000 Hz (@Receiver Audio Control: Default) |
| Frequency Stability (-20°C to +50°C) | \pm 0.0005 % |
| Channel Spacing | 25 kHz |
| DSC Format | ITU Class D |
| NMEA Input/Output | Output - DSC, DSE Input - GLL, GGA, RMC and GNS |



19 APPENDIX

FOG HORN TIMING CHART

The fog horn function sounds a horn repeatedly until the function is turned off.

| TYPE | PATTERN | USAGE |
|----------|--|--|
| UNDERWAY | <p>One 5-second blasts every 120 seconds.</p> | Motor vessel underway and making way. |
| STOP | <p>Two 5-second blasts (separated by 2 seconds) every 120 seconds.</p> | Motor vessel underway but stopped (not making way). |
| SAIL | <p>One 5-second blasts followed by two 1-second blasts (separated by 2 seconds) every 120 seconds.</p> | Sailing vessel underway, fishing vessel (underway or anchored), vessel not under command, a vessel restricted in her ability to maneuver (underway or at anchor), or a vessel towing or pushing another ahead. |
| TOW | <p>One 5-second blasts followed by three 1-second blasts (separated by 2 seconds) every 120 seconds.</p> | Vessel under tow (manned). |
| AGROUND | <p>One 11-second rings every 60 seconds.</p> | Vessel is aground. |
| ANCHOR | <p>One 5-second rings every 60 seconds.</p> | Vessel is at anchor. |



STANDARD HORIZON

**Marine Division of VERTEX STANDARD
US Headquarters**

10900 Walker Street, Cypress, CA 90630, U.S.A.

www.standardhorizon.com



E M O 1 4 N 1 O 1

Copyright 2006
VERTEX STANDARD CO., LTD.
All rights reserved.

No portion of this manual
may be reproduced
without the permission of
VERTEX STANDARD CO., LTD.

Free Manuals Download Website

<http://myh66.com>

<http://usermanuals.us>

<http://www.somanuals.com>

<http://www.4manuals.cc>

<http://www.manual-lib.com>

<http://www.404manual.com>

<http://www.luxmanual.com>

<http://aubethermostatmanual.com>

Golf course search by state

<http://golfingnear.com>

Email search by domain

<http://emailbydomain.com>

Auto manuals search

<http://auto.somanuals.com>

TV manuals search

<http://tv.somanuals.com>