



CS05/ CS06 HYDRAULIC CHAIN SAW



SAFETY, OPERATION AND MAINTENANCE USER MANUAL



© 2012 Stanley Black & Decker, Inc.
New Britain, CT 06053
U.S.A.
66864 1/2013 Ver. 7

TABLE OF CONTENTS

SAFETY SYMBOLS	4
SAFETY PRECAUTIONS.....	5
ELECTRICAL PRECAUTIONS	7
TOOL STICKERS & TAGS	9
HOSE TYPES.....	10
HOSE RECOMMENDATIONS	11
FIGURE 1. TYPICAL HOSE CONNECTIONS	11
HTMA REQUIREMENTS.....	12
OPERATION.....	13
FIGURE 2. FELLING A TREE	14
FIGURE 3. CROSSCUTTING LOGS WITH PRESSURE ON TOP	15
FIGURE 4. CROSSCUTTING LOGS LARGER THAN BAR LENGTH WITH PRESSURE ON TOP	15
FIGURE 5. CROSSCUTTING LOGS/LIMBS WITH PRESSURE ON BOTTOM	16
FIGURE 6. CROSSCUTTING THICK LOGS WITH PRESSURE ON BOTTOM	16
TOOL PROTECTION & CARE	18
TROUBLESHOOTING	19
SPECIFICATIONS.....	20
ACCESSORIES.....	20
SERVICE TOOLS.....	20
CS05/CS06 PARTS ILLUSTRATION	21
CS05/CS06 PARTS LIST	22

IMPORTANT

To fill out a Product Warranty Recording form, and for information on your warranty, visit Stanleyhydraulic.com and select the Warranty tab.
(NOTE: The warranty recording form must be submitted to validate the warranty).

SERVICING: This manual contains safety, operation, and routine maintenance instructions. Stanley Hydraulic Tools recommends that servicing of hydraulic tools, other than routine maintenance, be performed by an authorized and certified dealer. Please read the following warning.

⚠ WARNING

SERIOUS INJURY OR DEATH COULD RESULT FROM THE IMPROPER REPAIR OR SERVICE OF THIS TOOL.

REPAIRS AND / OR SERVICE TO THIS TOOL MUST ONLY BE DONE BY AN AUTHORIZED AND CERTIFIED DEALER.

For the nearest authorized and certified dealer, call Stanley Hydraulic Tools at the number listed on the back of this manual and ask for a Customer Service Representative.

SAFETY SYMBOLS

Safety symbols and signal words, as shown below, are used to emphasize all operator, maintenance and repair actions which, if not strictly followed, could result in a life-threatening situation, bodily injury or damage to equipment.



This is the safety alert symbol. It is used to alert you to potential personal injury hazards. Obey all safety messages that follow this symbol to avoid possible injury or death.



This safety alert and signal word indicate an imminently hazardous situation which, if not avoided, will result in death or serious injury.



This safety alert and signal word indicate a potentially hazardous situation which, if not avoided, could result in death or serious injury.



This safety alert and signal word indicate a potentially hazardous situation which, if not avoided, could result in death or serious injury.



This signal word indicates a potentially hazardous situation which, if not avoided, may result in property damage.



This signal word indicates a situation which, if not avoided, will result in damage to the equipment.



This signal word indicates a situation which, if not avoided, may result in damage to the equipment.

Always observe safety symbols. They are included for your safety and for the protection of the tool.

LOCAL SAFETY REGULATIONS

Enter any local safety regulations here. Keep these instructions in an area accessible to the operator and maintenance personnel.

SAFETY PRECAUTIONS

Tool operators and maintenance personnel must always comply with the safety precautions given in this manual and on the stickers and tags attached to the tool and hose.

These safety precautions are given for your safety. Review them carefully before operating the tool and before performing general maintenance or repairs.

Supervising personnel should develop additional precautions relating to the specific work area and local safety regulations. If so, place the added precautions in the space provided in this manual.

The model CS05/CS06 Hydraulic Chain Saw will provide safe and dependable service if operated in accordance with the instructions given in this manual. Read and understand this manual and any stickers and tags attached to the tool and hose before operation. Failure to do so could result in personal injury or equipment damage.



- The operator must start in a work area without bystanders. Flying debris can cause serious injury.
- Do not operate the tool unless thoroughly trained or under the supervision of an instructor. Establish a training program for all operators to ensure safe operation.
- Always wear safety equipment such as goggles, ear and head protection, and safety shoes at all times when operating the tool. Use gloves and aprons when necessary.
- The operator must be familiar with all prohibited work areas such as excessive slopes and dangerous terrain conditions.
- Do not inspect, clean or replace any part(s) if the hydraulic power source is connected. Do not inspect or clean the tool while the hydraulic power source is connected. Accidental engagement of the tool can cause serious injury.
- Always connect hoses to the tool hose couplers before energizing the hydraulic power source. Be sure all hose connections are tight and are in good condition.
- Do not operate the tool at oil temperatures above 140 °F/60 °C. Operation at higher temperatures can cause higher than normal temperatures at the tool which can result in operator discomfort.
- Do not operate a damaged, improperly adjusted, or incompletely assembled chain saw. Be sure that the chain stops moving when the control trigger is released.
- Never wear loose clothing that can get entangled in the working parts of the tool.
- Keep all parts of your body away from the chain saw and maintain proper footing and balance at all times.
- **Warning:** Use of this tool on certain materials during demolition could generate dust potentially containing a variety of hazardous substances such as asbestos, silica or lead. Inhalation of dust containing these or other hazardous substances could result in serious injury, cancer or death. Protect yourself and those around you. Research and understand the materials you are cutting. Follow correct safety procedures and comply with all applicable national, state or provisional health and safety regulations relating to them, including, if appropriate arranging for the safe disposal of the materials by a qualified person.
- Do not rely exclusively upon the safety devices built into the saw. As a chain saw user, several steps must be taken to keep your cutting jobs free from accidents or injury.
 - With basic understanding of kickback, you can reduce or eliminate the element of surprise. Sudden surprise contributes to accidents.
 - To avoid personal injury or equipment damage, all tool repair, maintenance and service must only be performed by authorized and properly trained personnel.
 - Keep a good firm grip on the saw with both hands, the right hand on the rear handle and the left hand on the front handle when operating the saw. Use a firm grip with thumbs and fingers encircling the chain saw handles. A firm grip will help reduce kickback and maintain control of the saw. Do not let go.
 - Make sure the area in which you are cutting is free of obstructions. Never allow the nose of the guide bar to contact the log, branch or any obstruction that can be accidentally hit while operating the saw.
 - Never start the tool while it is lying on the ground.
 - Cut at rated operating speeds (gpm).
 - Do not overreach or cut above shoulder height.
 - Follow the manufacturer's sharpening and

SAFETY PRECAUTIONS

- maintenance instructions for the saw chain.
- Only use replacement bars and chains specified by Stanley Hydraulic Tools. Chains must meet the requirements of ANSI B175.1 for low kick-back performance.
- Always be well rested and mentally alert before operating the chain saw.
- Do not allow other persons to be near the chain saw when starting or cutting with the chain saw. Keep bystanders and animals out of the work area.
- Do not start cutting until you have a clear work area, secure footing and a planned escape path from a falling tree.
- Carry the saw with the unit de-energized and the bar and chain to the rear of your body.
- Use extreme caution when cutting small size brush and saplings. Twigs may catch the saw chain and be whipped toward the operator or pull the operator off balance.
- When cutting a limb that is under tension, be alert for springback so that you will not be struck when the tension on the limb is released.
- Keep the handles dry, clean and free of oil.
- Do not operate a chain saw while in a tree unless you have been specially trained to do so.
- When using tools near energized transmission lines, be sure to use only hoses labeled and certified non-conductive.
- Turn off the power unit or move the hydraulic control valve to neutral before setting the saw down.
- Use a guide bar scabbard when transporting the saw.
- Know the location of buried or covered electrical services before starting work.
- To avoid personal injury or equipment damage, all tool repair, maintenance and service must only be performed by authorized and properly trained personnel.

ELECTRICAL PRECAUTIONS

The following guidelines must be followed to prevent accidental contact with overhead electrical conductors and/or communication wires and cables. (ref. ANSI Z133.1-2000)

Working in Proximity to Electrical Hazards:

An inspection shall be made by a qualified arborist to determine whether an electrical hazard exists before climbing, or otherwise entering, or performing work in or on a tree.

Only qualified line-clearance arborists or qualified line-clearance arborist trainees shall be assigned to work where an electrical hazard exists. Qualified line-clearance arborist trainees shall be under the direct supervision of qualified line-clearance arborist.

A second qualified line-clearance arborists or line-clearance arborist trainees shall be within vision or voice communication during line-clearing operations aloft when line-clearance arborists or line-clearance arborist trainees must approach closer than 10 feet (3.05 meters) to any energized electrical conductor in excess of 750 volts (primary conductor) or when:

1. Branches or limbs being removed cannot first be cut (with a pole pruner/pole saw) to sufficiently clear electrical conductors, so as to avoid contact.
2. Roping is required to remove branches or limbs from such electrical conductors. This does not apply to individuals working on behalf of, or employed by, electrical system owners/operators engaged in line-clearing operations incidental to their normal occupation.

Qualified line-clearance arborists and line-clearance arborist trainees shall maintain minimum approach distances from energized electrical conductors in accordance with Table 1.

All other arborists shall maintain a minimum approach distance from energized electrical conductors in accordance with Table 2.

Branches hanging on an energized electrical conductor shall be removed using non-conductive equipment.

Table 1 – Minimum approach distances from energized conductors for qualified line-clearance arborists and qualified line-clearance arborist trainees.

Nominal Voltage (kV phase-to-phase)	Includes 1910.269 elevation factor, sea level to 5000 ft ¹		Includes 1910.269 elevation factor, 5001 – 10,000 ft ¹		Includes 1910.269 elevation factor, 10,000 – 14,000 ft ¹	
	ft-in	m	ft-in	m	ft-in	m
0.05 to 1.0	Avoid contact		Avoid contact		Avoid contact	
1.1 to 15.0	2-04	0.71	2-08	0.81	2-10	0.86
15.1 to 36.0	2-09	0.84	3-02	0.97	3-05	1.04
36.1 to 46.0	3-00	0.92	3-05	1.04	3-09	1.14
46.1 to 72.5	3-09	1.14	4-03	1.30	4-07	1.40
72.6 to 121.0	4-06	1.37	5-02	1.58	5-07	1.70
138.0 to 145.0	5-02	1.58	5-11	1.80	6-05	1.96
161.0 to 169.0	6-00	1.83	6-10	2.08	7-05	2.26
230.0 to 242.0	7-11	2.41	9-00	2.75	9-09	2.97
345.0 to 362.0	13-02	4.02	15-00	4.58	16-03	4.96
500.0 to 550.0	19-00	5.80	21-09	6.63	23-06	7.17
765.0 to 800.0	27-04	8.34	31-03	9.53	33-10	10.32

¹ Exceeds phase-to-ground; elevation factor per 29 CFR 1910.269.

ELECTRICAL PRECAUTIONS

Table 2 – Minimum approach distances to energized conductors for persons other than qualified line-clearance arborists and qualified line-clearance arborist trainees.

Nominal Voltage kV phase-to-phase ¹	Distance	
	ft-in	m
0.0 to 1.0	10–00	3.05
1.1 to 15.0	10–00	3.05
15.1 to 36.0	10–00	3.05
36.1 to 50.0	10–00	3.05
50.1 to 72.5	10–09	3.28
72.6 to 121.0	12–04	3.76
138.0 to 145.0	13–02	4.00
161.0 to 169.0	14–00	4.24
230.0 to 242.0	16–05	4.97
345.0 to 362.0	20–05	6.17
500.0 to 550.0	26–08	8.05
785.0 to 800.0	35–00	10.55
¹ Exceeds phase-to-ground.		

The tie-in position should be above the work area and located in such a way that a slip would swing the arborist away from any energized electrical conductors or other identified hazard.

While climbing, the arborist should climb on the side of the tree that is away from energized electrical conductors as required in Tables 1 and 2.

Footwear, including lineman's overshoes, having electrical-resistant soles, shall not be considered as providing any measure of safety from electrical hazards.

Rubber gloves, with or without leather or other protective covering, shall not be considered as providing any measure of safety from electrical hazards.

Ladders, platforms and aerial devices, including insulated aerial devices, shall be subject to minimum approach distances in Table 1 and 2.

Aerial devices and attached equipment (such as chipper) contacting energized electrical conductors shall be considered energized. Contact shall be avoided, except where emergency rescue procedures are being carried out. Emergency rescue should be performed in accordance with 4.3.

STORM WORK AND EMERGENCY CONDITIONS-LINE CLEARANCE

Line clearance shall not be performed during adverse weather conditions such as thunderstorms, high winds and snow and ice storms.

Qualified line-clearance arborists and qualified line-clearance arborists trainees performing line clearance in the aftermath of a storm or under similar conditions shall be trained in the special hazards associated with this type of work.

Line-clearance operations shall be suspended when storm work or emergency conditions develop involving energized electrical conductors. Electrical system owners/operators shall be notified immediately.

TOOL STICKERS & TAGS

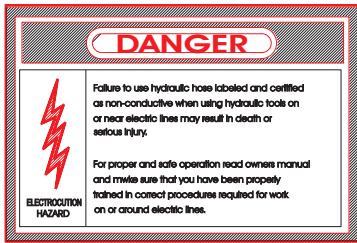

12412
Electrical Warning Decal



28409
Composite Decal
(CE Models Only)



11207
Circuit Type D Decal
(CE Models Only)

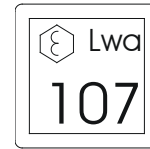

17784
101 Sound Level
Decal
(CE Models Only)



28323
CE Decal
(CE Models Only)



03782
GPM Decal – CS05 Model

03786
GPM Decal – CS06 Model (Not Shown)

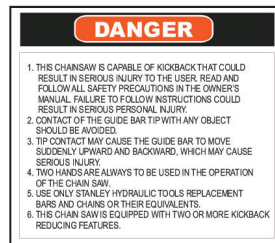

13907
Kickback Warning Decal

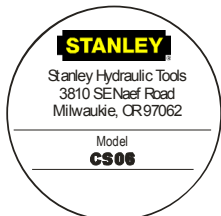

07636
Name Tag

THIS CHAIN SAW IS EQUIPPED WITH AN AUTOMATIC CHAIN OILER. SEE YOUR PARTS & SERVICE BOOK FOR PROPER ADJUSTING PROCEDURES

04746
Auto Oiler Decal

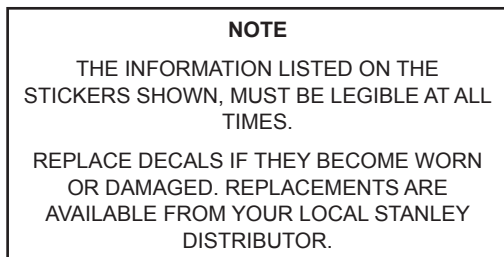

The safety tag (P/N 15875) at right is attached to the tool when shipped from the factory. Read and understand the safety instructions listed on this tag before removal. We suggest you retain this tag and attach it to the tool when not in use.

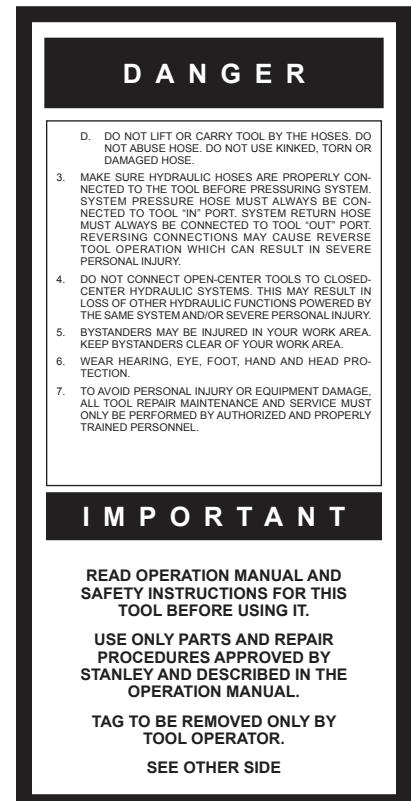
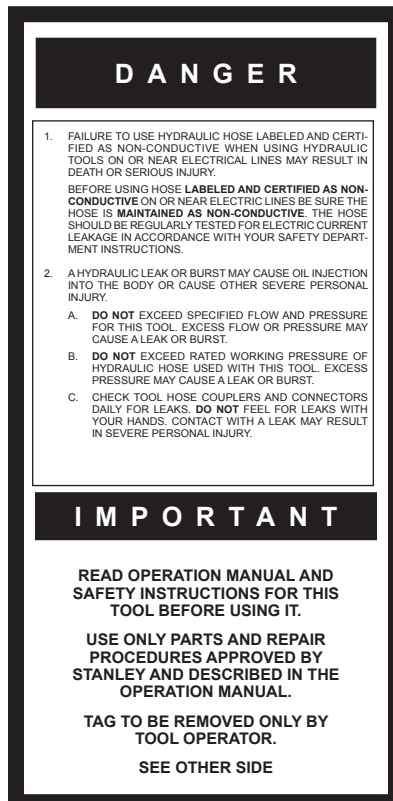

SAFETY TAG P/N 15875 (Shown smaller than actual size)

HOSE TYPES

The rated working pressure of the hydraulic hose must be equal to or higher than the relief valve setting on the hydraulic system. There are three types of hydraulic hose that meet this requirement and are authorized for use with Stanley Hydraulic Tools. They are:

Certified non-conductive — constructed of thermoplastic or synthetic rubber inner tube, synthetic fiber braid reinforcement, and weather resistant thermoplastic or synthetic rubber cover. *Hose labeled **certified non-conductive** is the only hose authorized for use near electrical conductors.*

Wire-braided (conductive) — constructed of synthetic rubber inner tube, single or double wire braid reinforcement, and weather resistant synthetic rubber cover. *This hose is **conductive** and must never be used near electrical conductors.*

Fabric-braided (not certified or labeled non-conductive) — constructed of thermoplastic or synthetic rubber inner tube, synthetic fiber braid reinforcement, and weather resistant thermoplastic or synthetic rubber cover. *This hose is **not certified non-conductive** and must never be used near electrical conductors.*

HOSE SAFETY TAGS

To help ensure your safety, the following DANGER tags are attached to all hose purchased from Stanley Hydraulic Tools. DO NOT REMOVE THESE TAGS.

If the information on a tag is illegible because of wear or damage, replace the tag immediately. A new tag may be obtained from your Stanley Distributor.

THE TAG SHOWN BELOW IS ATTACHED TO “CERTIFIED NON-CONDUCTIVE” HOSE

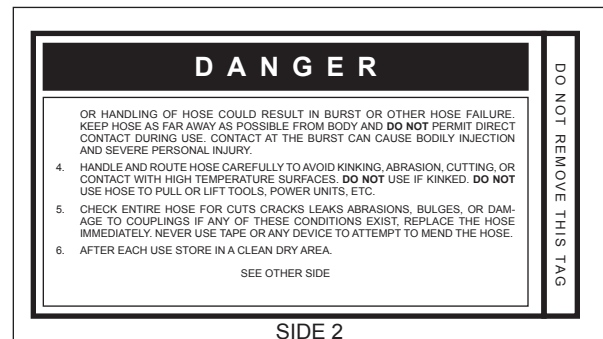
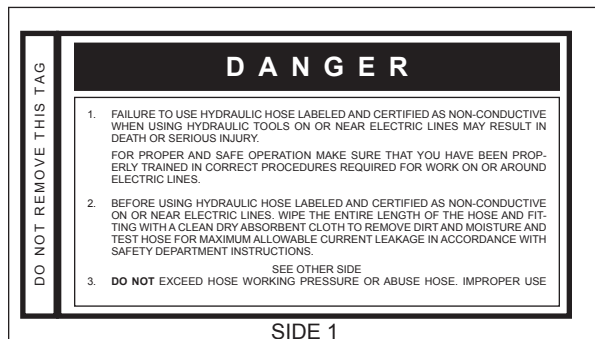

(Shown smaller than actual size)

THE TAG SHOWN BELOW IS ATTACHED TO “CONDUCTIVE” HOSE.

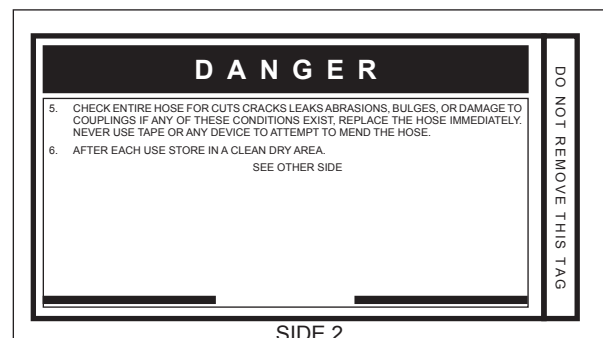
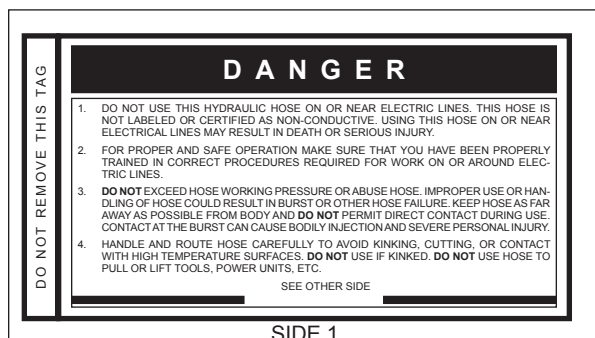

(Shown smaller than actual size)

Tool to Hydraulic Circuit Hose Recommendations

The chart to the right shows recommended minimum hose diameters for various hose lengths based on gallons per minute (gpm)/liters per minute (lpm). These recommendations are intended to keep return line pressure (back pressure) to a minimum acceptable level to ensure maximum tool performance.

This chart is intended to be used for hydraulic tool applications only based on Stanley Hydraulic Tools tool operating requirements and should not be used for any other applications.

All hydraulic hose must have at least a rated minimum working pressure equal to the maximum hydraulic system relief valve setting.

All hydraulic hose must meet or exceed specifications as set forth by SAE J517.

Oil Flow		Hose Lengths		Inside Diameter		USE (Press/Return)	Min. Working Pressure	
GPM	LPM	FEET	METERS	INCH	MM		PSI	BAR
Certified Non-Conductive Hose - Fiber Braid - for Utility Bucket Trucks								
4-9	15-34	up to 10	up to 3	3/8	10	Both	2250	155
Conductive Hose - Wire Braid or Fiber Braid - DO NOT USE NEAR ELECTRICAL CONDUCTORS								
4-6	15-23	up to 25	up to 7.5	3/8	10	Both	2500	175
4-6	15-23	26-100	7.5-30	1/2	13	Both	2500	175
5-10.5	19-40	up to 50	up to 15	1/2	13	Both	2500	175
5-10.5	19-40	51-100	15-30	5/8	16	Both	2500	175
5-10.5	19-40	100-300	30-90	5/8	16	Pressure	2500	175
10-13	38-49	up to 50	up to 15	3/4	19	Return	2500	175
10-13	38-49	51-100	15-30	5/8	16	Both	2500	175
10-13	38-49	100-200	30-60	3/4	19	Pressure	2500	175
13-16	49-60	up to 25	up to 8	5/8	16	Pressure	2500	175
13-16	49-60	26-100	8-30	3/4	19	Return	2500	175
				1	25.4	Return	2500	175
				5/8	16	Pressure	2500	175
				3/4	19	Return	2500	175
				3/4	19	Pressure	2500	175
				1	25.4	Return	2500	175

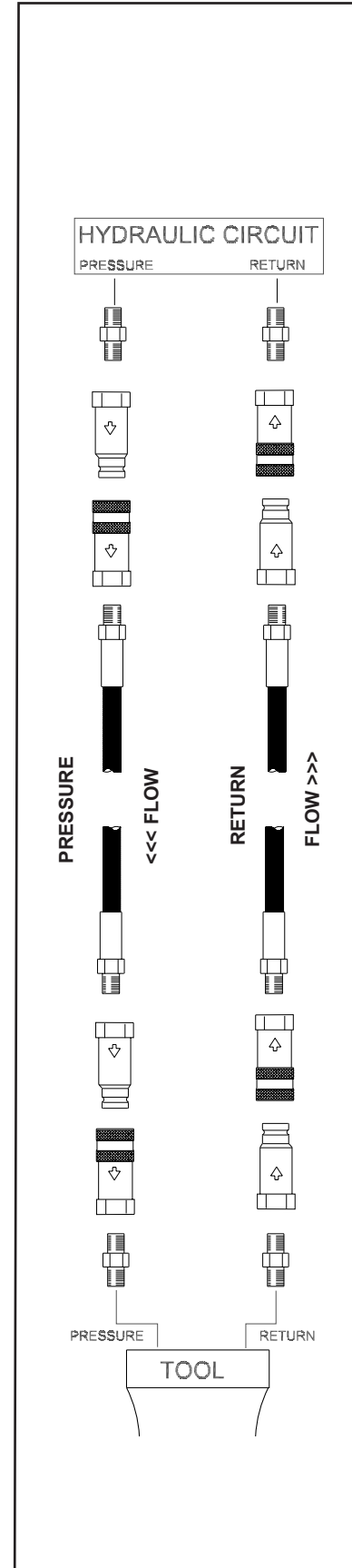

Figure 1. Typical Hose Connections

HTMA REQUIREMENTS

HTMA / EHTMA REQUIREMENTS

HTMA





HYDRAULIC SYSTEM REQUIREMENTS

TOOL TYPE

	TYPE I	TYPE II	TYPE RR	TYPE III
Flow Range	4-6 gpm (15-23 lpm)	7-9 gpm (26-34 lpm)	9-10.5 gpm (34-40 lpm)	11-13 gpm (42-49 lpm)
Nominal Operating Pressure (at the power supply outlet)	1500 psi (103 bar)	1500 psi (103 bar)	1500 psi (103 bar)	1500 psi (103 bar)
System relief valve setting (at the power supply outlet)	2100-2250 psi (145-155 bar)	2100-2250 psi (145-155 bar)	2200-2300 psi (152-159 bar)	2100-2250 psi (145-155 bar)
Maximum back pressure (at tool end of the return hose)	250 psi (17 bar)	250 psi (17 bar)	250 psi (17 bar)	250 psi (17 bar)
Measured at a max. fluid viscosity of: (at min. operating temperature)	400 ssu* (82 centistokes)	400 ssu* (82 centistokes)	400 ssu* (82 centistokes)	400 ssu* (82 centistokes)
Temperature: Sufficient heat rejection capacity to limit max. fluid temperature to: (at max. expected ambient temperature)	140° F (60° C)	140° F (60° C)	140° F (60° C)	140° F (60° C)
Min. cooling capacity at a temperature difference of between ambient and fluid temps	3 hp (2.24 kW) 40° F (22° C)	5 hp (3.73 kW) 40° F (22° C)	6 hp (5.22 kW) 40° F (22° C)	7 hp (4.47 kW) 40° F (22° C)
NOTE: Do not operate the tool at oil temperatures above 140° F (60° C). Operation at higher temperatures can cause operator discomfort at the tool.				
Filter Min. full-flow filtration Sized for flow of at least: (For cold temp. startup and max. dirt-holding capacity)	25 microns 30 gpm (114 lpm)	25 microns 30 gpm (114 lpm)	25 microns 30 gpm (114 lpm)	25 microns 30 gpm (114 lpm)
Hydraulic fluid Petroleum based (premium grade, anti-wear, non-conductive) Viscosity (at min. and max. operating temps)	100-400 ssu*	100-400 ssu* (20-82 centistokes)	100-400 ssu*	100-400 ssu*
NOTE: When choosing hydraulic fluid, the expected oil temperature extremes that will be experienced in service determine the most suitable temperature viscosity characteristics. Hydraulic fluids with a viscosity index over 140 will meet the requirements over a wide range of operating temperatures.				
*SSU = Saybolt Seconds Universal				

EHTMA HYDRAULIC SYSTEM REQUIREMENTS

CLASSIFICATION

					
Flow Range	3.5-4.3 gpm (13.5-16.5 lpm)	4.7-5.8 gpm (18-22 lpm)	7.1-8.7 gpm (27-33 lpm)	9.5-11.6 gpm (36-44 lpm)	11.8-14.5 gpm (45-55 lpm)
Nominal Operating Pressure (at the power supply outlet)	1870 psi (129 bar)	1500 psi (103 bar)	1500 psi (103 bar)	1500 psi (103 bar)	1500 psi (103 bar)
System relief valve setting (at the power supply outlet)	2495 psi (172 bar)	2000 psi (138 bar)	2000 psi (138 bar)	2000 psi (138 bar)	2000 psi (138 bar)

NOTE: These are general hydraulic system requirements. See tool specification page for tool specific requirements

PREOPERATION PROCEDURES

CHECK POWER SOURCE

1. Using a calibrated flowmeter and pressure gauge, check that the hydraulic power source develops a flow of 4-6 gpm/15-23 lpm at 1500-2000 psi/105-140 bar for the CS05 or a flow of 7-9 gpm/26-34 lpm at 1000-2000 psi/70-140 bar for the CS06.
2. Make certain that the hydraulic power source is equipped with a relief valve set to open at 2100-2250 psi/145-155 bar.

CONNECT HOSES

1. Wipe all hose couplers with a clean lint-free cloth before making connections.
2. Connect the hoses from the hydraulic power source to the tool fittings or quick disconnects. It is good practice to connect return hoses first and disconnect them last to minimize or avoid trapped pressure within the tool.
3. Observe the arrow on the couplers to ensure that the flow is in the proper direction. The female coupler on the tool hose is the inlet (pressure) coupler.
4. Move the hydraulic circuit control valve to the "ON" position to operate the tool.

NOTE:

If uncoupled hoses are left in the sun, pressure increase inside the hose may make them difficult to connect. Whenever possible, connect the free ends of the hoses together.

SYSTEM SELECTION (OC/CC)

Saws configured with the system selector option require setup for the system, closed-center (CC) or open-center (OC), in which it will operate. The selector screw is located in the bottom end of the valve spool.

1. Determine the system type.
2. For operation in a CC system, turn the selector screw fully clockwise. When the selector screw bottoms, CC operation is selected.
3. For operation in an OC system, turn the selector screw counter-clockwise until meeting resistance (from the retaining ring). Turn the selector screw clockwise and then counter-clockwise to be sure that you are sensing resistance of the retaining ring. Do not force the selector screw.

IMPORTANT

To prevent damage to the retaining ring, do not attempt to force the selector screw counter-clockwise beyond the point of initial resistance.

OPERATING PROCEDURES

The following are general wood cutting procedures and techniques. Differences in the terrain, vegetation, and type of wood will make this information more or less valid for particular areas. For advice on specific woodcutting problems or techniques for your area, consult your local Stanley representative or your county agent. They can often provide information that will make your work safer and more productive.

CUTTING TIPS

1. Check the lean of the tree. Tie a weight to a piece of string about 2 feet long. Hang the weight in your line of sight. The string is a good vertical line to help you judge the lean of the tree. The tree should fall the way it is leaning. Trees that are straight (leaning no more than 5 degrees) generally can be felled in any direction.
2. Avoid felling across another tree, log, rocks, gully or ridge. Do not fell straight uphill or downhill. Fell the tree diagonally to the hill. Consider the wind direction and velocity. Do not attempt cutting in strong winds.
3. Check the weight distribution. A tree is heavier on the side with the most limbs. It will try to fall on its heavy side. Trim a few limbs to "balance" the tree.
4. Clear the work area. You need a clean area all around the tree for good footing. Get everything out of the area where the tree will fall. Do not cut trees near structures. Because of the danger of electrocution, use extreme care when cutting trees near power lines.
5. Before starting the cut, prepare your escape path. Make sure the escape path is clear of brush and branches. The escape path should be at an angle away from the direction of fall.

OPERATION

- The saw chain should cut with very little pressure applied to the handle. If you have to force the saw to cut or if the cut is not straight, cease cutting immediately to prevent further saw chain and bar damage. See the Maintenance and Adjustments section of the Service Manual for chain replacement or adjustment procedures.
- Underwater models require daily preventive maintenance. See the Maintenance and Adjustments section of the Service Manual for these maintenance procedures.

FELLING (CUTTING DOWN A TREE) (FIGURE 2)

Observe all safety precautions.

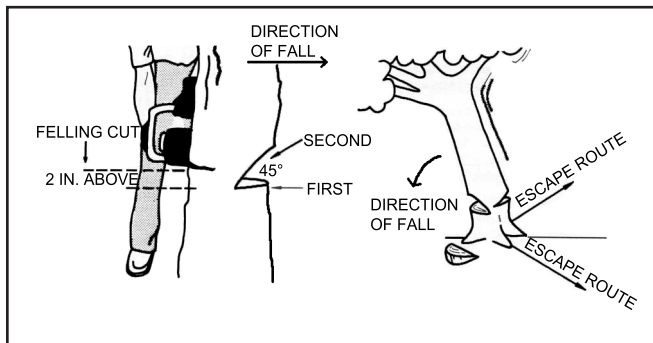

Figure 2. Felling a Tree

NOTCHING OR UNDERCUTTING

- The notching or undercutting cut is made on the side you want the tree to fall. Place the saw so the hand guard is close to the tree trunk and the bucking cleat is dug in.
- Start the cut horizontally. Pivot the nose of the bar in last. Cut to about one-quarter of the tree's diameter.

⚠ WARNING

Watch out for falling limbs.

- Make a diagonal cut down to meet the horizontal cut and remove the wood from the notch.

FELLING OR BACK CUT

- The felling or back cut is made on the side opposite and at least 2 inches above the horizontal undercut (the felling cut is made higher as the size of the tree increases). Place the saw so the hand guard is close to the tree trunk and the bucking cleat is dug in.
- Start the cut horizontally. Pivot the bar in until the cut is being made parallel to the notch cut. Cut until the saw is about 1 or 2 inches from the notch. Do not cut through the notch.

NOTE:

The uncut wood between the felling and notch cuts is called the hinge. The hinge controls the fall of the tree and should be of uniform thickness.

- As the saw nears the back cut, watch the treetop and the cut for signs of movement. Be alert as soon as the tree starts to move, turn off the saw, pull it from the tree and move away quickly on your escape route.
- For trees larger than bar length, make two felling cuts. Cut in as far as the bar will go, move to the other side and start the second cut in the same manner as the first while pivoting the saw to complete the felling cut.

BUCKING

Bucking is the sawing of a log or fallen tree into smaller pieces.

- Observe all safety precautions.
- Use both hands. Grip the saw firmly.
- Stand uphill. A log that is cut loose may roll downhill.
- Keep the chain out of the dirt. Dirt will dull the chain. A dull chain is unsafe.
- Stand to the left of the saw.

CROSSCUTTING

NOTE:

Before starting to cut through a log try to imagine what is going to happen. Look out for stresses in the log and cut through the log in such a manner that the guide bar will not get pinched.

LOGS WITH PRESSURE ON TOP (FIGURE 3)

1. Observe all safety precautions.
2. Begin with an upper cut, down from the top. Do not cut too deeply. A cut of about 1/3 of the log diameter is enough.
3. Finish with a bottom cut. They should meet.

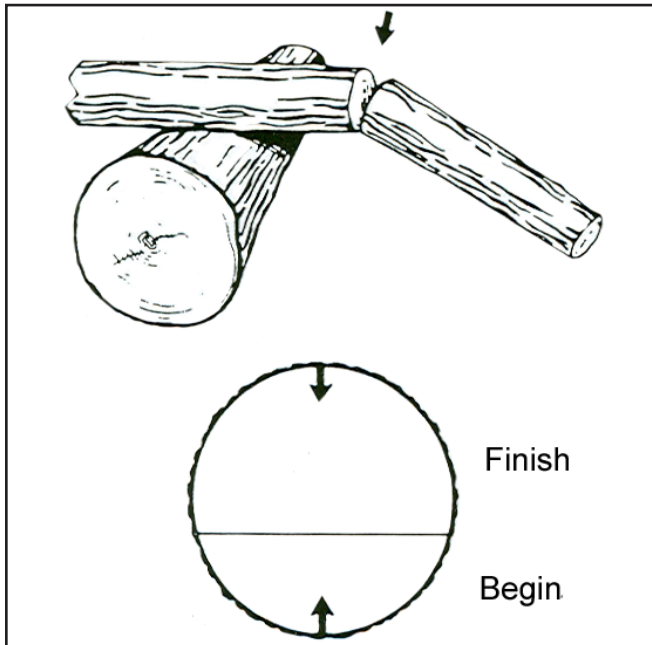

Figure 3. Crosscutting Logs with Pressure on Top

THICK LOGS LARGER THAN BAR LENGTH WITH PRESSURE ON TOP (FIGURE 4)

1. Observe all safety precautions.
2. Begin by cutting on the opposite side of the log.
3. Pull the saw towards you and cut from the top.
4. Cut from the bottom. Make a boring cut if the log is close to the ground.
5. Finish with a bottom cut.

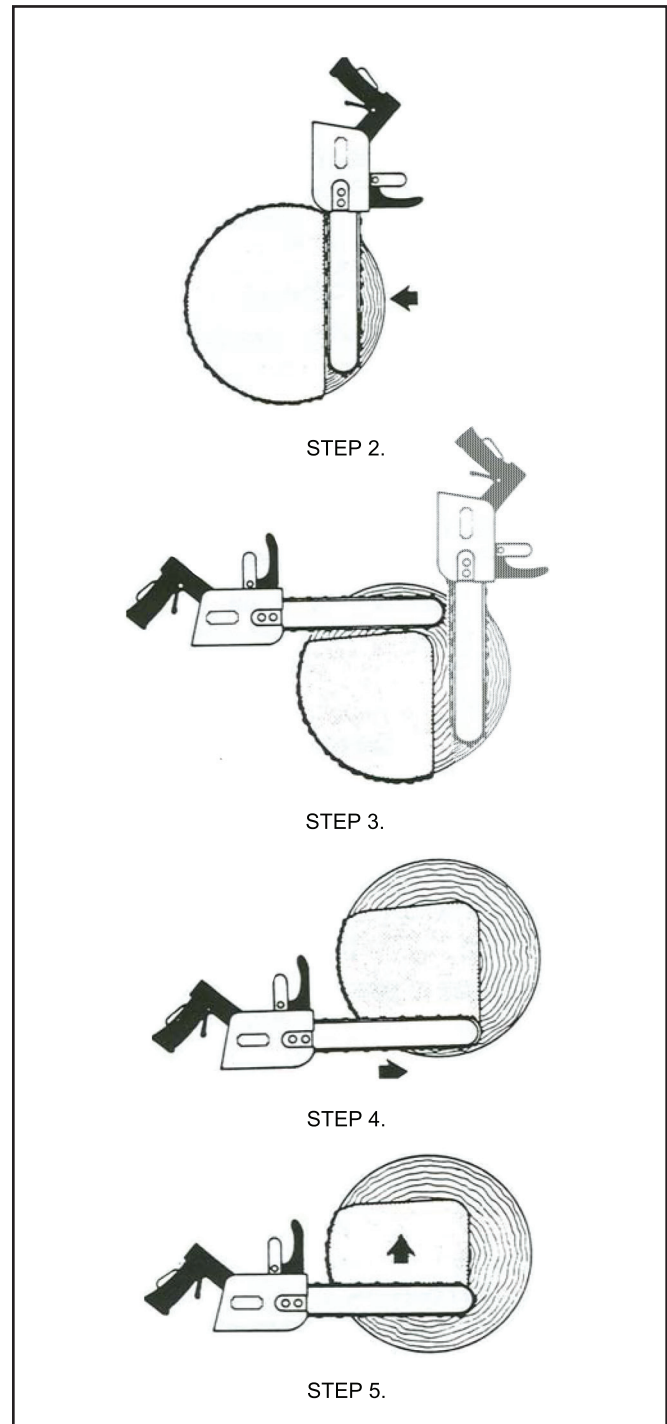

Figure 4. Crosscutting Logs Larger than Bar Length With Pressure on Top

OPERATION

LOGS/LIMBS WITH PRESSURE ON BOTTOM (FIGURE 5)

1. Observe all safety precautions.
2. Begin with a bottom cut. The depth of the cut should be about 1/3 of the log diameter.
3. Finish with an upper cut, down from the top. The saw cuts should meet.

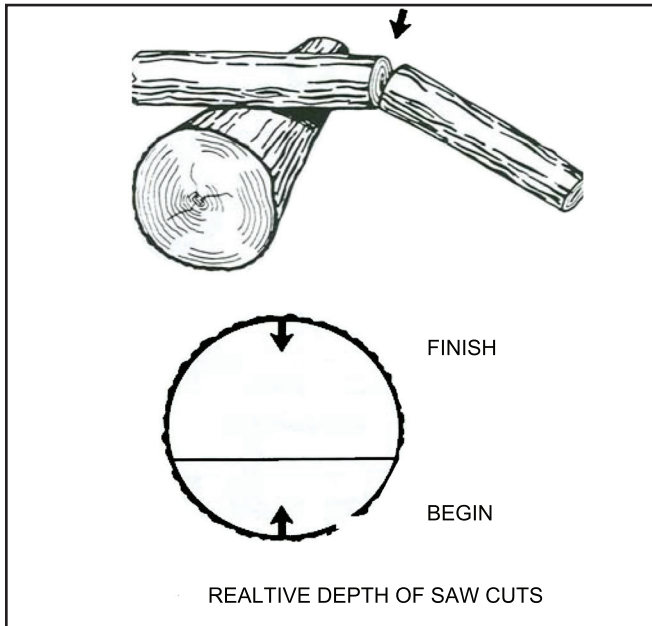

Figure 5. Crosscutting Logs/Limbs with Pressure on Bottom.

THICK LOGS LARGER THAN BAR LENGTH WITH PRESSURE ON THE BOTTOM (FIGURE 6)

1. Observe all safety precautions.
2. Begin by cutting on the opposite side of the log.
3. Pull the saw towards you and cut from the top.
4. Cut from the bottom. Make a boring cut if the log is close to the ground.
5. Finish with a top cut.

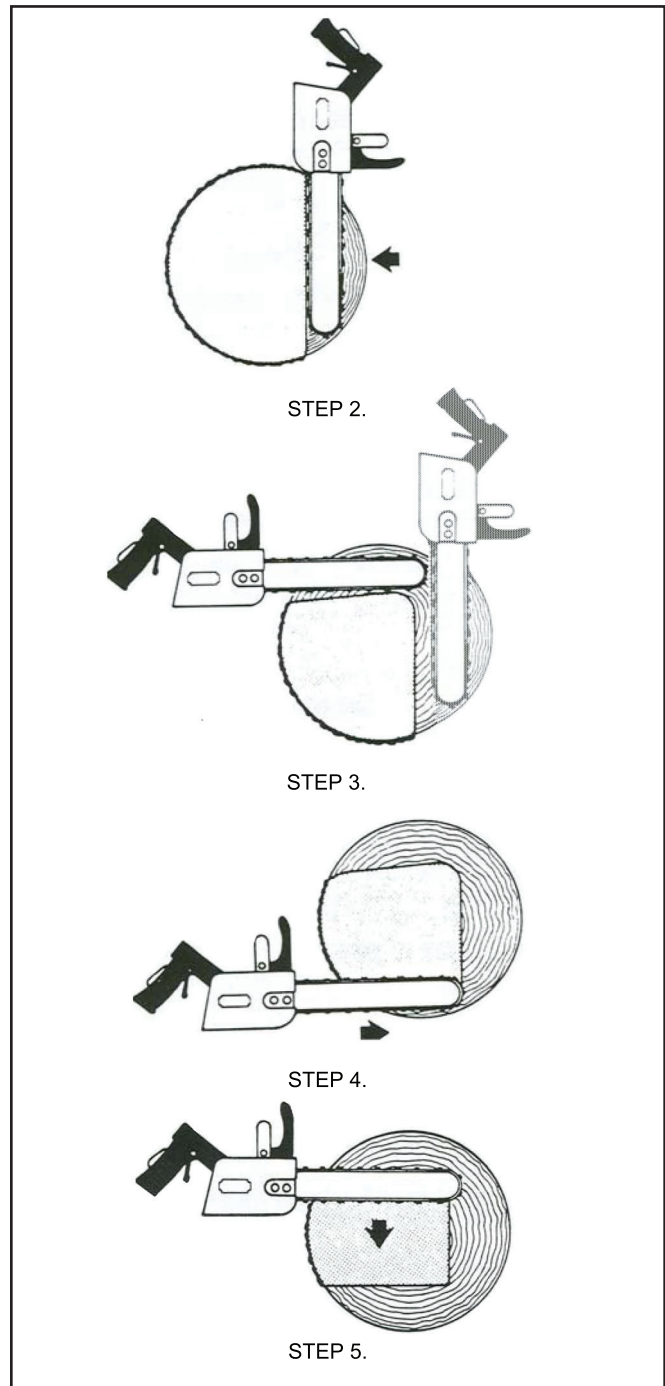

Figure 6. Crosscutting Thick Logs with Pressure on Bottom

PRUNING AND DEBRANCHING

1. Observe all safety precautions.
2. Use both hands. Keep a firm grip.
3. Be alert for kickback. Do not allow the tip of the bar to touch anything while the chain is in motion.
4. Do not cut overhead. Keep the saw below chest level. The chain is too close to your face in this position.

COLD WEATHER OPERATION

If the saw is to be used during cold weather, preheat the hydraulic fluid at low engine speed. When using the normally recommended oils, oil should be at or above 50 °F/10 °C (400 ssu/ 82 centistokes) before use.

Damage to the hydraulic system or saw can result from use with fluid that is too viscous or thick.

Cutting frozen wood causes the cutters to wear, crack and break at the back rivet hole unless proper precautions are taken. To extend chain life when cutting in cold weather:

1. Be sure the oiler is working.
2. Keep the chain tensioned and check often.
3. Keep the cutters properly sharpened. Touch up at least every hour. Never force a dull chain to cut.
4. Clean out the bar groove and keep the oil hole open. Turn the bar over to equalize wear on the rails.
5. Always install a new sprocket with a new chain.

TOOL PROTECTION & CARE

NOTICE

In addition to the Safety Precautions found in this manual, observe the following for equipment protection and care.

- Make sure all couplers are wiped clean before connection.
- The hydraulic circuit control valve must be in the "OFF" position when coupling or uncoupling hydraulic tools. Failure to do so may result in damage to the quick couplers and cause overheating of the hydraulic system.
- Always store the tool in a clean dry space, safe from damage or pilferage.
- Make sure the circuit PRESSURE hose (with male quick disconnect) is connected to the "IN" port. The circuit RETURN hose (with female quick disconnect) is connected to the opposite port. Do not reverse circuit flow. This can cause damage to internal seals.
- Always replace hoses, couplings and other parts with replacement parts recommended by Stanley Hydraulic Tools. Supply hoses must have a minimum working pressure rating of 2500 psi/172 bar.
- Do not exceed the rated flow (see Specifications) page in this manual for correct flow rate and model number. Rapid failure of the internal seals may result.
- Always keep critical tool markings, such as warning stickers and tags legible.
- Tool repair should be performed by experienced personnel only.
- Make certain that the recommended relief valves are installed in the pressure side of the system.
- Do not use the tool for applications for which it was not intended.

TROUBLESHOOTING

If symptoms of poor performance develop, the following chart can be used as a guide to correct the problem. When diagnosing faults in operation of the saw, always make sure the hydraulic power source is supplying the correct hydraulic flow and pressure to the saw as listed in the table. Use a flowmeter known to be accurate. Check the flow with the hydraulic fluid temperature at least 80 °F/27 °C.

PROBLEM	CAUSE	REMEDY
Cuts slow.	Insufficient fluid flow or low relief valve setting.	Adjust fluid flow to proper gpm. For optimum performance adjust relief valve to 2250 psi/155 psi.
	Chain dull.	Sharpen per instructions or replace.
	Backpressure too high.	Should not exceed 250 psi/17 bar at 8 gpm/30 lpm measured at the end of the tool operating hoses.
Bar turns color.	Insufficient oiler flow.	Adjust oiler per Service Manual.
Tool does not run.	Power unit not functioning.	Check power unit for proper flow and pressure (4 gpm/15 lpm at 1500 psi/104 bar minimum for the CS05 and 7 gpm/26 lpm at 1000 psi/70 bar for the CS06).
	Coupler or hoses blocked.	Remove obstruction.
	Mechanical failure.	Disassemble tool and inspect for damage.
Tool runs backwards.	Pressure and return reversed.	Connect for proper flow direction. Motor shaft rotates clockwise.
On/Off trigger is hard to press.	Pressure and return reversed.	Correct for proper flow direction.
	Backpressure too high.	Should not exceed 250 psi/17 bar at 8 gpm/30 lpm measured at the end of the tool operating hoses.
Oil leakage around drive sprocket.	Motor shaft seal failure.	Replace as required. Make sure that oil present is not the result of excess oiler flow.
Oil leakage between rear gear housing and valve handle assembly.	Motor face seal failure.	Replace as required.
Chain continues to move after valve is shut off.	Chain is too loose.	Tighten chain.
	Input flow too high.	Decrease flow.

SPECIFICATIONS

Capacity	
CS05	12 and 15 inch/30 and 38 cm Cut Lengths
CS06	12, 15 and 20 inch/30, 38 and 51 cm Cut Lengths
Weight (w/o bar)	6.25 lbs/2.8 kg
Length (w/o bar)	14 inches/36 cm
Width	9 inches/23 cm
Pressure	
CS05	1500-2000 psi/105-140 bar
CS06	1000-2000 psi/26-34 lpm
Optimum Flow	
CS05	5 gpm/19 lpm
CS06	8 gpm/30 lpm
Porting	8 SAE O-ring
Connect Size and Type	3/8 inch NPT Male Adapter
Hose Whips	No
Motor	Integral
Kickback Reduction Features	
.....	Low Kickback Saw Chain, Small Radius Saw Bar, Front Hand Guard, Low Inertia Motor/Drive System
Sound Power Level	107 dBA
Sound Pressure Level @ 1 meter	93.1 dBA
Vibration Level.....	3.1 (m/s ²)

ACCESSORIES

Rim Sprocket, .325 P × 7 Tooth	07629
12-inch Saw Bar	08347
15-inch Saw Bar	07638
20-inch Saw Bar	07639
Saw Chain for 12-inch Bar.....	08348
Saw Chain for 15-inch Bar.....	07641
Saw Chain for 20-inch Bar.....	07642
File Guide with File	12363
Flat File.....	11294
Scrench	11464

SERVICE TOOLS

O-ring Tool Kit.....	04337
Seal Kit.....	07830

CS05/CS06 PARTS ILLUSTRATION

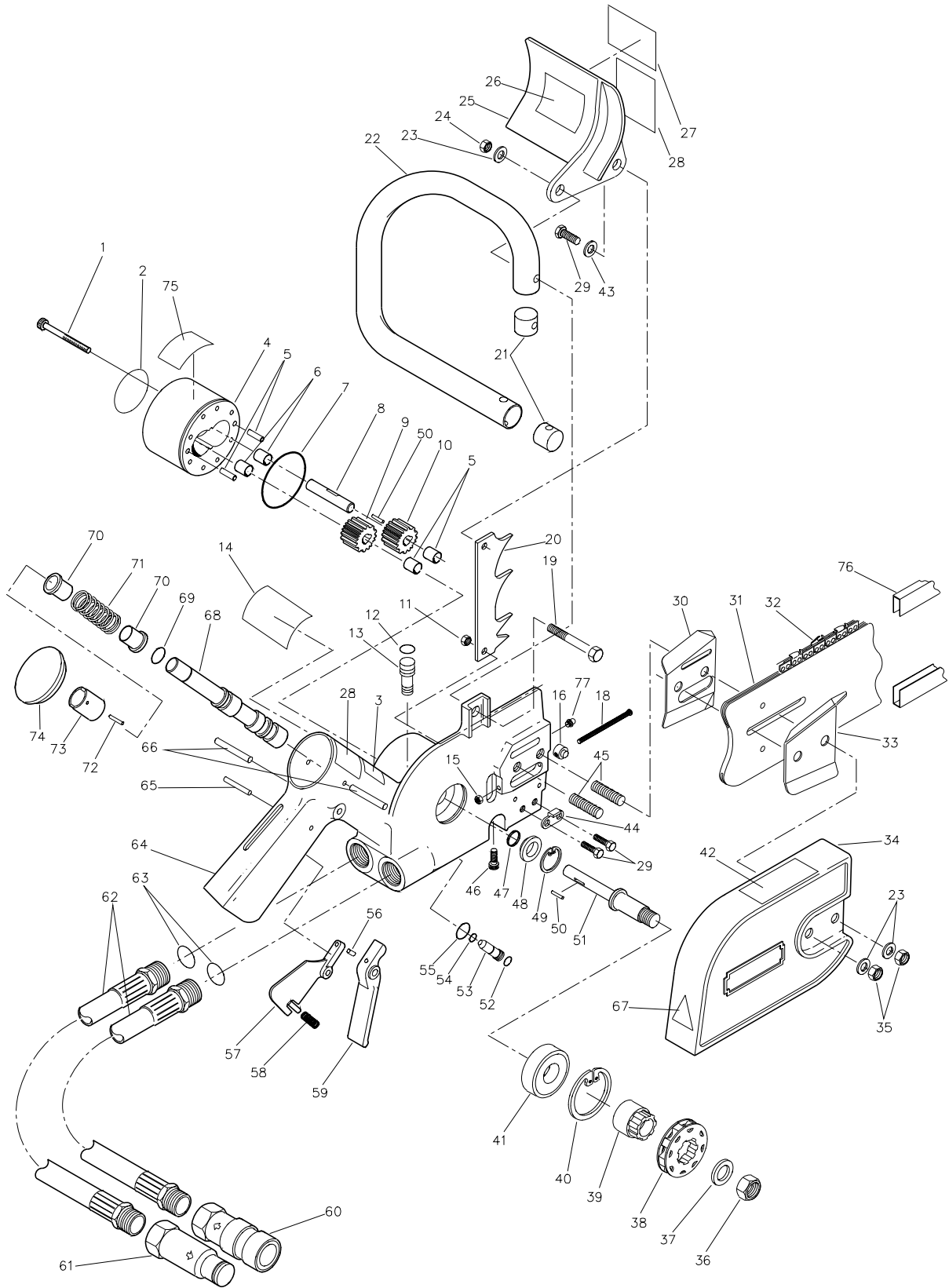

CS05/CS06 PARTS LIST

ITEM NO.	PART NO.	QTY	DESCRIPTION
1	00753 09622	8	CAPSCREW CAPSCREW U/W MODEL
2	07636 08202	1	NAME TAG—CS06 NAME TAG—CS05
3	28323	1	CE DECAL (CE ONLY)
4	07652	1	REAR GEAR HSG ASSY (7–9 GPM)
	07834	1	REAR GEAR HSG ASSY (4–6 GPM)
5	00289	2	DOWEL PIN
6	04041	4	BUSHING
7	00020	1	O-RING
8	07612	1	IDLER SHAFT
9	04106 07832	2	DRIVE GEAR (7–9 GPM) DRIVE GEAR (4–6 GPM)
10	—	—	NO ITEM
11	00038 00788	1	NUT NUT U/W MODEL
12	01362	1	O-RING
13	02921	1	AUTOMATIC OILER
14	17784	1	SOUND POWER LEVEL. DECAL (CE ONLY)
15	06971 07724	1	LOCKNUT LOCKNUT U/W MODEL
16	07620 07714	1	BAR ADJUSTMENT NUT BAR ADJUSTMENT NUT U/W MODEL
17	11354	1	OC/CC DECAL (NOT ILLUSTRATED)
18	07632 07723	1	SCREW SCREW U/W MODEL
19	00144 00230	1	CAPSCREW CAPSCREW U/W MODEL
20	01116	1	BUCKING CLEAT
21	02649	2	HANDLE BAR RETAINER
22	07611	1	HANDLE BAR
23	02634	3	WASHER
24	00429 09277	1	NUT NUT U/W MODEL
25	07473	1	HAND GUARD
26	13907	1	WARNING DECAL (KICKBACK)
27	12412	1	WARNING DECAL (ELECTRIC)
28	28409	1	COMPOSITE SAFETY DECAL (CE ONLY)
29	07628 02446	3	CAPSCREW CAPSCREW U/W MODEL
30	66577	1	CHAIN GUIDE PLATE-INSIDE
31	08347	1	SAW BAR 12 IN.
	07638	1	SAW BAR 15 IN.
	07639	1	SAW BAR 20 IN.
32	08348	1	SAW CHAIN – 12 IN.
	07641	1	SAW CHAIN – 15 IN.
	07642	1	SAW CHAIN – 20 IN.

ITEM NO.	PART NO.	QTY	DESCRIPTION
33	66578	1	CHAIN GUIDE PLATE-OUTSIDE
34	07618	1	CHAIN GUARD
35	07631 07722	2	NUT NUT U/W MODEL
36	00453 00808	1	NUT NUT U/W MODEL
37	07617	1	WASHER
38	07629	1	RIM SPROCKET
39	07616	1	SPROCKET ADAPTER
40	06635	1	RET RING
41	00335 07720	1	BALL BEARING BALL BEARING U/W MODEL
42	04746	1	AUTOMATIC OILER DECAL
43	04539	1	WASHER
44	07623	1	CHAIN CATCHER
45	07630	2	STUD
46	02688 02764	1	CAPSCREW CAPSCREW U/W MODEL
47	04037	1	SHAFT SEAL
48	07615	1	SEAL BACK-UP WASHER
49	04856	1	RETAINING RING
50	04044	2	NEEDLE ROLLER
51	07613 07710	1	DRIVE SHAFT DRIVE SHAFT U/W MODEL
52	16070	1	RETAINING RING
53	10536	1	SELECTOR SCREW
54	00026	1	O-RING
55	07627	1	O-RING
56	00072 00875	1	ROLL PIN ROLL PIN U/W MODEL
57	07603	1	SAFETY CATCH
58	07602 07715	1	SPRING SPRING U/W MODEL
59	34093	1	TRIGGER CASTING
60	03972	1	COUPLER, FEMALE
61	03973	1	COUPLER, MALE
62	28234	2	HOSE
63	01605	2	O-RING
64	07693 07713	1	VALVE HANDLE ASSY VALVE HANDLE ASSY U/W MODEL
65	07624 07718	1	ROLL PIN ROLL PIN U/W MODEL
66	03009 03278	2	ROLL PIN ROLL PIN U/W MODEL
67	11207	1	CIRCUIT TYPE D DECAL (CE ONLY)
68	10535	1	ON/OFF VALVE SPOOL
69	07626	1	O-RING
70	07609	2	SPRING WASHER

PARTS LIST

ITEM NO.	PART NO.	QTY	DESCRIPTION
71	07610	1	SPRING
72	00190	1	ROLL PIN
73	10537	1	KEEPER
74	07625	1	PLUG BUTTON
75	03786	1	GPM STICKER (7-9 GPM)
	03782	1	GPM STICKER (4-6 GPM)
76	05144	1	BAR & CHAIN GUARD
77	00767	1	GREASE FITTING U/W MODEL ONLY
	00936	2	ADAPTER (NOT SHOWN)
	26414	1	LOCK OUT KIT, SHIPPED INSTALLED (NOT SHOWN)
	03971	1	COUPLER SET
	07830	1	SEAL KIT



Stanley Hydraulic Tools
3810 SE Naef Road
Milwaukie, Oregon 97267-5698 USA
(503) 659-5660 / Fax (503) 652-1780
www.stanleyhydraulic.com

IMPORTANT

To fill out a Product Warranty Recording form, and for information on your warranty, visit Stanleyhydraulic.com and select the Warranty tab.
(NOTE: The warranty recording form must be submitted to validate the warranty).

Free Manuals Download Website

<http://myh66.com>

<http://usermanuals.us>

<http://www.somanuals.com>

<http://www.4manuals.cc>

<http://www.manual-lib.com>

<http://www.404manual.com>

<http://www.luxmanual.com>

<http://aubethermostatmanual.com>

Golf course search by state

<http://golfingnear.com>

Email search by domain

<http://emailbydomain.com>

Auto manuals search

<http://auto.somanuals.com>

TV manuals search

<http://tv.somanuals.com>