



# CR27

## HYDRAULIC CIRCULAR SAW



### SAFETY, OPERATION AND MAINTENANCE USER MANUAL



© 2011 Stanley Black & Decker, Inc.  
New Britain, CT 06053  
U.S.A.  
30673 6/2012 Ver. 6



# TABLE OF CONTENTS

SAFETY SYMBOLS .....	4
SAFETY PRECAUTIONS .....	5
ELECTRICAL HAZARDS .....	7
TOOL STICKERS & TAGS .....	10
HOSE TYPES .....	11
HOSE RECOMMENDATIONS .....	12
FIGURE 1. TYPICAL HOSE CONNECTIONS .....	12
HTMA REQUIREMENTS .....	13
OPERATION .....	14
FIGURE 2. CORRECT ROTATION DIRECTION .....	15
FIGURE 3. COLLET NUT & LOCKING NUT .....	15
FIGURE 4. FLUSH CUTTING A LIMB THAT MIGHT SPLIT OR TEAR. ....	16
FIGURE 5. FLUSH CUT .....	16
FIGURE 6. BLADE SHARPENING .....	17
FIGURE 7. FILING ANGLE .....	17
FIGURE 8. SETTING CUTTER TOOTH ANGLE .....	18
TOOL PROTECTION & CARE .....	19
TROUBLESHOOTING .....	20
SPECIFICATIONS .....	21
ACCESSORIES .....	21
CR27 PARTS ILLUSTRATION .....	22
CR27 PARTS LIST .....	23

## IMPORTANT

To fill out a Product Warranty Recording form, and for information on your warranty, visit [Stanleyhydraulic.com](http://Stanleyhydraulic.com) and select the Warranty tab.  
**(NOTE:** The warranty recording form must be submitted to validate the warranty).

**SERVICING:** This manual contains safety, operation, and routine maintenance instructions. Stanley Hydraulic Tools recommends that servicing of hydraulic tools, other than routine maintenance, must be performed by an authorized and certified dealer. Please read the following warning.

## ⚠ WARNING

**SERIOUS INJURY OR DEATH COULD RESULT FROM THE IMPROPER REPAIR OR SERVICE OF THIS TOOL.**

**REPAIRS AND / OR SERVICE TO THIS TOOL MUST ONLY BE DONE BY AN AUTHORIZED AND CERTIFIED DEALER.**

For the nearest authorized and certified dealer, call Stanley Hydraulic Tools at the number listed on the back of this manual and ask for a Customer Service Representative.

# SAFETY SYMBOLS

Safety symbols and signal words, as shown below, are used to emphasize all operator, maintenance and repair actions which, if not strictly followed, could result in a life-threatening situation, bodily injury or damage to equipment.



This is the safety alert symbol. It is used to alert you to potential personal injury hazards. Obey all safety messages that follow this symbol to avoid possible injury or death.



This safety alert and signal word indicate an imminently hazardous situation which, if not avoided, will result in death or serious injury.



This safety alert and signal word indicate a potentially hazardous situation which, if not avoided, could result in death or serious injury.



This safety alert and signal word indicate a potentially hazardous situation which, if not avoided, could result in death or serious injury.



This signal word indicates a potentially hazardous situation which, if not avoided, may result in property damage.



This signal word indicates a situation which, if not avoided, will result in damage to the equipment.



This signal word indicates a situation which, if not avoided, may result in damage to the equipment.

Always observe safety symbols. They are included for your safety and for the protection of the tool.

## LOCAL SAFETY REGULATIONS

Enter any local safety regulations here. Keep these instructions in an area accessible to the operator and maintenance personnel.

---



---



---



---



---



---



---



---



---



---



---

# SAFETY PRECAUTIONS

Tool operators and maintenance personnel must always comply with the safety precautions given in this manual and on the stickers and tags attached to the tool and hose.

These safety precautions are given for your safety. Review them carefully before operating the tool and before performing general maintenance or repairs.

Supervising personnel should develop additional precautions relating to the specific work area and local safety regulations. If so, place the added precautions in the space provided in this manual.

The CR27 Hydraulic Circular Saw will provide safe and dependable service if operated in accordance with the instructions given in this manual. Read and understand this manual and any stickers and tags attached to the tool and hoses before operation. Failure to do so could result in personal injury or equipment damage.



- Operator must start in a work area without bystanders. The operator must be familiar with all prohibited work areas such as excessive slopes and dangerous terrain conditions.
- Establish a training program for all operators to ensure safe operation.
- Do not operate the tool unless thoroughly trained or under the supervision of an instructor.
- Always wear safety equipment such as goggles, ear, head protection, and safety shoes at all times when operating the tool.
- Do not overreach. Maintain proper footing and balance at all times.
- Do not inspect or clean the tool while the hydraulic power source is connected. Accidental engagement of the tool can cause serious injury.
- Supply hoses must have a minimum working pressure rating of 2500 psi/175 bar.
- Be sure all hose connections are tight.
- The hydraulic circuit control valve must be in the **OFF** position when coupling or uncoupling the tool. Wipe all couplers clean before connecting. Use only lint-free cloths. Failure to do so may result in damage to the quick couplers and cause overheating of the hydraulic system.
- Do not operate a damaged, improperly adjusted, or incompletely assembled tool.
- Do not operate the tool at oil temperatures above 140 °F/60 °C. Operation at higher oil temperatures can cause operator discomfort and may damage the tool.
- To avoid personal injury or equipment damage, all tool repair, maintenance and service must only be performed by authorized and properly trained personnel.
- Do not exceed the rated limits of the tool or use the tool for applications beyond its design capacity.
- Always keep critical tool markings, such as labels and warning stickers legible.
- Always replace parts with replacement parts recommended by Stanley Hydraulic Tools.
- Check fastener tightness often and before each use daily.
- Do not wear loose fitting clothing when operating the tool.
- Keep all parts of your body away from the rotating saw blade.
- Keep the saw blade off all surfaces when starting the circle saw.
- Do not reverse saw blade rotation direction by changing fluid flow direction.
- Without the use of non-conductive accessories, this tool is not for use near energized electric lines. Failure to comply with this warning could result in serious personal injury.
- Never cock, jam or wedge the saw blade during operation.
- Eye injury and cutting or severing of body parts is possible if proper procedures are not followed.

## CIRCULAR SAW SPECIFIC SAFETY PRECAUTIONS

- Do not rely exclusively upon the safety devices built into the saw. As a circle saw user, several steps must be taken to keep your cutting jobs free from accident or injury.
- Ensure the saw blade is correctly mounted and tightened before each use.
- Keep a good firm grip on the pole saw with both hands. Place your right hand on the rear handle and your left hand on the outer tube assembly when operating. Use a firm grip with your thumbs and fingers encircling the saw handle and outer tube assembly. A firm grip helps keep control of the saw. Do not let go.

# SAFETY PRECAUTIONS

- Ensure that the direction of rotation of the saw blade is as prescribed in this manual.
- Cut at the rated operating speeds (gpm).
- Operate the saw at “no load” for 30 seconds in a safe position and ensure there is no excessive vibration or other defects detected. If considerable vibration or other defects are detected, stop operation of the tool immediately and determine the cause. Do not use the tool until the defect is corrected.
- If the tool is dropped with a saw blade installed, the saw blade should be examined.
- Make sure you’re well rested and mentally alert before operating the saw.
- Do not start cutting until you have a clear work area, secure footing and a planned drop area for falling branches.
- Keep all parts of the body away from the saw during operation.
- Carry the saw with the unit de-energized.
- Do not operate a pole saw that is damaged, improperly adjusted or not completely and securely assembled. Make sure the saw blade stops moving when the control trigger is released.
- Use extreme caution when cutting small branches. Twigs may catch the saw blade and be whipped toward the operator or pull the operator off balance.
- Only use saw blades manufactured by Stanley Hydraulic Tools. Stanley assumes no responsibility for failure in equipment, accidental damage or accidental injury as a result of the use of saw blades not manufactured by Stanley Hydraulic Tools.
- Always assure the saw blade is sharp. Do not try to use the tool with a dull saw blade.
- Keep the handle dry, clean and free of hydraulic fluid.
- When using tools near energized transmission lines, make sure to use only hoses labeled and certified non-conductive.
- Turn off the power unit or move the hydraulic control valve to neutral before setting the pole saw down.
- Know the location of buried or covered electrical services before starting work.
- To avoid personal injury or equipment damage, all tool repair, maintenance and service must only be performed by authorized and properly trained personnel.

The following guidelines must be followed to prevent accidental contact with overhead electrical conductors and/or communication wires and cables. (Ref. ANSI Z133.1-1982)

All overhead conductors and all communications wires and cables are considered to be energized with potentially fatal voltages and must never be touched either directly or indirectly. Accidental contact with any overhead conductors or communication wires and cables can result in death or serious injury.

A close inspection shall be made by the tool operator and by the tool operator's supervisor to determine whether an electrical conductor passes through the tree or passes within reaching distance of the tool operator.

Only qualified tool operators shall be assigned to the work if an electrical hazard exists.

A second qualified tool operator must be within normal voice communication during line clearing operations aloft when the tool operator approaches closer than 10 feet (3 m) to any conductor or electrical apparatus energized in excess of 750 volts, or when roping is required to remove the branches or limbs.

Tool operators must maintain the following clearances from energized conductors:

Voltage Range (phase-to-phase) (kV)	Minimum Working Distance
2.1–15.0	2 ft 0 in./0.6 m
15.1–35.0	2 ft 4 in./0.7 m
35.1–46.0	2 ft 6 in./0.75 m
46.1–72.5	3 ft 0 in./0.9 m
72.6–121.0	3 ft 4 in./1.0 m
138.0–145.0	3 ft 6 in./1.05 m
161.0–169.0	3 ft 8 in./1.1 m
230.0–242.0	5 ft 0 in./1.5 m
345.0–362.0	7 ft 0 in./2.1 m
500.0–552.0	11 ft 0 in./3.35 m
700.0–765.0	15 ft 0 in./4.55 m

All other tree workers must maintain a minimum clearance of 10 feet (3 meters) from energized conductors rated 50 kV phase-to-phase or less. Conductors rated over 50 kV phase-to-phase require a minimum clearance of 10 feet plus 4/10 of an inch (3 meters plus 10 mm) for each kilovolt over 50 kV.

When a lifting device contacts an electrical conductor, the truck supporting the device is considered to be energized and contact with the truck must be avoided except when emergency rescue procedures are being carried out. Emergency rescue should only be attempted by properly trained personnel familiar with electrical hazards.

Storm work and emergency conditions create special hazards. During these conditions, only authorized tool operators shall perform any tree operation. The following guidelines must be followed to prevent accidental contact with overhead electrical conductors and/or communication wires and cables. (Ref. ANSI Z133.1-2000)

### Working in Proximity to Electrical Hazards:

An inspection shall be made by a qualified arborist to determine whether an electrical hazard exists before climbing, or otherwise entering, or performing work in or on a tree.

Only qualified line-clearance arborists or qualified line-clearance arborist trainees shall be assigned to work where an electrical hazard exists. Qualified line-clearance arborist trainees shall be under the direct supervision of qualified line-clearance arborist.

A second qualified line-clearance arborists or line-clearance arborist trainees shall be within vision or voice communication during line-clearing operations aloft when line-clearance arborists or line-clearance arborist trainees must approach closer than 10 feet (3.05 meters) to any energized electrical conductor in excess of 750 volts (primary conductor) or when:

1. Branches or limbs being removed cannot first be cut (with a pole pruner/pole saw) to sufficiently clear electrical conductors, so as to avoid contact.
2. Roping is required to remove branches or limbs from such electrical conductors. This does not apply to individuals working on behalf of, or employed by, electrical system owners/operators engaged in line-clearing operations incidental to their normal occupation.

Qualified line-clearance arborists and line-clearance arborist trainees shall maintain minimum approach distances from energized electrical conductors in accordance with Table 1.

All other arborists shall maintain a minimum approach distance from energized electrical conductors in accordance with Table 2.

Branches hanging on an energized electrical conductor shall be removed using non-conductive equipment.

# ELECTRICAL HAZARDS

**Table 1. Minimum approach distances from energized conductors for qualified line-clearance arborists and qualified line-clearance arborist trainees.**

Nominal Voltage kV phase-to-phase	Includes 1910.269 elevation factor, sea level to 5000 ft <sup>1)</sup>		Includes 1910.269 elevation factor, 5001–10,000 ft <sup>1)</sup>		Includes 1910.269 elevation factor, 10,000–14,000 ft <sup>1)</sup>	
	ft-in	m	ft-in	m	ft-in	m
0.05–1.0	Avoid contact		Avoid contact		Avoid contact	
1.1–15.0	2-04	0.71	2-08	0.81	2-10	0.86
15.1–36.0	2-09	0.84	3-02	0.97	3-05	1.04
36.1–46.0	3-00	0.92	3-05	1.04	3-09	1.14
46.1–72.5	3-09	1.14	4-03	1.30	4-07	1.40
72.6–121.0	4-06	1.37	5-02	1.58	5-07	1.70
138.0–145.0	5-02	1.58	5-11	1.80	6-05	1.96
161.0–169.0	6-00	1.83	6-10	2.08	7-05	2.26
230.0–242.0	7-11	2.41	9-00	2.75	9-09	2.97
345.0–362.0	13-02	4.02	15-00	4.58	16-03	4.96
500.0–550.0	19-00	5.80	21-09	6.63	23-06	7.17
765.0–800.0	27-04	8.34	31-03	9.53	33-10	10.32
<sup>1)</sup> Exceeds phase-to-ground; elevation factor per 29 CFR 1910.269.						

**Table 2. Minimum approach distances to energized conductors for persons other than qualified line-clearance arborists and qualified line-clearance arborist trainees.**

Nominal Voltage kV phase-to-phase <sup>1)</sup>	Distance	
	ft-in	m
0.0–1.0	10-00	3.05
1.1–15.0	10-00	3.05
15.1–36.0	10-00	3.05
36.1–50.0	10-00	3.05
50.1–72.5	10-09	3.28
72.6–121.0	12-04	3.76
138.0–145.0	13-02	4.00
161.0–169.0	14-00	4.24
230.0–242.0	16-05	4.97
345.0–362.0	20-05	6.17
500.0–550.0	26-08	8.05
785.0–800.0	35-00	10.55
<sup>1)</sup> Exceeds phase-to-ground.		



The tie-in position should be above the work area and located in such a way that a slip would swing the arborist away from any energized electrical conductors or other identified hazard.

While climbing, the arborist should climb on the side of the tree that is away from energized electrical conductors as required in Tables 1 and 2.

Footwear, including lineman's overshoes, having electrical-resistant soles, shall not be considered as providing any measure of safety from electrical hazards.

Rubber gloves, with or without leather or other protective covering, shall not be considered as providing any measure of safety from electrical hazards.

Ladders, platforms and aerial devices, including insulated aerial devices, shall be subject to minimum approach distances in Table 1 and 2.

Aerial devices and attached equipment (such as chip-pers) contacting energized electrical conductors shall be considered energized. Contact shall be avoided, except where emergency rescue procedures are being carried out. Emergency rescue should be performed in accordance with 4.3.

## **STORM WORK AND EMERGENCY CONDITIONS-LINE CLEARANCE**

Line clearance shall not be performed during adverse weather conditions such as thunderstorms, high winds and snow and ice storms.

Qualified line-clearance arborists and qualified line-clearance arborists trainees performing line clearance in the aftermath of a storm or under similar conditions shall be trained in the special hazards associated with this type of work.

Line-clearance operations shall be suspended when storm work or emergency conditions develop involving energized electrical conductors. Electrical system owners/operators shall be notified immediately.

# TOOL STICKERS & TAGS

## DANGER

THIS SAW BLADE OF THE CR27 WILL CONTINUE TO ROTATE FOR UP TO 15 SECONDS OR MORE AFTER RELEASING THE ON/OFF TRIGGER. DURING THIS "COAST DOWN" TIME, CONTACT WITH THE BLADE OF THE CR27 MAY RESULT IN SEVERE PERSONAL INJURY.

AFTER RELEASING THE ON/OFF TRIGGER, SAW OPERATORS MUST BE CERTAIN THAT THE BLADE HAS COME TO A COMPLETE STOP BEFORE PLACING THE SAW ON THE GROUND, LOWERING THE SAW INTO THE TRUCKS BUCKET, STORING THE SAW OR CONTACTING THE BLADE IN ANY WAY. FAILURE TO OBSERVE THESE PRECAUTIONS MAY RESULT IN SEVERE PERSONAL INJURY.

OTHER WORKERS AND BYSTANDERS MUST STAY CLEAR OF THE WORK AREA TO AVOID SEVERE PERSONAL INJURY RESULTING FROM CONTACT WITH THE SAW BLADE AS WELL AS FALLING LIMBS, BRANCHES AND OTHER DEBRIS.

27694  
Danger Decal

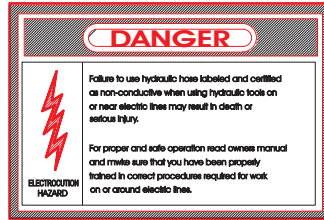

12412  
Electrical Warning Decal

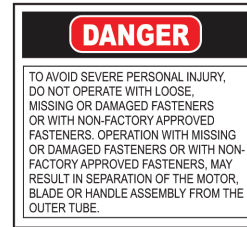

15863  
Danger Decal

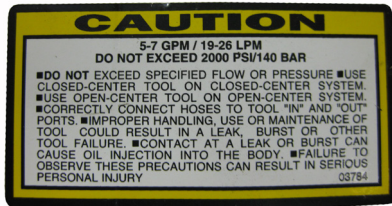

03784  
5-7 GPM Sticker



05153  
Stanley Decal

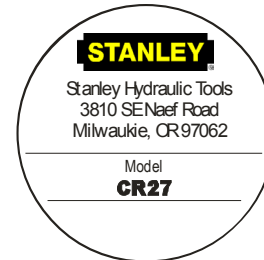

24827  
Name Tag

## DANGER

- FAILURE TO USE HYDRAULIC HOSE LABELED AND CERTIFIED AS NON-CONDUCTIVE WHEN USING HYDRAULIC TOOLS ON OR NEAR ELECTRICAL LINES MAY RESULT IN DEATH OR SERIOUS INJURY.  
BEFORE USING HOSE LABELED AND CERTIFIED AS NON-CONDUCTIVE ON OR NEAR ELECTRICAL LINES BE SURE THE HOSE IS MAINTAINED AS NON-CONDUCTIVE. THE HOSE SHOULD BE REGULARLY TESTED FOR ELECTRIC CURRENT LEAKAGE IN ACCORDANCE WITH YOUR SAFETY DEPARTMENT INSTRUCTIONS.
- A HYDRAULIC LEAK OR BURST MAY CAUSE OIL INJECTION INTO THE BODY OR CAUSE OTHER SEVERE PERSONAL INJURY.
  - DO NOT EXCEED SPECIFIED FLOW AND PRESSURE FOR THIS TOOL. EXCESS FLOW OR PRESSURE MAY CAUSE A LEAK OR BURST.
  - DO NOT EXCEED RATED WORKING PRESSURE OF HYDRAULIC HOSE USED WITH THIS TOOL. EXCESS PRESSURE MAY CAUSE A LEAK OR BURST.
  - CHECK TOOL HOSE COUPLERS AND CONNECTORS DAILY FOR LEAKS. DO NOT FEEL FOR LEAKS WITH YOUR HANDS. CONTACT WITH A LEAK MAY RESULT IN SEVERE PERSONAL INJURY.

## IMPORTANT

READ OPERATION MANUAL AND SAFETY INSTRUCTIONS FOR THIS TOOL BEFORE USING IT.

USE ONLY PARTS AND REPAIR PROCEDURES APPROVED BY STANLEY AND DESCRIBED IN THE OPERATION MANUAL.

TAG TO BE REMOVED ONLY BY TOOL OPERATOR.

SEE OTHER SIDE

## DANGER

- DO NOT LIFT OR CARRY TOOL BY THE HOSES. DO NOT ABUSE HOSE. DO NOT USE KINKED, TORN OR DAMAGED HOSE.
- MAKE SURE HYDRAULIC HOSES ARE PROPERLY CONNECTED TO THE TOOL BEFORE PRESSURING SYSTEM. SYSTEM PRESSURE HOSE MUST ALWAYS BE CONNECTED TO TOOL "IN" PORT. SYSTEM RETURN HOSE MUST ALWAYS BE CONNECTED TO TOOL "OUT" PORT. REVERSING CONNECTIONS MAY CAUSE REVERSE TOOL OPERATION WHICH CAN RESULT IN SEVERE PERSONAL INJURY.
- DO NOT CONNECT OPEN-CENTER TOOLS TO CLOSED-CENTER HYDRAULIC SYSTEMS. THIS MAY RESULT IN LOSS OF OTHER HYDRAULIC FUNCTIONS POWERED BY THE SAME SYSTEM AND/OR SEVERE PERSONAL INJURY.
- BYSTANDERS MAY BE INJURED IN YOUR WORK AREA. KEEP BYSTANDERS CLEAR OF YOUR WORK AREA.
- WEAR HEARING, EYE, FOOT, HAND AND HEAD PROTECTION.
- TO AVOID PERSONAL INJURY OR EQUIPMENT DAMAGE, ALL TOOL REPAIR MAINTENANCE AND SERVICE MUST ONLY BE PERFORMED BY AUTHORIZED AND PROPERLY TRAINED PERSONNEL.

## IMPORTANT

READ OPERATION MANUAL AND SAFETY INSTRUCTIONS FOR THIS TOOL BEFORE USING IT.

USE ONLY PARTS AND REPAIR PROCEDURES APPROVED BY STANLEY AND DESCRIBED IN THE OPERATION MANUAL.

TAG TO BE REMOVED ONLY BY TOOL OPERATOR.

SEE OTHER SIDE

SAFETY TAG P/N 15875 (Shown smaller than actual size)

The rated working pressure of the hydraulic hose must be equal to or higher than the relief valve setting on the hydraulic system. There are three types of hydraulic hose that meet this requirement and are authorized for use with Stanley Hydraulic Tools. They are:

**Certified non-conductive** — constructed of thermoplastic or synthetic rubber inner tube, synthetic fiber braid reinforcement, and weather resistant thermoplastic or synthetic rubber cover. *Hose labeled **certified non-conductive** is the only hose authorized for use near electrical conductors.*

**Wire-braided** (conductive) — constructed of synthetic rubber inner tube, single or double wire braid reinforcement, and weather resistant synthetic rubber cover. *This hose is **conductive** and must never be used near electrical conductors.*

**Fabric-braided** (not certified or labeled non-conductive) — constructed of thermoplastic or synthetic rubber inner tube, synthetic fiber braid reinforcement, and weather resistant thermoplastic or synthetic rubber cover. *This hose is **not certified non-conductive** and must never be used near electrical conductors.*

## HOSE SAFETY TAGS

To help ensure your safety, the following DANGER tags are attached to all hose purchased from Stanley Hydraulic Tools. **DO NOT REMOVE THESE TAGS.**

If the information on a tag is illegible because of wear or damage, replace the tag immediately. A new tag may be obtained from your Stanley Distributor.

### THE TAG SHOWN BELOW IS ATTACHED TO “CERTIFIED NON-CONDUCTIVE” HOSE

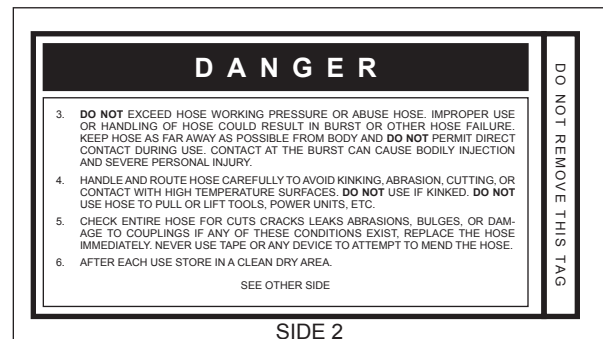
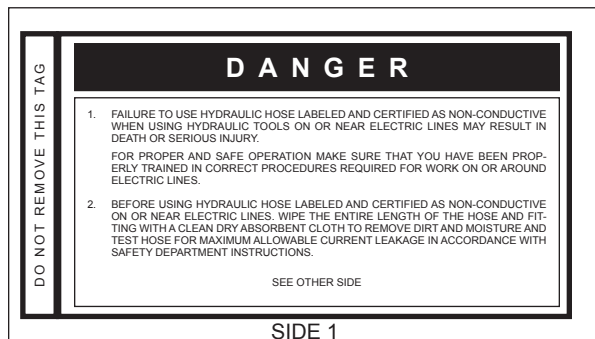

(Shown smaller than actual size)

### THE TAG SHOWN BELOW IS ATTACHED TO “CONDUCTIVE” HOSE.

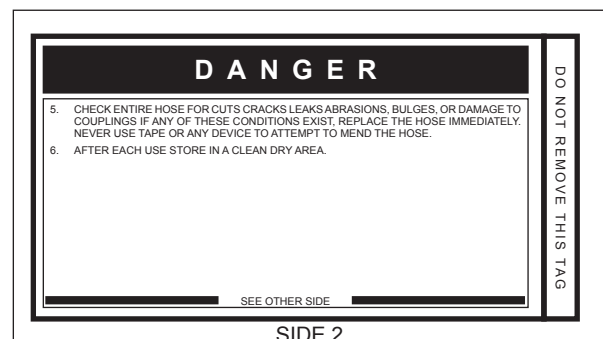
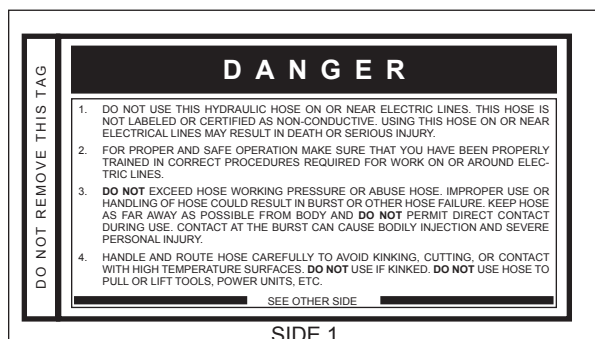

(Shown smaller than actual size)

# HOSE RECOMMENDATIONS

## Tool to Hydraulic Circuit Hose Recommendations

The chart to the right shows recommended minimum hose diameters for various hose lengths based on gallons per minute (gpm)/liters per minute (lpm). These recommendations are intended to keep return line pressure (back pressure) to a minimum acceptable level to ensure maximum tool performance.

This chart is intended to be used for hydraulic tool applications only based on Stanley Hydraulic Tools tool operating requirements and should not be used for any other applications.

All hydraulic hose must have at least a rated minimum working pressure equal to the maximum hydraulic system relief valve setting.

**All hydraulic hose must meet or exceed specifications as set forth by SAE J517.**

Oil Flow		Hose Lengths		Inside Diameter		USE (Press/Return)	Min. Working Pressure	
GPM	LPM	FEET	METERS	INCH	MM		PSI	BAR
<b>Certified Non-Conductive Hose - Fiber Braid - for Utility Bucket Trucks</b>								
4-9	15-34	up to 10	up to 3	3/8	10	Both	2250	155
<b>Conductive Hose - Wire Braid or Fiber Braid - DO NOT USE NEAR ELECTRICAL CONDUCTORS</b>								
4-6	15-23	up to 25	up to 7.5	3/8	10	Both	2500	175
4-6	15-23	26-100	7.5-30	1/2	13	Both	2500	175
5-10.5	19-40	up to 50	up to 15	1/2	13	Both	2500	175
5-10.5	19-40	51-100	15-30	5/8	16	Both	2500	175
5-10.5	19-40	100-300	30-90	5/8	16	Pressure	2500	175
10-13	38-49	up to 50	up to 15	3/4	19	Return	2500	175
10-13	38-49	51-100	15-30	5/8	16	Both	2500	175
10-13	38-49	100-200	30-60	3/4	19	Pressure	2500	175
13-16	49-60	up to 25	up to 8	5/8	16	Return	2500	175
13-16	49-60	26-100	8-30	3/4	19	Pressure	2500	175
13-16	49-60	26-100	8-30	1	25.4	Return	2500	175

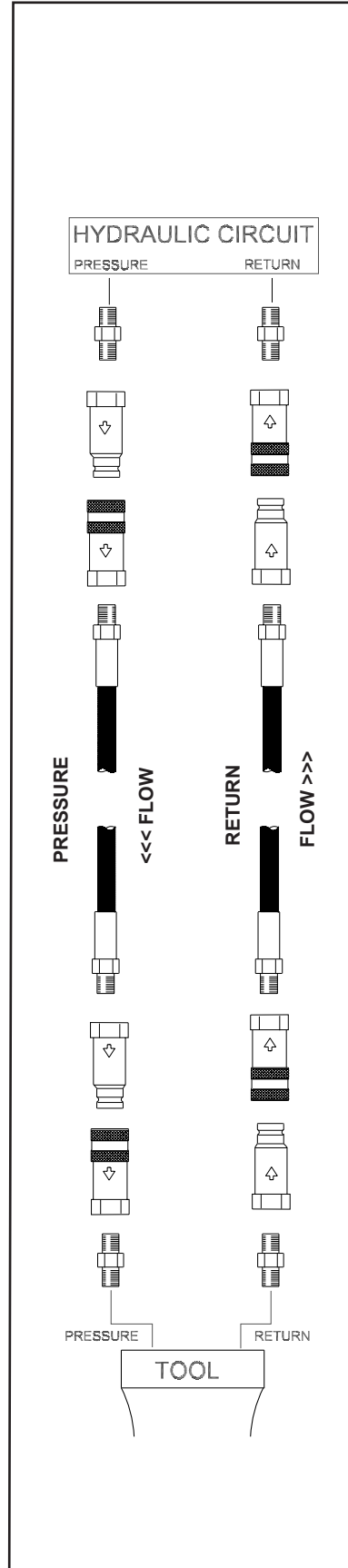

Figure 1. Typical Hose Connections

# HTMA REQUIREMENTS

## HTMA / EHTMA REQUIREMENTS

### HTMA

#### HYDRAULIC SYSTEM REQUIREMENTS

### TOOL TYPE

#### TYPE I

#### TYPE II

#### TYPE RR

#### TYPE III

Flow Range	4-6 gpm (15-23 lpm)	7-9 gpm (26-34 lpm)	9-10.5 gpm (34-40 lpm)	11-13 gpm (42-49 lpm)
Nominal Operating Pressure (at the power supply outlet)	1500 psi (103 bar)	1500 psi (103 bar)	1500 psi (103 bar)	1500 psi (103 bar)
System relief valve setting (at the power supply outlet)	2100-2250 psi (145-155 bar)	2100-2250 psi (145-155 bar)	2200-2300 psi (152-159 bar)	2100-2250 psi (145-155 bar)
Maximum back pressure (at tool end of the return hose)	250 psi (17 bar)	250 psi (17 bar)	250 psi (17 bar)	250 psi (17 bar)
Measured at a max. fluid viscosity of: (at min. operating temperature)	400 ssu* (82 centistokes)	400 ssu* (82 centistokes)	400 ssu* (82 centistokes)	400 ssu* (82 centistokes)
Temperature: Sufficient heat rejection capacity to limit max. fluid temperature to: (at max. expected ambient temperature)	140° F (60° C)	140° F (60° C)	140° F (60° C)	140° F (60° C)
Min. cooling capacity at a temperature difference of between ambient and fluid temps	3 hp (2.24 kW) 40° F (22° C)	5 hp (3.73 kW) 40° F (22° C)	6 hp (5.22 kW) 40° F (22° C)	7 hp (4.47 kW) 40° F (22° C)
<b>NOTE:</b> Do not operate the tool at oil temperatures above 140° F (60° C). Operation at higher temperatures can cause operator discomfort at the tool.				
Filter Min. full-flow filtration Sized for flow of at least: (For cold temp. startup and max. dirt-holding capacity)	25 microns 30 gpm (114 lpm)	25 microns 30 gpm (114 lpm)	25 microns 30 gpm (114 lpm)	25 microns 30 gpm (114 lpm)
Hydraulic fluid Petroleum based (premium grade, anti-wear, non-conductive) Viscosity (at min. and max. operating temps)	100-400 ssu*	100-400 ssu* (20-82 centistokes)	100-400 ssu*	100-400 ssu*
<b>NOTE:</b> When choosing hydraulic fluid, the expected oil temperature extremes that will be experienced in service determine the most suitable temperature viscosity characteristics. Hydraulic fluids with a viscosity index over 140 will meet the requirements over a wide range of operating temperatures.				
*SSU = Saybolt Seconds Universal				

### EHTMA HYDRAULIC SYSTEM REQUIREMENTS

### CLASSIFICATION



Flow Range	3.5-4.3 gpm (13.5-16.5 lpm)	4.7-5.8 gpm (18-22 lpm)	7.1-8.7 gpm (27-33 lpm)	9.5-11.6 gpm (36-44 lpm)	11.8-14.5 gpm (45-55 lpm)
Nominal Operating Pressure (at the power supply outlet)	1870 psi (129 bar)	1500 psi (103 bar)	1500 psi (103 bar)	1500 psi (103 bar)	1500 psi (103 bar)
System relief valve setting (at the power supply outlet)	2495 psi (172 bar)	2000 psi (138 bar)	2000 psi (138 bar)	2000 psi (138 bar)	2000 psi (138 bar)

**NOTE:** These are general hydraulic system requirements. See tool specification page for tool specific requirements

# OPERATION

## PREOPERATION PROCEDURES

### PREPARATION FOR INITIAL USE

Each unit as shipped has no special unpacking or assembly requirements prior to usage. Inspection to assure the unit was not damaged in shipping and does not contain packing debris is all that is required. After installation of a saw blade a unit may be put to use.

### CHECK HYDRAULIC POWER SOURCE

1. Using a calibrated flowmeter and pressure gauge, check that the hydraulic power source develops a flow of 5–7 gpm/19–26 lpm at 1000–2000 psi/70–140 bar.
2. Make certain the hydraulic power source is equipped with a relief valve set to open at 2100–2250 psi/145–155 bar minimum.
3. Check that the dual spool valve is set to the hydraulic system type (open-center (OC) or closed-center (CC) operation).

### CHECK TOOL

1. Make sure all tool accessories are correctly installed. Failure to install tool accessories properly can result in damage to the tool or personal injury.
2. There should be no signs of leaks.
3. The tool should be clean, with all fittings and fasteners tight.

### CHECK TRIGGER MECHANISM

Check that the trigger operates smoothly and is free to travel between the **ON** and **OFF** positions.

## SETTING THE DUAL SPOOL FOR OC (OPEN-CENTER) OR CC (CLOSED-CENTER) OPERATION

### IMPORTANT

This tool is furnished with a ON/OFF spool commonly referred to as a “dual spool” which permits adjustment so the tool may be operated on either an open-center (OC) or closed-center (CC) hydraulic system. The dual spool is normally set to the OC position at time of manufacture. The dual spool can also be disabled so that the tool may be set to OC only operation. For more details, please refer to the following instructions.

## SETTING FOR OPEN-CENTER (OC) OR CLOSED-CENTER (CC) OPERATION

1. To set the tool for open-center (OC) system operation turn the selector screw located in the top of the valve spool fully out (counter-clockwise) until it hits the stop.
2. To set the tool for closed-center (CC) system operation turn the selector screw located in the top of the valve spool fully in (clockwise) until it bottoms.

## TO DISABLE DUAL SPOOL OPERATION AND CONVERT TO OPEN-CENTER ONLY OPERATION

1. Turn the selector screw located in the top of the valve spool fully out (counter-clockwise) until it hits the stop.
2. Insert the small plug from the kit (furnished with the tool) into the hole located in the top of the selector screw. Tap the plug down using a small punch and hammer. **DO NOT USE ANY ADHESIVES.**

## TO DISABLE DUAL SPOOL OPERATION AND CONVERT TO CLOSED-CENTER ONLY OPERATION

1. Turn the selector screw located in the top of the valve spool fully in (clockwise) until it bottoms.
2. Insert the small plug from the kit (furnished with the tool) into the hole located in the top of the selector screw. Tap the plug down using a small punch and hammer. **DO NOT USE ANY ADHESIVES.**

## BLADE INSTALLATION

1. Handle the saw blade with care. The cutting edges are sharp and careless handling could result in injury.
2. Install the blade over the motor shaft and onto the fixed collar so that the points of the teeth on the blade are facing clockwise as viewed from the front of the motor (see Figure 2).
3. Install the moveable collar followed by the collet nut (see Figure 3). Tighten the collet nut hard (not wrist tight).
4. Install the locking nut with internal taper facing toward the collet nut and tighten it hard against the collet nut.
5. As a final tightening procedure, with a wrench on each of the nuts, tighten the locking nut one half wrench flat further.



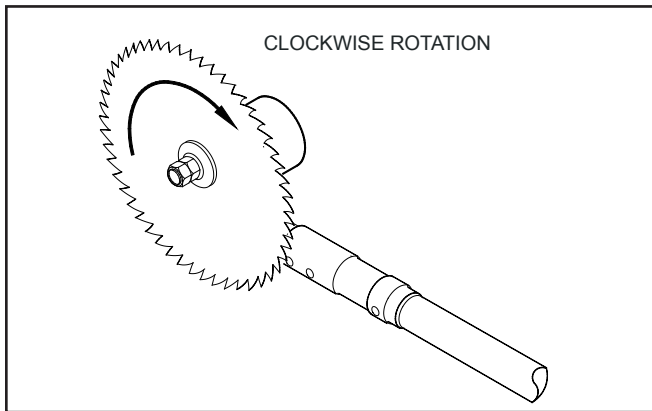

Figure 2. Correct Rotation Direction

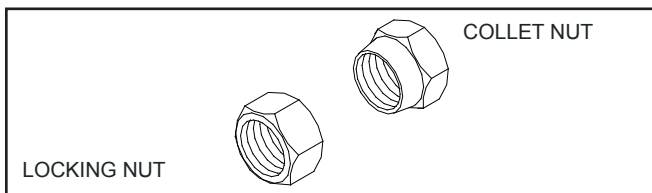

Figure 3. Collet Nut & Locking Nut

## CONNECT HOSES

1. Wipe all hose couplers with a clean lint-free cloth before making connections.
2. Connect the hoses from the hydraulic power source to the hose couplers on the saw. It is a good practice to connect the return hose first and disconnect it last to minimize or avoid trapped pressure within the saw motor.
3. Observe flow indicators stamped on hose couplers to be sure that oil will flow in the proper direction. The female coupler is the inlet coupler.

### NOTE:

**The pressure increase in uncoupled hoses left in the sun may result in making them difficult to connect. When possible, connect the free ends of operating hoses together.**

## OPERATING PROCEDURES

Observe all safety precautions.

- **DO NOT OPERATE A CIRCLE SAW UNLESS YOU HAVE BEEN SPECIFICALLY TRAINED TO DO SO.**
- Keep all parts of the body away from the saw blade during operation of the tool.
- Carry the saw with the unit de-energized and the blade away from the body.

- Always connect the hoses to the tool hose couplers before energizing the power source.
- Do not operate a circle saw that is damaged, improperly adjusted or is not completely and securely assembled.
- Keep the saw and handles clean and free of oil and contaminants.
- Do not hang the saw on utility wires or cables.
- Do not leave the saw hanging in a tree.
- Do not leave cut branches in a tree.
- Branches bent under tension are considered hazardous.
- Do not allow binding of the saw blade.
- The saw blade will continue to spin for up to 5 seconds or more after releasing the ON/OFF trigger. During this “coast down” time, contact with the saw blade may result in severe personal injury. Refer to page 2. On early model saws the “coast down” time will be up to 15 seconds.
- Use extreme caution when sawing small size brush and saplings. Slender material may catch in the saw blade and be thrown toward the operator.
- Keep the saw blade away from all surfaces when starting rotation of the blade.
- Do not reverse blade rotation direction by changing oil flow direction. The saw is designed to operate in only one direction.
- Do not use the saw around energized transmission lines.
- Do not inspect, clean or repair the saw with the power source operating or with operating pressure at the saw. Accidental engagement of the tool can cause serious injury.
- Do not operate the saw at oil temperatures above 140 °F/60 °C. Operation at higher temperatures can cause higher than normal temperatures at the tool which can cause operator discomfort.
- After releasing the ON/OFF trigger, be certain that the saw blade has come to a complete stop before placing the saw on the ground, lowering the saw into the truck’s bucket, storing the saw or contacting the blade in any way. Failure to observe these precautions may result in severe personal injury.
- The saw operator must keep other workers and bystanders clear of the work area, including the area into which cut limbs or debris fall. Failure to heed this precaution can result in severe personal injury.

# OPERATION

## MAKING CUTS

### **⚠ WARNING**

The following are general wood cutting procedures and techniques. Differences in the terrain, vegetation, and type of wood will make this information more or less valid for particular areas.

For advice on specific wood cutting problems or techniques for your area, consult your local Stanley representative or your county agent. They can often provide information that will make your work safer and more productive.

1. Move the hydraulic circuit control valve to the **ON** position to pressurize the circuit.
2. Maintain a firm grip on the saw handle. While maintaining firm footing and balance, position the saw blade near the material to be cut.
3. Squeeze the ON/OFF valve handle trigger and allow the saw blade to reach **FULL** speed.

### **IMPORTANT**

The saw blade must reach **FULL** speed before attempting a cut.

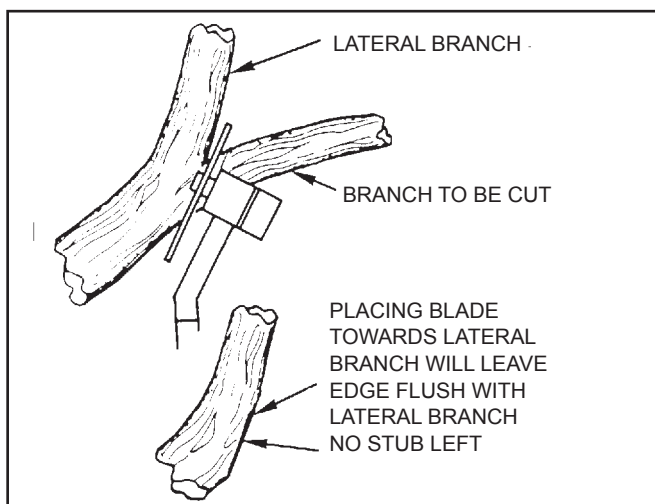

Figure 4. Flush Cutting a Limb That Might Split or Tear.

4. In sawing limbs which have a tendency to split or tear when making a single saw flush cut, Figure 4, it is advisable to make more than one cut. The first cut is made a few inches from the point of the flush cut removing the weight of the limb being trimmed out and leaving a short stub. The stub is then flushed off as shown in Figure 5. Whenever practical, the cut shall be treated with tree paint if it is larger than 1 inch in diameter. This technique will avoid breaking the lateral which you are trying to save or splitting the remaining limb down the center as the flush cut is made.

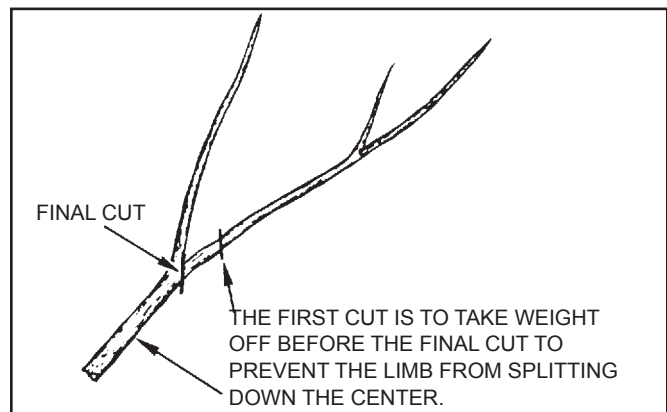

Figure 5. Flush Cut

### **⚠ WARNING**

Do not cut material that is directly overhead. When it falls it may cause operator injury.

5. Watch the saw reaction to making a cut. Control the movement of the saw.
6. Release the ON/OFF trigger to stop saw blade rotation.
7. Reposition the saw to make the next cut and continue operating the saw as stated above.

### **⚠ WARNING**

After releasing the ON/OFF trigger, saw operators must be certain that the saw has come to a complete stop after a few seconds or more. The saw blade must come to a complete stop before placing the saw into the truck's bucket, storing the saw or contacting the blade in any way. Failure to observe this warning may result in severe personal injury.



## AFTER OPERATION

1. Wipe the saw thoroughly with a clean dry or slightly oiled cloth.
2. Clean tree pitch and residue from the blade. Handle the blade with care to avoid getting cut by the sharp teeth.
3. Check all fasteners for tightness.
4. When the saw is not in use, store horizontally in a clean, dry space and protected from damage.
5. Protect the blade teeth and keep the teeth sharp. A sharp blade will cut cleaner and faster.

## BLADE CARE

Every day visually check the blade for cracks and warpage. Cracks will lead to a break and “out of flat” will cause excessive vibration. Make sure the spindle lock-nut is tight.

When sharpening, never use a flat file which may leave a square corner in the gullet. Because of high speed vibration, this becomes a point from which a crack will start.

Do not let gum, sap or dirt build up underneath the cutting edges. This adds undue friction and reduces cutting efficiency due to loss of clearance.

Inspection of the cutting teeth should be made often during each day’s use. It is faster to touch up the teeth with a few strokes of the file than to allow the teeth to get dull. Dull teeth cause loss of cutting capacity and too much friction. A sharp spare blade is a good back-up in case of trouble.

## BLADE SHARPENING

### BLADE TEETH

Using a file holder with a 7/16 inch round file (Stanley Part Number 11299), place the file holder flat on top of the cutter with the file against the cutter tooth.

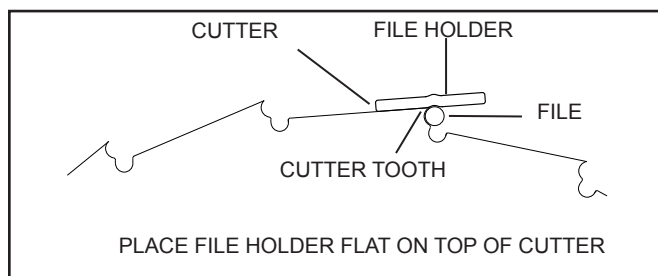

Figure 6. Blade Sharpening

Maintain a 20° angle and always file outwards on each right or left cutter tooth. File only with a slight pressure against the cutter tooth (not on top of the cutter) during the forward stroke. Release pressure as you pull the file back. The file will only cut during the forward stroke.

While filing, always try to keep the file holder perpendicular to the side of the blade. Try not to move the file holder up or down or move the file holder to the setting of the tooth.

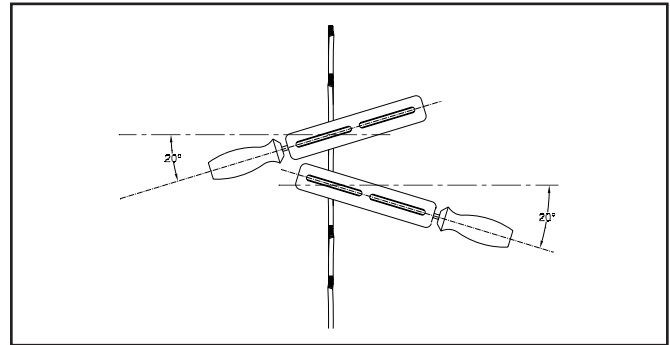

Figure 7. Filing Angle

### TOP OF CUTTERS

The top of each cutter is factory ground to ensure the best cutting performance. Normally, the tops of the cutters will not require filing unless the edge is badly worn or damaged.

If the top of a cutter requires filing, use a smooth flat file to give the cutter its original shape. After filing, ensure that all cutters have the same length and profile.

### SETTING TOOTH ANGLE

A sharp outside corner and an exact angle setting will give maximum cutting performance. Special setting tool (Stanley part number 34653) is required to verify or properly set the angle of each cutter tooth at .040 inch/1 mm.

Match one of the grooves in the setting tool to the blade thickness. Place the setting tool over the cutter near the cutter tooth and bend the tooth until the angle on the setting tool touches the side of the blade. **DO NOT OVER SET.** Over-setting will cause rough cutting and vibration which may result in stress cracks and eventual blade failure.

# OPERATION

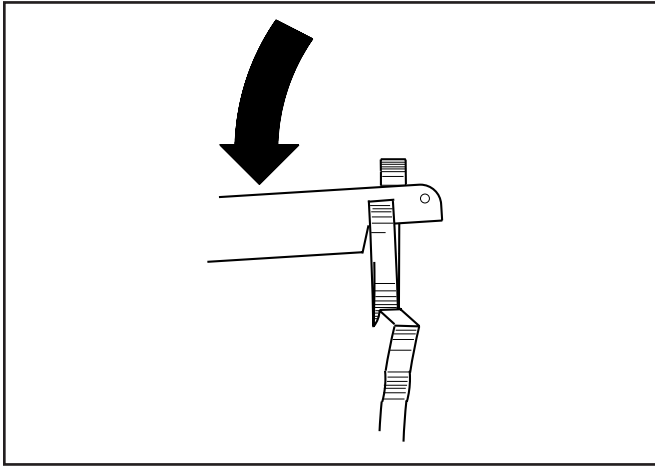

Figure 8. Setting Cutter Tooth Angle

## COLD WEATHER OPERATION

If the saw is to be used during cold weather, preheat the hydraulic fluid at low engine speed. When using the normally recommended fluids, fluid temperature should be at or above 50 °F/10 °C (400 ssu/82 centistokes) before use.

## NOTICE

In addition to the Safety Precautions found in this manual, observe the following for equipment protection and care.

- Make sure all couplers are wiped clean before connection.
- The hydraulic circuit control valve must be in the **OFF** position when coupling or uncoupling hydraulic tools. Failure to do so may result in damage to the quick couplers and cause overheating of the hydraulic system.
- Always store the tool in a clean dry space, safe from damage or pilferage.
- Make sure the circuit **PRESSURE** hose (with male quick disconnect) is connected to the **IN** port. The circuit **RETURN** hose (with female quick disconnect) is connected to the opposite port. Do not reverse circuit flow. This can cause damage to internal seals.
- Always replace hoses, couplings and other parts with replacement parts recommended by Stanley Hydraulic Tools. Supply hoses must have a minimum working pressure rating of 2500 psi/172 bar.
- Do not exceed the rated flow and pressure. Refer to the Specifications page in this manual for correct flow and pressure rates. If flow and pressure are exceeded, rapid failure of the internal seals may result.
- Always keep critical tool markings, such as warning stickers and tags legible.
- Tool repair should be performed by experienced personnel only.
- Make certain that the recommended relief valves are installed in the pressure side of the system.
- Do not use the tool for applications for which it was not intended.

# TROUBLESHOOTING

If symptoms of poor performance develop, the following chart can be used as a guide to correct the problem. When diagnosing faults in operation of the saw, always make sure the hydraulic power source is supplying the correct hydraulic flow and pressure to the saw as listed in the table. Use a flowmeter know to be accurate. Check the flow with the hydraulic fluid temperature at least 80 °F/27 °C.

PROBLEM	CAUSE	REMEDY
Tool will not operate.	Hydraulic system not engaged or running.	Engage or start hydraulic system.
	Hydraulic system control valve is <b>OFF</b> .	Turn the system control valve <b>ON</b> .
	Tool not connected to the hydraulic system.	Connect tool to the system.
Trigger and valve spool stick.	Damaged trigger guard.	Have repaired by an authorized Stanley Hydraulic Tools dealer.
	High back pressure.	Determine cause of high back pressure and return line and remove restriction.
	Tool reverse plumbed to the system.	Correctly connect the pressure and return lines.
	Valve spool or spool bore scored by contaminated hydraulic fluid.	Have repaired by an authorized Stanley Hydraulic Tools dealer.
Saw cuts poorly.	Blade is dull.	Replace with sharp blade.
	Saw is running backwards.	Check direction of rotation. Correct rotation is counterclockwise as viewed from the motor side of the saw blades.
	Blade installed backwards.	Install the blade correctly. Blade teeth point in direction of rotation, counterclockwise as viewed from the motor side of the saw blades.
Saw slows excessively under load.	System relief valve set too low.	Check system relief and adjust relief valve to crack open at 2100 psi.
	Tool motor worn.	Have inspected and repaired by an authorized Stanley Hydraulic Tools dealer.
Hydraulic oil leaks from motor shaft.	Motor shaft seal worn or failed.	Have inspected and repaired by an authorized Stanley Hydraulic Tools dealer.
Hydraulic oil leaks between valve handle and outer tube handle.	Oil tube seals worn or oil tubes worn.	Have inspected and repaired by an authorized Stanley Hydraulic Tools dealer.

# SPECIFICATIONS

Capacity.....	9 in. Diameter/23 cm Blade
Pressure Range.....	1000–2000 psi/70–140 bar
Maximum Back Pressure.....	250 psi/17 bar
Flow Range .....	5–7 gpm/19–26 lpm
Porting .....	-8 SAE O-ring
Connect Size and Type .....	3/8 in. NPT × -8 SAE Male Pipe Adapter
Hose Whips .....	No
Weight .....	9.75 lbs/4.4 kg
Overall Length .....	79 in./200 cm
Maximum Fluid Temperature .....	140 °F/60 °C

## ACCESSORIES

Description	Part No.
9 in./23 cm Saw Blade, 44 tooth.....	00425
9 in./23 cm Brushcutter Saw Blade .....	34356
File Holder with 7/32 Round File (for sharpening brushcutter blades) .....	11299
Setting Tool (for setting cutter angles on brushcutter) .....	34653
Certified Non-Conductive Dual Oil Resistant Hose, 3/8 in. Diameter × 10 ft with Guards.....	05005

# CR27 PARTS ILLUSTRATION

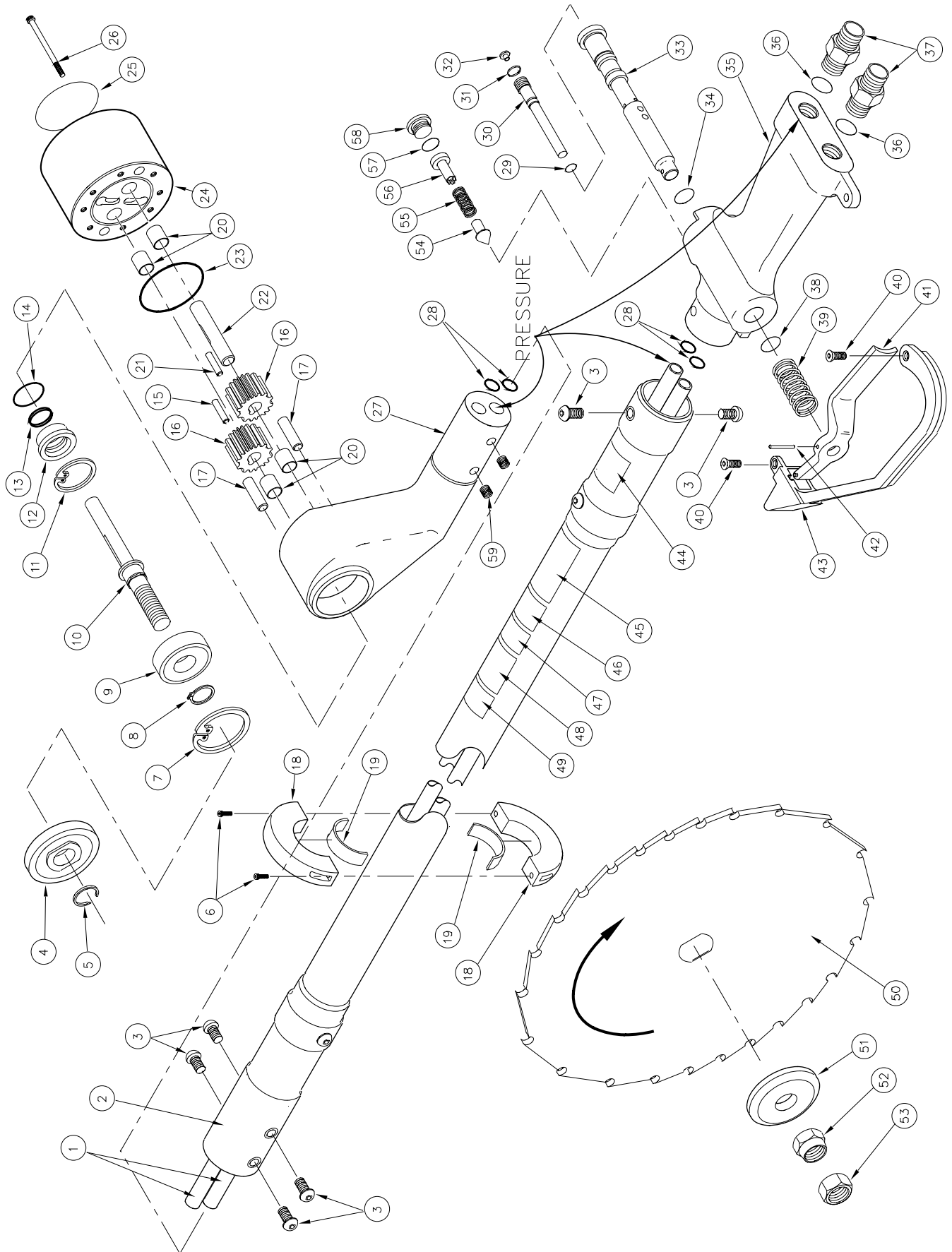

# CR27 PARTS LIST

ITEM	PART NO.	QTY	DESCRIPTION
1	00042	2	OIL TUBE ASSY
2	24829	1	OUTER TUBE ASSY
3	18089	6	CAPSCREW, BUTTONHEAD, 1/4-20 × 3/8
4	00227	1	FIXED COLLAR
5	00103	1	RETAINING RING
6	07407	2	CAPSCREW, HEX SOCKET HEAD, 10-32 × 3/4
7	00118	1	RETAINING RING
8	00008	1	RETAINING RING
9	00007	1	BALL BEARING
10	24842	1	MOTOR SHAFT
11	04856	1	RETAINING RING
12	19215	1	SEAL LINER
13	00173	1	QUAD RING
14	60804	1	O-RING
15	03227	1	NEEDLE ROLLER
16	04106	2	DRIVE GEAR
17	00289	2	DOWEL PIN
18	07305	2	HAND GUARD
19	11458	2	LINER
20	04041	4	DU BUSHING
21	04044	1	NEEDLE ROLLER
22	07612	1	IDLER SHAFT
23	00020	1	O-RING
24	07652	1	GEAR HOUSING ASSY (INCL ITEMS 17, 20 & 24)
25	24827	1	NAME TAG
26	00753	8	CAPSCREW, HEX SOCKET HEAD, 10-24 × 1-1/4
27	31689	1	FRONT BEARING HOUSING
28	16668	4	O-RING, 7/16 × 9/16 × 1/16 -017
	31700	1	MOTOR ASSY (INCL ITEMS 7 THRU 17, & 20 THRU 28)
29	00026	1	O-RING, 3/16 × 5/16 × 1/16 -008
30	19875	1	SELECTOR SCREW
31	16070	1	RETAINING RING
32	22807	1	PLUG (FURNISHED IN 26414 LOCK-OUT KIT)
33	31633	1	VALVE SPOOL
	67128	1	VALVE SPOOL (MODEL CR27191P ONLY)
34	07626	1	O-RING, 1/2 × 5/8 × 1/16
35	31630	1	VALVE HANDLE
36	01605	2	O-RING (INCL W/ ITEM 37)
37	00936	2	ADAPTER

ITEM	PART NO.	QTY	DESCRIPTION
38	07627	1	O-RING, 5/8 × 3/4 × 1/16
39	65151	1	SPRING
40	22147	2	CAPSCREW, HEX SOC FLAT HD, 1/4-20 × 3/4
41	51183	1	TRIGGER
42	01534	1	ROLL PIN
43	51182	1	TRIGGER GUARD
44	12412	1	ELECTRICAL WARNING STICKER
45	27694	1	DANGER STICKER
46	03784	1	5-7 GPM STICKER
47	05153	1	STANLEY STICKER
48	15863	1	WARNING STICKER
49	N/A	1	DIELECTRIC TEST STICKER
50	34356	1	SAW BLADE
51	00125	1	MOVEABLE COLLAR
52	24853	1	COLLET NUT
53	24850	1	LOCKING NUT
54	31186	1	POPPET
55	34303	1	SPRING
56	34257	1	POPPET STOP
57	03364	1	O-RING
58	03709	1	PLUG
59	24837	4	HELICOIL
	03972	1	FEMALE COUPLER
	03973	1	MALE COUPLER
	03971	1	COUPLER SET
	29829	1	SEAL KIT



Stanley Hydraulic Tools  
3810 SE Naef Road  
Milwaukie, Oregon 97267-5698 USA  
(503) 659-5660 / Fax (503) 652-1780  
[www.stanleyhydraulic.com](http://www.stanleyhydraulic.com)

**IMPORTANT**

To fill out a Product Warranty Recording form, and for information on your warranty, visit [Stanleyhydraulic.com](http://Stanleyhydraulic.com) and select the Warranty tab.  
**(NOTE:** The warranty recording form must be submitted to validate the warranty).



## Free Manuals Download Website

<http://myh66.com>

<http://usermanuals.us>

<http://www.somanuals.com>

<http://www.4manuals.cc>

<http://www.manual-lib.com>

<http://www.404manual.com>

<http://www.luxmanual.com>

<http://aubethermostatmanual.com>

Golf course search by state

<http://golfingnear.com>

Email search by domain

<http://emailbydomain.com>

Auto manuals search

<http://auto.somanuals.com>

TV manuals search

<http://tv.somanuals.com>