

stanton

CM.205

DUAL TABLETOP CD PLAYER WITH MIXER

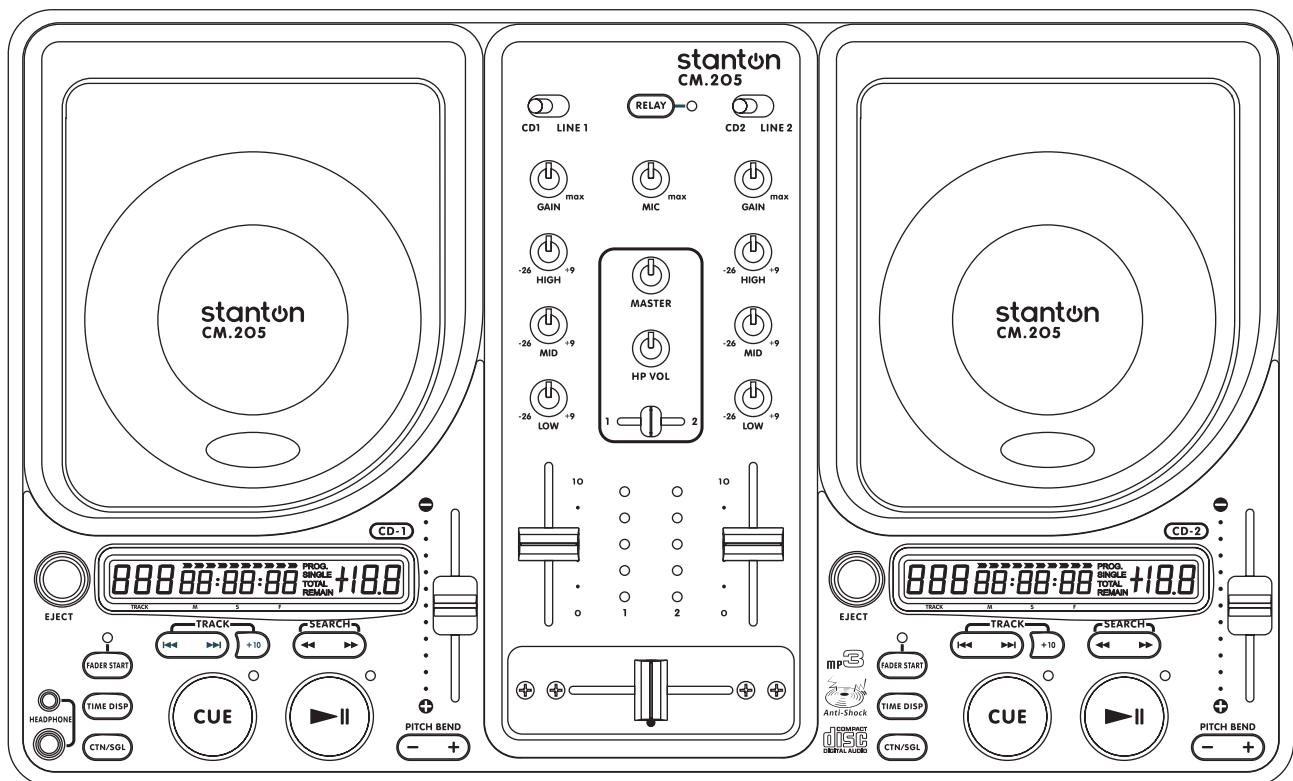

USER MANUAL

IMPORTANT SAFETY INSTRUCTIONS

1. Read Instructions – All the safety and operating instructions should be read before this product is operated.
2. Retain Instructions – The safety and operating instructions should be retained for future reference.
3. Heed Warnings – All warnings on the appliance and in the operating instructions should be adhered to.
4. Follow Instructions – All operating and use instructions should be followed.
5. Water and Moisture – The appliance should not be used near water - for example, near a bathtub, washbowl, kitchen sink, laundry tub, in a wet basement, or near a swimming pool, and the like.
6. Wall or Ceiling Mounting – The product should be mounted to a wall or ceiling only as recommended by the manufacturer.
7. Heat – Appliance should be situated away from heat sources such as radiators, heat registers, stoves, or other appliances (including amplifiers) that produce heat.
8. Power Sources – This product should be operated only from the type of power source indicated on the rating label. If you are not sure of the type of power supply to your home, consult your product dealer or local power company. For products intended to operate from battery power, or other sources, refer the operating instructions.
9. Grounding or Polarization – This product may be equipped with a polarized alternation-current line plug (a plug having one blade wider than the other). This plug will fit into the power outlet only one way. This is a safety feature. If you are unable to insert the plug fully into the outlet, try reversing the plug. If the plug should still fail to fit, contact your electrician to replace your obsolete outlet. Do not defeat the safety purpose of the polarized plug.
10. Power-Cord Protection –Power-supply cords should be routed so that they are not likely to be walked on or pinched by items placed upon or against them, paying particular attention to the cord in correspondence of plugs, convenience receptacles, and the point where they exit from the appliance.
11. Cleaning - The appliance should be cleaned only as recommended by the manufacturer. Clean by wiping with a cloth slightly damp with water. Avoid getting water inside the appliance.
12. For AC line powered units - Before returning repaired unit to user, use an ohmmeter to measure from both AC plug blades to all exposed metallic parts. The resistance should be more than 100,000 ohms
13. Non-use Periods –The power cord of the appliance should be unplugged from the outlet when left unused for a long period of time.
14. Object and Liquid Entry – Care should be taken so that objects do not fall and liquids are not spilled into the enclosure through openings
15. Damage Requiring Service – The appliance should be serviced by qualified service personnel when:
 - A. The power-supply cord or the plug has been damaged; or
 - B. Objects have fallen, or liquid has been spilled into the appliance; or
 - C. The appliance has been exposed to rain; or
 - D. The appliance does not appear to operate normally or exhibits a marked change in performance; or
 - E. The appliance has been dropped, or the enclosure is damaged.
16. Servicing –Do not attempt any service to the appliance beyond that described in the operating instructions. All other servicing should be referred to qualified service personnel.
17. Ventilation – Slots and openings in the cabinet are provided for ventilation and to ensure reliable operation of the product and to protect it from overheating, and these openings must not be blocked or covered. The openings should never be blocked by placing the product on a bed, sofa, rug, or other similar surface. This product should not be placed in a built-in installation such as a bookcase or rack unless proper ventilation is the manufacturer's instructions have been adhered to.
18. Attachments – do not use attachments not recommended by the product manufacturer as they may cause hazards.
19. Accessories – Do not place this product on an unstable cart, stand, tripod, bracket, or table. The product may fall, causing serious injury to a child or adult, and serious damage to the product. Use only with a cart, stand, tripod, bracket, or table recommended by the manufacturer, or sold with the product. Any mounting of the product should follow the manufacturer's instructions, and should use a mounting accessory recommended by the manufacturer.
20. Lightning – For added protection for this product during a lightning storm, or when it is left unattended and unused for long periods of time, unplug it from the wall outlet and disconnect the antenna or cable system. This will prevent damage to the product due to lightning and power-line surges.
21. Replacement Parts – When replacement parts are required, be sure the service technician has used replacement parts specified by the manufacturer or have the same characteristics as the original part. Unauthorized substitutions may result in fire, electric shock, or other hazards.
22. Safety Check – Upon completion of any service or repairs to this product, ask the service technician to perform safety checks to determine that the product is in proper operating condition.
23. This product is in compliance with EU WEEE regulations. Disposal of end of life product should not be treated as municipal waste. Please refer to your local regulations for instructions on proper disposal of this product.
24. Carts and Stands – The appliance should be used only with a cart or stand that is recommended by the manufacturer. An appliance and cart combination should be moved with care. Quick stops, excessive force, and uneven surfaces may cause the appliance and cart combination to overturn.
25. This device complies with Part 15 of the FCC Rules. Operation is subject to the following two conditions: (1) this device may not cause harmful interference, and (2) this device must accept any interference received, including interference that may cause undesired operation."



Stanton CM.205

FC Tested To Comply
With FCC Standards

FOR HOME OR OFFICE USE



CAUTION
RISK OF ELECTRIC SHOCK
DO NOT OPEN



CAUTION: To reduce the risk of electric shock, do not remove any cover. No user-serviceable parts inside. Refer servicing to qualified service personnel only.



The lightning flash with arrowhead symbol within the equilateral triangle is intended to alert the user to the presence of un-insulated "dangerous voltage" within the product's enclosure that may be of sufficient magnitude to constitute a risk of electric shock.



The exclamation point within the equilateral triangle is intended to alert the user to the presence of important operation and maintenance (servicing) instructions in the literature accompanying this appliance.

CAUTION: To prevent electric shock, do not use this polarized plug with an extension cord, receptacle or other outlet unless the blades can be fully inserted to prevent blade exposure.

INTRODUCTION

The CM.205 is the perfect CD mixer for the DJ looking for simplicity backed by professional quality. This versatile unit features dual top loading CD players and built-in line inputs for your iPod® and other portable media devices so you can easily access a variety of music sources! The CM.205 makes it easy to please the crowd in virtually any venue, from clubs, bars and restaurants to dance studios and mobile gigs.

FEATURES

CD Section:

MP3 playback
20-sec. anti-shock buffer per side prevents CD "skips"
Up to 8% pitch control with pitch bend
Fader start
Relay play

Mixer Section

2 line inputs to connect iPod®, other MP3 device or more CD players
Gain and 3 band EQ (+9/-26) per channel
User replaceable cross fader
1/4" mic input with volume control
Headphone output with cue pan

SETUP

Checking the Contents of Package

Check that the carton contains the following items:

- (1) CM.205 CD Mixer
- (2) Two (2) rack ears
- (3) Eight (8) screws
- (4) AC Power Cord
- (5) Owner's Manual (this book)
- (6) RCA to mini-jack cable for iPod®, computers or other MP3 players or CD players
- (7) Stanton product guide

***iPod® is a registered trademark for Apple Computer, Inc.

INSTALLING THE RACK EARS

• Installing the Rack Ears

:: STEP 1 ::

Place the unit upside down over a pad, pillow, or towel to avoid damaging the control surface.

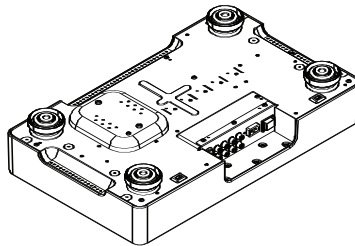

:: STEP 2 ::

Align the left rack ear with the screw holes as shown. Use 4 screws to lock the ear in place.

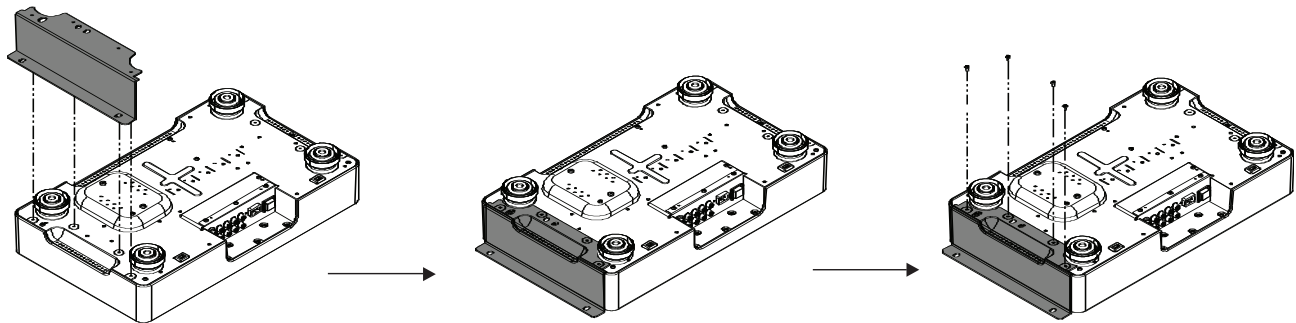

:: STEP 3 ::

Repeat step 2 with the right rack ear. You can now turn the unit over.

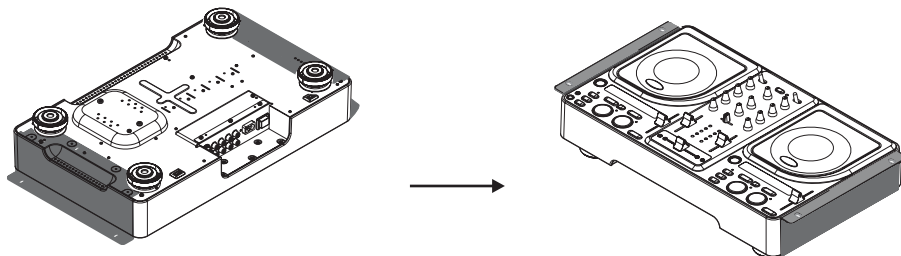

QUICK SETUP DIAGRAM

Study this setup diagram. Make sure all faders are at "zero" and all devices are off. First, connect all input sources and processors. Next, connect your microphone and monitor headphones. Finally, connect the stereo outputs to the power amplifier(s) and/or audio receivers. Additionally, you can connect the REC output to any recording device such as a CD or DVD recorder. Plug your mixer into AC power. Now you are ready to switch everything on. **IMPORTANT:** Always switch on your audio input sources such as turntables or CD players first, then your mixer, and finally any amplifiers. When turning off, always reverse this operation by turning off amplifiers, then your mixer, and then input devices.

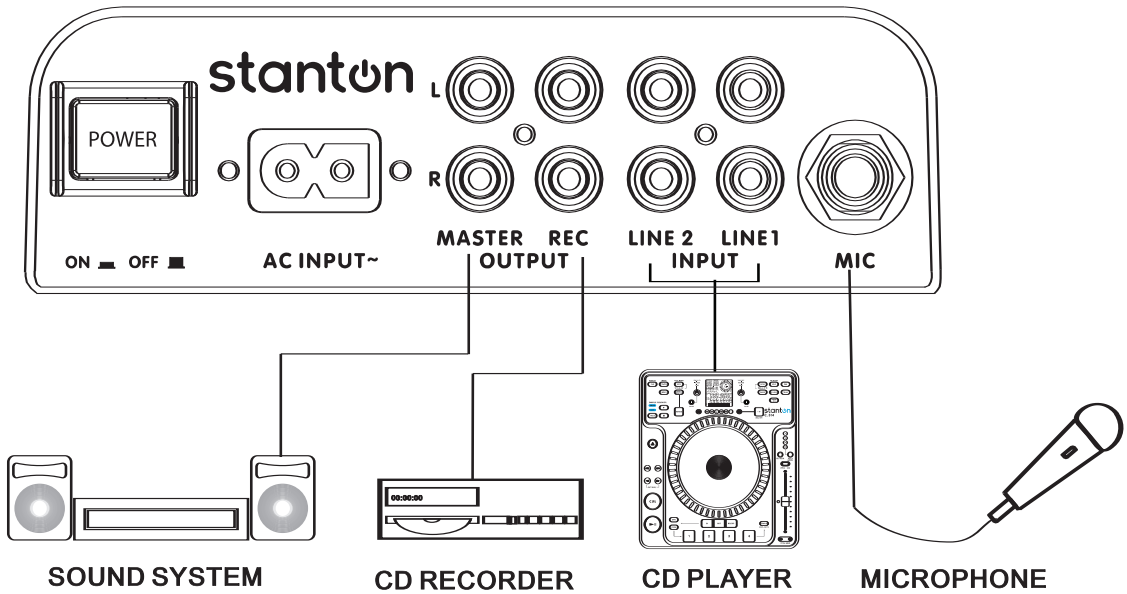

CD PLAYER FUNCTIONS

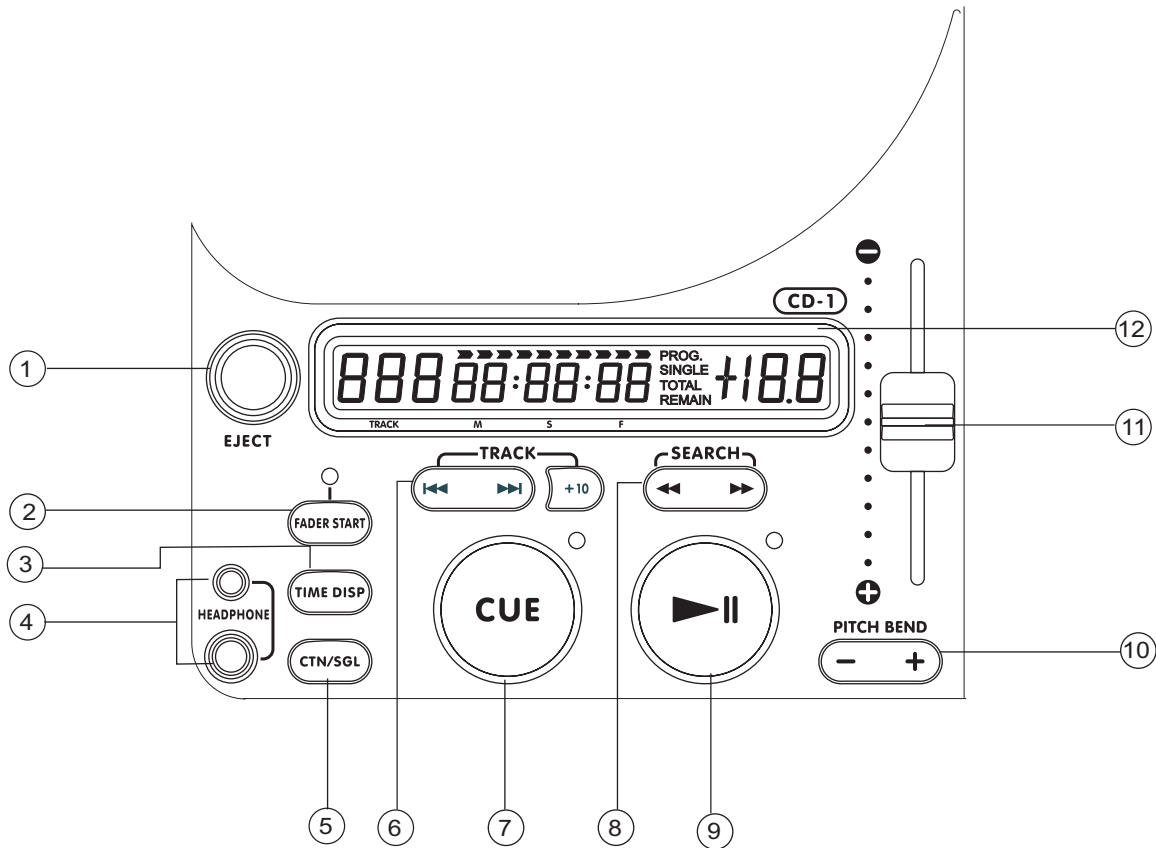

1. **EJECT** – Opens the CD door.
2. **FADER START** – You can use the crossfader to start and stop the CD decks. The fader start switch activates the fader start feature. When in the ON position, sliding the crossfader to either end will start the CD on that side and pause the CD on the other side and return to the cue point. Fader Start always starts from the cue point.
3. **TIME** – LCD display reads the time remaining or time elapsed, according to this button.
4. **HEADPHONE INPUT** – Insert either 1/8" or 1/4" plug for your headphones here.
5. **SGL/CTN** – Switches between Single or Continuous play mode.
6. **TRACK** – Used to select the track to be played. The +10 button skips 10 tracks at a time.
7. **CUE** – Used to recall and preview cue points. A new cue point is set every time playback is resumed.
8. **SEARCH** – Scans forward or back through the current track. This unit features four scan speeds. Keep the ◀◀ or ▶▶ button held for a few seconds to scan faster. Tap the button for frame search.
9. **PLAY/PAUSE** – Plays or pauses the CD. A new cue point is set every time playback is resumed.
10. **PITCH BEND** – Used to momentarily speed up or down the track. The maximum pitch range is up to +/- 8% from pitch setting.
11. **PITCH FADER** – Used to speed up or slow down current track. The maximum pitch range is up to +/- 8%.
12. **LCD DISPLAY** – Shows time (minutes, seconds, frame), and pitch information.

LCD DISPLAY FUNCTIONS

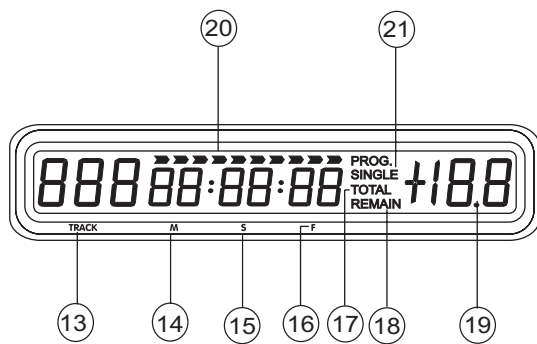

- 13. **TRACK** – Shows the current track that the unit is playing.
- 14. **MINUTES** – Shows the minutes elapsed or remaining depending on mode setting.
- 15. **SECONDS** – Shows the seconds elapsed or remaining depending on mode setting.

- 16. **FRAMES** – The CD Player breaks down a second into 75 frames for accurate cueing. This shows the frames elapsed or remaining depending on mode setting.
- 17. **TOTAL REMAIN** – Displays the total remaining time for the entire disc.
- 18. **REMAIN** – Displays the remaining time for the current track.
- 19. **PITCH** – Shows the percentage change in pitch.
- 20. **TIME BAR** – This bar gives a visual approximation of a track's or disc's remaining time. This bar will begin to flash when a CD or a track is ending.
- 21. **SINGLE** – Shows when the unit is set to play just one track at a time. When this is not lit, the CD will play continuously through all tracks. This function is controlled by the SING/CONT button.

MIXER FUNCTIONS

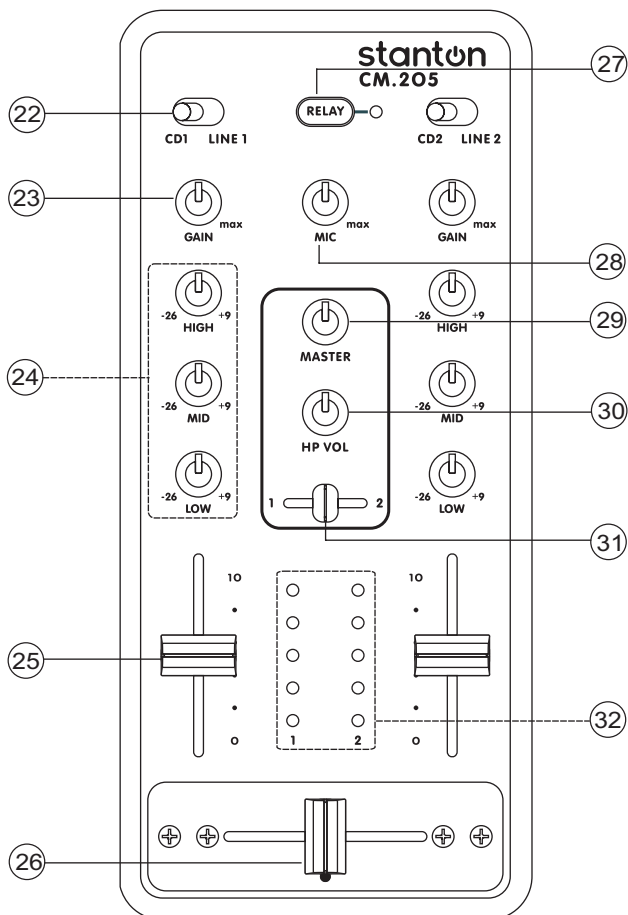

- 22. **INPUT TOGGLE SWITCH** – Switches the input source between the internal CD decks and the line inputs.
- 23. **CHANNEL GAIN** – Adjusts the pre-fader volume for cleaner sound.
- 24. **CHANNEL EQ** – Adjusts the high, mid and low frequency levels of each channel.
- 25. **INPUT FADER** – Controls individual source levels (channels) in the mix.
- 26. **REPLACEABLE CROSSFADER** – Achieves clean transitions between the two input channels. "Hard left" selects Channel 1. "Hard right" selects Channel 2. With the crossfader centered, both channels are live. Use the crossfader for fast and seamless fades from one channel to the other.
Note: The crossfader is user replaceable in case of failure. Simply unscrew the two large screws that hold it in place, lift it out and disconnect its cable. Re-attach the new crossfader and screw the mounting plate back onto the unit - you're back in business!
- 27. **RELAY** – Set both sides of the CD player to single mode on the control. When Disc 1 ends the CD player will automatically change to Disc 2 and when Disc 2 ends it will return to Disc 1.
- 28. **MIC INPUT GAIN** – Adjusts the microphone input level.
- 29. **MASTER LEVEL** – Controls the overall output level.
- 30. **HEADPHONE LEVEL** – Adjusts the cue volume.
- 31. **CHANNEL CUE SELECTOR** – Used to route channel audio to your headphones.
- 32. **LEVEL INDICATORS** – The dual LEDs indicators are used to indicate the pre-fader level of channels 1 and 2.

REAR PANEL FUNCTIONS

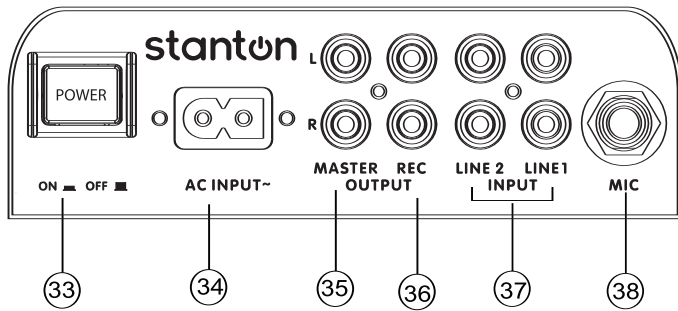

33. POWER SWITCH – Turns unit off and on. Note*** Remember to turn ALL volume levels down when turning on/off the unit.

34. AC INPUT – This is the connection for the supplied power cable.

35. MASTER OUTPUT – Unbalanced RCA connectors controlled by the Master level.

36. REC OUTPUT – Unbalanced RCA jacks used to send the output of the program to any connected recording device.

37. LINE INPUTS – Unbalanced RCA jacks for connecting stereo audio from line level sources such as CD players, DVD, MP3 players can be connected using the included RCA cable.

NOTE: Plug mono audio sources into both Left and Right inputs using a "Y" cable connector.

38. MIC INPUT – Insert your Microphone with 1/4 " plug here.

ADDITIONAL FUNCTIONALITY

UPDATING THE FIRMWARE

Firmware updates may, as necessary, become available from Stanton's website (www.stantondj.com) as downloadable ISO files, which are needed to create a bootable CD. We recommend using Magic ISO Maker (www.magiciso.com) PC software to burn the disc.

- Once you have burned a bootable disc from the ISO file, insert the CD into the CM.205 The display will read UPDATE, then SUCCESS.
- Repeat this process for both decks.
- Turn the unit off and back on to complete the update process

BURNING CD-R's CD-RW's

When burning CD-R's or CD-RW's for the CM.205, it is strongly recommended to set your burner at 8x write speed. You can change the write speed within your CD burning software. Check the following links for specific instructions:



- **Windows:** <http://support.microsoft.com/kb/309522/en-us>
- **Mac:** <http://docs.info.apple.com/article.html?artnum=303599>

SPECIFICATIONS

MIXER SECTION

FREQUENCY RESPONSE (Line to Master Output)	20 Hz to 20 kHz +/- 2 dB
THD+N (Line)	<0.01% at 1 kHz
S/N RATIO: REF TO MAX OUTPUT LEVEL (Dynamic Range)	>90 dB
Noise Floor (Line Input to Any Output) (Unbalanced Out)	< -85 dBV
CROSS TALK (Line to Line,Phono to Line,Line to Phono)	< -85 dB @ 1 kHz
CHANNEL FADER KILL	< -85 dB @ 1 kHz
CROSS FADER KILL	< -75 dB @ 1 kHz
Channel EQ	Hi +9 dB, -16dB @13HZ Mid +9 dB, -23dB @1HZ Low +9 dB, -23dB @70HZ

CD SECTION

FREQUENCY RESPONSE (CD to Master Output)	20 Hz to 20 kHz +/- 2.0 dB
THD+N WITH 20 KHZ LOW PASS FILTER	0.05% at 1 kHz
S/N RATIO:(ref Full-Scale)	>85 dB

MICROPHONE

FREQUENCY RESPONSE (Mic to Master Output)	20 Hz to 20 kHz +/- 2.0 dB
THD+N With 20 kHz Low Pass Filter	0.05% at 1 kHz
Mic EIN:	>110 dBV

INPUT/OUTPUT

LINE INPUTS	2 x Stereo RCA -14 dBV/nominal input level 18 k Ohm unbalanced
MIC INPUT	1x TRS -54 dBV/nominal input level 10k Ohm Balanced
MASTER OUTPUT	2x RCA unbalanced nominal load 10k Ohms
RECORD OUTPUT	2x RCA unbalanced -10dBV into 10k ohm load
HEADPHONE OUTPUT	1x 1/4" Phone Jack Max Load 33 Ohms 1x 1/8" Mini Phone Jack

GENERAL

SYSTEM	Compact Disc Digital Audio
DISC LOADING	Top Loading
DISPLAY	12 Digit LCD Display
PITCH CONTROL RANGE	Within +/- 8%
PITCH BEND	+/- 8%
PITCH ACCURACY	+/-0.15%

PHYSICAL SPECIFICATIONS

DIMENSIONS	440 (W) x 266(D) x110.5(H) mm
WEIGHT (UNIT)	4.4 Kgs.
OPERATING TEMPERATURE	0 °C to 40 °C
STORAGE TEMPERATURE	-20 °C to 50 °C
POWER SOURCE	US: 120V, 60Hz, AC 27W EU: 230V, 50Hz, AC 27W UK: 240V, 50Hz, AC 27W JPN:100V, 50/60Hz, AC 27W AUS:240V, 50Hz, AC 27W ARG:220V, 50Hz, AC 27W

REPLACEMENT PARTS

Contact your local reseller to order replacement parts.

WARRANTY & RETURN POLICY

Warranty

Through Stanton's authorized dealers around the World, Stanton, or one of Stanton's authorized distributors outside the U.S., will, without charge, repair or replace, at the sole discretion of the entity responsible for making the repair or providing the replacement, any Stanton merchandise proved defective in material or workmanship for a period of one (1) year following the date of original purchase. Exceptions to this warranty are as noted below:

The warranty for mechanical parts which are subject to wear and tear are limited to the earlier to occur of thirty (30) days following the date of original purchase or the following number of cycles: Faders - 15,000; Rotary potentiometers - 10,000; and Switches - 10,000.

Stanton will warrant all replacement parts and repairs for ninety (90) days from the date of original shipment. Repairs made necessary by reason of misuse, alteration, normal wear, or accident are not covered under this warranty.

Returns

Authorized Stanton dealers are only authorized to sell and distribute merchandise within a specific country. All goods requiring warranty repair or replacement must be returned (freight prepaid if not hand-delivered) to the authorized Stanton dealer from whom the merchandise was purchased and in the same country where the merchandise was purchased. For purposes of purchases made via the Internet, the merchandise must be returned to the authorized Stanton dealer in the country where the authorized Stanton dealer which sold the merchandise to purchaser is located and not the authorized Stanton dealer in the country where the purchaser is located or the country in which the merchandise was received. Any returns to a non-authorized dealer or to an authorized Stanton dealer not in the same country as the merchandise was intended to be sold or as set forth above will void this warranty.

To initiate a warranty repair, you must contact the authorized Stanton dealer from whom you purchased the merchandise, and follow such authorized Stanton dealer's return policy.

Stanton assumes no risk and shall be subject to no liability for damages or loss resulting from the specific use or application made of the merchandise. Stanton's liability for any claim, whether based on breach of contract, negligence, infringement of any rights of any party, or product liability, and relating to the merchandise shall not exceed the price received by Stanton from your purchase of such merchandise. In no event will Stanton be liable for any special, incidental or consequential damages (including loss of use, loss of profit and claims of third parties) however caused, whether by the negligence of Stanton or otherwise. To the extent permitted by law and except as otherwise provided above, Stanton disclaims any express or implied warranties of merchantability or fitness for a particular purpose.

The above warranty provides you with specific legal rights. You may also have additional rights, which are subject to variation from state to state and country to country.

If there is a dispute regarding the warranty of merchandise that does not fall under the warranty conditions stated above, please include a written explanation with the merchandise when returned pursuant to the terms and conditions set forth herein.

Please register your product online at www.stantondj.com or mail your completed warranty card to:

Stanton Magnetics, Inc, 3000 SW 42 St. Hollywood, Florida 33312.

Free Manuals Download Website

<http://myh66.com>

<http://usermanuals.us>

<http://www.somanuals.com>

<http://www.4manuals.cc>

<http://www.manual-lib.com>

<http://www.404manual.com>

<http://www.luxmanual.com>

<http://aubethermostatmanual.com>

Golf course search by state

<http://golfingnear.com>

Email search by domain

<http://emailbydomain.com>

Auto manuals search

<http://auto.somanuals.com>

TV manuals search

<http://tv.somanuals.com>