

stanton

S-650 MKII

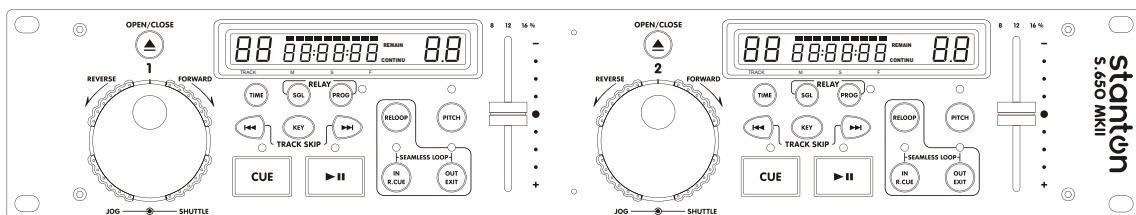
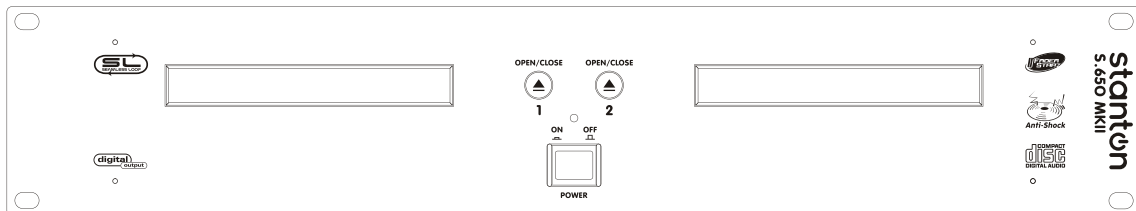

PROFESSIONAL DUAL CD PLAYER

IMPORTANT TO SAFETY

WARNING:

TO PREVENT FIRE OR SHOCK HAZARD, DO NOT EXPOSE THIS APPLIANCE TO RAIN OR MOISTURE.

CAUTION:

1. Handle the power supply cord carefully
Do not damage or deform the power supply cord. If it is damaged or deformed, it may cause electric shock or malfunction when used. When removing from wall outlet, be sure to remove by holding the plug attachment and not by pulling the cord.
2. In order to prevent electric shock, do not open the top cover. If a problem occurs, contact your dealer.
3. Do not place metal objects or spill liquid inside the CD player. Electric shock or malfunction may result.

Please, record and retain the Model name and serial number of your set shown on the rating label.

Model No. _____ Serial No. _____

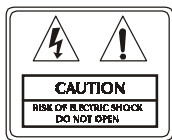

CAUTION: TO REDUCE THE RISK OF ELECTRIC SHOCK, DO NOT REMOVE THE COVER (OR BACK). THERE ARE NO SERVICEABLE PARTS INSIDE. REFER SERVICING TO QUALIFIED SERVICE PERSONNEL.



The lightning flash with arrowhead symbol, within an equilateral triangle, is intended to alert the user to the presence of uninsulated "dangerous voltage" within the product's enclosure that may be of sufficient magnitude to constitute a risk of electric shock to persons.



The exclamation point within an equilateral triangle is intended to alert the user to the presence of important operating and maintenance (servicing) instructions in the literature accompanying the appliance.

FOR U.S.A. & CANADA MODEL ONLY

CAUTION

TO PREVENT ELECTRIC SHOCK DO NOT USE THIS (POLARIZED) PLUG WITH AN EXTENSION CORD, RECEPTACLE OR OTHER OUTLET UNLESS THE BLADES CAN BE FULLY INSERTED TO PREVENT BLADE EXPOSURE.

NOTE:

This CD player uses the semiconductor laser. To allow you to enjoy music at a stable operation, it is recommended to use this in a room of 5°C 41°F - 35°C 95°F.

DATE LABEL

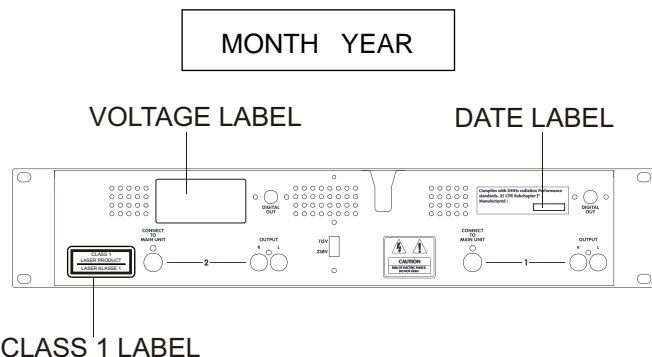

CAUTION:

USE OF CONTROLS OR ADJUSTMENTS OR PERFORMANCE OF PROCEDURES OTHER THAN THOSE SPECIFIED HEREIN MAY RESULT IN HAZARDOUS RADIATION EXPOSURE.

THE COMPACT DISC PLAYER SHOULD NOT BE ADJUSTED OR REPAIRED BY ANYONE EXCEPT PROPERLY QUALIFIED SERVICE PERSONNEL.

DOUBLE INSULATED - WHEN SERVICING, USE ONLY IDENTICAL REPLACEMENT PARTS.

NOTE:

This unit may cause interference to radio and television reception.

Line Voltage Selection (for multiple voltage model only)

★ The desired voltage may be set with the VOLTAGE SELECTOR switch on the rear panel, using a screwdriver.

★ Do not twist the VOLTAGE SELECTOR switch with excessive force as this may cause damage.

★ If the VOLTAGE SELECTOR switch does not move smoothly, please contact a qualified serviceman.

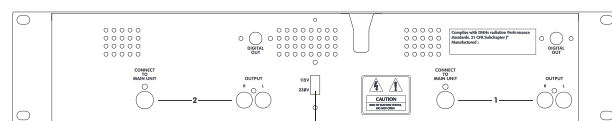

VOLTAGE SELECTOR SWITCH

IMPORTANT SAFETY INSTRUCTIONS

1. Read Instructions – All the safety and operating instructions should be read before this product is operated.
2. Retain Instructions - The safety and operating instructions should be retained for future reference.
3. Heed Warnings - All warnings on the appliance and in the operating instructions should be adhered to.
4. Follow Instructions - All operating and use instructions should be followed.
5. Water and Moisture - The appliance should not be used near water - for example, near a bathtub, washbowl, kitchen sink, laundry tub, in a wet basement, or near a swimming pool, and the like.
6. Carts and Stands - The appliance should be used only with a cart or stand that is recommended by the manufacturer.

An appliance and cart combination should be moved with care. Quick stops, excessive force, and uneven surfaces may cause the appliance and cart combination to overturn.



7. Wall or Ceiling Mounting - The product should be mounted to a wall or ceiling only as recommended by the manufacturer.
8. Heat - The appliance should be situated away from heat sources such as radiators, heat registers, stoves, or other appliances (including amplifiers) that produce heat.
9. Power Sources – This product should be operated only from the type of power source indicated on the rating label. If you are not sure of the type of power supply to your home, consult your product dealer or local power company. For products intended to operate from battery power, or other sources, refer the operating instructions.
10. Grounding or Polarization – This product may be equipped with a polarized alternation-current line plug (a plug having one blade wider than the other). This plug will fit into the power outlet only one way. This is a safety feature. If you are unable to insert the plug fully into the outlet, try reversing the plug. If the plug should still fail to fit, contact your electrician to replace your obsolete outlet. Do not defeat the safety purpose of the polarized plug.
11. Power-Cord Protection - Power-supply cords should be routed so that they are not likely to be walked on or pinched by items placed upon or against them, paying particular attention to the cord in correspondence of plugs, convenience receptacles, and the point where they exit from the appliance.
12. Cleaning - The appliance should be cleaned only as recommended by the manufacturer.
Clean by wiping with a cloth slightly damp with water. Avoid getting water inside the appliance.
13. For AC line powered units - Before returning repaired unit to user, use an ohm-meter to measure from both AC plug blades to all exposed metallic parts. The resistance should be more than 100,000 ohms.
14. Non-use Periods - The power cord of the appliance should be unplugged from the outlet when left unused for a long period of time.

15. Object and Liquid Entry - Care should be taken so that objects do not fall and liquids are not spilled into the enclosure through openings.
16. Damage Requiring Service - The appliance should be serviced by qualified service personnel when:
 - A. The power-supply cord or the plug has been damaged; or
 - B. Objects have fallen, or liquid has been spilled into the appliance; or
 - C. The appliance has been exposed to rain; or
 - D. The appliance does not appear to operate normally or exhibits a marked change in performance; or
 - E. The appliance has been dropped, or the enclosure damaged.
17. Servicing - The user should not attempt any service to the appliance beyond that described in the operating instructions. All other servicing should be referred to qualified service personnel.
18. Ventilation – Slots and openings in the cabinet are provided for ventilation and to ensure reliable operation of the product and to protect it from overheating, and these openings must not be blocked or covered. The openings should never be blocked by placing the product on a bed, sofa, rug, or other similar surface. This product should not be placed in a built-in installation such as a bookcase or rack unless proper ventilation is the manufacturer's instructions have been adhered to.
19. Attachments – do not use attachments not recommended by the product manufacturer as they may cause hazards.
20. Accessories – Do not place this product on an unstable cart, stand, tripod, bracket, or table. The product may fall, causing serious injury to a child or adult, and serious damage to the product. Use only with a cart, stand, tripod, bracket, or table recommended by the manufacturer, or sold with the product. Any mounting of the product should follow the manufacturer's instructions, and should use a mounting accessory recommended by the manufacturer.
21. Lightning – For added protection for this product during a lightning storm, or when it is left unattended and unused for long periods of time, unplug it from the wall outlet and disconnect the antenna or cable system. This will prevent damage to the product due to lightning and power-line surges.
22. Replacement Parts – When replacement parts are required, be sure the service technician has used replacement parts specified by the manufacturer or have the same characteristics as the original part. Unauthorized substitutions may result in fire, electric shock, or other hazards.
23. Safety Check – Upon completion of any service or repairs to this product, ask the service technician to perform safety checks to determine that the product is in proper operating condition.

NOTE ON USAGE

- Allow for sufficient heat dispersion when installed on a rack.
- Handle the power cord carefully.
- Hold the plug when unplugging the cord.
- Keep the appliance free from moisture, water, and dust.
- Unplug the power cord when not using the appliance for long periods of time.
- Do not obstruct the ventilation holes. (For units with ventilation holes)
- Do not drop foreign objects into the unit.
- Do not let insecticides, benzene, and thinner come in contact with the set.
- Never disassemble or modify the set in any way.

MAIN FEATURES

- 1) 20 seconds of anti-shock memory per deck
- 2) Instant start within 10 msec (sound is produced immediately when the PLAY button is pressed)
- 3) Seamless loop (uninterrupted loop playback)
- 4) Auto cue function (-48dB)
- 5) Real-time cue
- 6) Pitch range: +/-8%, +/-12%, +/-16%
- 7) Pitch display
- 8) Selectable elapsed, remain and total remain time display
- 9) Single / continuous play
- 10) Relay play allows consecutive playback during two decks
- 11) Frame search
- 12) 4 fast search mode
- 13) Transport protection
- 14) S/P DIF digital output
- 15) 20 programmable tracks
- 16) Fader start, Fader stop, (back cue), Relay playback.
- 17) Key correction

NAMES AND FUNCTIONS

Main Unit

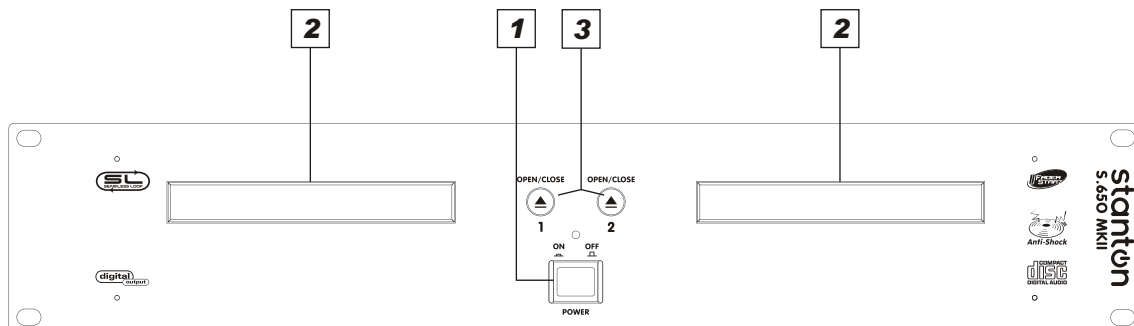

- (1) POWER (Power ON/OFF Switch)
When the POWER switch is pressed, the power turns on.
- (2) Disc Holder
Place the discs in the holder. Press the OPEN/CLOSE button to open and close the disc holder.
- (3) OPEN/CLOSE ▲ Button
Press it to open and close the disc holder. The control unit also includes OPEN/CLOSE button. The disc holder cannot be opened during playback, so stop playback before pressing the button.

NAMES AND FUNCTIONS

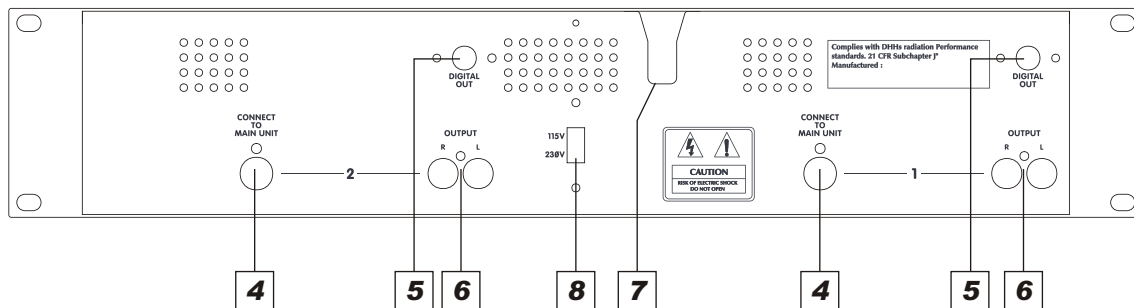

(4) REMOTE CONTROL CONNECTOR

Connect this connector to the control unit using the included control cord.

(5) DIGITAL OUT SOCKET

The music-signal of this socket is digital. Connect the output to the respective input of a digital amplifier for example.

(6) AUDIO OUT L and R

The audio signals from each player are output from these jacks.

(7) POWER CORD

(8) VOLTAGE SELECTOR (For Dual Voltage model only)

Set this switch to the voltage for your location.

Control Unit

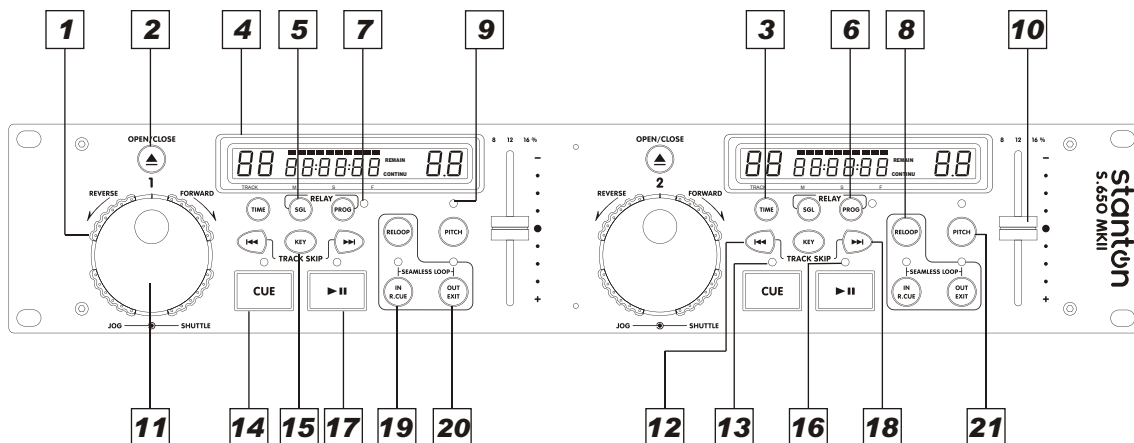

(1) SHUTTLE (Shuttle Dial)

Use the dial to select the scanning direction and speed. The disc is scanned in the forward direction when the shuttle dial is turned clockwise from the neutral position, in the reverse direction when the shuttle dial is turned counterclockwise. There are 4 scan speeds. The further the wheel is turned, the faster the scan speed.

(2) OPEN/CLOSE ▲ (Open/Close Button)

Press it to open and close the disc holder. The main unit also includes OPEN/CLOSE buttons. The disc holder cannot be opened during playback, so stop playback before pressing the button.

(3) TIME (Time Button)

Press this button to switch the time between the elapsed time and remaining time and total remaining time of the disc.

(4) LCD

(5) SGL (Single Button)

Press it to switch the single and continuous play modes. The SINGLE mode is indicated by the SINGLE indicator on the LCD and continuous mode is indicated by the CONTINUE indicator on the LCD.

(6) PROG (Program Button)

Press the PROGRAM button, the player will enter the program mode and stop the CD playback.

(7) PROGRAM Indicator

The PROGRAM LED lights when program mode is set.

(8) RELOOP

If a seamless loop has been made, but the CD Player is not actively in Seamless Loop mode, press the RELOOP button to reactivate the Seamless loop mode. RELOOP will appear in the LCD Display. To exit loop, press the OUT/EXIT button.

When the LOOP start point is set, the LED flashes.

When in LOOP mode, both LEDs will light up.

(9) PITCH Indicator

When the indicator lights, the pitch adjustment is enabled.

NAMES AND FUNCTIONS

(10) Pitch Slider

Use the slider to adjust the CD pitch. Slide up to decrease the pitch, down to increase the pitch.

(11) JOG (Jog Dial)

During PLAY, the jog dial is used temporarily bending the pitch (pitch bend). When CD is paused, the jog dial is used for frame search each segment of the dial represents a frame. Frame search is mostly used to set an accurate cue point.

(12) B. SKIP ◀◀

Use these buttons to go back to the beginning of the current track or select a previous track for playing.

(13) CUE Indicator

When in CUE mode, the CUE indicator lights.

(14) CUE (Cue Button)

Pressing the CUE button during play provides a return to the position at which play was started. If PAUSE is used before CUE or a CUE POINT was set, that will become the cue point. Alternately pressing the Play button and the CUE button allows the CD to be played from the same position any number of times. The CUE LED will light up from the time the CUE button is pressed until the CD has reset to the position at which play was started. Steady lighting of this LED indicates the ready condition. The CUE button can be held down to play a CD. When you release the CUE button it instantly returns to the CUE POINT.

(15) KEY

This button activates the KEY Correction function. This function will allow you to make adjustment to a track speed using the pitch control without altering a track perceived tonal pitch. When KEY is on, Pitch LED is flashing; and LED is off when KEY is off.

(16) PLAY Indicator

The PLAY indicator lights during play mode.

(17) PLAY/PAUSE Button

Use the button to start playback. Press once to start playback, once again to set the pause mode, and once more to resume playback.

(18) F. SKIP ▶▶

Use these buttons to skip to the next CD track.

(19) IN R.CUE

This allows you to set the cue point without stopping the play back. This button also sets the beginning of a seamless loop.

(20) OUT EXIT

This button is used to set the end point of a loop. Once the end point is set, the player automatically start looping. Press this button again to exit the loop.

(21) PITCH (Pitch Button)

Press PITCH button to switch on/off pitch.; hold the PITCH button down for more than 0.6 sec to switch pitch in +/-8% / +/-12% / +/-16%.

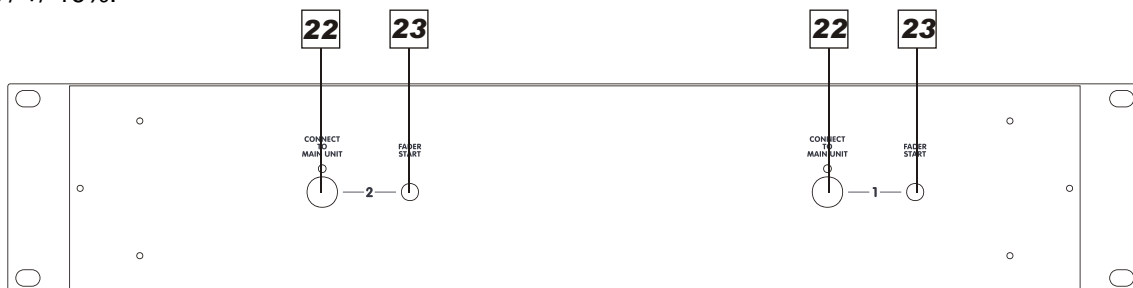

(22) CONTROL CONNECTOR

Connect this connector to the REMOTE connector on the main unit using the included control cord

(23) FADER START CONNECTOR

Via the Control socket, the respective CD-player can be remotely controlled. If you are using a mixer with fader start-function connect the player with the Control Out-socket. Please note that these sockets must never be connected with any voltage.

NAMES AND FUNCTIONS

LCD

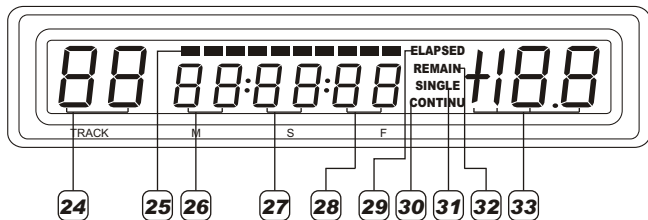

(24)~(27) TRACK, MINUTE, SECOND and FRAME Display

These displays indicate information for the CD's current position and time.

(28) BAR Indicator

These ten indicators provide a visual display of the approximate position of the pickup within the current track.

(29) ELAPSED Indicator

It indicates that the time shown for the display is the elapsed time.

(30) CONTINU Indicator

When the indicator lights, the function will cause the unit to play continuously.

(31) SINGLE Indicator

When the indicator lights, playback will stop at the beginning of the next track.

(32) REMAIN Indicator

It indicates that the time shown on the display is the remaining time of playing track.

(33) PITCH DISPLAY

Shows the current percentage of pitch change, pitch range is selectable from +/-8%, 12%, or 16%.

PREPARATIONS

1. Checking the Contents

Check that the carton contains the following items:

- 1) Main unit
- 2) Control unit
- 3) Operating instruction
- 4) Pair of RCA pin cord.
- 5) Control cords

2. Installing the Unit

Mount the unit into your console or rack with 19" EIA rack rails.

CAUTION:

The player will work normally when the main unit is mounted with the front panel at within 15 degrees of the vertical plane. If the unit is tilted excessively, discs may not be loaded or unloaded properly.

The control panel's LCD's are designed to be clearly visible within the angles shown in Figure 2. Mount the control unit so that the visual angle is within this range.

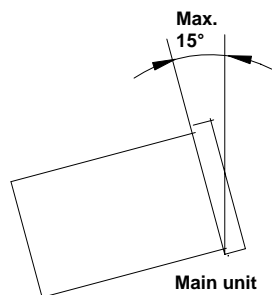

Figure 1

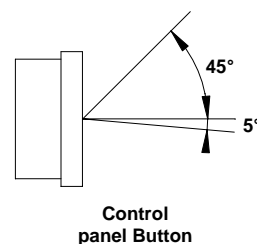

Figure 2

Connections

- 1) Turn off the POWER switch.
- 2) Connect the RCA pin cord to the input on your mixer.
- 3) Connect the control cords to the REMOTE connector on the main unit.

CAUTION:

- Be sure to use the supplied control cords. Using another type of cable may result in damage.
- Be sure the power is off when connecting the control cords. Otherwise the units may not work properly.

OPERATIONS

1. Opening and Closing the Disc Holder

- Turn the unit power on. Press the OPEN/CLOSE button to open the disc holder. OPEN/CLOSE buttons are provided on both the main unit and control unit.
- The disc holder cannot be opened during playback to prevent playback from being interrupted if the OPEN/CLOSE button is pressed accidentally. Stop the playback first, then press the OPEN/CLOSE button.

2. Loading discs

- Hold the disc by the edges and place it in the disc holder, then press the OPEN/CLOSE button again to close the disc holder. The unit will show the total track number and the total playing time for about 2 seconds then enter the cue condition, the cue point will be set to the music starting point of the first track automatically.

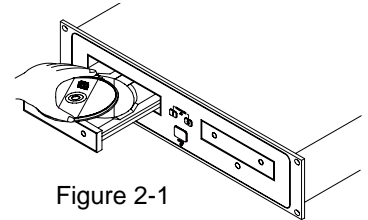

Figure 2-1

CAUTION:

- Do not place any foreign objects in the disc holder, and do not place more than one disc in the disc holder at a time.
- Do not push the disc holder in manually when the power is off, as this may result in malfunction and damages the player.

3. Selecting Tracks

- Press the SKIP button once to move to next higher or lower track.
- Hold the SKIP button to change tracks continuously at a higher speed.
- When a new track is selected during playback, playback begins as soon as the skip search operation is completed.
- If the skip ►► button is pressed while at the last track, the first track is selected. In the same way, if the skip ◀◀ button is pressed while at the first track, the last track is selected.

4. Starting Playback

- Press the PLAY/PAUSE button during the pause or cue to start playback, the PLAY indicator lights when playback starts.



Figure 4-1

5. Stopping Playback

There are two ways to stop playback.

1. Press the PLAY/PAUSE button during playback to pause at that point.
2. Press the CUE button during playback to return to the cue point and pause.

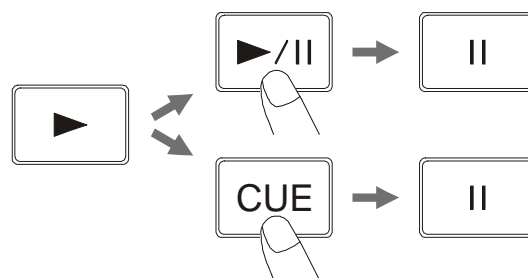

Figure 5

OPERATIONS

6. Pausing

- Press the PLAY/PAUSE button to switch between play and pause.
- The play indicator flashes when the pause mode is set.
- Figure 6 show the relationship between the play and pause.

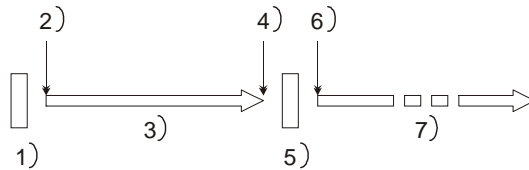

Figure 6

- 1) The player has completed the cue or pause operation and is waiting for the play start command.
- 2) When the PLAY/PAUSE button is pressed and enter play mode.
- 3) Playing.
- 4) The pause mode is set when the PLAY/PAUSE button is pressed again
- 5) Pausing.
- 6) Playback resumes when the PLAY/PAUSE button is pressed again.
- 7) Playing.

7. Cueing

"Cueing" is the action of preparing for playback; when the Cue button is pressed, playback return to the cue point and enters pause mode. When the PLAY/PAUSE button is pressed during the cue mode, playback starts.

Cue point setting:

A. Playback starts from pause (using the jog wheel to set the start point) or skip to a new track during play or pause. The beginning play point will be set to the cue point.

Or

B. Press the IN/R.CUE button during playback to set the new cue point ("CUE on the fly").

To return to Cue point press Cue Button. This will return to point A or B above.

The player has completed the cue or pause operation and is waiting for the play start command.

When the PLAY/PAUSE button is pressed, playback starts.

NOTE: During cue mode, if the CUE button is pressed and hold, playback will start from the cue point, when the button is released, the player will return to the cue mode automatically, it allows you to check the cue point.

8. Frame search

- Frame search is a function for monitoring the sound at a certain section of the disc and manually changing the position. Searching is used to set play start points with precision.
- Turn the JOG dial while in pause or cue mode to begin searching. The sound for one revolution of the disc is output repeatedly. The point at which the sound starts is indicated on the LCD.
- When the JOG dial is turned, the point from which the sound is output moves a number of frames corresponding to the number of the clicks, and the time display on the LCD also changes.
- The search point moves in the forward direction when the JOG dial is turned clockwise, in the reverse direction when the JOG dial is turned counterclockwise.

9. Scanning (Fast forward/Fast backward)

- Scanning is a function for moving quickly forward or backward when the SHUTTLE is rotated.
- This unit supports 4 different speeds according to the rotating angle of the SHUTTLE.
- Turn the shuttle dial to begin scanning. The disc moves rapidly forward or backward and the sound is output. The current scan point is indicated on the LCD.
- Turn the shuttle dial clockwise to scan in the forward direction, counterclockwise to scan in the reverse direction.

10. Time display

Press TIME button to select time display mode:

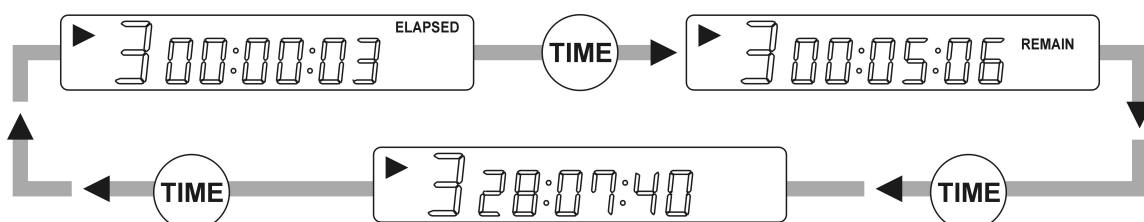

OPERATIONS

11. Matching the Beats Per Minute (BPM)

There are two tools available for matching the BPM of the two CDs:

- ① Use the pitch slider to adjust the BPM.
- ② Turn the JOG dial to change the BPM temporarily.

1) Pitch Slider

- ① To adjust the BPM by sliding the pitch slider up or down, press the PITCH button to turn on the PITCH adjustment function before using.
- ② Slide the pitch slider up to decrease BPM, or down to increase BPM.

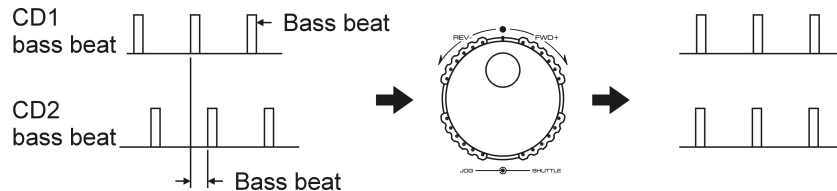

2) Turn the JOG dial

Turn the jog dial clockwise during play to increase the BMP in the forward direction, counterclockwise to decrease the BMP in the reverse direction. The faster you turn the wheel, the more the BMP changes. The BMP changes with a range of +/-16%.

When you release jog wheel, the CD will return to the tempo indicated by the pitch slider.

12. Program play

- ① Press the PROGRAM button, the player will enter the program mode and the CD will stop rotating.
- ② Select the desired track by pressing the SKIP button, then press the PROGRAM button again. The selected track will be added to the program sequence.
- ③ Repeat step 2 operation. A maximum of 20 tracks can be programmed at one time.
- ④ Press the PLAY/PAUSE button to start the program play from the first selection.
- ⑤ Press the program button again during program play to stop play.
- ⑥ Press and hold the program button more than 2 seconds to cancel the program mode and erase all the current program contents.

13. Loop Play

You can create a seamless loop between two points continuously.

- a- Press PLAY/PAUSE BUTTON so a CD is playing.
The PLAY/PAUSE BUTTON'S LED lights.



- b- Press IN/R.CUE BUTTON . This sets the starting point of the SEAMLESS LOOP. The IN/R.CUE BUTTON LED will light.

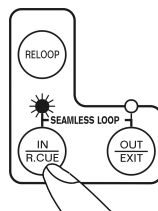

- c- Press OUT/EXIT BUTTON to set desired ending point of the SEAMLESS LOOP. You will know you are in SEAMLESS LOOP mode because IN/R.CUE and OUT/EXIT LED will light and flash. Sound will continue with no interruption (SEAMLESS LOOP).

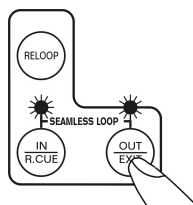

OPERATIONS

d- To exit SEAMLESS LOOP, press OUT/EXIT BUTTON . LED will stay on but not flash. Music will resume normal play.

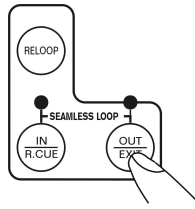

e- To replay loop, press the RELOOP BUTTON. IN/R.CUE and OUT/EXIT LED will all begin flashing again.

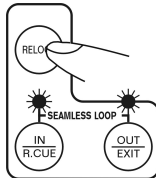

14. Relay Play

The relay play is explained as below.

- ♦ Set both players to single play mode (the SINGLE indicators will lit in the displays).
- ♦ Begin playback on the first player.
- ♦ When the currently playing track ends, playback will begin automatically on the standby player.
- ♦ The first player will enter standby mode at the beginning of the next track on its disc.
- ♦ By repeating this operation, the two players can be used to perform continuous relay play.
- ♦ By loading new discs on the standby player, you can construct a continuous program of whatever tracks you wish.
- ♦ By setting a cue point on the standby player, you can perform relay to any desired cue point on the selected track.

NOTE:

Relay play may not work properly if the audio out jacks on the two players are not connected to the same audio amplifier.

Press PROG and SGL button to switch relay function; the indicator on the LCD track display when flash when relay is on.

15. Key

This button activates the KEY Correction function. This function will allow you to make adjustment to a track speed using the pitch control without altering a track perceived tonal pitch. When KEY is on, Pitch LED is flashing; and LED is off when KEY is off.

16. Fader Start Playback

When the player's CONTROL jack is connected to a mixer with fader start connection, raising the DJ Mixer's channel fader causes the player's standby mode to be released, starting playback instantly. The player's fader start operation can also be used to produce cross-fader effects. Restoring the fader position returns the player to its cue point (back cue) automatically.

The following operations are performed on the DJ Mixer.

- ♦ Set CROSS FADER switch to ON.
- ♦ Set FADER START switch to ON.
- ♦ When "A" is in standby mode at cue point, move the CROSS FADER slider from right to left to automatically start playback on "A".

When "B" is in standby mode at cue point, move the CROSS FADER slider from left to right to automatically start playback on "B". ("A" will simultaneously be back cued (returns to cue point)).

BEFORE SWITCHING OFF THE POWER

When you have finished using the CD player, before switching off the power, be sure that the disc holder had been closed with the OPEN/CLOSE button.

CAUTION:

Do not forcibly close the disc holder when the power is off.

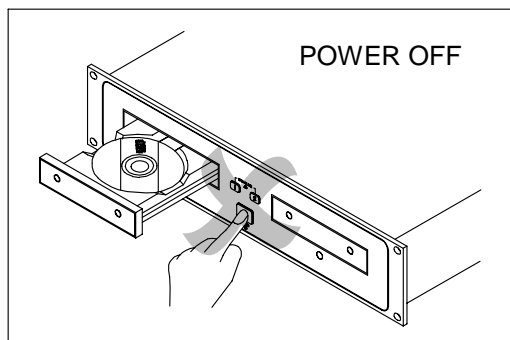

Do not switch off the power when the disc holder is open.

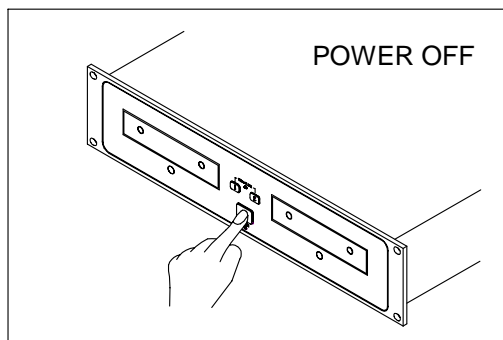

Switch off the power after the disc holder has been closed with the OPEN/CLOSE button.

COMPACT DISCS

1. Precautions on handling compact discs

- ◆ Do not allow fingerprints, oil or dust to get on the surface of the disc.
- ◆ If the disc is dirty, wipe it off with a soft dry cloth.
- ◆ Do not use benzene, thinner, water, record spray, electrostatic-proof chemicals, or silicone-treated cloths to clean discs.
- ◆ Always handle discs carefully to prevent damaging the surface; in particular when removing a disc from its case or returning it.
- ◆ Do not bend the disc.
- ◆ Do not apply heat.
- ◆ Do not enlarge the hole in the center of the disc.
- ◆ Do not write on the label (printed side) with a hard-tipped implement such as a pencil or ball point pen.
- ◆ Condensation will form if a disc is brought into a warm area from a colder one, such as outdoors in winter. Do not attempt to dry the disc with a hair dryer, etc..

2. Precaution on storage

- After playing a disc, always unload it from the player.
- Always store the disc in the jewel case to protect from dirt or damage.
- Do not place discs in the following areas:
 - ① Areas exposed to direct sunlight for a considerable time.
 - ② Areas subject to accumulation of dust or high humidity.
 - ③ Areas affected by heat from indoor heaters, etc..

SPECIFICATIONS

Dimensions:	Main unit:	482(W) x 88.8(H) x 251(D) mm
	Control unit:	482(W) x 88.8(H) x 60(D) mm
Weight:	Player unit:	5 kgs
	Control unit:	2 kgs
Power supply:	Dual Voltage:	AC 115/230V AC, 50/60Hz
	Single Voltage:	AC 100V, 50Hz (For Japan) / AC 110V, 60Hz (For Taiwan)
		AC 120V, 60Hz (For U.S.A., Canada) / AC 127V, 60Hz (For Mexico)
		AC 220V, 50Hz (For United Arab Emirates, Chile, Argentina)
		AC 220V, 60Hz (For Philippines)
		AC 230V, 50Hz (For Europe, U.K., New Zealand, South Africa, Singapore, Israel)
		AC 240V, 50Hz (For Australia)
Power consumption:		25W

Stanton Magnetics, Inc. – Warranty Provision – Returns for Repairs or Replacement

WARRANTY

Through Stanton's authorized dealers around the World, Stanton, or one of Stanton's authorized distributors outside the U.S., will, without charge, repair or replace, at the sole discretion of the entity responsible for making the repair or providing the replacement, any Stanton merchandise proved defective in material or workmanship for a period of one (1) year (three (3) years for C.D. players) following the date of original purchase. Exceptions to this warranty are as noted below:

The warranty for mechanical parts which are subject to wear and tear are limited to the earlier to occur of thirty (30) days following the date of original purchase or the following number of cycles: Faders - 15,000; Rotary potentiometers - 10,000; and Switches - 10,000.

Stanton will warrant all replacement parts and repairs for ninety (90) days from the date of original shipment. Repairs made necessary by reason of misuse, alteration, normal wear, or accident are not covered under this warranty.

RETURNS

Authorized Stanton dealers are only authorized to sell and distribute merchandise within a specific country. All goods requiring warranty repair or replacement must be returned (freight prepaid if not hand-delivered) to the authorized Stanton dealer from whom the merchandise was purchased and in the same country where the merchandise was purchased. For purposes of purchases made via the Internet, the merchandise must be returned to the authorized Stanton dealer in the country where the authorized Stanton dealer which sold the merchandise to purchaser is located and not the authorized Stanton dealer in the country where the purchaser is located or the country in which the merchandise was received. Any returns to a non-authorized dealer or to an authorized Stanton dealer not in the same country as the merchandise was intended to be sold or as set forth above will void this warranty.

To initiate a warranty repair, you must contact the authorized Stanton dealer from whom you purchased the merchandise, and follow such authorized Stanton dealer's return policy.

Stanton assumes no risk and shall be subject to no liability for damages or loss resulting from the specific use or application made of the merchandise. Stanton's liability for any claim, whether based on breach of contract, negligence, infringement of any rights of any party, or product liability, and relating to the merchandise shall not exceed the price received by Stanton from your purchase of such merchandise. In no event will Stanton be liable for any special, incidental or consequential damages (including loss of use, loss of profit and claims of third parties) however caused, whether by the negligence of Stanton or otherwise. To the extent permitted by law and except as otherwise provided above, Stanton disclaims any express or implied warranties of merchantability or fitness for a particular purpose.

The above warranty provides you with specific legal rights. You may also have additional rights, which are subject to variation from state to state and country to country.

If there is a dispute regarding the warranty of merchandise that does not fall under the warranty conditions stated above, please include a written explanation with the merchandise when returned pursuant to the terms and conditions set forth herein.

Please register your product online at www.stantondj.com or mail your completed warranty card to:

Stanton Magnetics, Inc, 3000 SW 42 St. Hollywood, Florida 33312.

STANTON WARRANTY REGISTRATION CARD

If you have internet access, please register your product at www.stantondj.com. Otherwise, return this card completely filled out in order to validate your warranty.

PERSONAL INFO

Name

Address

City **State** **Zip**

Country

Telephone

PRODUCT INFO

Model Number

Serial Number

Date of Purchase

Where did you buy this product?

cut along dotted line

**PLACE
STAMP
HERE**

**Stanton Magnetics, Inc.
3000 SW 42nd Street
Hollywood, FL 33312
U.S.A.**

Free Manuals Download Website

<http://myh66.com>

<http://usermanuals.us>

<http://www.somanuals.com>

<http://www.4manuals.cc>

<http://www.manual-lib.com>

<http://www.404manual.com>

<http://www.luxmanual.com>

<http://aubethermostatmanual.com>

Golf course search by state

<http://golfingnear.com>

Email search by domain

<http://emailbydomain.com>

Auto manuals search

<http://auto.somanuals.com>

TV manuals search

<http://tv.somanuals.com>