

STANTON

S-350

PROFESSIONAL CD PLAYER

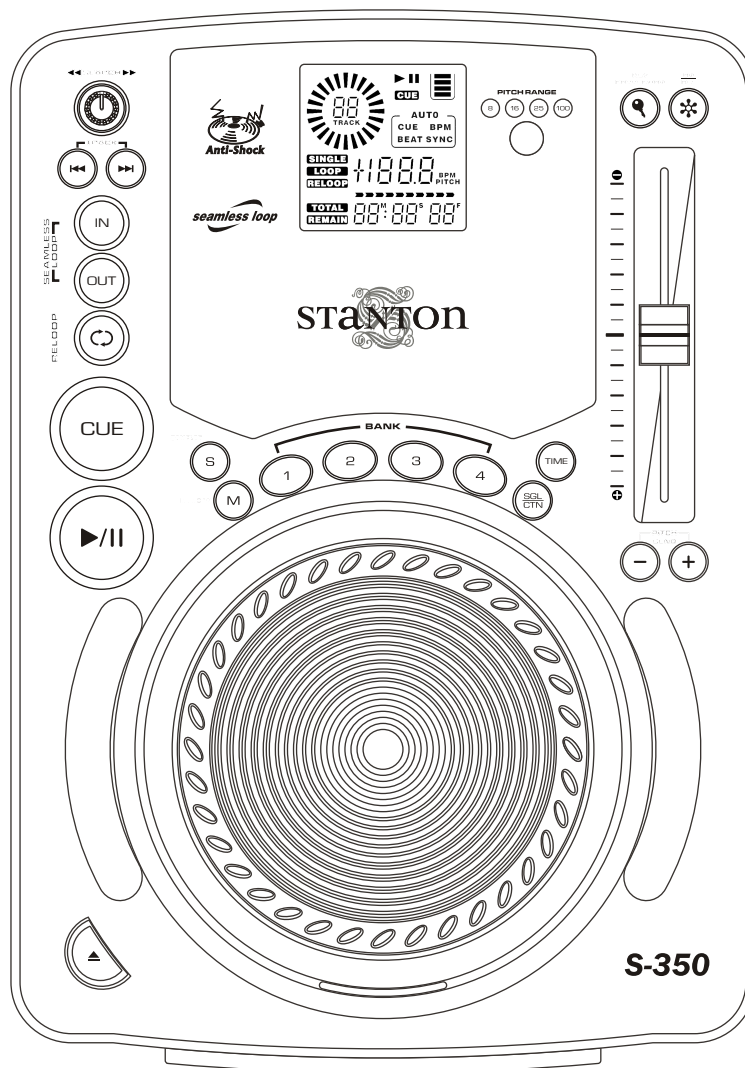

USERS MANUAL

Important To Safety

WARNING:

TO PREVENT FIRE OR SHOCK HAZARD, DO NOT EXPOSE THIS APPLIANCE TO RAIN OR MOISTURE.

CAUTION:

1. Handle the power supply cord carefully
Do not damage or deform the power supply cord. If it is damaged or deformed, it may cause electric shock or malfunction when used. When removing from wall outlet, be sure to remove by holding the plug attachment and not by pulling the cord.
2. In order to prevent electric shock, do not open the top cover. If a problem occurs, contact your dealer.
3. Do not place metal objects or spill liquid inside the CD player. Electric shock or malfunction may result.

Please, record and retain the Model name and serial number of your set shown on the rating label.

Model No. _____ Serial No. _____

NOTE:

This CD player uses the semiconductor laser. To allow you to enjoy music at a stable operation, it is recommended to use this in a room of 5 41 - 35 95 .

DATE LABEL

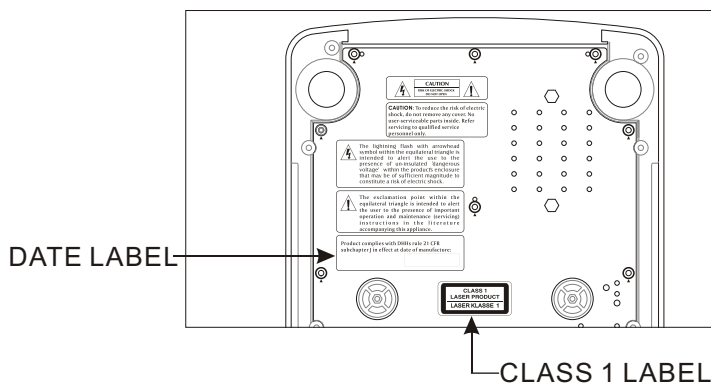



CAUTION
RISK OF ELECTRIC SHOCK
DO NOT OPEN

CAUTION: TO REDUCE THE RISK OF ELECTRIC SHOCK, DO NOT REMOVE THE COVER (OR BACK). THERE ARE NO SERVICEABLE PARTS INSIDE. REFER SERVICING TO QUALIFIED SERVICE PERSONNEL.

The lightning flash with arrowhead symbol, within an equilateral triangle, is intended to alert the user to the presence of an insulated "dangerous voltage" within the product's enclosure that may be of sufficient magnitude to constitute a risk of electric shock to persons.

The exclamation point within an equilateral triangle is intended to alert the user to the presence of important operating and maintenance (servicing) instructions in the literature accompanying the appliance.

CAUTION:

USE OF CONTROLS OR ADJUSTMENTS OR REFORMANCE OF PROCEDURES OTHER THAN THOSE SPECIFIED HEREIN MAY RESULT IN HAZARDOUS RADIATION EXPOSURE.

THE COMPACT DISC PLAYER SHOULD NOT BE ADJUSTED OR REPAIRED BY ANYONE EXCEPT PROPERLY QUALIFIED SERVICE PERSONNEL.

DOUBLE INSULATED - WHEN SERVICING, USE ONLY IDENTICAL REPLACEMENT PARTS.

NOTE:
This unit may cause interference to radio and television reception.

FOR U.S.A. & CANADA MODEL ONLY

CAUTION

TO PREVENT ELECTRIC SHOCK DO NOT USE THIS (POLARIZED) PLUG WITH AN EXTENSION CORD, RECEPTACLE OR OTHER OUTLET UNLESS THE BLADES CAN BE FULLY INSERTED TO PREVENT BLADE EXPOSURE.

Important Safety Instructions

1. Read Instructions – All the safety and operating instructions should be read before this product is operated.
2. Retain Instructions - The safety and operating instructions should be retained for future reference.
3. Heed Warnings - All warnings on the appliance and in the operating instructions should be adhered to.
4. Follow Instructions - All operating and use instructions should be followed.
5. Water and Moisture - The appliance should not be used near water - for example, near a bathtub, washbowl, kitchen sink, laundry tub, in a wet basement, or near a swimming pool, and the like.
6. Carts and Stands - The appliance should be used only with a cart or stand that is recommended by the manufacturer.
An appliance and cart combination should be moved with care. Quick stops, excessive force, and uneven surfaces may cause the appliance and cart combination to overturn.

7. Wall or Ceiling Mounting - The product should be mounted to a wall or ceiling only as recommended by the manufacturer.
8. Heat - The appliance should be situated away from heat sources such as radiators, heat registers, stoves, or other appliances (including amplifiers) that produce heat.
9. Power Sources – This product should be operated only from the type of power source indicated on the making label. If you are not sure of the type of power supply to your home, consult your product dealer or local power company. For products intended to operate from battery power, or other sources, refer the operating instructions.
10. Polarization – This product may be equipped with a polarized alternation-current line plug (a plug having one blade wider than the other). This plug will fit into the power outlet only one way. This is a safety feature. If you are unable to insert the plug fully into the outlet, try reversing the plug. If the plug should still fail to fit, contact your electrician to replace your obsolete outlet. Do not defeat the safety purpose of the polarized plug.
11. Power-Cord Protection - Power-supply cords should be routed so that they are not likely to be walked on or pinched by items placed upon or against them, paying particular attention to the cord in correspondence of plugs, convenience receptacles, and the point where they exit from the appliance.
12. Cleaning - The appliance should be cleaned only as recommended by the manufacturer.
Clean by wiping with a cloth slightly damp with water. Avoid getting water inside the appliance.
13. For AC line powered units - Before returning repaired unit to user, use an ohm-meter to measure from both AC plug blades to all exposed metallic parts. The resistance should be more than 100,000 ohms.
14. Non-use Periods - The power cord of the appliance should be unplugged from the outlet when left unused for a long period of time.
15. Object and Liquid Entry - Care should be taken so that objects do not fall and liquids are not spilled into the enclosure through openings.
16. Damage Requiring Service - The appliance should be serviced by qualified service personnel when:
 - A. The power-supply cord or the plug has been damaged; or
 - B. Objects have fallen, or liquid has been spilled into the appliance; or
 - C. The appliance has been exposed to rain; or
 - D. The appliance does not appear to operate normally or exhibits a marked change in performance; or
 - E. The appliance has been dropped, or the enclosure damaged.
17. Servicing - The user should not attempt any service to the appliance beyond that described in the operating instructions. All other servicing should be referred to qualified service personnel.
18. Ventilation – Slots and openings in the cabinet are provided for ventilation and to ensure reliable operation of the product and to protect it from overheating, and these openings must not be blocked or covered. The openings should never be blocked by placing the product on a bed, sofa, rug, or other similar surface. This product should not be placed in a built-in installation such as a bookcase or rack unless proper ventilation is the manufacturer's instructions have been adhered to.
19. Attachments – do not use attachments not recommended by the product manufacturer as they may cause hazards.
20. Accessories – Do not place this product on an unstable cart, stand, tripod, bracket, or table. The product may fall, causing serious injury to a child or adult, and serious damage to the product. Use only with a cart, stand, tripod, bracket, or table recommended by the manufacturer, or sold with the product. Any mounting of the product should follow the manufacturer's instructions, and should use a mounting accessory recommended by the manufacturer.
21. Lightning – For added protection for this product during a lightning storm, or when it is left unattended and unused for long periods of time, unplug it from the wall outlet and disconnect the antenna or cable system. This will prevent damage to the product due to lightning and power-line surges.
22. Replacement Parts – When replacement parts are required, be sure the service technician has used replacement parts specified by the manufacturer or have the same characteristics as the original part. Unauthorized substitutions may result in fire, electric shock, or other hazards.
23. Safety Check – Upon completion of any service or repairs to this product, ask the service technician to perform safety checks to determine that the product is in proper operating condition.

Features

- 10 seconds of anti-shock memory
- Instant start
- Seamless loop
- Pitch range : +/-100% +/-0.1%
- 4 banks for Sampler and Cue memory, <5 sec. Each bank
- Mixer between music and sampler
- Auto cue function (-48dB)
- 127 *4 sampler (cues) can be memoried and share both sides
- Selectable elapsed, remain and total remaining time display
- Single/continuous play
- Relay play allows consecutive playback between two players
- Digital Output (S/PDIF digital audio coaxial)
- LCD display
- Key Correction

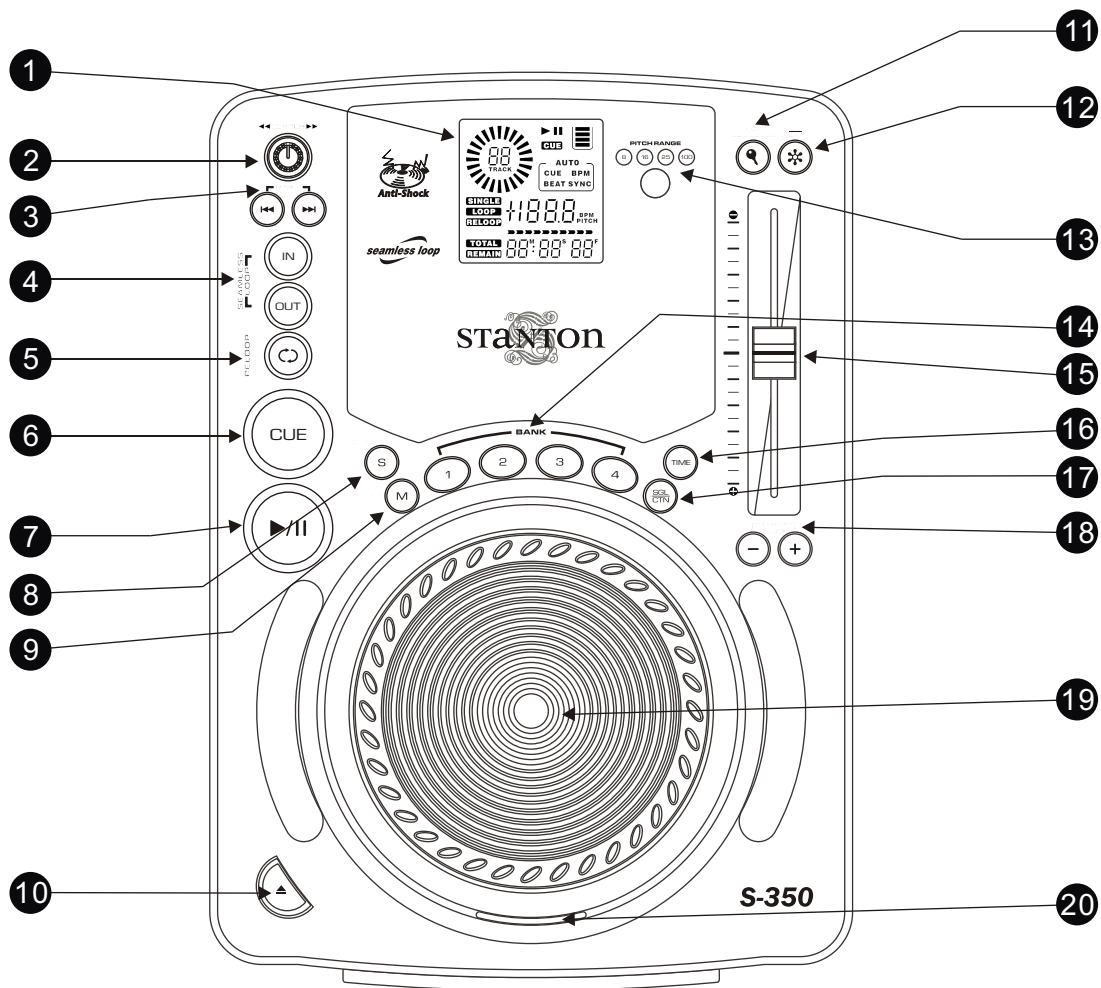
Controls and Functions



1. **DISPLAY PANEL** LCD-display for displaying the different modes and functions.
2. **SEARCH WHEEL** - This wheel has 4 forward and 4 reverse speed positions allowing you to quickly scan through tracks. The more you turn the wheel in either direction the faster you search.
3. **TRACK BUTTON** - These buttons are used to select a track. Tapping the button will forward/back skip to the next track, holding down the button will rapidly forward/back skip through the tracks.
4. **IN BUTTON** - This function allows you to set a cue point without music interrupt. This button also sets the starting point of a seamless loop.
OUT BUTTON - This button is used to set the ending point of a loop. A loop is started by pressing the IN button, pressing the OUT button set the loop ending point. The loop will continue to play until the OUT button is pressed once again.
5. **RELOOP BUTTON** - If a seamless loop has been made, but the CD player is not actively in seamless loop mode (a loop is not playing), pressing the RELOOP button will instantly reactivate the seamless loop mode. To exit loop, press the OUT button. LOOP and RELOOP will appear in the LCD display when the reloop function is available. During play mode, pressing the RELOOP button will instantly return play the last set point without interrupt of music.
6. **CUE BUTTON** - Pressing the CUE button during playback immediately pauses playback and returns the track to the last set cue point. In pause mode and the CD is at the cue point, press the CUE button to provide cue monitor. The red CUE LED will lit when the CD is at the cue point.
7. **PLAY/PAUSE BUTTON** - Each press of the button to change from play to pause or from pause to play. In skid mode, press this button to break or slow start.
8. **SAMPLER BUTTON** - Press this button, then press the desired BANK button to set the sampler mode. When sampler mode is set, the audio sample will play over (mixed with) the CD (if still playing). The audio sample can even play when there is no disc inside. The sampler will play once or continuous depending on mode. Press sampler button once for continuous play and LED is lit (static); Press button again for single play and LED flashes. Press again to cancel the sampler function and the LED is off.
9. **MEMORY BUTTON** - Press this button to set the memory mode, then press the desired BANK button to memorize the music from the last cue point. The music length to be memorized is determined by the length of BANK. When the memory mode is set, the MEMORY LED is lit. You can also memorize the BANKs, FX' parameter, and the last play mode (i.e. time, single/continuous, pitch select, activated FX) by pressing the memory for 1 sec. To recall the BANKs, just activate the memory mode before you load a new disc.
10. **EJECT BUTTON** - Press this button to eject disc. The disc will not eject unless the player is in Cue or Pause, this is to prevent accidentally ejecting the disc while in play mode.
11. **KEY CORRECTION BUTTON** - This button is used to activate Key Correction via the pitch controls. Key Correction mode allows tempo change while maintaining the original key. When the Key Correction is selected, the LED above the KEY CORRECTION button glows red.
12. **PITCH ON/OFF BUTTON** - This button is used to turn the PITCH SLIDER function on and off.
13. **4%,8%,16%,100% PITCH SELECT BUTTON** - Press the button in order to change pitch percentage of 4%,8%,16%,100%.
14. **BANK BUTTONS** - Press the desired BANK button when the MEMORY LED is lit will set the memory mode. The music from the cue point will be memorized to the flash. Press the desired BANK button when the SAMPLER LED is lit will set the sampler mode. The sampler length is determined by the smaller one of out point and bank length. Press the desired BANK button will return to the start point instantly. The LED of the BANK button last pressed will be flashing.
15. **PITCH SLIDER** - This slider is used to adjust the playback pitch percentage. The slider is a set adjustment and will remain set until the pitch slider is move or the pitch function has been turned off.
16. **TIME BUTTON** - The TIME button will switch the time value described in the time meter between elapsed play time, track remaining time, and total remaining time.
17. **SGL/CTN BUTTON** - This function allows you to choose between single track play or continuous track play (all tracks in order).
18. **PITCH +/- BUTTONS** - The desired pitch of CD decrease or increase when button is pressing and returns to the original pitch when the button is released.
19. **JOG WHEEL** - This wheel has two functions:
 1. The jog wheel will act as a frame search control when the CD in the pause or cue mode, allowing you to set a point.
 2. The wheel also works as a pitch bend during playback. Turning the wheel clockwise will increase the pitch percentage up to 100%, and turning the wheel in the counter-clockwise direction will decrease the pitch percentage down to -100%. The pitch bend will be determined on how long you turn the jog wheel continuously.
20. **CD LED** - This LED is illuminated when the CD tray is empty.

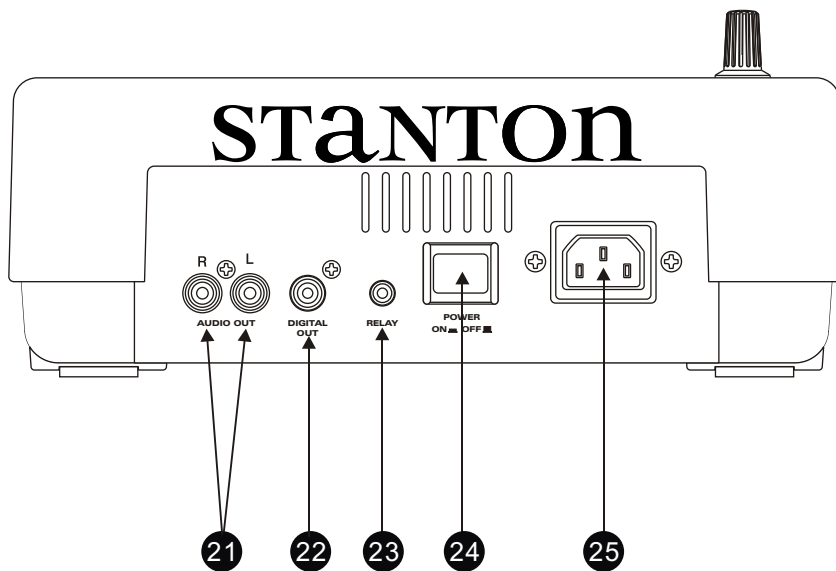

- 21. AUDIO OUT-SOCKETS** - This analogue signal requires RCA (left & right) connections. Connect this output to the respective input of your mixer (Line/Aux).
- 22. DIGITAL OUT-SOCKET** - This digital signal requires one SP/DIF (75 Ohm) connection. Connect this output to the respective input of your mixer / computer.
- 23. RELAY SOCKET** - Via the RELAY SOCKET, two CD players can be linked (connected) for relay play. If you connect to a mixer which supports fader start, you can also relay play via mixer's cross-fader.

- 24. POWER SWITCH** - Press this button to activate the unit.(i.e. Power ON/OFF)
- 25. AC CONNECTION** - Plug in the power supply cable here.

LCD Display

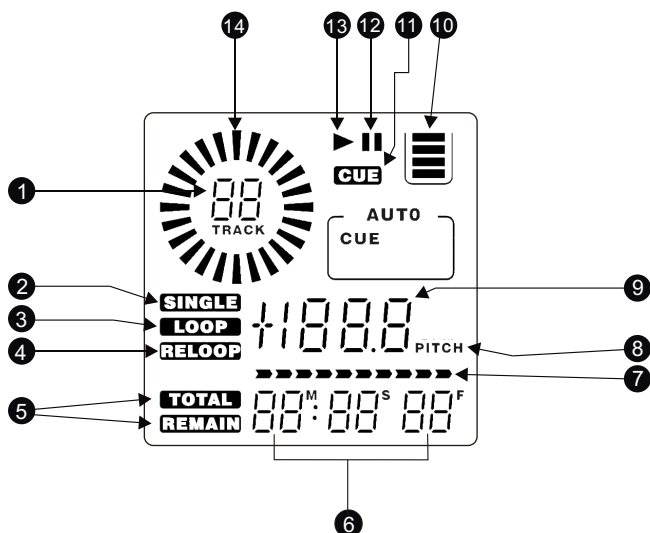

- 1. TRACK** - Shows the current track selected / playing.
- 2. SINGLE** - Shows when the unit is set to play just one track at a time. When this is not lit the CD will play continuously through all tracks. The function is controlled by the **SGL/CTN** button.
- 3. LOOP** - Shows when the CD is in LOOP mode; repeating a particular area of music on the CD.
- 4. RELOOP** - Shows when the CD has had a loop set previously and that the loop is ready to be played again.

- 5. ELAPSED, TOTAL REMAIN** - Indicates the time shown on the display is either ELAPSED, TOTAL REMAINING or the single song remaining time.
- 6. MINUTE, SECOND, FRAME** - Displays the time of track(s) currently selected in increments of Minutes, Seconds, and Frames.
- 7. TIME BAR** - Shows either time remaining or elapsed depending on the setting of the **TIME** button.
- 8. PITCH** - Indicator light to show when pitch is displayed.
- 9. PITCH** - Shows the numerical percentage of the song.
- 10. ANTI SHOCK AND BUFFER INDICATOR** - Indicates the current status of the Buffer Memory. This is represented on the display by a bucket being filled or emptied. The bucket itself represents the instant start function (which works by buffer memory). If the bucket is flashing, the instant start is not available. Each bar within the bucket represents 2 seconds of anti shock protection. There is up to 10 seconds of anti shock available.
- 11. CUE** - Indicates the unit is at a cue point and is ready to play.
- 12. PAUSE** - Indicates the unit is in CUE/ PAUSE mode.
- 13. PLAY** - Indicates the unit is currently playing a CD.
- 14. WHEEL INDICATOR** - A visual representation of a vinyl marker, indicating play position in frames. This wheel rotates during playback and stops during pause and also indicates direction (fwd/rev).

Set-up

1. Checking the Contents

Check the carton and packaging contents for the following items:

1. Tabletop unit
2. Operating instructions
3. One RCA cable.
4. One AC power cord.

2. Installing the Unit

1. Place your unit on a flat leveled surface.
2. Be sure the player is in a well-ventilated area where it will not be exposed to direct sunlight, high temperatures, or high humidity.
3. Try to place the unit as far as possible from TVs and tuners, as the unit may cause undesirable interference.

CAUTION:

- The player will work normally when the unit is within 15 degrees of the vertical plane. If the unit is tilted excessively, discs may not be loaded or unloaded properly.
- The unit panel's LCD's are designed to be clearly visible within the angles shown in Figure 1. Place the unit panel so that the visual angle is within this range.

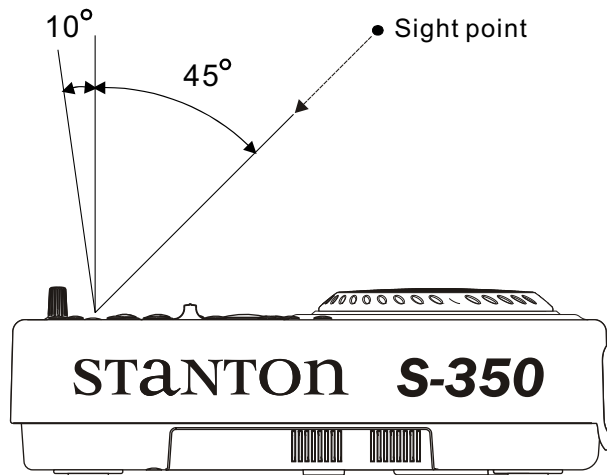

Figure 1

3. Connections

1. Make sure the unit is NOT powered on.
2. Connect the RCA pin cord to the input on your mixer.

CAUTION:

- Be sure to use the supplied cables. Using other types of cable may result in unit damage.
- To avoid sever damage to the unit, be sure the power is OFF when connecting the unit.

Operating instructions

1. Opening and Closing

This operation only works when the power is on.

Press the OPEN/CLOSE button to open or close the disc tray, or press PLAY button, the disc tray automatically closes.

If tray is not closed after 60 seconds it will close automatically and pause.

The disc tray cannot be opened during playback to prevent playback from being interrupted if the OPEN/CLOSE button is pressed accidentally. Stop playback, then press the OPEN/CLOSE button.

2. Loading Disc

Hold the disc by the edges and place it on the disc tray. Do not touch the single surface (the glossy side).

CAUTION:

Do not play foreign objects on the disc tray, and do not place more than one disc on the disc tray at a time. Doing so may result in malfunction.

Do not push the disc tray in manually when the power is off, as this may result in malfunction and damage the player.

3. Selecting Tracks

Select desired track by pressing the TRACK SEARCH Buttons once to move to one higher or lower track or hold the TRACK buttons down to change tracks continuously at a higher speed.

When a new track is selected during playback, playback begins as soon as the search operation is completed.

4. Starting Playback

Press the PLAY/PAUSE button during the pause or cue to start playback.

The PLAY indicator lights when playback starts.

5. Stopping Playback

There are two ways to stop playback.

1) Press the PLAY/PAUSE button during playback to pause at that point

2) Press the CUE button during playback to return to the position at which playback started (Back Cue).

6. Pausing

Press the PLAY/PAUSE button to switch between play and pause.

The PAUSE indicator lights when the pause mode is set.

7. Cueing

"Cueing" is the action of preparing for playback; when the Cue button is pressed, playback return to the cue point and enters pause mode. When the PLAY/PAUSE button is pressed during the cue mode, playback starts.

Cue point setting:

A. Playback starts from pause (using the jog wheel to set the start point) or skips to a new track during play or pause.

The beginning play point will be set to the cue point.

Or

B. Press the IN/R.CUE button during playback to set the new cue point ("CUE on the fly").

To return to Cue point press Cue Button. This will return to point A or B above.

The player has completed the cue or pause operation and is waiting for the play start command.

When the PLAY/PAUSE button is pressed, playback starts.

C. To memory cues.

8. Auto Cue

When disk is loaded, the cue point is set to the first

source of music.

If track is changed before pressing play, the cue point is changed to the new starting point.

If you pause during playback this also sets the new cue point.

9. Frame Search

This is done by first pausing then using the jog wheel to set the starting point. (When you use the jog wheel the monitor function allows you to hear what is playing.) Once you reach your desired starting point, you can set a cue (starting) point by pressing PLAY/PAUSE button.

10. Scanning (fast forward/fast reverse)

To turn the search wheel forward or reverse will give you a fast search through a disc or track. You will scan forward or reverse at 4 different speeds depending on how much you turn the wheel.

11. Loop Play

You can create a seamless loop between two points continuously.

a- Press PLAY/PAUSE button so a CD is playing.

The PLAY/PAUSE button's LED lights (figure 1).

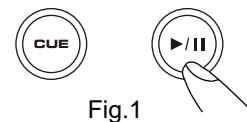

Fig.1

b- Press IN/R.CUE button. This sets the starting point of the SEAMLESS LOOP. The IN/R.CUE button LED will light (figure 2).

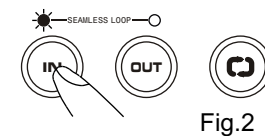

Fig.2

c- Press OUT/EXIT button to set desired ending point of the SEAMLESS LOOP. You will know you are in SEAMLESS LOOP mode because IN/R.CUE and OUT/EXIT LED will light and flash. LOOP INDICATOR in LCD DISPLAY will also flash. Sound will continue with no interruption (SEAMLESS LOOP)(figure 3).

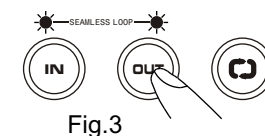

Fig.3

d- To exit SEAMLESS LOOP, press OUT/EXIT button. LED will stay on but not flash. Music will resume normal play (figure 4).

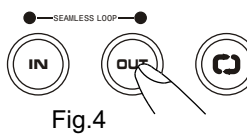

Fig.4

e- To replay loop, press the RELOOP button. IN/R.CUE and OUT/EXIT LED and LOOP INDICATOR in LCD DISPLAY will all begin flashing again (figure 5).

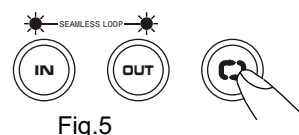

Fig.5

Operating instructions

12. Seamless Loop Play (Cont.)

- a- (Must be in SEAMLESS LOOP mode). If a SEAMLESS LOOP has not been created, follow instructions on this page for creating a SEAMLESS LOOP. If a SEAMLESS LOOP has already been created, press RELOOP BUTTON to reenter the SEAMLESS LOOP mode.
- b- Next, press OUT/EXIT BUTTON to return to normal play (figure 6). This disengages the SEAMLESS LOOP mode.

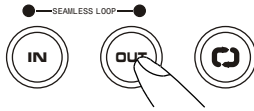

Fig.6

- c- Press OUT/EXIT button again for new desired ending point of the loop (figure 7).

FOR SHORTER LOOP: press OUT/EXIT button quickly.

FOR LONGER LOOP: Wait until the song plays several frames, then press OUT/EXIT button.

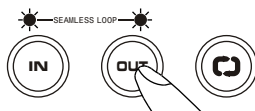

Fig.7

13. Time Display

During normal play, each time you press TIME button, the display changes as following information of elapsed, remain and total remaining time.

14. Pitch Bending

The speed increases or decreases respectively while the PITCH BEND+ or PITCH BEND- button is pressed. The extent to which the speed change is proportionate to the amount of time the button is pressed. For example, if the PITCH BEND+ button is held in continuously, the speed increases continuously. The pitch changes within the range of +/- pitch select.

The jog wheel will temporarily bend the pitch of the music if the song is already playing by rotating the wheel clockwise to speed up or counterclockwise to slowdown. The speed that you rotate the JOG Wheel determines the percent of pitch bend.

15. Memory Cueing (setting a cue point)

- Press the MEMORY button to make the unit enter cue memory mode (LED on), then press the desired BANK button at the desired cue point to memorize. A new cue point will be set. The numeral on the display will flash twice then lit steadily to indicate the cue memory has been set.

16. Recall Cue Point

- Press the MEMORY button to make the unit enter cue recall mode (LED off), then press the desired BANK button to recall the desired cue memory point, during playback or pause mode accessing a stored cue point will cue to that point and instantly start without any music interruption. The last cue that was stored or recalled will flash in the LCD screen to let you know it was last cued

17. Memory Backup

This will automatically keep your last setting (SGL, CTN) even if you unplug AC current.

18. Fader Start Playback

Both player's CONTROL jack are connected to Mixer's CROSS FADER signal output CH1 or CH2; when the

jack are connected, the operation for both player as following:

Left player will return to standby mode at CUE point automatically when move CROSS FADER from left to right to start playback on right player.

Right player will return to standby mode at CUE point automatically when move CROSS FADER from right to left to start playback on left player.

19. Relay Play Using Two Players

How to set the Relay function:

When the both players' CONTROL jacks are connected to each other, the relay-play FX can be produced. The relay play is explained as below.

- Set both players to single play mode (the SINGLE indicators will lit in the displays).
- Begin playback on the first player.
- When the currently playing track ends, playback will begin automatically on the standby player.
- The first player will enter standby mode at the beginning of the next track on its disc.
- By repeating this operation, the two players can be used to perform continuous relay play.
- By loading new discs on the standby player, you can construct a continuous program of whatever tracks you wish.
- By setting a cue point on the standby player, you can perform relay to any desired cue point on the selected track.

NOTE:

- Relay play may not work properly if audio out jacks on the two players are not connected to the same audio signal/amplifier.**

20. Stutter Effect

It can create a sound similar to a CD skipping. The STUTTER Effect can be created in 2 ways.

- By rapidly pressing the CUE button
 - Press PLAY/PAUSE button so that music is playing. PLAY/PAUSE LED will light (figure 8).



Fig.8

- Next, rapidly press the CUE button in sync with the music (figure 9).



Fig.9

- By rapidly pressing the BANK1 or BANK 2 or BANK 3 or BANK4 buttons

21. Sleep Mode

The CD player automatically shuts off the transport and laser after 15 minutes (when in pause or cue mode). This will lengthen the life of your motor drive and laser. To restart player, just press cue, PLAY/PAUSE buttons.

Specifications

1. APPLICATION Model S-350
2. POWER SOURCE AC 230V, 50Hz, 14W
3. DIMENSIONS 348 (W)x 246 (D)x 106 (H) mm
4. WEIGHT 3 Kgs

5. CHARACTERISTICS (TEST DISC: TCD-782, LOAD=47Kohm)

ITEM	TYPICAL	LIMIT	CONDITION
(1) Output level	1Vrms+/-0.5dB	1Vrms+/-1dB	1KHz,0dB
(2) Channel balance	within 0.5dB	within 1dB	1KHz,0dB
(3) Frequency response	20-20KHz,+/-0.5dB	20-20KHz,+/-1dB	0dB output
(4) De-emphasis response	+/-2.5dB	+/-3dB	16KHz,-20dB
(5) Channel separation	83dB	75dB	1KHz,0dB
(6) T.H.D. + NOISE*1	0.01%	0.03%	1KHz,0dB
(7) S/N ratio*2	86dB	80dB	1KHz,0dB

NOTE: *1 With 20KHz low pass filter.

*2 With 20KHz low pass filter, " IHF-A" weighted.

6. SEARCHING TIME (TEST DISC: TCD-792)

ITEM	TYPICAL	LIMITS	CONDITION
(1) Short access time	2sec	4sec	Play next track
(2) Long access time	4sec	6sec	Track 1 ->Track 20 Track 20 ->Track 1

7. PLAYABILITY

ITEM	TYPICAL	LIMIT	CONDITION
(1) Interruption	1mm	0.7mm	TCD-725
(2) Black dot	1mm	0.6mm	TCD-725
(3) Finger prints	75um	65um	TCD-725
(4) Eccentricity	140um	140um	TCD-712 W/O TRACK JUMP
(5) Vertical deviation	1mm	0.5mm	TCD-731R

8. PICK-UP

(1) System	Object lens drive system optical pick-up
(2) Object lens drive system	2 dimensional paralalled drive
(3) Tracking detection	3 spot beam detection
(4) Optical source	Semiconductor laser
(5) Wave length	780nm

9. GENERAL

(1) System	Compact Disc Digital Audio
(2) Disc loading	Front loading
(3) Display	LCD
(4) Pitch control range	Within +/-4%, +/-8%, +/-16%, +/-100%
(5) Pitch bend	+/-100%
(6) Pitch accuracy	0.1 %

10. ENVIRONMENTAL

ITEM	CONDITION
(1) Operating Temperature	5 to 35 deg. C
(2) Humidity	25 to 85% RH (non-condensing)
(3) Storage Temperature	-20 to 60 deg. C

11. ACCESSORIES

(1) Connected RCA cable	1 set for L and R channel
(2) Operating Instruction	1 pc
(3) Auto-start cable	1 pc

12. NOTES

- (1) The specifications are subject to change to any improvement by negotiations in advance.
- (2) The parts are subject to change to any improvement within the range of the specifications.

Free Manuals Download Website

<http://myh66.com>

<http://usermanuals.us>

<http://www.somanuals.com>

<http://www.4manuals.cc>

<http://www.manual-lib.com>

<http://www.404manual.com>

<http://www.luxmanual.com>

<http://aubethermostatmanual.com>

Golf course search by state

<http://golfingnear.com>

Email search by domain

<http://emailbydomain.com>

Auto manuals search

<http://auto.somanuals.com>

TV manuals search

<http://tv.somanuals.com>