

stanton

A.900 / A.1800 / A.2800 HEAVY DUTY PROFESSIONAL AMPLIFIERS

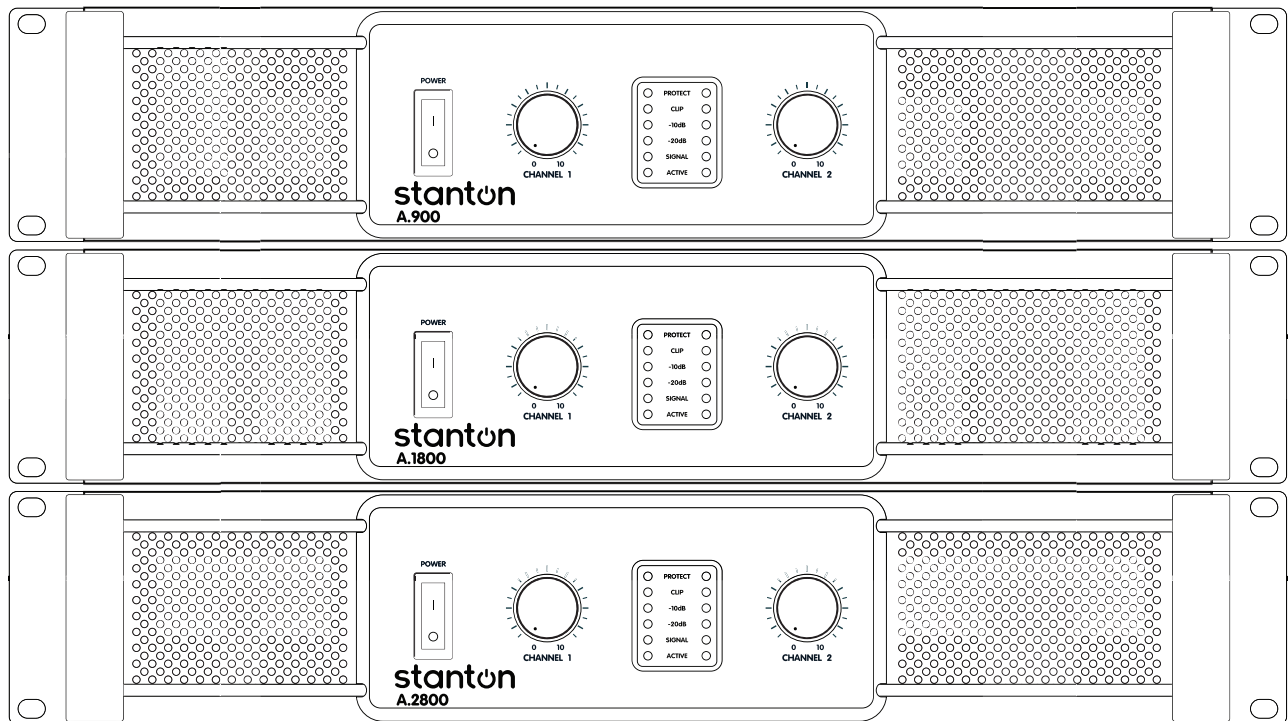

USER MANUAL

IMPORTANT SAFETY INSTRUCTIONS

1. Read Instructions – All the safety and operating instructions should be read before this product is operated.
2. Retain Instructions – The safety and operating instructions should be retained for future reference.
3. Heed Warnings – All warnings on the appliance and in the operating instructions should be adhered to.
4. Follow Instructions – All operating and use instructions should be followed.
5. Water and Moisture – The appliance should not be used near water - for example, near a bathtub, washbowl, kitchen sink, laundry tub, in a wet basement, or near a swimming pool, and the like.
6. Wall or Ceiling Mounting – The product should be mounted to a wall or ceiling only as recommended by the manufacturer.
7. Heat – Appliance should be situated away from heat sources such as radiators, heat registers, stoves, or other appliances (including amplifiers) that produce heat.
8. Power Sources – This product should be operated only from the type of power source indicated on the rating label. If you are not sure of the type of power supply to your home, consult your product dealer or local power company. For products intended to operate from battery power, or other sources, refer the operating instructions.
9. Grounding or Polarization – This product may be equipped with a polarized alternation-current line plug (a plug having one blade wider than the other). This plug will fit into the power outlet only one way. This is a safety feature. If you are unable to insert the plug fully into the outlet, try reversing the plug. If the plug should still fail to fit, contact your electrician to replace your obsolete outlet. Do not defeat the safety purpose of the polarized plug.
10. Power-Cord Protection –Power-supply cords should be routed so that they are not likely to be walked on or pinched by items placed upon or against them, paying particular attention to the cord in correspondence of plugs, convenience receptacles, and the point where they exit from the appliance.
11. Cleaning - The appliance should be cleaned only as recommended by the manufacturer. Clean by wiping with a cloth slightly damp with water. Avoid getting water inside the appliance.
12. For AC line powered units - Before returning repaired unit to user, use an ohmmeter to measure from both AC plug blades to all exposed metallic parts. The resistance should be more than 100,000 ohms
13. Non-use Periods –The power cord of the appliance should be unplugged from the outlet when left unused for a long period of time.
14. Object and Liquid Entry – Care should be taken so that objects do not fall and liquids are not spilled into the enclosure through openings
15. Damage Requiring Service – The appliance should be serviced by qualified service personnel when:
 - A. The power-supply cord or the plug has been damaged; or
 - B. Objects have fallen, or liquid has been spilled into the appliance; or
 - C. The appliance has been exposed to rain; or
 - D. The appliance does not appear to operate normally or exhibits a marked change in performance; or
 - E. The appliance has been dropped, or the enclosure is damaged.
16. Servicing –Do not attempt any service to the appliance beyond that described in the operating instructions. All other servicing should be referred to qualified service personnel.
17. Ventilation – Slots and openings in the cabinet are provided for ventilation and to ensure reliable operation of the product and to protect it from overheating, and these openings must not be blocked or covered. The openings should never be blocked by placing the product on a bed, sofa, rug, or other similar surface. This product should not be placed in a built-in installation such as a bookcase or rack unless proper ventilation is the manufacturer's instructions have been adhered to.
18. Attachments – do not use attachments not recommended by the product manufacturer as they may cause hazards.
19. Accessories – Do not place this product on an unstable cart, stand, tripod, bracket, or table. The product may fall, causing serious injury to a child or adult, and serious damage to the product. Use only with a cart, stand, tripod, bracket, or table recommended by the manufacturer, or sold with the product. Any mounting of the product should follow the manufacturer's instructions, and should use a mounting accessory recommended by the manufacturer.
20. Lightning – For added protection for this product during a lightning storm, or when it is left unattended and unused for long periods of time, unplug it from the wall outlet and disconnect the antenna or cable system. This will prevent damage to the product due to lightning and power-line surges.
21. Replacement Parts – When replacement parts are required, be sure the service technician has used replacement parts specified by the manufacturer or have the same characteristics as the original part. Unauthorized substitutions may result in fire, electric shock, or other hazards.
22. Safety Check – Upon completion of any service or repairs to this product, ask the service technician to perform safety checks to determine that the product is in proper operating condition.
23. This product is in compliance with EU WEEE regulations. Disposal of end of life product should not be treated as municipal waste. Please refer to your local regulations for instructions on proper disposal of this product.
24. Carts and Stands – The appliance should be used only with a cart or stand that is recommended by the manufacturer. An appliance and cart combination should be moved with care. Quick stops, excessive force, and uneven surfaces may cause the appliance and cart combination to overturn.
25. This device complies with Part 15 of the FCC Rules. Operation is subject to the following two conditions: (1) this device may not cause harmful interference, and (2) this device must accept any interference received, including interference that may cause undesired operation.”



CAUTION
RISK OF ELECTRIC SHOCK
DO NOT OPEN



CAUTION: To reduce the risk of electric shock, do not remove any cover. No user-serviceable parts inside. Refer servicing to qualified service personnel only.



The lightning flash with arrowhead symbol within the equilateral triangle is intended to alert the user to the presence of un-insulated “dangerous voltage” within the product’s enclosure that may be of sufficient magnitude to constitute a risk of electric shock.



The exclamation point within the equilateral triangle is intended to alert the user to the presence of important operation and maintenance (servicing) instructions in the literature accompanying this appliance.

CAUTION: To prevent electric shock, do not use this polarized plug with an extension cord, receptacle or other outlet unless the blades can be fully inserted to prevent blade exposure.

INTRODUCTION

Thank you for your decision to purchase Stanton's innovative new A Series professional power amplifier! Engineered for superior sound reproduction, the A Series line of professional amplifiers deliver top quality audio at an affordable price. The A Series offer a standard of reliability and efficiency that makes them the perfect solution for every DJ, musician, and sound engineer. Welcome to a new level of professional quality sound performance!

UNPACKING & INSTALLATION

Although it is neither complicated to install, nor difficult to operate your amplifier, a few minutes of your time are required to read this manual for a properly wired installation, and to become familiar with the unit's features. Please take great care in unpacking the unit and do not discard the carton and other packing materials. They may be needed when moving the unit and are required if it ever becomes necessary to return the unit for service. Never place the unit near a radiator, in front of heating vents, in direct sunlight, in excessive humidity, or dusty locations to avoid damages and to guaranty a long reliable use. Connect the unit with the system components according to the description on the following pages.

FEATURES

- Stanton amplifiers deliver the following power ratings.
 - A.900 - 2 x 210 Watts at 8 ohm, 2 x 320 Watts at 4 ohm and 2 x 420 Watts at 2 ohm
 - A.1800 - 2 x 400 Watts at 8 ohm, 2 x 600 Watts at 4 ohm and 2 x 900 Watts at 2 ohm
 - A.2800 - 2 x 600 Watts at 8 ohm, 2 x 900 Watts at 4 ohm and 2 x 1400 Watts at 2 ohm
- 2-channel, parallel or bridged mono operating modes for flexible application 900 Watts for A.900, 1800 Watts for A.1800 and 2800 Watts for A.2800
- Independent limiters for each channel reduce distortion
- Independent input level controls for each channel allow precision adjustments
- Precise signal and clip LED indicators to monitor performance, allow you to correct for overloading (clipping) condition
- Low-frequency filters (40 Hz) remove rumble and subsonic frequencies
- Twin-tunnel and two temperature-sensitivity forced-air cooling system to maintain a low operating temperature during use
- Balanced XLR or balanced 1/4-inch TRS Combination input connector for each channel and LINK ports
- 5-way output binding posts or Speakon® connectors enable secure operation
- High-current toroidal transformer for absolute reliability
- Independent DC and thermal overload protection on each channel automatically protects amplifier and speaker from damage or failure
- The A-Series can be mounted in any standard 19" rack

FRONT PANEL CONTROLS

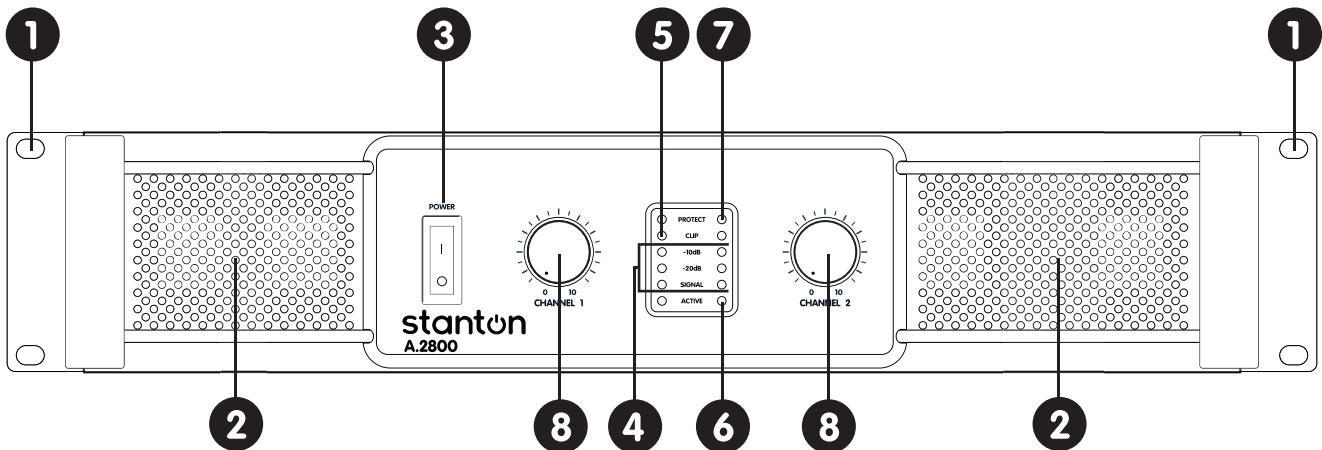

1. Rack Ears

These ears are used to mount the amplifier in any standard 19" rack.

2. Fan Vent

The A-Series amplifiers are cooled by two rear-mounted fans (except for A.900 which is cooled by a single rear mounted fan). Cool air flows through the front fan filters, reducing the temperature internal components while forcing the heat out the rear vents. Never block these vents and keep them clean at all time.

3. AC Power Switch

This switch powers the unit on and off.

4. Signal Indicators

These blue LED's will illuminate to indicate that a signal is present at the amplifier input, and that the signal is being amplified.

5. Clip Indicators

These red LED's will illuminate at the clipping threshold. These lights should not light up during normal use as they indicate signal outside of the amplification range of the amplifier. When a signal is "clipped" and the clip indicator illuminates, it means that the signal is being distorted at the output stage. Prolonged clipping can not only damage your amplifier, but also your speakers, so be careful to monitor the clip indicator during setup and use. If the clip indicator is illuminated then simply lower the channel gain or input signal until the indicator does not light.

6. Active Indicators

These blue LED's indicate that AC power is connected and the amplifier is turned on.

7. Protect Indicators

These red LED's indicate that the channel is in Protect mode. When the channel goes into protect mode all output for that channel will be muted. The protect LED's light when overheating or other severe problems occur. This is to protect any speakers connected to the channel. The LED's also light for approximately five seconds whenever the unit is powered on and fade slowly when the amplifier is powered off.

8. Channel input level control

These two 21-position detented potentiometers adjust input level for their respective amplifier channels. In Bridged Mono Mode, only channel 1 level control are used to adjust signal level. In Parallel Mode, both input level control are used to adjust signal level for their respective amplifier channels. At their fully counter-clockwise position, the signal is attenuated by more than 80dB. At their fully clockwise position, the signal is at unity gain. When 0 dBu of signal arrives at the input jacks and the Channel input level controls are set to their fully clockwise position, the unit delivers full power output.

REAR PANEL CONTROLS

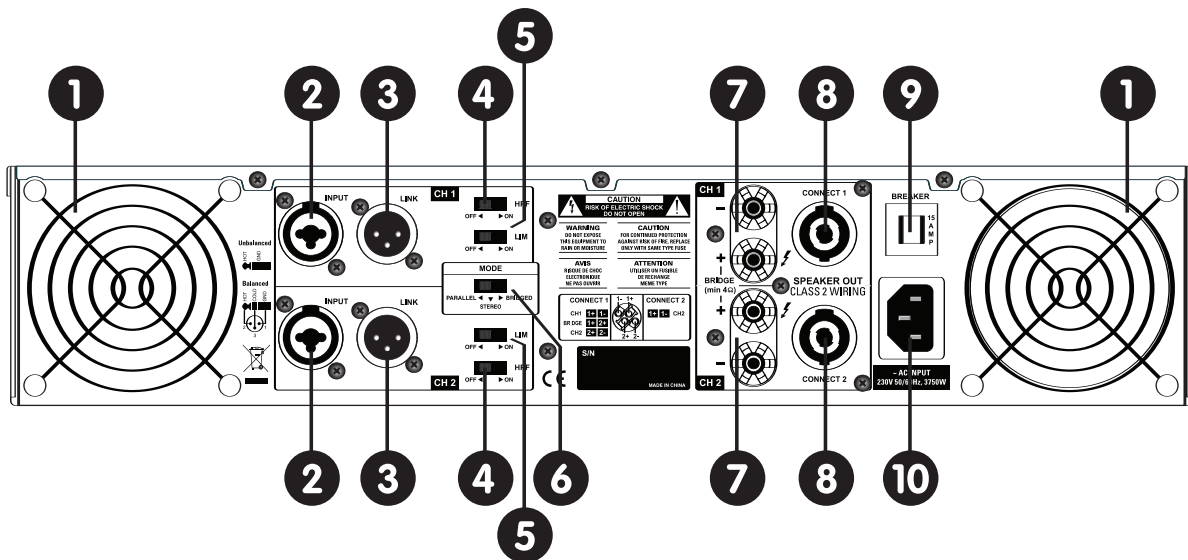

1. Fan

This is a variable speed cooling fan. Cool air enters the amplifier through the fan filters located on the front of the amplifier. Be sure not to block these ports when installing the amplifier or other equipment.

2. Input connectors

Connect the input source to the balanced combo connectors using either XLR or 1/4" TRS plugs. They are configured as follows: Pin 2 (Tip) hot, Pin 3 (Ring) cold, and Pin 1 (Sleeve) ground. We recommend using balanced three-conductor cabling wherever possible. Unbalanced two-conductor 1/4" plugs can also be inserted into these inputs, but you will get better signal quality and less outside noise and hum if you use balanced lines. Stereo signal should be connected to both the Channel 1 and Channel 2 input jacks. When operating the unit in Bridged Mono or Parallel modes, use the Channel 1 input jack only.

3. Link connectors

These jacks are used to send a parallel signal to another device or amplifier.

4. High Pass Filter (HPF) switch.

These switches are used to activate the built-in High Pass Filter. The HPF rolls off signals below 40Hz. This improves bass performance by limiting sub-audio cone motion, making more power available for the speaker's rated frequency range. When the filter is turned off, a 5 Hz roll off protects against DC or deep sub-audio inputs.

5. Limiter switch

When the input signal connected to your amplifier is too high, you end up with a distorted output signal. To prevent this, both channels feature a clip limiter that can be engaged or disengaged selectively.

6. Bridge / Stereo / Parallel switch

This switch changes the amplifier operating mode between stereo, mono bridged, and parallel.

7. 5-way Binding Post

Connect each channel of the unit to 4 ohms or 8 ohms loudspeakers. Two pairs of 5-way binding posts are provided for each channel, so that paralleling of speakers is possible. Connection to the binding posts can be made with bare wire, banana plugs, or spade lug terminations. Make connections to both the Channel 1 and Channel 2 terminals for Stereo or Parallel Mode, or a single connection across the red terminals only of Channel 1 and Channel 2 for Bridged Mono Mode.

8. Speakon® output connectors

You can use these to connect each channel of the unit to 8 ohms or 4 ohms loudspeakers. Using Speakon® speaker cables, make connections to both the channel 1 and channel 2 connectors for Stereo or Parallel Mode, or to the Bridged mode connector for Bridged Mono Mode.

9. Circuit breaker

The breaker acts in place of common disposable fuses. This circuit breaker will trip if there is a fault with the main voltage or if maximum output is exceeded. Simply depress the circuit breaker and power up the unit again.

10. AC input

IEC connector for AC power cable. Connect the supplied heavy-gauge 3-pin IEC power cable.

PROTECTION

Every model in the A-Series incorporates protection features. The front panel Protection LED indicates the activity of the relay speaker connection circuitry in each channel. When the protection LED turns on, this circuitry is active, and all connected speakers are muted.

Initial power-up : For approximately five seconds after initial power-up, the protection circuitry is activated and the speaker outputs are muted. If everything is operating normally, you will hear an audible click at the conclusion of this brief period, as the protection circuitry is deactivated and the unit begins delivering signal to the connected speakers. It is normal for the Protection LED to fade gradually after the amplifier is powered off.

Thermal Protection : Abnormally high heat sink temperatures will engage the protection circuitry for the overheating channel only. An output relay disconnects the speakers until normal temperature range is restored. The Protect indicator will light to show the protection circuit is active. To guard against this problem, make sure the unit receives adequate ventilation on all sides and that both the front and rear panels are unobstructed. If the power transformer gets too hot, its thermal switch will disconnect all of the secondary power and disconnect both channel outputs.

Short circuit : If output is shorted due to faulty wiring, the thermal circuitry will automatically protect the amplifier. If this occurs, the load will be disconnected by thermal protection circuitry.

DC Voltage Protection : If an amplifier channel detects DC voltage at the speaker output, the output relay will immediately open to prevent speaker damage.

Subsonic Frequency Protection : The built-in High Pass Filter provides subsonic frequency protection for each channel.

Current limiting Protection : At the amplifier's full power limit, or clipping point, the limiter circuitry will be activated. This is indicated by illumination of the Clip LED. The channel gain is automatically reduced, protecting the speakers from high power. Uncontrolled feedback, oscillations, or improper equipment gain setting may activate this circuitry, which is virtually transparent in operation as full signal bandwidth is maintained.

There is reason to be concerned any time the Protection LED lights up (except for initial power-up during approximately five seconds). If this occurs, turn the amplifier off immediately and check all wiring and external equipment carefully in order to locate and correct the condition.

SETUP

Clip limiter



Clipping is the result of an amplifier running into power supply limitation. The maximum output voltage that any amplifier can produce is limited by its power supply. Attempting to output a voltage (or current) level that exceeds the power supply limit will result in a flattening effect on the signal. A clipped waveform exhibits extreme harmonic distortion, making it sound harsh or dissonant. The clip limiter detects this and reduces the gain to minimize the amount of overdrive. To preserve as much of the program dynamics as possible, limiting reduces the average program level until peaks barely clip. Each channel has its own clip limiter, which can be switched on or off. When driving full-range speakers, clip limiting reduces high frequency distortion caused by bass overload. It also protects higher frequency drivers from excess overdrive and harsh clipping harmonics.

HPF (Hi-Pass Filter)

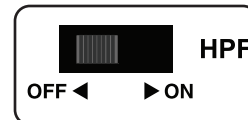

Also known as a low-cut filter, a High Pass Filter rolls off signals below 40Hz. The reproduction of the signal's bass portion is thus optimized, since ultra-low, distracting frequencies are eliminated, and more power is available for the reproduction of the wanted segment of the signal.

You should set up the filters so they best suit the frequency response of your speakers, since some speakers are particularly sensitive to over-excursion. The 40Hz filter works well with most compact full-range speakers.

SETUP

Mode Select

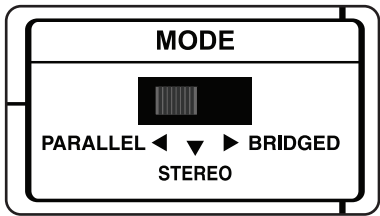

Stereo Mode

In stereo mode, both channels operate independently with individual input gain controls. Signal at channel 1's input produces output at channel 1, while signal at channel 2's input produces output at channel 2's output. Recommended minimum nominal load impedance for stereo operation is 2 ohms per channel.

Parallel Mode

When set to Parallel mode, a signal applied to channel 1's input will be amplified and appear at outputs for both channel 1 & 2. The parallel mode is well suited for applications in which driving two speakers with the same signal but with separate amplification.

Bridged Mono Mode

Bridged mono mode straps both amplifier channels together to make a very powerful, single-channel monaural amplifier. One channel "pushes" and the other channel "pulls" equally, doubling the power over that of either channel alone. Therefore the voltage is doubled, the peak power is quadrupled, and program power is roughly three times as high as that of the individual channel.

Signal is applied to the channel 1 input only and channel 1 input gain control is used to adjust signal level. The input gain control belonging to channel 2 are not used.

Note : Bridged mono mode is to be used only when the A-Series is connected to a 4 or 8 ohms speaker load. Use of Bridged mode with speaker loads of 4 ohms or less can result in severe damage to the unit due to excessive heat and current limiting.



Use extreme caution when operating the amplifier in Bridged Mono Mode. Never ground either side of the speaker cable; the speaker load must "float" away from the amplifier chassis.

CONNECTIONS

Stereo Mode

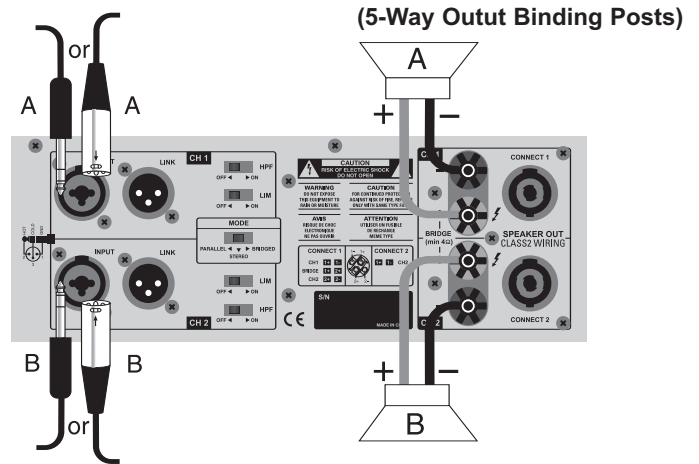

Parallel Mode

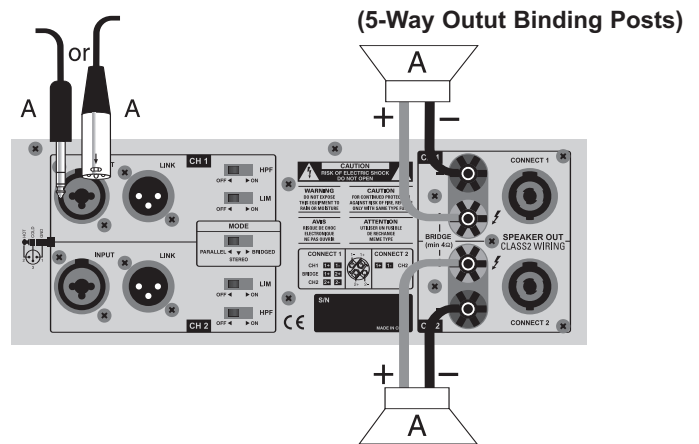

Bridged Mono Mode

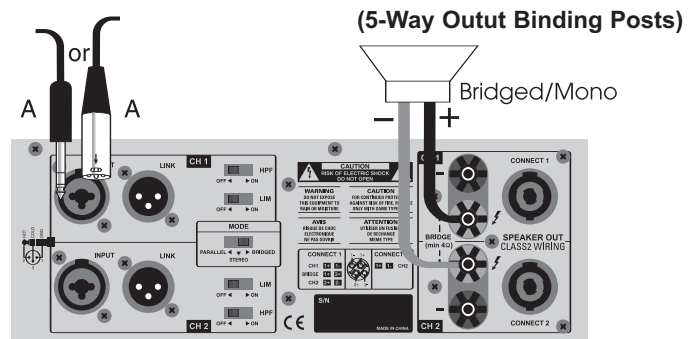

CONNECTIONS

Stereo Mode

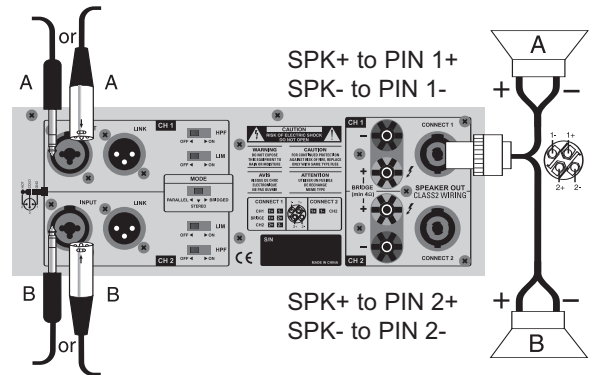
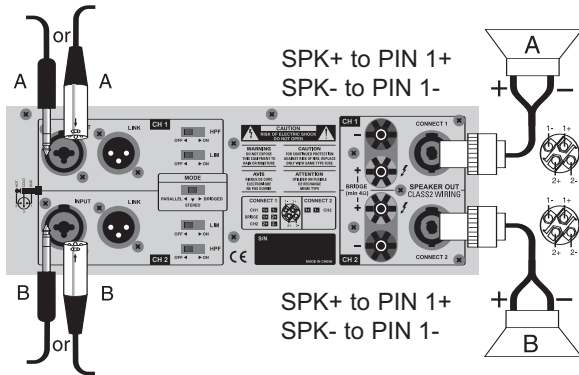

Parallel Mode

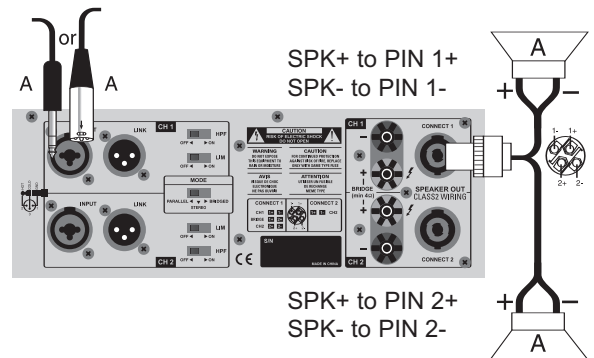
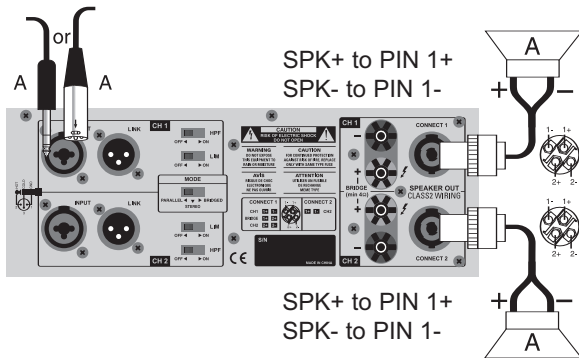

Bridged Mono Mode

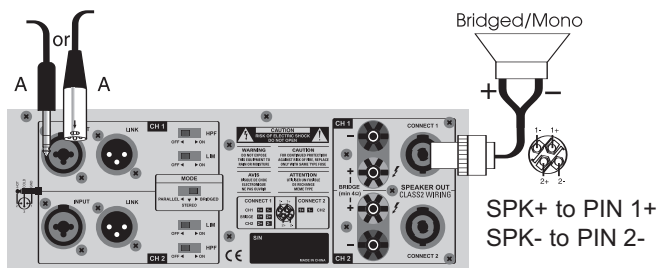

WIRING

These are several ways to interface the amplifier to support a variety of applications.

Unbalanced 1/4" Connector

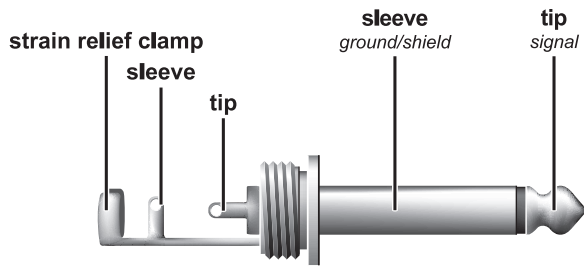

Unbalanced 1/4" Connector

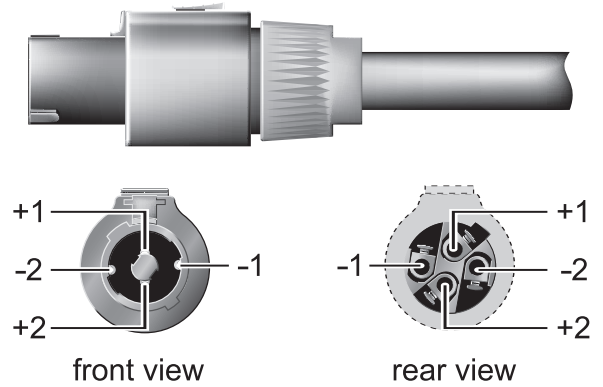

Balanced TRS 1/4" Connector

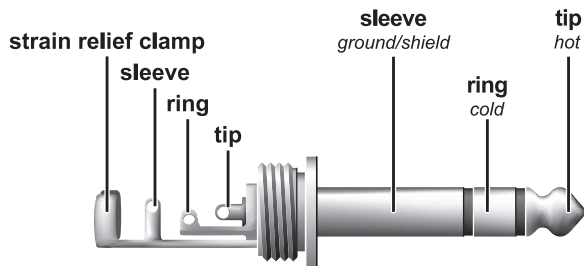

For connection of balanced and unbalanced plugs, ring and sleeve have to be bridged at the stereo plug.

XLR Balanced Wiring Guide

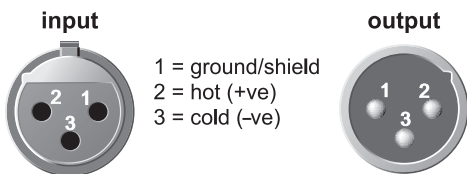

For unbalanced use pin 1 and pin 3 have to be bridged

SPECIFICATIONS

	A.900	A.1800	A.2800
Rated Output Power	Stereo Both Channel Driven		
8 ohms	210 W	400 W	600 W
4 ohms	320 W	600 W	900 W
2 ohms	420 W	900 W	1400 W
Rated Output Power	Bridged Mono		
8 ohms	650 W	1200 W	1800 W
4 ohms	845 W	1800 W	2800 W
Signal to Noise Ratio (20 Hz ~ 20k Hz)	100dB	102dB	104dB
Distortion (SMPTE-IM)	0.05%	0.01%	0.04%
Input sensitivity @8 ohms	4dBu	4dBu	4dBu
Voltage Gain	30dB	33dB	35dB
Output Circuitry	AB	AB	H
Current Consumption	120Vac / 240Vac		
@ 1/8 power @4 ohms	4.5A / 2.2A	7.2A / 3.5A	8.5A / 4.1A
@ 1/3 power @4 ohms	7A / 3.6A	12A / 6A	17A / 8.3A
@ Rated power @4 ohms	10.5A / 5.5A	19.5A / 9.5A	32A / 16A
Distortion			
20 Hz-20k Hz Half Power	0.01%	0.01%	0.03%
1k Hz Rated Power	0.1%	0.1%	0.1%
Frequency Response	0/-0.5dB ; 20Hz-20KHz, 0/-3dB ; 5Hz-60KHz		
Damping Factor (400 Hz)	200	280	350
Input Impedance	15Kohm Unbalanced, 30Kohm Balanced		
Input Clipping	22dBu (10Vrms)		
Cooling	Continuously variable speed, Front to rear		
Connectors (each)			
Input	Active balanced combo (XLR and 1/4" TRS common use)		
Output	5-way Binding post and Speakon®		
Control			
Front	AC power switch, Channel 1 and 2 volume		
Rear	HPF switch, Limiter switch, Mode selector switch		
Indicators	Active(light blue), Protection(red), Clip(red), Signal (dark blue)		
Protection	Short circuit, Thermal, Current limit, DC offset, Current inrush, RF protection, Turn on / Turn off muting		
Power requirements	100v 50/60Hz(JP) 120V 60Hz(U.S.A. & Canada) 240V 50Hz(EU)		
Dimensions (W _ H _ D)	19"(482mm) _ 3.5"(88mm) _ 16.5"(420 mm)		
Net Weight	28 lb (12.6 kg)	40 lb (18 kg)	46 lb (20.7 kg)

SPEAKER COMPATIBILITY

The A Series of amplifiers are designed to work with many different speakers on the market. They have been paired with the following Cerwin-Vega speakers. The following compatibility matrix can be used as a reference. (See: www.cerwin-vega.com for product specs.)

Amp Compatibility Information with CV Speakers			
Speakers	Amp Model	Amp Mode	
Two INT-152s	A.1800	Stereo	
Two INT-252s	A.1800	Stereo	
Two 118S	A.2800	Stereo	
Two 118S	A.2800	Bridged	
Two 118S	A.1800	Bridged	
One 118S	A.900	Bridged	
Two INT-152s + Two 118S	A.2800	Stereo	one top + one sub per amp channel
One JE- or EL-36B	A.900	Bridged	
Two JE- or EL-36B	A.2800	Stereo	
Two JE- or EL-36B	A.1800	Bridged	
One AB-36B	A.1800	Bridged	
One AB-36B	A.1800	Bridged	
Two AB-36B	A.2800	Stereo	
Two INT-252s + Two EL or JE-36B	A.2800	Stereo	one top + one sub per amp channel
Two INT-252s + Two AB-36B	A.2800	Stereo	one top + one sub per amp channel
Two INT-152s + Two JE- or EL-36B	A.2800	Stereo	one top + one sub per amp channel
Two INT-152s + Two AB-36B	A.2800	Stereo	one top + one sub per amp channel
Two INT-252s + Two 118S	A.2800	Stereo	one top + one sub per amp channel
Four (2 per ch) INT-252s	A.1800	Stereo	two INT-252s per channel
Four (2 per ch) INT-152s	A.2800	Stereo	two INT-152s per channel
Four (2 per ch) INT-152s	A.1800	Stereo	two INT-152s per channel

WARRANTY & RETURN POLICY

Warranty

Through Stanton's authorized dealers around the World, Stanton, or one of Stanton's authorized distributors outside the U.S., will, without charge, repair or replace, at the sole discretion of the entity responsible for making the repair or providing the replacement, any Stanton merchandise proved defective in material or workmanship for a period of three (3) years following the date of original purchase.

Stanton will warrant all replacement parts and repairs for ninety (90) days from the date of original shipment. Repairs made necessary by reason of misuse, alteration, normal wear, or accident are not covered under this warranty.

Returns

Authorized Stanton dealers are only authorized to sell and distribute merchandise within a specific country. All goods requiring warranty repair or replacement must be returned (freight prepaid if not hand-delivered) to the authorized Stanton dealer from whom the merchandise was purchased and in the same country where the merchandise was purchased. For purposes of purchases made via the Internet, the merchandise must be returned to the authorized Stanton dealer in the country where the authorized Stanton dealer which sold the merchandise to purchaser is located and not the authorized Stanton dealer in the country where the purchaser is located or the country in which the merchandise was received. Any returns to a non-authorized dealer or to an authorized Stanton dealer not in the same country as the merchandise was intended to be sold or as set forth above will void this warranty.

To initiate a warranty repair, you must contact the authorized Stanton dealer from whom you purchased the merchandise, and follow such authorized Stanton dealer's return policy.

Stanton assumes no risk and shall be subject to no liability for damages or loss resulting from the specific use or application made of the merchandise. Stanton's liability for any claim, whether based on breach of contract, negligence, infringement of any rights of any party, or product liability, and relating to the merchandise shall not exceed the price received by Stanton from your purchase of such merchandise. In no event will Stanton be liable for any special, incidental or consequential damages (including loss of use, loss of profit and claims of third parties) however caused, whether by the negligence of Stanton or otherwise. To the extent permitted by law and except as otherwise provided above, Stanton disclaims any express or implied warranties of merchantability or fitness for a particular purpose.

The above warranty provides you with specific legal rights. You may also have additional rights, which are subject to variation from state to state and country to country.

If there is a dispute regarding the warranty of merchandise that does not fall under the warranty conditions stated above, please include a written explanation with the merchandise when returned pursuant to the terms and conditions set forth herein.

Please register your product online at www.stantondj.com or mail your completed warranty card to:

Stanton Magnetics, Inc, 3000 SW 42 St. Hollywood, Florida 33312.

STANTON WARRANTY REGISTRATION CARD

If you have internet access, please register your product at www.stantondj.com. Otherwise, return this card completely filled out in order to validate your warranty.

PERSONAL INFO

Name _____

Address _____

City _____ **State** _____ **Zip** _____

Country _____

Telephone _____ **eMail** _____

PRODUCT INFO

Model Number _____

Serial Number _____

Date of Purchase _____

Where did you buy this product? _____

cut along dotted line

PLACE
STAMP
HERE

Stanton Magnetics, Inc.
P.O. Box 816667
Hollywood, FL 33081
U.S.A.

Free Manuals Download Website

<http://myh66.com>

<http://usermanuals.us>

<http://www.somanuals.com>

<http://www.4manuals.cc>

<http://www.manual-lib.com>

<http://www.404manual.com>

<http://www.luxmanual.com>

<http://aubethermostatmanual.com>

Golf course search by state

<http://golfingnear.com>

Email search by domain

<http://emailbydomain.com>

Auto manuals search

<http://auto.somanuals.com>

TV manuals search

<http://tv.somanuals.com>