

Star Trac Fitness™
E-ST 5090 Stepper

OWNER'S MANUAL



TABLE OF CONTENTS

Introduction	4
About This Manual	4
Safety Instructions	5
Assembly and Setup	11
Unpacking and Assembly	11
Operating Instructions	15
Display Panel Features	15
Soft Trac®	16
Hints and Tips for Getting Started	16
Viewing Workout Data During a Program	16
Pause Mode	17
Cooldown Cycle	17
Using the Personal Fan	17
Heart Rate Monitoring	18
Quick Start	18
Preset Programs	19
Heart Rate Control Programs	23
Fitness Test	25
Preventive Maintenance	26
Daily Maintenance	26
Weekly Maintenance	26
Monthly Maintenance	26
Regulatory Information	27
FCC and Other Domestic Regulations	27
Canadian DOC and Other Regulations	27
European Applications	27

Copyright 2010. Star Trac by Unisen, Inc. All rights reserved, including those to reproduce this book or parts thereof in any form without first obtaining written permission from Star Trac.

Every effort has been made to keep this information current; however, periodically, changes are made to the information herein, and these changes will be incorporated into new editions of this publication. All product names and logos are trademarks of their respective owners.

E-ST 5090

E Series Stepper

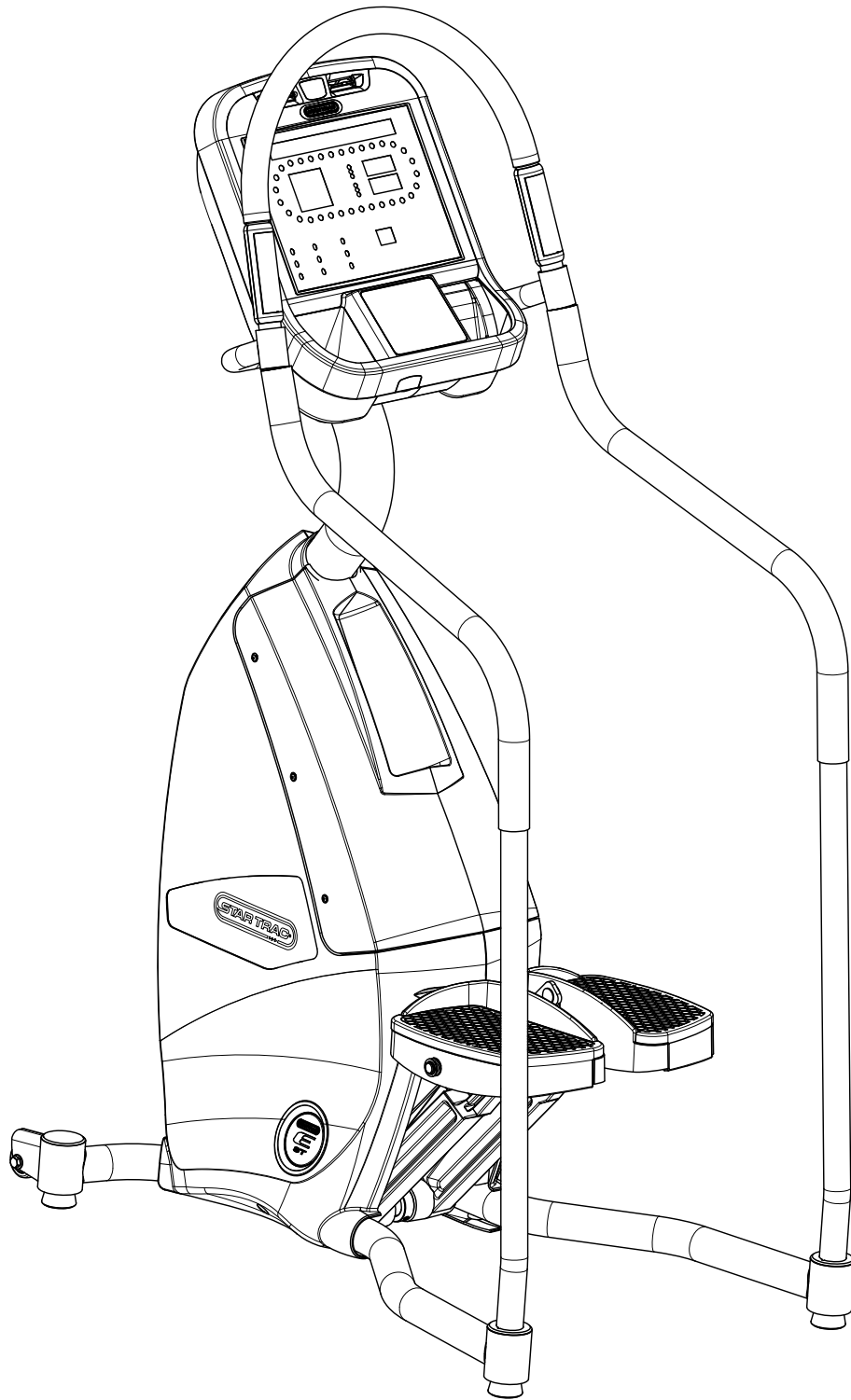

INTRODUCTION

Thank you for choosing the **STAR TRAC E-ST STEPPER**. The Stepper has been designed to provide the user the most rewarding experience based upon the carefully planned features it possesses. The design elements of this product will provide you with a comfortable, intuitive, safe and reliable experience, guiding you to a habit-forming lifestyle. Our mission is to provide products to mold lifelong habits for health and fitness, and our Stepper will provide the path to meet your goals. Step to it!

ABOUT THIS MANUAL

This manual is applicable to the **STAR TRAC E-ST STEPPER**. The manual is divided into six sections, as follows:

Introduction

Provides an overview of each section within the manual.

Safety Instructions

Provides guidelines, in multiple languages, for safely operating the Star Trac E-ST Stepper.

Assembly and Setup

Provides instructions for unpacking, assembling and setting up the Star Trac E-ST Stepper.

Operating Instructions

Provides an overview of the operation of the Star Trac E-ST Stepper.

Preventive Maintenance

Describes the preventive maintenance measures required to keep the Star Trac E-ST Stepper in top condition.

Regulatory Information

Provides regulatory information for the Star Trac E-ST Stepper.

SAFETY INSTRUCTIONS

This chapter includes fitness safeguards and precautions for the installation and use of the **STAR TRAC E-ST STEPPER**. Please read this chapter carefully before installing or using your equipment.

Safety instructions are provided in the following languages (in the order shown):

- English
- Dutch
- French
- German
- Italian
- Portuguese
- Spanish
- Swedish
- Chinese
- Japanese

PRECAUTIONS

These safety notes are directed to you as the owner of the **STAR TRAC E-ST STEPPER**. Please train all your users and fitness staff to follow these safety instructions.

Do

- Do encourage each of your users to discuss their health program or fitness regimen with a healthcare professional.
- Do stop operating your Stepper if you feel dizzy or faint.
- Do perform regular preventative maintenance.
- Do exercise slowly until you reach a level of comfort.
- Do use the Stepper only for its intended use, as described in this manual.

Do Not

- Do not let unsupervised children operate your Stepper.
- Do not use without athletic shoes.
- Do not use in rainy weather outdoors, or in an enclosed pool environment.
- Do not drop or insert any object, hands, or feet into any opening, or underneath your Stepper.
- Do not attempt to remove any shrouds or modify your Stepper.

WARNING

Your **STAR TRAC E-ST STEPPER** is designed for aerobic exercise in a commercial or consumer environment. Please check with your physician prior to beginning any exercise program.

Do not push yourself to excess. Stop if you are feeling faint, dizzy, or exhausted. Use common sense when stepping.

Read the Owner's Manual in its entirety before operating your Stepper.

Failure to obey this warning can result in injury or death.

VOORZORGSMAATREGELEN

Deze veiligheidsaantekeningen zijn aan u gericht als eigenaar van de STAR TRAC E-ST STEPPER. Gelieve uw gebruikers en uw personeel voor conditietraining volledig bekend te maken met deze veiligheidsinstructies.

Doe het volgende:

- Moedig elk van uw gebruikers aan hun gezondheidsprogramma of conditietherapie met een professioneel uit de gezondheidszorg te bespreken.
- Stop het gebruik van uw stepper als u zich duizelig of een flauwte voelt.
- Voer regelmatig preventief onderhoud uit.
- Oefen langzaam totdat u een comfortniveau heeft bereikt.
- Gebruik de stepper alleen voor zijn bedoelde gebruik, zoals in deze handleiding staat beschreven.

Doe het volgende NIET:

- Laat kinderen zonder toezicht de stepper niet bedienen.
- Niet zonder gymschoenen gebruiken.
- Niet buiten bij regenachtig weer gebruiken, of in dichte ruimte met een zwembad.
- Laat geen enkel voorwerp in de stepper vallen en steek uw handen of voeten in geen enkele opening van of onder uw stepper.
- Probeer geen omhulsels te verwijderen of uw stepper te wijzigen.

WAARSCHUWING

Uw STAR TRAC E-ST STEPPER is ontworpen voor aërobische oefeningen in een commerciële of gebruikersomgeving.

Zie uw arts vóór het beginnen van een oefenprogramma.

Dwing uzelf niet tot buitensporige oefeningen. Stop als u zich duizelig, uitgeput of een flauwte voelt.

Lees de gebruikershandleiding helemaal en aandachtig door alvorens uw stepper te bedienen.

Nalaten deze waarschuwing op te volgen kan letsel of overlijden tot gevolg hebben.

PRÉCAUTIONS

Ces consignes de sécurité s'adressent aux propriétaires du E-ST STEPPER de STAR TRAC. Veuillez instruire tous vos utilisateurs et instructeurs à suivre ces consignes.

À Faire

- Encouragez tous les utilisateurs à consulter un médecin au sujet de leur programme de fitness ou régime d'exercice.
- Cessez d'utiliser le stepper en cas d'étourdissement ou de faiblesse.
- Exécutez régulièrement la maintenance préventive.
- Commencez l'exercice lentement jusqu'à ce que vous atteignez un niveau confortable.
- Utilisez le stepper uniquement de la manière prévue, telle que décrite dans ce manuel.

À éviter

- Ne laissez pas des enfants utiliser le stepper sans surveillance.
- Ne l'utilisez pas sans porter de chaussures d'athlétisme.
- Ne l'utilisez pas en extérieur lors de temps pluvieux, ni en intérieur dans une salle de piscine.
- Évitez de laisser tomber tout objet ou d'introduire les mains ou pieds dans toute ouverture ou en-dessous du stepper.
- Ne tentez pas de retirer tout carter de protection ni de modifier le stepper.

AVERTISSEMENT

Le E-ST STEPPER de STAR TRAC est conçu pour l'exercice aérobique dans un environnement commercial ou privé.

Veuillez consulter un médecin avant de commencer tout programme d'exercice.

Ne vous poussez pas au-delà de vos limites. Arrêtez-vous si vous vous sentez faible, étourdi ou épuisé. Faites preuve de bon sens lorsque vous vous entraînez.

Lisez le guide de l'utilisateur en entier avant d'utiliser le stepper.

Le non-respect de ces avertissements peut se traduire par des blessures, voire la mort.

VORSICHTSMASSNAHMEN

Die folgenden Vorsichtsmaßnahmen richten sich an Sie als Besitzer des STAR TRAC E-ST STEPPER. Bitte schulen Sie alle Ihre Benutzer und Ihr Fitness-Personal in der Beachtung dieser Sicherheitsvorschriften.

Gebote

- Legen Sie jedem Ihrer Benutzer nahe, sein Gesundheits- oder Fitnessprogramm mit einem medizinischen Fachmann zu besprechen.
- Beenden Sie den Betrieb Ihres stepper, wenn Sie sich schwindelig oder schwach fühlen.
- Führen Sie regelmäßige vorbeugende Wartungsmaßnahmen durch.
- Trainieren Sie langsam, bis Sie eine gewisse Komfortzone erreichen.
- Verwenden Sie den stepper nur zum vorgesehenen, in dieser Anleitung beschriebenen Zweck.

Verbote

- Lassen Sie den stepper nicht von unbeaufsichtigten Kindern in Betrieb nehmen.
- Benutzen Sie das Gerät nicht ohne Sportschuhe.
- Benutzen Sie das Gerät bei regnerischen Witterungsbedingungen nicht im Freien und nicht in einer geschlossenen Schwimmbadumgebung.
- Lassen Sie keine Gegenstände in irgendwelche Öffnungen oder unter den stepper fallen und halten Sie Hände und Füße von diesen Bereichen fern.
- Unternehmen Sie keinen Versuch, irgendwelche Abdeckungen zu entfernen oder den stepper zu modifizieren.

ACHTUNG

Der STAR TRAC E-ST STEPPER ist für aerobische Übungen in einer kommerziellen oder Verbrauchenumgebung vorgesehen.

Bitte holen Sie vor Aufnahme eines jeden Trainingsprogramms den Rat Ihres Arztes ein.

Trainieren Sie nicht übertrieben hart. Hören Sie auf, wenn Sie ein Schwäche-, Schwindel- oder Erschöpfungsgefühl verspüren. Lassen Sie sich beim Schrittraining von Ihrer Vernunft leiten.

Lesen Sie vor Inbetriebnahme Ihres stepper die Bedienungsanleitung vollständig durch.

Ein Missachten dieses Achtungshinweises kann Verletzungen oder den Tod zur Folge haben.

PRECAUZIONI

Queste note precauzionali sono dirette a voi, come proprietario dello STAR TRAC E-ST STEPPER. Siete pregati di istruire i vostri utenti e il vostro personale all'osservanza di queste precauzioni.

Da Fare

- Incoraggiate i vostri utenti a discutere il loro programma di salute o di fitness con uno specialista dell'healthcare.
- Interrompete l'uso dello stepper se avete giramenti di testa o se vi sentite mancare.
- Eseguite periodicamente servizi di manutenzione.
- Utilizzate lo stepper soltanto per l'uso a cui è destinato, come descritto nel manuale.

Da Non Fare

- Non consentite a bambini di usare lo stepper senza la supervisione di un adulto.
- Non utilizzate lo stepper senza scarpe atletiche.
- Non utilizzate lo stepper all'esterno in condizioni piovose o in un ambiente con piscina interna.
- Non lasciate cadere oggetti sullo stepper e non inserite oggetti, mani o piedi in qualsiasi apertura esterna o sotto lo Stepper.
- Non cercate di rimuovere le coperture o di modificare lo stepper.

AVVERTENZE

Lo STAR TRAC E-ST STEPPER è stato realizzato per esercizi di aerobica in un ambiente pubblico o privato adeguato.

Prima di iniziare un programma di esercizio fisico, consultate il vostro medico.

Non eccedete i vostri limiti. Fermatevi se vi sentite mancare, se avete giramenti di testa o se vi sentite esausti. Usate buon senso nell'utilizzo dell'attrezzatura.

Leggete il Manuale dell'utente interamente prima di utilizzare lo stepper.

La mancata osservanza di queste avvertenze può comportare lesioni gravi o morte.

PRECAUÇÕES

Estas notas de segurança destinam-se a você, proprietário do STAR TRAC E-ST STEPPER. Treine todos os usuários e o pessoal da academia para que sigam estas instruções de segurança.

O que fazer

- Incentive todos os usuários a discutirem seu programa de saúde ou sistema de condicionamento físico com um profissional da área de saúde.
- Pare o funcionamento do stepper se sentir tontura ou vertigem.
- Efetue a manutenção preventiva regular.
- Faça exercícios lentamente até atingir um grau de conforto.
- Use o stepper apenas de acordo com a finalidade para que se destina, conforme descrito neste manual.

O que não fazer

- Não deixe crianças sem supervisão operarem o stepper.
- Não use sem os sapatos esportivos apropriados.
- Não utilize em ambientes externos quando o tempo estiver chuvoso, nem em um ambiente fechado de piscina interna.
- Não deixe cair nem insira nenhum objeto, mãos ou pés em qualquer abertura ou sob o stepper.
- Não tente remover nenhum degrau nem modificar seu stepper.

ADVERTÊNCIA

Seu STAR TRAC E-ST STEPPER foi projetado para exercícios aeróbicos em um ambiente comercial ou próprio do consumidor.

Consulte seu médico antes de começar qualquer programa de exercícios.

Não se esforce demais. Pare se sentir tontura, vertigem ou exaustão. Tenha bom senso ao fazer o exercício.

Leia todo o Manual do Proprietário antes de operar o seu stepper.

Deixar de observar esta advertência pode resultar em ferimentos ou morte.

PRECAUCIONES

Estas notas de seguridad están dirigidas a usted como el dueño de STAR TRAC E-ST STEPPER. Por favor instruya a todos sus usuarios y personal de entrenamiento para que sigan estas instrucciones de seguridad.

Lo que se debe hacer

- Dígale a cada uno de sus usuarios que discuta su programa de salud o régimen de ejercicio con un profesional de la salud.
- Deje de operar su stepper si se siente mareado o como que va a desmayarse.
- Lleve a cabo mantenimiento preventivo a intervalos regulares.
- Haga ejercicio lentamente hasta que alcance un nivel en el que se sienta cómodo.
- Utilice el stepper solamente para lo que fue diseñado, como se describe en este manual.

Lo que no se debe hacer

- No permita que los niños operen su stepper sin supervisión.
- No lo use sin zapatos atléticos.
- No lo utilice afuera en la lluvia ni en un ambiente cerrado donde haya una piscina.
- No lo deje caer ni inserte objetos, manos o pies en ninguna apertura de su stepper ni debajo de él.
- No intente quitar ninguna cubierta o recubrimiento ni modificar su stepper.

ADVERTENCIA

Su STAR TRAC E-ST STEPPER está diseñado para el ejercicio aeróbico en un ambiente comercial o de consumo.

Por favor consulte con su médico antes de iniciar cualquier programa de ejercicio.

No haga un esfuerzo excesivo. Deténgase si se siente mareado, exhausto o como si fuera a desmayarse. Use su sentido común al hacer ejercicio.

Lea completamente el Manual del dueño antes de operar su stepper.

El no cumplir con esta advertencia puede resultar en una lesión o en la muerte.

FÖRSIKTIGHETSÅTGÄRDER

Dessa säkerhetsanmärkingar är riktade till dig i egenskap av ägare av STAR TRAC E-ST STEPPER. Var god utbilda alla användare och all personal att följa dessa säkerhetsanvisningar.

Man ska

- uppmuntra alla användare att konsultera sitt hälsoprogram eller sin träningsregim med en läkare.
- sluta använda stepper om man känner sig yr eller svimfärdig.
- utföra regelbundet underhåll i förebyggande syfte.
- motionera långsamt tills man når en komfortnivå.
- endast använda stepper för dess avsedda användning, enligt beskrivning i denna handbok.

Man ska inte

- låta barn använda stepper utan uppsikt.
- använda stepper utan sportskor.
- använda stepper utomhus i fuktigt väder eller i ett inneslutet bassängområde.
- tappa in eller föra in något föremål, händer eller fötter i någon öppning, eller under stepper.
- försöka att avlägsna några skyddskåpor eller att modifiera stepper.

VARNINGAR

Din STAR TRAC E-ST STEPPER är avsedd för aerobisk träning i kommersiella eller konsumentinriktade miljöer.

Konsultera din läkare innan du inleder något träningsprogram.

Driv inte dig själv för hårt. Sluta om du känner dig yr, svimfärdig eller utmattad. Använd stepper med sunt förnuft.

Läs igenom hela handboken innan du använder stepper.

Underlåtelse att iakttä dessa varningar kan medföra skada eller dödsfall.

注意事项

以下安全注意事项是专门为STAR TRAC E-ST STEPPER的拥有人而制订的。请务必训练所有设备使用者和健身房工作人员遵守这些安全注意事项。

要:

- 鼓励所有使用者与专业医疗保健人员商讨他们的医疗保健方案或健身进程。
- 使用stepper时若感觉到晕眩或虚弱，请立即停止使用。
- 定期维护设备。
- 锻炼要慢慢开始直至达到一个自如的程度。
- 仅将stepper用作本使用手册所列的用途。

不要

- 不要让无人看管的儿童使用您的stepper。
- 没穿运动鞋时不要使用。
- 下雨时不要在室外使用，也不要不要在室内游泳池附近使用。
- stepper的敞开部位或底下不要掉落或塞进任何物件、包括手或脚。
- 不要尝试拆除任何覆盖物或改装您的stepper。

警告

STAR TRAC E-ST STEPPER是专门设计用于商业或消费用途的健身锻炼设备。

开始任何锻炼计划之前，请先与您的医生进行商讨。

不要过于勉强自己。如果感觉到虚弱、晕眩或疲倦就应停止运动。运用常识正确举步。

使用stepper前请先完整阅读使用手册。

如不遵从以上警告有可能导致受伤或死亡。

注意事項

以下の安全に対する注意事項は、STAR TRAC E-ST STEPPERのオーナーに対するものです。オーナーは、すべてのユーザーおよびフィットネススタッフ全員が以下の安全に対する注意事項に従うよう指導してください。

実施すべきこと

- ユーザーには、ヘルスケア専門家と各自のヘルスプログラムまたはフィットネス管理法について話し合うよう奨励する。
- 目まいを感じたり気が遠くなった時は、stepperの使用を中止する。
- 定期的に予防メンテナンスを実施する。
- 快適なレベルに達するまではゆっくりと運動する。
- 本マニュアルに従って、意図された目的のみのためにstepperを使用する。

すべきでないこと

- 大人の監督下でない子供にstepperを使用させる。
- 運動靴の着用なしに使用する。
- 雨天時の屋外における使用、閉ざされた屋内プール環境での使用。
- stepperを落下させる、あるいは使用中のstepperまたはstepperの下に異物、手、足を入れる。
- 保護カバーをはずそうと試みる、またはstepperを改造する。

警告

STAR TRAC E-ST

STEPPERは、商業環境および消費者環境でエアロビクス（有酸素）運動を行うために設計されています。

エクササイズプログラムを始める前に、必ず医師に健康状態を確認してください。

無理な運動は避けてください。気が遠くなったり、目まいを感じたり、ひどく疲れた場合は、すぐに運動を中止してください。使用に際しては常識的な判断を下してください。

stepperを使い始める前に、オーナーズ・マニュアルを最後まで読んでください。

以上の警告に従わない場合には、負傷あるいは死亡などの結果を招く可能性があります。

ASSEMBLY AND SETUP

The following parts are included with the base **STAR TRAC E-ST STEPPER**:

Description	Qty	Description	Qty
Base	1	Screw, 1/4-20 x 1.25, Hex Head	4
Display Weldment with Neck Assembly	1	Washer, 1/4 ID Type B, Flat	4
Handrails (1 Right, 1 Left)	2	Screw, 1/4-28 x 1/2, Button Head	4
Screw, .312-18 x 1.00, Hex Head	4		
Washer, .312 Split Lock	4		
Washer, .312 Flat	4		
Nut, .312-18, Hex Machine	4		

NOTE: The Display Assembly is found in its own box, along with the unit's detailed operating instructions.

UNPACKING AND ASSEMBLY

NOTE: Inspect the shipping carton for any parts that may be missing BEFORE discarding the carton. Items can shift during transportation, and may be accidentally discarded with the carton. If any parts are missing, please contact Star Trac Support at 800-503-1221. Have the serial number of the **STAR TRAC E-ST STEPPER**, and the part number(s) of the missing parts ready so they may be shipped to you.

1. Unpack the Shipping Carton

Open the top of the **STAR TRAC E-ST STEPPER** box, remove the handrails and place aside. Remove the Display weldment/Next assembly and place aside. Remove the fasteners and place aside. Remove remaining packing material, and carefully remove from the pallet base.

Note: The display comes in a separate box.

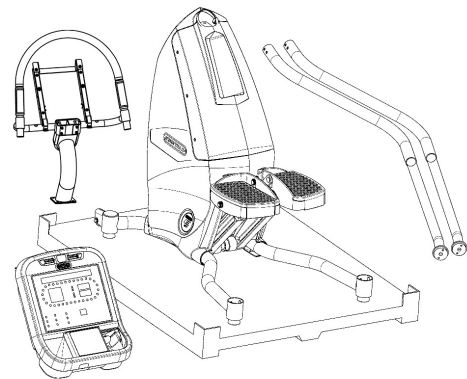

2. Removing the Shrouds

Remove the 6 screws that hold on the center shroud in place. Next remove the 6 screws that hold the side shrouds in place. Remove the side shrouds from frame. Set the 3 shrouds and 12 screws aside for later use.

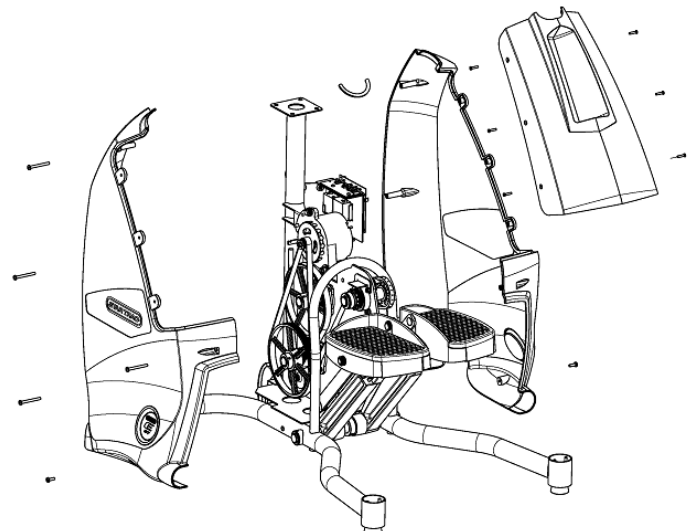

3. Installing the Display Weldment/Neck Assembly

(a) Align the Display Weldment with the base. Using the pre-installed wire pull the Main I/O cable (large white plastic connector), power harness (small white plastic connector), and coaxial cable (black rubber cover) from the bottom through the top of the neck for mating to the display as needed. It is recommended that each wire be pulled through the neck one at a time. Take care to avoid unnecessary tension or bending of the cables. If the base will be mated with an LED display without a PVS kit it is recommended to tuck the power harness and coaxial cable inside the neck as they won't be used.

(b) Install the 4 bolts with the associated flat washers, lock washers, and nuts as shown. Make sure the bolts are tight. After the Neck Assembly has been bolted in place, you can replace the shrouds that were removed as part of Step 2 above.

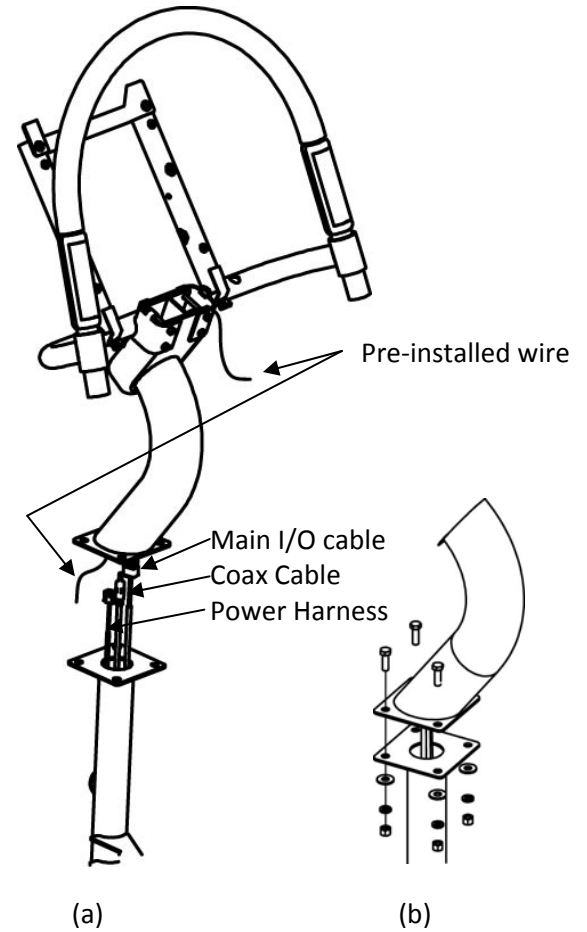

4. Open Display

Remove (2) M4 x 0.7 screws from back of display (retain for later use) with a #2 Phillips screwdriver and separate the back of the display from the front.

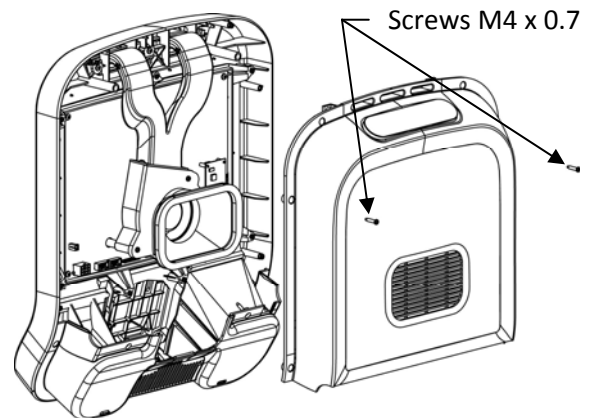

5. Installing the Display Assembly

(a) Take the rear display cover and attach it to the display weldment using the supplied screws. Note that the Neck Assembly has been hidden to show the important detail but will already be attached.

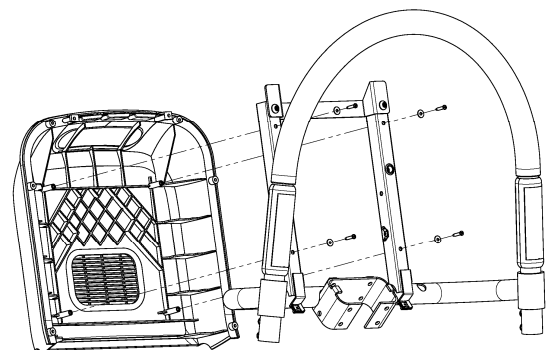

(b) It is now time to attach the display. *NOTE: This step assumes that you will be attaching the LED display. Should you be installing the embedded display or adding a PVS kit, please refer to those applicable manuals.* The following display connections will need to be made: connect the main display cable to the connector labeled J4 on the display PCB, connect the heart rate grip cable to the heart rate board, and connect the ground wire from the heart rate board to the quick disconnect tab on the display weldment.

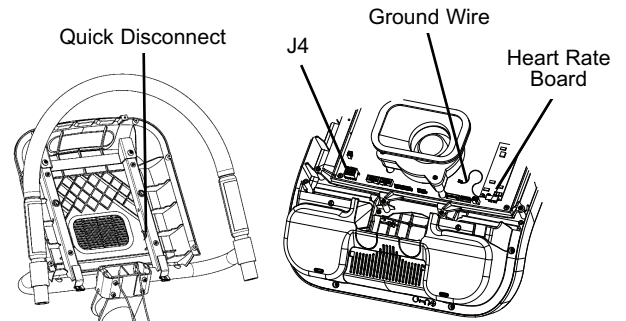

(c) With the display electrical connections made, you can now attach the display. There are 2 tabs located on the bottom of the display weldment, so in order to attach the display, you will first need to guide the bottom of the display under the tabs and then second you will need pivot the display forward around the tabs to mate the display to the rear plastics. Once in place, you can attach the screws.

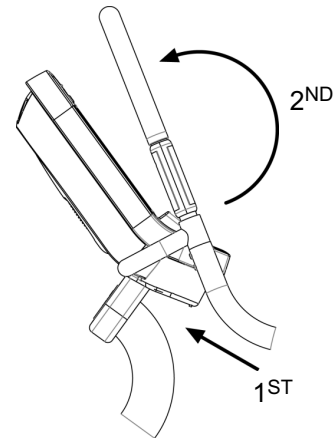

(d) With the display in place, attach the 8 M4 x 0.7 screws provided. 6 screws go around the rear of the display and 2 go near the underside of the cupholders as shown.

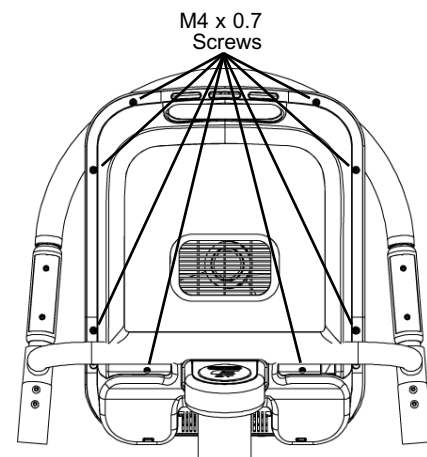

5. Installing the Handrails

NOTE: It is recommended that this step be performed by at least 2 people.

- With the assistance of another person, tip the **STAR TRAC E-ST STEPPER** forward and hold in place while completing the following steps.
- Remove the 2 rear leg levelers.
- Slide the left handrail into the upper end of the left handlebar weldment and line up the screw holes.
- Loosely attach 2 supplied button head screws to the left handlebar weldment junction using a 5/32" (4mm) hex key or T-handle.

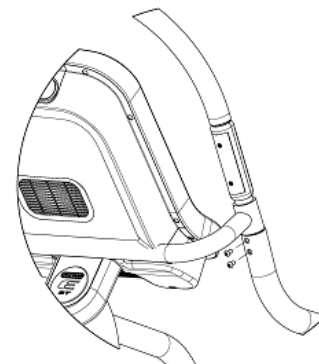

- (e) Position the lower end of the left handrail over the rear leg weldment, then pulling the handrail towards you secure it into position with 2 washers and 2 hex screws provided using a 5/32" (4mm) hex key or T-handle.
- (f) Tighten the button head screws from step d above.
- (g) Repeat steps c - f for the right handrail.
- (h) Replace the 2 leg levelers that were removed in step b.
- (i) Return the **STAR TRAC E-ST STEPPER** to the upright position.

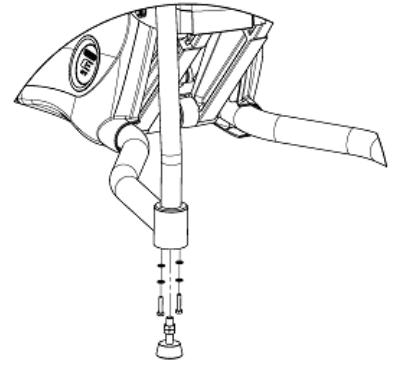

6. Final Assembly and Testing

Check all screws to ensure they are tightened securely.

Adjust leveling feet to assure that the Stepper is level to the floor and does not rock back and forth.

Make sure the side handrails are tight.

Mount the Stepper, begin stepping, and verify that the display panel turns on.

Operate the unit to check for proper operation.

You have now completed assembly of your **STAR TRAC E-ST STEPPER**.

OPERATING INSTRUCTIONS

Operating the **STAR TRAC E-ST STEPPER** is very easy. Simply mount the Stepper by stepping on the **Soft Trac®** pedals, begin stepping, and press **QUICK START**. Learning the features and incorporating the **STAR TRAC E-ST STEPPER** into your members' fitness programs is just as easy. In this chapter, you will learn the display functions and how to get the most out of every **STAR TRAC E-ST STEPPER** workout.

IMPORTANT: Before operating the Stepper, you must be familiar with the following equipment limitations:

- Maximum Weight: Your **STAR TRAC E-ST STEPPER** is designed for a maximum user weight of 350 lbs/158 kg. DO NOT exceed the maximum user weight.

DISPLAY PANEL FEATURES

Your **STAR TRAC E-ST STEPPER** is equipped to provide you and your users unlimited exercise opportunities. Experiment with its features to find the right combination for your fitness regimen. The Display Panel provides the operating controls and display elements described in the following paragraphs.



QUICK START Key: Enables the Stepper for manual operation using a default weight as set in Manager/Maintenance Mode, a default LEVEL of "1", and a default time limit as set in Manager/Maintenance Mode.

NOTE: Default time and weight are adjustable through Manager/Maintenance Mode.



Numeric Keypad: Allows you to enter specific values for program parameters during program setup. During a program, these keys may be used to change difficulty level.



OK Key: (part of numeric keypad) Allows you to confirm selections during program setup and operation.



ARROW Key: (part of numeric keypad) Allows you to make corrections to values entered during program setup.



Increase LEVEL Key: Increases the difficulty level, in one-level increments; levels are from **1** (least difficult) to **20** (most difficult). Current level setting is shown in the LEVEL display window.



Decrease LEVEL Key: Decreases the difficulty level from **20** (greatest difficulty) to **1** (least difficulty), in one-level increments. Current level setting is shown in the LEVEL display window.

NOTE: During program setup and while in Manager/Maintenance Mode, the **Increase LEVEL** and **Decrease LEVEL** keys increment or decrement the value shown in the Information Window.



Fan Key: Allows you to control the speed of the personal cooling fan, either OFF, HIGH or LOW.



SCROLL Keys: Scrolls the upper and lower data information windows between the three available data displays.

Preset Program Keys: Allow you to access a desired preset workout program.

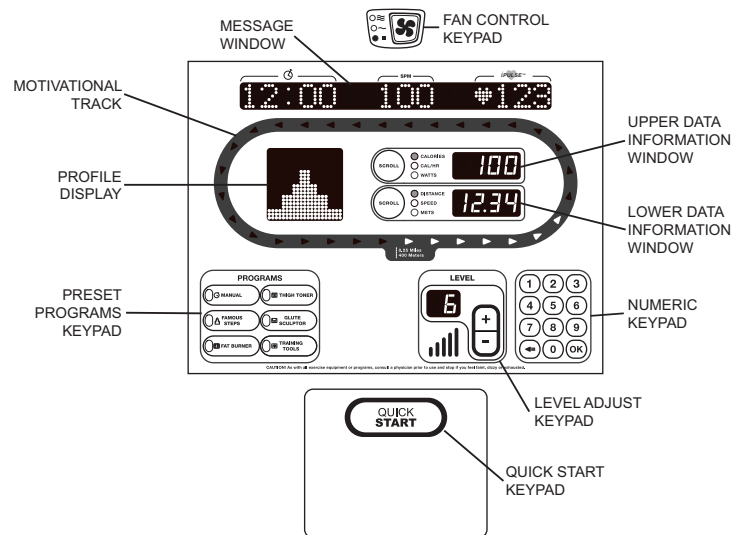

Upper Data Information Window: Shows current and aggregate data related to your workout. Pressing the associated SCROLL key scrolls between the following displays:

- CALORIES - Shows your aggregate caloric expenditure thus far in your workout.
- CAL/HR - Shows your current caloric expenditure per hour based on your current difficulty level and stepping rate.
- WATTS - Shows your current watts expenditure at that specific time during your workout.

NOTE: Press the SCROLL key to toggle between data during your workout.

Lower Data Information Window: Shows current and aggregate data related to your workout. Pressing the associated SCROLL key scrolls between the following displays:

- DISTANCE - Shows the total number of vertical feet or meters you have climbed thus far.
- SPEED - Shows the speed at which you are currently stepping, in steps-per-minute.
- METS - Shows your current METS expenditure at that specific time during your workout.

NOTE: Press the SCROLL key to toggle between data during your workout.

Graphic Display: Traces your progress through each of the programs and allows you to anticipate changes in difficulty. Display elements illuminate from left to right across the bottom of the display to indicate your progress through the course. At each step, display elements illuminate in columns to indicate your ascent up the gradient that is in effect.

Motivational Track: Shows your progress counter-clockwise around a 10-floor course, starting from the bottom center.

Information Window: Provides informational messages, prompts during program setup, feedback during your workout, notification when your workout is complete, and scrolling summarized workout data after your workout. During your workout, the Information Window shows the following data:

- TIME - Shows the duration of your workout thus far in minutes and seconds.
- FLOORS - Shows the total number of floors you have climbed thus far.
- HEART RATE - Shows your current heart rate in beats-per-minute (BPM) while wearing a heart rate strap or grasping the heart rate grips.

Depending on the program completed and Stepper settings as set in Manager/Maintenance Mode, workout data may include:

SOFT TRAC® SYSTEM

The **Soft Trac®** system is the Stepper's foot comfort and step absorption system consisting of a yielding, durable rubber pad covering both foot pedals. This system is designed to protect ankles, knees, joints, and back while reducing numbness in toes and feet and providing a comfortable stepping surface. Whether you place your feet at the front, middle, or rear of the pedals you will enjoy the benefits of the **Soft Trac®** system.

HINTS AND TIPS FOR GETTING STARTED

The following hints and tips will assist in training your users to maximize the fitness benefits of your **STAR TRAC E-ST STEPPER**.

- **Step at a rate that feels comfortable and most natural, yet is sufficient to achieve a good cardio workout.**
- **Try different stepping rhythms.** In manual operation, vary your stepping speed from slow to fast, then back to slow. As you become more comfortable with your Stepper, try stepping faster, varying the difficulty LEVEL, or using the preset programs.
- **Watch the Graphic Display to anticipate changes in difficulty.** When you use the preset programs, the display shows changes in difficulty as tall or short columns.

VIEWING WORKOUT DATA DURING A PROGRAM

Workout data is shown in three windows on the Stepper Display Panel: the Information Window (located at the top of the Display Panel) and the Upper and Lower Data Information Windows (located inside the Motivational Track, to the right of the Graphic Display).

Information shown in the Information Window during a workout includes elapsed time, number of floors climbed, and heart rate (HR), when in use. After the workout is complete, workout summary information is shown in the Information Window.

The Information Window also displays important instructions and cues throughout the workout.

The Upper and Lower Data Information Windows also display information during a workout.

To view workout data during your workout:

1. Press the Upper Data Information Window SCROLL key to view the following workout data (the current data display is indicated by an LED next to the parameter name):
 - CALORIES - Shows your aggregate caloric expenditure thus far in your workout.
 - CAL/HR - Shows your current caloric expenditure per hour based on your current difficulty level and stepping rate.
 - WATTS - Shows your current watts expenditure at that specific time during your workout.

NOTE: Press the SCROLL key to toggle between data during your workout.
2. Press the Lower Data Information Window SCROLL key to view the following workout data (the current data display is indicated by an LED next to the parameter name):
 - DISTANCE - Shows the total number of vertical feet or meters you have climbed thus far.
 - SPEED - Shows the speed at which you are currently stepping, in steps-per-minute.
 - METS - Shows your current METS expenditure at that specific time during your workout.

PAUSE MODE



If you come to a complete stop during your workout (SPM is less than 10), the Stepper will enter a “pause” mode. To continue your workout, begin stepping before the “pause” time expires and your workout data will not be lost.

COOLDOWN CYCLE

Once you have completed your workout, the Stepper enters a two-minute Cooldown cycle.

NOTE: The Stepper software is programmed to properly decrease difficulty level to provide a cooldown.

To operate the Stepper during Cooldown:

1. You can adjust the difficulty LEVEL during Cooldown.
 - Use the 0...9 keys to enter a difficulty LEVEL (from 1 to 20); or press the  or  key, as desired, to increase or decrease the difficulty LEVEL in 1 unit increments.
 - When the desired difficulty LEVEL has been entered by using the 0...9 keys, press the  key to accept the displayed LEVEL.
2. When the Cooldown cycle ends, your workout summary displays in the Information Window. If you wish to exit the Cooldown cycle before it ends automatically, stop stepping.

USING THE PERSONAL FAN

The **STAR TRAC E-ST STEPPER** is equipped with a built-in personal fan to increase your comfort during a workout. You can control the fan speed during your workout.

To operate the personal fan:

- Press the  key, as necessary, to cycle the personal fan from OFF to HIGH to LOW to OFF. An LED indicator lights to show the currently selected fan speed.
- The fan remains set at the set speed if you pause your program, unless your workout was less than two minutes in length.
- The fan turns off automatically if you exit your workout, or when you complete your workout program.
- The fan turns off automatically if you pause your program and the time elapsed is less than two minutes.

HEART RATE MONITORING

Heart rate monitoring allows you to determine if your workout is too challenging or not challenging enough. Monitoring your heart rate is easy with the **STAR TRAC E-ST STEPPER**. You may use a heart rate strap, or you can simply grasp the silver contact heart rate grips. Your goal will be to keep your exercise heart rate between 60 and 90 percent of the theoretical maximum for your age, as shown in the accompanying Target Heart Rate table.



NOTE: The Heart Rate monitor is not a medical test, nor is it designed as a medical test. It is simply a guide to target heart rate training. Please consult with your physician prior to engaging in any strenuous physical activity.

NOTE: If both the heart rate grips and a heart rate strap are being used, the heart rate grips will override and be displayed in the HR window.

IMPORTANT: The manufacturer does not warrant the heart rate system **performance** on this product, as the heart rate system performance varies, based on a user's physiology, fitness level, age, method of use and other factors. Furthermore, the heart rate system is not for medical use.

CONTACT HEART RATE MONITORING

You may use the heart rate contact grips to automatically check your heart rate while stepping. Just follow these steps.

1. Grasp the stainless steel heart rate contact grips; you do not have to squeeze tightly.
 - When the heart rate contact grips are grasped, the  will display and an audible “beep” will sound to indicate that a heart rate has been detected.
2. It may take from 30 to 60 seconds for the heart rate system to acquire and display your heart rate.
3. When your heart rate has been acquired, the  indicator and your heart rate in beats per minute (BPM) display in the HEART RATE field of the Information Window.
4. Release the Heart Rate grips if you wish to remove your heart rate reading from the display.

CHEST STRAP HEART RATE MONITORING

You may use the heart rate strap to automatically check your heart rate. Just follow these steps:

1. Before beginning your workout, or during a pause, moisten the back of the transmitter on the heart rate strap. Place the strap snugly around your chest with the transmitter resting directly over your sternum.
2. When your heart rate has been acquired, the  indicator and your heart rate in beats per minute (BPM) display in the HEART RATE field of the Information Window.
3. Remove the heart rate strap if you wish to remove your heart rate reading from the display.





NOTE: The performance of the transmitter may be affected by body types, body oils, metal in clothing, and outside electrical interference. Always be sure that the transmitter and skin are in good contact. Avoid operating other electrical equipment near your Stepper when you use the heart rate strap.

QUICK START



Quick Start lets you begin your workout by simply pressing one key, or by stepping for approximately 13 seconds without pressing any key. Quick Start uses a default weight as set in Manager/Maintenance Mode, a difficulty LEVEL of 1, and a time limit as set in Manager/Maintenance Mode. YOU control resistance LEVEL during the entire program.

To operate the Quick Start program:

1. Mount the Stepper, begin stepping, and press the QUICK START key.
2. If desired, you can use the personal fan during your workout (see “Using the Personal Fan” for details).
3. You can adjust the difficulty LEVEL during the program, using either of the following methods.
 - Use the ... keys to enter a difficulty LEVEL (from 1 to 20). When the desired level has been entered, press the  key to confirm the difficulty LEVEL.
 - Press the  or  key, as desired, to increase or decrease the difficulty LEVEL in 1 unit increments.
4. You can scroll through workout data during the program (see “Viewing Workout Data During a Program” for details).

5. If you wish to pause the program, stop stepping. The Stepper will enter pause mode and display your workout results for one entire cycle.
6. When you have reached your workout goal, the Stepper enters the Cooldown cycle (see “Cooldown Cycle” for details). If you wish to exit the program before you have reached your workout goal, stop stepping and allow the Pause timer to expire. If you wish to skip the Cooldown cycle, press the  key to view your workout summary.

PRESET PROGRAMS

The **STAR TRAC E-ST STEPPER** offers 8 preset programs to add variety and challenge to your workout. Additionally, the HR TRAINING feature lets you select one of two cardio-intensive training programs, or a Fitness Test.

Pre-set programs include:

Allows the user to pre-program a time goal and user weight. Difficulty is determined by the user during the program.

Provides a high intensity interval workout.

Provides a workout designed to target the thigh muscles.

Provides a workout designed to target the gluteal muscles.

Provides a motivational workout in which the user can climb one of nine famous landmarks.





















Advanced programs that offer the user the ability to train in specific HR zones, or perform a Fitness Test.

NOTE: When entering setup data for any program, if the  key is not pressed, the system will “auto-advance” through the prompts.

MANUAL PROGRAM

The MANUAL program allows the user to pre-program a time goal, difficulty LEVEL and user weight. Difficulty LEVEL can be adjusted by the user during the program.

To operate the MANUAL program:

























1. Mount the Stepper, begin stepping, and press the  key.
2. You are prompted to enter your weight. The Stepper displays a default weight as set in Manager/Maintenance Mode. You may enter any weight from 1 to 350 pounds (1 to 158 kg).
 - Use the ... keys to enter your current weight; or press the  or  key, as necessary, to increase or decrease the displayed weight in 1 pound (or 1 kg) increments.
 - When your correct weight has been entered, press the  key to accept the displayed value.
3. You are prompted to enter a time goal. The default time is 20 minutes, or equal to the time parameter set in Manager/Maintenance Mode if less than 20 minutes. You may enter any time from 1 to 99 minutes.
 - Use the ... keys to enter your desired time goal; or press the  or  key, as necessary, to increase or decrease the displayed value in 1 minute increments.
 - When your desired goal has been entered, press the  key to accept the displayed value.
4. You are prompted to enter a difficulty LEVEL.
 - Use the ... keys to enter a difficulty LEVEL (from 1 to 20) or press the  or  key, as desired, to increase or decrease the difficulty LEVEL in 1 unit increments.
 - When the desired difficulty LEVEL has been entered, press the  key to accept the displayed LEVEL.
5. If desired, you can use the personal fan during your workout (see “Using the Personal Fan” for details).
6. You can adjust the difficulty LEVEL during the program, using either of the following methods:
 - Use the ... keys to enter a difficulty LEVEL (from 1 to 20). When the desired level has been entered, press the  key to confirm the difficulty LEVEL.
 - Press the  or  key, as desired, to increase or decrease the difficulty LEVEL in 1 unit increments.

7. You can scroll through workout data during the program (see “Viewing Workout Data During a Program” for details).
8. If you wish to pause the program, stop stepping. The Stepper will enter pause mode and display your workout results for one entire cycle.
9. When you have reached your workout goal, the Stepper enters the Cooldown cycle (see “Cooldown Cycle” for details). If you wish to exit the program before you have reached your workout goal, stop stepping and allow the Pause timer to expire.

FAT BURNER PROGRAM

The FAT BURNER program provides a high intensity interval workout.



















To operate the program:

1. Mount the Stepper, begin stepping, and press the  key.
2. You are prompted to enter your weight. The Stepper displays a default weight as set in Manager/Maintenance Mode. You may enter any weight from 1 to 350 pounds (1 to 158 kg).
 - Use the    keys to enter your current weight; or press the  or  key, as necessary, to increase or decrease the displayed weight in 1 pound (or 1 kg) increments.
 - When your correct weight has been entered, press the  key to accept the displayed value.
3. You are prompted to enter a time goal. The Stepper displays a default time of 20 minutes, or equal to the time parameter set in Manager/Maintenance Mode if less than 20 minutes. You may enter any time from 1 to 99 minutes.
 - Use the    keys to enter the desired time goal, or press the  or  key, as necessary, to increase or decrease the displayed value in 1 minute increments.
 - When your desired time goal has been entered, press the  key to accept the displayed value.
4. You are prompted to enter a difficulty LEVEL.
 - Use the    keys to enter a difficulty LEVEL (from 1 to 20) or press the  or  key, as desired, to increase or decrease the difficulty LEVEL in 1 unit increments.
 - When the desired difficulty LEVEL has been entered, press the  key to accept the displayed LEVEL.
5. If desired, you can use the personal cooling fan during your workout (see “Using the Cooling Fan” for details).
6. You can adjust the difficulty LEVEL during the program using either of the following methods:
 - Use the    keys to enter a difficulty LEVEL (from 1 to 20). When the desired difficulty LEVEL has been entered, press the  key to confirm the difficulty LEVEL.
 - Press the  or  key, as desired, to increase or decrease the difficulty LEVEL in 1 unit increments.
7. You can scroll through workout data during the program (see "Viewing Workout Data During a Program" for details).
8. If you wish to pause the program, stop stepping. The Stepper will enter pause mode and display your workout results for one entire cycle.
9. When you have reached your workout goal, the Stepper enters the Cooldown cycle (see “Cooldown Cycle” for details). If you wish to exit the program before you have reached your workout goal, stop stepping and allow the Pause timer to expire.

GLUTE SCULPTOR PROGRAM

The GLUTE SCULPTOR program provides a workout designed to target your gluteal muscles. For best results while using the GLUTE SCULPTOR program, stand up straight while stepping, and take long steps.









To operate the GLUTE SCULPTOR program:

1. Mount the Stepper, begin stepping, and press the  key.
2. You are prompted to enter your weight. The Stepper displays a default weight as set in Manager/Maintenance Mode. You may enter any weight from 1 to 350 pounds (1 to 158 kg).
 - Use the  keys to enter your current weight; or press the  or  key, as necessary, to increase or decrease the displayed weight in 1 pound (or 1 kg) increments.
 - When your correct weight has been entered, press the  key to accept the displayed value.
3. You are prompted to enter a time goal. The Stepper displays a default time of 20 minutes, or equal to the time parameter set in Manager/Maintenance Mode if less than 20 minutes. you may enter any time from 1 to 99 minutes.
 - Use the  keys to enter the desired time goal, or press the  or  key, as necessary, to increase or decrease the displayed value in 1 minute increments.
 - When your desired time goal has been entered, press the  key to accept the displayed value.
4. You are prompted to enter a difficulty LEVEL.
 - Use the  keys to enter a difficulty LEVEL (from 1 to 20) or press the  or  key, as necessary, to increase or decrease the difficulty LEVEL in 1 unit increments.
 - When the desired difficulty LEVEL has been entered, press the  key to confirm the difficulty LEVEL.
5. If desired, you can use the personal fan during your workout (see "Using the Personal Fan" for details).
6. You can adjust the difficulty LEVEL during the program, using either of the following methods:
 - Use the  keys to enter a difficulty LEVEL (from 1 to 20). When the desired level has been entered, press the  key to confirm the difficulty LEVEL.
 - Press the  or  key, as necessary, to increase or decrease the difficulty LEVEL in 1 unit increments.
7. You can scroll through workout data during the program (see "Viewing Workout Data During a Program" for details).
8. If you wish to pause the program, stop stepping. The Stepper will enter a pause mode and display your workout results for one entire cycle.
9. When you have reached your workout goal, the Stepper enters the Cooldown cycle (see "Cooldown Cycle" for details). If you wish to exit the program before you have reached your workout goal, stop stepping and allow the Pause timer to expire. If you wish to skip the Cooldown cycle, press the  key to view your workout summary.

THIGH TONER PROGRAM

The THIGH TONER program provides a workout designed to target your thigh muscles. For best results while using the THIGH TONER program, lean forward slightly while stepping, and take short steps.

To operate the THIGH TONER program:

1. Mount the Stepper, begin stepping, and press the  key.
2. You are prompted to enter your weight. The Stepper displays a default weight as set in Manager/Maintenance Mode. You may enter any weight from 1 to 350 pounds (1 to 158 kg).
 - Use the  keys to enter your current weight; or the  or  key, as necessary, to increase or decrease the displayed weight in 1 pound (or 1 kg) increments.
 - When your correct weight has been entered, press the  key to accept the displayed value.
3. You are prompted to enter a time goal. The Stepper displays a default time of 20 minutes, or equal to the time parameter set in Manager/Maintenance Mode if less than 20 minutes. you may enter any time from 1 to 99 minutes.
 - Use the  keys to enter the desired time goal, or press the  or  key, as necessary, to increase or decrease the displayed value in 1 minute increments.

- When your desired time goal has been entered, press the **OK** key to accept the displayed value.
4. You are prompted to enter a difficulty LEVEL.
 - Use the **0...9** keys to enter a difficulty LEVEL (from 1 to 20) or press the **▲** or **▼** key, as necessary, to increase or decrease the difficulty LEVEL in 1 unit increments.
 - When the desired difficulty LEVEL has been entered, press the **OK** key to confirm the difficulty LEVEL.
 5. If desired, you can use the personal fan during your workout (see "Using the Personal Fan" for details).
 6. You can adjust the difficulty LEVEL during the program, using either of the following methods:
 - Use the **0...9** keys to enter a difficulty LEVEL (from 1 to 20). When the desired level has been entered, press the **OK** key to confirm the difficulty LEVEL.
 - Press the **▲** or **▼** key, as necessary, to increase or decrease the difficulty LEVEL in 1 unit increments.
 7. You can scroll through workout data during the program (see "Viewing Workout Data During a Program" for details).
 8. If you wish to pause the program, stop stepping. The Stepper will enter a pause mode and display your workout results for one entire cycle.
 9. When you have reached your workout goal, the Stepper enters the Cooldown cycle (see "Cooldown Cycle" for details). If you wish to exit the program before you have reached your workout goal, stop stepping and allow the Pause timer to expire. If you wish to skip the Cooldown cycle, press the **OK** key to view your workout summary.

FAMOUS STEPS PROGRAM

The FAMOUS STEPS program provides a motivational workout in which you can climb one of nine famous landmarks.

To operate the FAMOUS STEPS program:

1. Mount the Stepper, begin stepping, and press the **FAMOUS STEPS** key.
2. You are prompted to choose a famous landmark to climb. The Information Window shows the number and name of the current landmark. The Graphic Display shows the number of steps required to climb the landmark. The list of landmarks is cycled in the Information window until a landmark is chosen. Use the **0...9** keys to select the landmark you wish to climb, or press the **OK** key to select the currently displayed landmark. Details for each landmark are as follows:

Number	Name	Steps
1	Leaning Tower of Pisa	293
2	Taj Mahal	360
3	Great Pyramid	720
4	Space Needle	915
5	Petronas Towers	1,318
6	Empire State Building	1,576
7	CN Tower	1,776
8	Sears Tower	2,232
9	Eiffel Tower	2,731

NOTE: The number of steps for each landmark is based on the actual number of stairs for the landmark (if the information is available). If the number of steps is not available, or if the landmark does not have stairs leading to the top, the number of steps is based on the overall height of the landmark. The number of steps is calculated based on fifteen 8-inch stairs for each 10 vertical feet of height.

3. You are prompted to enter your weight. The Stepper displays a default weight as set in Manager/Maintenance Mode. You may enter any weight from 1 to 350 pounds (1 to 158 kg).
 - Use the **0...9** keys to enter your current weight; or press the **▲** or **▼** key, as necessary, to increase or decrease the displayed weight in 1 pound (or 1 kg) increments.
 - When your correct weight has been entered, press the **OK** key to accept the displayed value.
4. You are prompted to enter a difficulty LEVEL.

- Use the **0...9** keys to enter a difficulty LEVEL (from 1 to 20) or press the **▲** or **▼** key, as necessary, to increase or decrease the difficulty LEVEL in 1 unit increments.
 - When the desired difficulty LEVEL has been entered, press the **OK** key to confirm the difficulty LEVEL.
5. If desired, you can use the personal fan during your workout (see "Using the Personal Fan" for details).
 6. You can adjust the difficulty LEVEL during the program, using either of the following methods:
 - Use the **0...9** keys to enter a difficulty LEVEL (from 1 to 20). When the desired level has been entered, press the **OK** key to confirm the difficulty LEVEL.
 - Press the **▲** or **▼** key, as necessary, to increase or decrease the difficulty LEVEL in 1 unit increments.
 7. You can scroll through workout data during the program (see "Viewing Workout Data During a Program" for details).
 8. If you wish to pause the program, stop stepping. The Stepper will enter a pause mode and display your workout results for one entire cycle.
 9. When you have reached your workout goal, the Stepper enters the Cooldown cycle (see "Cooldown Cycle" for details). If you wish to exit the program before you have reached your workout goal, stop stepping and allow the Pause timer to expire. If you wish to skip the Cooldown cycle, press the **OK** key to view your workout summary.

HEART RATE CONTROL PROGRAMS

TRAINING TOOLS offers both an Interval Heart Rate Control program and a Constant Heart Rate Control program, as well as a Fitness Test.

NOTE: For best results, use a heart rate strap. If user is wearing a heart rate strap, the Stepper will automatically use the data from the heart rate strap. Contact heart rate grips may not give an accurate heart rate.

To operate the INTERVAL HEART RATE Control program:

This heart rate feature is designed to gradually elevate your heart rate to the upper end of your selected training range, then gradually decrease your heart rate to the lower end of your selected training range by dynamically controlling the difficulty level. During the workout, this cycle will repeat several times until the time goal is complete, creating an interval training effect that is customized to the user's desired heart rate training range.

During program setup, there must be at least an 20 BPM difference between the lower heart rate limit and upper heart rate limit to ensure an interval workout.

By including interval exercise in your regular aerobic program, greater effects are noticed. Your heart and muscles will adapt to the increases in demand by utilizing stored calories for energy more effectively. Interval Heart Rate Control may potentially result in more calories expended. It will strengthen the heart, provide stress relief and variety to a workout. This program is more effective in training the body to remove excess lactic acid from the muscles.

1. Mount the Stepper, begin stepping, and press the **TRAINING TOOLS** key.
2. You are prompted to select the desired HR TRAINING program. Press the **1** key to select Interval Heart Rate Control.
3. You are prompted to enter your weight. The Stepper displays a default weight as set in Manager/Maintenance Mode. You may enter any weight from 1 to 350 pounds (1 to 158 kg).
 - Use the **0...9** keys to enter your current weight; or press the **▲** or **▼** key, as necessary, to increase or decrease the displayed weight in 1 pound (or 1 kg) increments.
 - When your correct weight has been entered, press the **OK** key to accept the displayed value.
4. You are prompted to enter a time goal. The Stepper displays a default time of 20 minutes, or equal to the time parameter set in Manager/Maintenance Mode if less than 20 minutes. You may enter any time from 1 to 99 minutes.
 - Use the **0...9** keys to enter the desired time goal, or press the **▲** or **▼** key, as necessary, to increase or decrease the displayed value in 1 minute increments.
 - When your desired time goal has been entered, press the **OK** key to accept the displayed value.
5. You are prompted to enter your age.
 - Use the **0...9** keys to enter your age, or press the **▲** or **▼** key, as necessary, to increase or decrease the displayed value in 1 year increments.

- When your correct age has been entered, press the **OK** key to accept the displayed value.
6. You are prompted to enter an upper heart rate limit. The Stepper displays a default upper heart rate limit that is based on 80% of your theoretical maximum heart rate (220 BPM - age). You may enter any value from 90 to 200 BPM.
 - Use the **0...9** keys to enter an upper heart rate limit, or press the **▲** or **▼** key, as desired, to increase or decrease the heart rate limit in 1 BPM increments.
 - When the desired upper heart rate limit has been entered, press the **OK** key to accept the displayed value.
 7. You are prompted to enter a lower heart rate limit. The Stepper displays a default lower heart rate limit that is based on 60% of your theoretical maximum heart rate (220 BPM - age). You may enter any value from 70 BPM to 20 BPM less than the upper heart rate limit set in step 6.
 - Use the **0...9** keys to enter a lower heart rate limit, or press the **▲** or **▼** key, as desired, to increase or decrease the heart rate limit in 1 BPM increments.
 - When the desired lower heart rate limit has been entered, press the **OK** key to accept the displayed value.
 8. If desired, you can use the personal fan during your workout (see “Using the Personal Fan” for details).
 9. You can scroll through workout data during the program (see “Viewing Workout Data During a Program” for details).
 10. If you wish to pause the program, stop stepping. The Stepper will enter pause mode and display your workout results for one entire cycle.
 11. When you have reached your workout goal, the Stepper enters the Cooldown cycle (see “Cooldown Cycle” for details). If you wish to exit the program before you have reached your workout goal, stop stepping and allow the Pause timer to expire.

To operate the CONSTANT HEART RATE Control program:

This heart rate feature is designed to maintain your heart rate at a constant level by controlling the difficulty level and prompting you to step at a specified speed. Please note that your heart rate may vary above and below your target heart rate during this program.















1. Mount the Stepper, begin stepping, and press the **TRAINING TOOLS** key.
2. You are prompted to select the desired HR TRAINING program. Press the **2** key to select Constant Heart Rate Control.
3. You are prompted to enter your weight. The Stepper displays a default weight as set in Manager/Maintenance Mode. You may enter any weight from 1 to 350 pounds (1 to 158 kg).
 - Use the **0...9** keys to enter your current weight; or press the **▲** or **▼** key, as necessary, to increase or decrease the displayed weight in 1 pound (or 1 kg) increments.
 - When your correct weight has been entered, press the **OK** key to accept the displayed value.
4. You are prompted to enter a time goal. The Stepper displays a default time of 20 minutes, or equal to the time parameter set in Manager/Maintenance Mode if less than 20 minutes. You may enter any time from 1 to 99 minutes.
 - Use the **0...9** keys to enter the desired time goal, or press the **▲** or **▼** key, as necessary, to increase or decrease the displayed value in 1 minute increments.
 - When your desired time goal has been entered, press the **OK** key to accept the displayed value.
5. You are prompted to enter your age.
 - Use the **0...9** keys to enter your age, or press the **▲** or **▼** key, as necessary, to increase or decrease the displayed value in 1 year increments.
 - When your correct age has been entered, press the **OK** key to accept the displayed value.
6. You are prompted to enter a target heart rate. The Stepper displays a default target heart rate that is based on 70% of your theoretical maximum heart rate (220 BPM - age). You may enter any value from 70 to 200 BPM.
 - Use the **0...9** keys to enter your target heart rate, or press the **▲** or **▼** key, as desired, to increase or decrease the target heart rate in 1 BPM increments.
 - When the desired target heart rate has been entered, press the **OK** key to accept the displayed value.
7. If desired, you can use the personal fan during your workout (see “Using the Personal Fan” for details).
8. You can scroll through workout data during the program (see “Viewing Workout Data During a Program” for details).
9. If you wish to pause the program, stop stepping. The Stepper will enter pause mode and display your workout results for one entire cycle.

10. When you have reached your workout goal, the Stepper enters the Cooldown cycle (see "Cooldown Cycle" for details). If you wish to exit the program before you have reached your workout goal, stop stepping and allow the Pause timer to expire.

FITNESS TEST

The FITNESS TEST program is designed to gradually elevate your heart rate to the upper end of your training range. The program begins with a three minute warm up cycle. Upon completion of the three minute warm up cycle, your heart rate is read and recorded. Based on this heart rate level the test progresses to the second stage, which correlates to your heart rate. This stage is one minute long. This procedure continues until two steady-state heart rates are obtained between 115-150 bpm. Upon completion of the test, your $VO_{2\max}$ is displayed in METS and in $mL \cdot kg^{-1} \cdot min^{-1}$. Based on your $VO_{2\max}$ score, your fitness level is also be displayed.

To operate the Fitness Test program:

1. Mount the Stepper, begin stepping, and press the  key.
2. You are prompted to select the desired HR TRAINING program. Press the  key to select Fitness Test.
3. You are prompted to enter your weight. The Stepper displays a default weight as set in Manager/Maintenance Mode. You may enter any weight from 1 to 350 pounds (1 to 158 kg).
 - Use the ... keys to enter your current weight; or press the  or  key, as necessary, to increase or decrease the displayed weight in 1 pound (or 1 kg) increments.
 - When your correct weight has been entered, press the  key to accept the displayed value.
4. You are prompted to enter your gender. Press the  key for male and the  key for female.
 - When your correct gender has been entered, press the  key to accept the displayed value.
5. You are prompted to enter your age.
 - Use the ... keys to enter your age, or press the  or  key, as necessary, to increase or decrease the displayed value in 1 year increments.
 - When your correct age has been entered, press the  key to accept the displayed value.
6. If desired, you can use the personal fan during your workout (see "Using the Personal Fan" for details).
7. You can scroll through workout data during the program (see "Viewing Workout Data During a Program" for details).
8. If you wish to pause the program, stop stepping. The Stepper will enter pause mode and display your workout results for one entire cycle.
9. When you have reached your workout goal, the Stepper enters the Cooldown cycle (see "Cooldown Cycle" for details). If you wish to exit the program before you have reached your workout goal, stop stepping and allow the Pause timer to expire.

PREVENTIVE MAINTENANCE

With durable, high performance components, the **STAR TRAC E-ST STEPPER** is designed for heavy usage with minimal maintenance required. To keep your Stepper in top condition, Star Trac strongly recommends performing the regular daily, weekly and monthly preventive maintenance routines outlined below. Any unusual symptoms, such as a loud continuous noise during operation, should be reported to **STAR TRAC PRODUCT SUPPORT DEPARTMENT** at (800) 503-1221, or USA 1-714-669-1660.

DAILY MAINTENANCE

- Remove excessive accumulations of dust, dirt, and other substances by using a clean, soft cloth and a non-abrasive liquid cleaner, such as Formula 409™ or FANTASTIK™. Wipe down the exterior of the display panel, hand rails, pedals, shrouds and heart rate grips.

NOTE: DO NOT spray the cleaner directly onto the Display Panel or heart rate grips.

WEEKLY MAINTENANCE

Perform the following services each week:

- Vacuum the floor under and around the **STAR TRAC E-ST STEPPER**. Move the **STAR TRAC E-ST STEPPER** to another spot, if necessary, to vacuum thoroughly.
- Inspect the Display Panel mounting screws for security, and retighten if necessary.
- Inspect the Display Panel keypads for wear.

MONTHLY MAINTENANCE

Perform the following services each month, or as needed:

- Check that the pedals and shrouds are secure.
- Check the hand rails for looseness. Tighten screws as necessary.
- Check for smooth and quiet operation of all moving parts.

REGULATORY INFORMATION

This section provides regulatory and safety information pertaining to the **STAR TRAC E-ST STEPPER**.

FCC AND OTHER DOMESTIC REGULATIONS

The Stepper has been tested and found to comply with the limits for a Class A digital device, pursuant to Part 15 Subpart B per CISPR 22 limits of FCC rules. Under FCC guidelines, operation is subject to the following two guidelines: (1) This device may not cause harmful interference, and (2) this device must accept any interference received, including interference that may cause undesired operation.

The Stepper generates and uses radio frequency energy. If the product is not installed and used in accordance with the instructions provided in the owner's manual, interference with radio communications may occur. Likewise, if unapproved accessories are installed, interference with radio communications may occur. The intent of the FCC class A limit is to provide reasonable protection against harmful interference in a commercial installation. However, there is no guarantee that interference may not occur in a specific installation. In the event that interference is experienced, turn off the unit to verify that it is the source. If the interference clears with the unit off, then try each of the following measures and combinations thereof:

- Reorient or relocate the Stepper.
- Reorient or relocate the receiving antenna for your television, radio or VCR.
- If using the wall outlet option, connect the unit to a different power outlet.
- Contact Star Trac Product Support, your authorized dealer, or a qualified radio/television technician for help.

This product has also been tested to meet the following standards:

- UL 1647 Motor Operated Massage and Exercise Machines

CANADIAN DOC AND OTHER REGULATIONS

This class A digital apparatus meets all requirements of the Canadian Interference Causing Equipment Regulations.

This product has also been tested to meet the following standards:

- CSA C22.2 No 0-M91 General Requirements
- CSA C22.2 No. 68-92 Motor Operated Appliances

EUROPEAN APPLICATIONS

This product has been tested to the following standards:

- EN 55022 Information technology equipment - Radio disturbance characteristics - Limits and methods of measurement
- EN 55024 Information technology equipment - Immunity characteristics - Limits and methods of measurement
- EN 60335-1 Safety of household and similar electrical appliances Part 1: General requirements
- EN 957-1 Safety of Machinery
- EN 957-8 Stepper specific safety requirements and test methods



expect different™.

STAR TRAC
14410 Myford Road
Irvine, California 92606
Telephone: (800) 228-6635, (714) 669-1660
Fax: (714) 508-3303
<http://www.startrac.com>
email: support@startrac.com

Free Manuals Download Website

<http://myh66.com>

<http://usermanuals.us>

<http://www.somanuals.com>

<http://www.4manuals.cc>

<http://www.manual-lib.com>

<http://www.404manual.com>

<http://www.luxmanual.com>

<http://aubethermostatmanual.com>

Golf course search by state

<http://golfingnear.com>

Email search by domain

<http://emailbydomain.com>

Auto manuals search

<http://auto.somanuals.com>

TV manuals search

<http://tv.somanuals.com>