MultiSync LCD2180UX

User's Manual

NEC

Index

Warning, Caution	English-1
Declaration	English-1
Canadian Department of Communications Compliance Statement	English-2
Declaration of Conformity	English-2
Contents	English-3
Quick Start	English-4
Controls	English-7
Recommended Use	English-10
Specifications	English-12
Features	English-13
Troubleshooting	English-14
Appendix	English-15
TCO'99	English-19
TCO'03	English-20
Manufacturer's Recycling and Energy Information	English-21

**WARNING**

TO PREVENT FIRE OR SHOCK HAZARDS, DO NOT EXPOSE THIS UNIT TO RAIN OR MOISTURE. ALSO, DO NOT USE THIS UNIT'S POLARIZED PLUG WITH AN EXTENSION CORD RECEPTACLE OR OTHER OUTLETS UNLESS THE PRONGS CAN BE FULLY INSERTED.

REFRAIN FROM OPENING THE CABINET AS THERE ARE HIGH VOLTAGE COMPONENTS INSIDE. REFER SERVICING TO QUALIFIED SERVICE PERSONNEL.

**CAUTION**

CAUTION: TO REDUCE THE RISK OF ELECTRIC SHOCK, MAKE SURE POWER CORD IS UNPLUGGED FROM WALL SOCKET. TO FULLY DISENGAGE THE POWER TO THE UNIT, PLEASE DISCONNECT THE POWER CORD FROM THE AC OUTLET. DO NOT REMOVE COVER (OR BACK). NO USER SERVICEABLE PARTS INSIDE. REFER SERVICING TO QUALIFIED SERVICE PERSONNEL.



This symbol warns user that uninsulated voltage within the unit may have sufficient magnitude to cause electric shock. Therefore, it is dangerous to make any kind of contact with any part inside this unit.



This symbol alerts the user that important literature concerning the operation and maintenance of this unit has been included. Therefore, it should be read carefully in order to avoid any problems.

Caution:

When operating the MultiSync LCD2180UX with a 220-240V AC power source in Europe, use the power cord provided with the monitor.

In the UK, a BS approved power cord with a moulded plug has a Black (five Amps) fuse installed for use with this equipment. If a power cord is not supplied with this equipment please contact your supplier.

When operating the MultiSync LCD2180UX with a 220-240V AC power source in Australia, use the power cord provided with the monitor. If a power cord is not supplied with this equipment please contact your supplier.

For all other cases, use a power cord that matches the AC voltage of the power outlet and has been approved by and complies with the safety standard of your particular country.

Declaration**Declaration of the Manufacturer**

We hereby certify that the colour monitor
MultiSync LCD2180UX (L213E9) is in
compliance with

Council Directive 73/23/EEC:
– EN 60950-1

Council Directive 89/336/EEC:
– EN 55022
– EN 61000-3-2
– EN 61000-3-3
– EN 55024

and marked with



NEC Display Solutions, Ltd.
4-13-23, Shibaura,
Minato-Ku
Tokyo 108-0023, Japan



Windows is a registered trademark of Microsoft Corporation. NEC is a registered trademark of NEC Corporation. ENERGY STAR is a U.S. registered trademark.

OmniColor is a registered trademark of NEC Display Solutions Europe GmbH in the countries of EU and Switzerland.

ErgoDesign is a registered trademark of NEC Display Solutions, Ltd. in Austria, Benelux, Denmark, France, Germany, Italy, Norway, Spain, Sweden, U.K.

NaViSet is a trademark of NEC Display Solutions Europe GmbH in the countries of EU and Switzerland.

All other brands and product names are trademarks or registered trademarks of their respective owners.

As an ENERGY STAR® Partner, NEC Display Solutions of America, Inc. has determined that this product meets the ENERGY STAR guidelines for energy efficiency. The ENERGY STAR emblem does not represent EPA endorsement of any product or service.

Canadian Department of Communications Compliance Statement

DOC: This Class B digital apparatus meets all requirements of the Canadian Interference-Causing Equipment Regulations.

C-UL: Bears the C-UL Mark and is in compliance with Canadian Safety Regulations according to CAN/CSA C22.2 No. 60950-1.

FCC Information

1. Use the attached specified cables with the MultiSync LCD2180UX (L213E9) colour monitor so as not to interfere with radio and television reception.

(1) The power supply cord you use must have been approved by and comply with the safety standards of U.S.A., and meet the following condition.

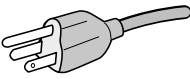
Power supply cord	Non shield type, 3-conductor
Length	2.0 m
Plug shape	
	U.S.A

(2) Please use the supplied shielded video signal cable, 15-pin mini D-SUB to DVI-A cable or DVI-D to DVI-D cable. Use of other cables and adapters may cause interference with radio and television reception.

2. This equipment has been tested and found to comply with the limits for a Class B digital device, pursuant to part 15 of the FCC Rules. These limits are designed to provide reasonable protection against harmful interference in a residential installation. This equipment generates, uses, and can radiate radio frequency energy, and, if not installed and used in accordance with the instructions, may cause harmful interference to radio communications. However, there is no guarantee that interference will not occur in a particular installation. If this equipment does cause harmful interference to radio or television reception, which can be determined by turning the equipment off and on, the user is encouraged to try to correct the interference by one or more of the following measures:

- Reorient or relocate the receiving antenna.
- Increase the separation between the equipment and receiver.
- Connect the equipment into an outlet on a circuit different from that to which the receiver is connected.
- Consult your dealer or an experienced radio/TV technician for help.

If necessary, the user should contact the dealer or an experienced radio/television technician for additional suggestions. The user may find the following booklet, prepared by the Federal Communications Commission, helpful: "How to Identify and Resolve Radio-TV Interference Problems." This booklet is available from the U.S. Government Printing Office, Washington, D.C., 20402, Stock No. 004-000-00345-4.

Declaration of Conformity

This device complies with Part 15 of FCC Rules. Operation is subject to the following two conditions. (1) This device may not cause harmful interference, and (2) this device must accept any interference received, including interference that may cause undesired operation.

U.S. Responsible Party:	NEC Display Solutions of America, Inc.
Address:	500 Park Blvd, Suite 1100 Itasca, Illinois 60143
Tel. No.:	(630) 467-3000

Type of Product:	Display Monitor
Equipment Classification:	Class B Peripheral
Model:	MultiSync LCD2180UX (L213E9)



We hereby declare that the equipment specified above conforms to the technical standards as specified in the FCC Rules.

Contents

Your new NEC MultiSync LCD monitor box* should contain the following:

- MultiSync LCD2180UX monitor with tilt/swivel/pivot/height adjust stand
- Power Cord
- Video Signal Cable (15-pin mini D-SUB male to DVI-A)
- Video Signal Cable (DVI-D to DVI-D cable)
- User's Manual
- CD-ROM
- Cable Cover

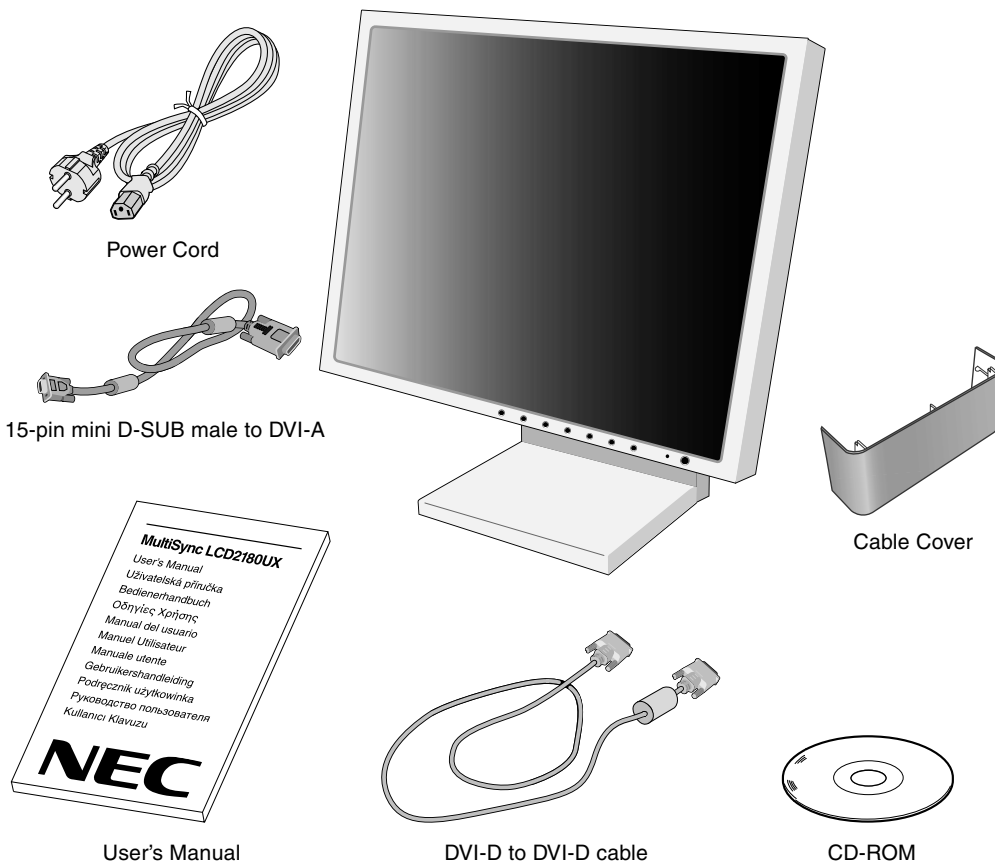

NOTE: This monitor can be equipped with optional loudspeakers: "MultiSync Sound bar". Please ask your dealer or check our website <http://www.nec-display-solutions.com>



* Remember to save your original box and packing material to transport or ship the monitor.

Quick Start

To attach the MultiSync LCD monitor to your system, follow these instructions:

1. Turn off the power to your computer.
2. **For the PC or MAC with DVI digital output:** Connect the DVI signal cable to the connector of the display card in your system (**Figure A.1**). Tighten all screws.
For the PC with Analog output: Connect the 15-pin mini D-SUB to DVI-A signal cable to the connector of the display card in your system (**Figure A.2**).
For the MAC: Connect the MultiSync Macintosh cable adapter to the computer, then attach the 15-pin mini D-SUB signal cable to the MultiSync Macintosh cable adapter (**Figure B.1**).

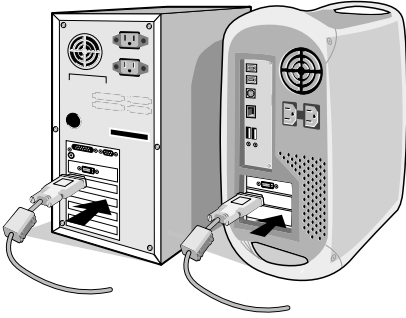
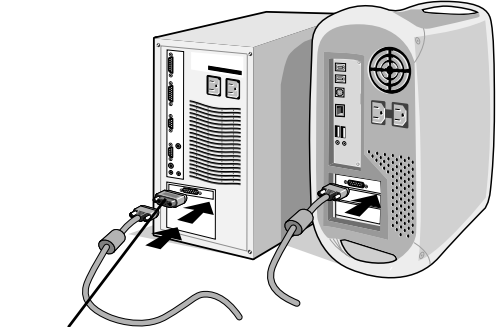

Figure A.1



Figure A.2



Macintosh
Cable Adapter
(not included)

Figure B.1

NOTE: Some Macintosh systems do not require a Macintosh cable adapter.

3. Connect the DVI signal cable to the connector on the back of the monitor. Place the video signal cable (**Figure C.1**). Connect only either VGA or DVI to input 2.

NOTE: Incorrect cable connections may result in irregular operation, damage display quality/components of LCD module and/or shorten the module's life.

Collect cables and keep them in the stand with attached cable cover. The cable cover can be attached on the front or back side of Tilt Stand (**Figure C.1, C.2**).

Please check Tilt, Rise and Lower monitor screen and screen rotation when you manage cables.

4. Connect one end of the power cord to the AC inlet on the back of the monitor and the other end to the power outlet (**Figure C.1**).

NOTE: Please refer to Caution section of this manual for proper selection of AC power cord.

5. The Vacation Switch on the left side of the monitor must be turned on. Turn on the monitor with the front power button (**Figure D.1**) and the computer.

NOTE: The Vacation Switch is a true on/off switch. If this switch is on the OFF position, the monitor cannot be turned on using the front button. DO NOT switch on/off repeatedly.

6. No-touch auto adjust automatically adjusts the monitor to optimal settings upon initial setup for most timings. For further adjustments, use the following OSM controls:

- Auto Contrast (Analog input only)
- Auto Adjust (Analog input only)

Refer to the **Controls** section of this User's Manual for a full description of these OSM controls.

NOTE: If you have any problems, please refer to the **Troubleshooting** section of this User's Manual.

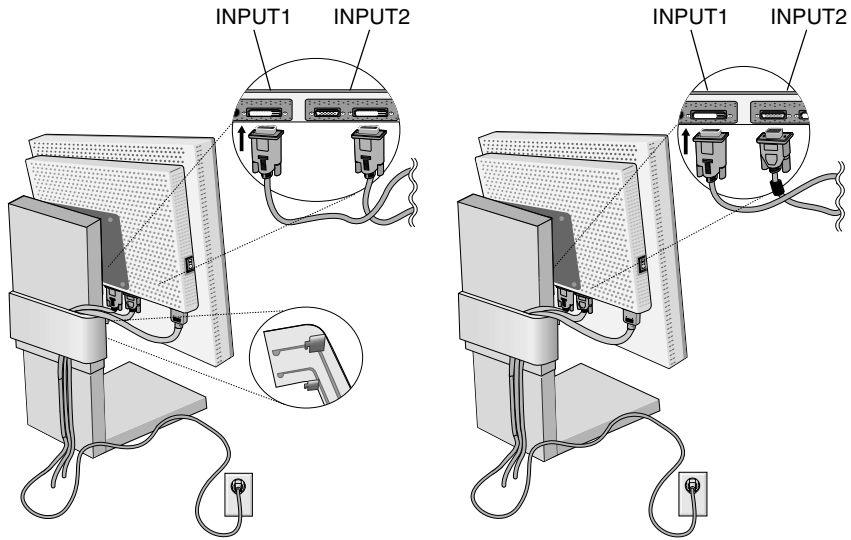

Figure C.1

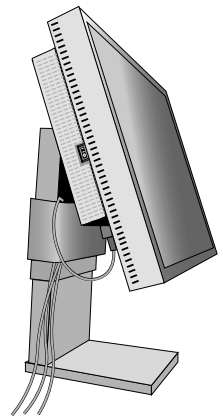
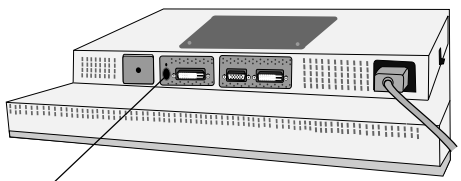
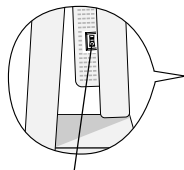

Figure C.2



NEC optional product attachment.
Do not use this connector unless specified.



Vacation Switch

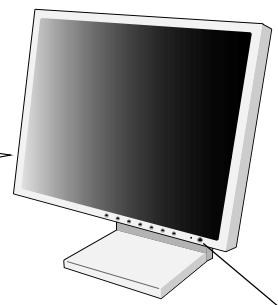

Power Button

Figure D.1

Raise and Lower Monitor Screen

The monitor may be raised or lowered in either Portrait or Landscape mode. To raise or lower screen, place hands on each side of the monitor and lift or lower to the desired height (**Figure RL.1**).

NOTE: Handle with care when raising or lowering the monitor screen.

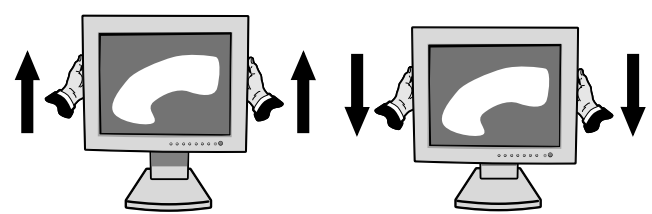

Figure RL.1

Screen Rotation

Before rotating, the screen must be raised to the highest level to avoid knocking the screen on the desk or pinching with your fingers.

To raise the screen, place hands on each side of the monitor and lift up to the highest position (**Figure RL.1**).

To rotate screen, place hands on each side of the monitor screen and turn clockwise from Landscape to Portrait or counter-clockwise from Portrait to Landscape (**Figure R.1**).

To rotate OSM menu between landscape and portrait, refer to "Controls" section, "OSM ROTATION" function.

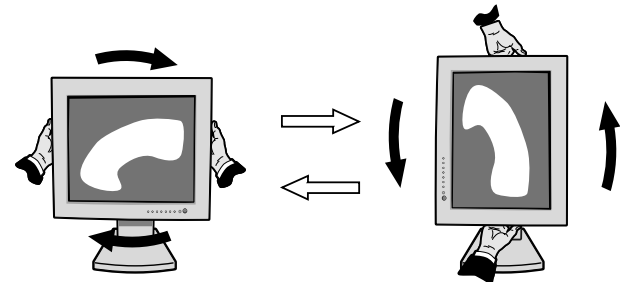

Figure R.1

Tilt

Grasp top and bottom sides of the monitor screen with your hands and adjust the tilt as desired (**Figure TS.1**).



Figure TS.1

Swivel

Grasp both sides of the monitor screen with your hands and adjust the swivel as desired (**Figure TS.2**).

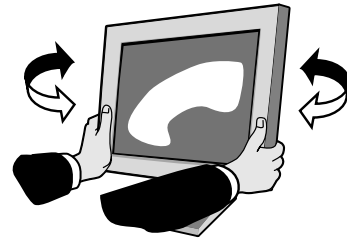

Figure TS.2

NOTE: Handle with care when tilting the monitor screen.

Remove Monitor Stand for Mounting

To prepare the monitor for alternate mounting purposes:

1. Disconnect all cables.
2. Place hands on each side of the monitor and lift up to the highest position.
3. Place monitor face down on a non-abrasive surface. (Place the screen on a 29 mm platform so that the stand is parallel with the surface) (**Figure S.1**).

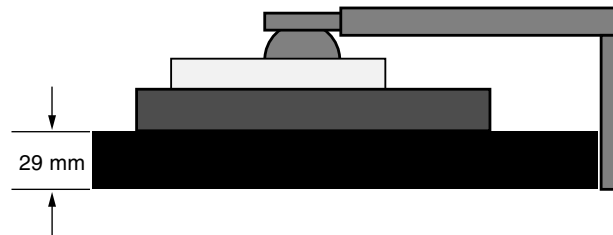

Figure S.1

4. Remove the two top screws connecting the monitor to the stand (**Figure S.2**). Turn the stand to 180° counterclockwise (you will hear two clicks). Remove the screws from the bottom (**Figure S.3**) and lift off the stand. The monitor is now ready for mounting in an alternate manner.
5. Reverse this process to reattach stand: tighten the two bottom screws, turn stand 180° counter clockwise (you will hear two clicks), and tighten two top screws.

NOTE: Use only VESA-compatible alternative mounting method (100 mm pitch).

NOTE: Handle with care when removing monitor stand.

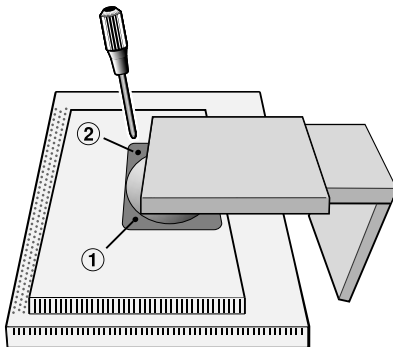

Figure S.2

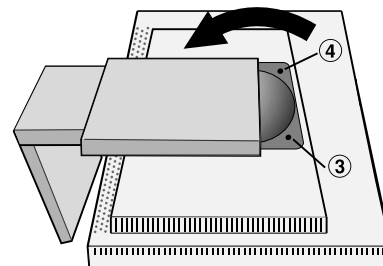

Figure S.3

Caution: Use the original screws (4 pcs) when mounting to avoid damage to the monitor and stand. To fulfil the safety requirements the monitor must be mounted to an arm which guarantees the necessary stability under consideration of the weight of the monitor. The LCD monitor should only be used with an approved arm (e.g. GS mark).

Controls

OSM (On-Screen Manager) control buttons on the front of the monitor function as follows:

To access OSM menu, press any of the control buttons (EXIT, ◀, ▶, -, +).
To change signal input, press the SELECT button.

NOTE: OSM must be closed in order to change signal input.

Menu

EXIT	Exits the OSM controls. Exits to the OSM main menu.
CONTROL ◀▶	Moves the highlighted area left/right to select control menus. Moves the highlighted area up/down to select one of the controls.
ADJUST - / +	Moves the bar left/right to increase or decrease the adjustment.
SELECT	Active Auto Adjust function. Enter the OSM controls. Enter the OSM sub menu.
RESET	Resets the highlighted control menu to the factory setting.

NOTE: When **RESET** is pressed in the main and sub-menu, a warning window will appear allowing you to cancel the **RESET** function by pressing the EXIT button.

☀️🌑 Brightness/Contrast Controls



BRIGHTNESS

Adjusts the overall image and background screen brightness.



CONTRAST

Adjusts the image brightness in relation to the background.



AUTO CONTRAST (Analog input only)

Adjusts the image displayed for non-standard video inputs.



AUTO BRIGHTNESS

This function adjusts the brightness automatically for the best CONTRAST and BRIGHTNESS setting based on the white display area.

AUTO Auto Adjust (Analog input only)

Automatically adjusts the Image Position and H. Size settings and Fine settings.

🖥️↔️ Image Controls



LEFT / RIGHT

Controls Horizontal Image Position within the display area of the LCD.



DOWN / UP

Controls Vertical Image Position within the display area of the LCD.



H.SIZE (Analog input only)

Adjusts the horizontal size by increasing or decreasing this setting.

If the "AUTO Adjust function" do not give you a satisfactory picture setting, a further tuning can be performed using the "H.Size" function (dot clock). For this a Moiré test pattern could be used. This function may alter the width of the picture. Use Left/Right Menu to center the image on the screen. If the H.Size is wrongly calibrated, the result would look like on the left drawing. The image should be homogeneous.





FINE (Analog input only)

Improves focus, clarity and image stability by increasing or decreasing this setting.

If the "Auto Adjust function" and the "H.Size" function do not give you a satisfactory picture setting, a fine tuning can be performed using the "Fine" function. It improves focus, clarity and image stability by increasing or decreasing this setting.

For this a Moiré test pattern could be used. If the Fine value is wrongly calibrated, the result would look like on the left drawing. The image should be homogeneous.

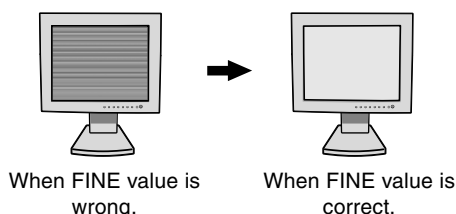

Colour Control Systems

Colour Control Systems: Six colour presets select the desired colour setting (sRGB, NATIVE and PROGRAMMABLE colour presets are standard and cannot be changed). Colour temperature increases or decreases, in each preset.

R,Y,G,C,B,M,S: Increases or decreases Red, Yellow, Green, Cyan, Blue, Magenta and Saturation depending upon which is selected. The change in colour will appear on screen and the direction (increase or decrease) will be shown by the colour bars.

NATIVE: Original colour presented by the LCD panel that is unadjustable.

PROGRAMMABLE: The colour tone that was set up with the downloaded application software is reflected.



Tools 1



SHARPNESS: This function is digitally capable to keep crisp image at any timings. It is continuously adjustable to get distinct image or soft one as you prefer, and set independently by different timings.

The number of adjustment steps is different depending on whether EXPANSION Mode is OFF, FULL or ASPECT (1600 x 1200 is OFF Mode).



EXPANSION MODE: Sets the zoom method.

FULL: The image is expanded to 1600 x 1200, regardless of the resolution.

ASPECT: The image is expanded without changing the aspect ratio.

OFF: The image is not expanded.

CUSTOM (Digital input and Resolution of 1600 x 1200 only):

Select one of nine expansion rates. In this mode the resolution may be low and there may be blank areas. This mode is for use with special video cards.



VIDEO DETECT: Selects the method of video detection when more than one computer is connected.

FIRST DETECT: The video input has to be switched to "FIRST DETECT" mode. When current video input signal is not present, then the monitor searches for a video signal from the other video input port. If the video signal is present in the other port, then the monitor switches the video source input port to the new found video source automatically. The monitor will not look for other video signals while the current video source is present.

LAST DETECT: The video input has to be switched to the "LAST DETECT" mode. When the monitor is displaying a signal from the current source and a new secondary source is supplied to the monitor, then the monitor will automatically switch to the new video source. When current video input signal is not present, then the monitor searches for a video signal from the other video input port. If the video signal is present in the other port, then the monitor switches the video source input port to the new found video source automatically.

NONE: The Monitor will not search the other video input port unless the monitor is turned on.



DVI SELECTION: This function selects the DVI input mode (Input 1). When the DVI selection has been changed, the computer has to be restarted.

AUTO: By using the DVI-D to DVI-D cable, the DVI SELECTION is DIGITAL.

By using the D-SUB to DVI-A cable, the DVI SELECTION is ANALOG.

DIGITAL: DVI digital input is available.

ANALOG: DVI analog input is available.

Note: For the MAC with digital output: Before turning on the MAC, the DVI Input mode must be set to DIGITAL in "DVI SELECTION" of OSM by pressing "SELECT" button then "CONTROL" button when the DVI signal cable is connected to the DVI-I connector (Input1) of the monitor. Otherwise the MAC may not turn on.

Note: Depending on the PC and Video card used, or when another Video signal cable is attached, this function may not operate.



OFF TIMER: Monitor will automatically power-down when the end user has selected a pre-determined amount of time.



Tools 2



LANGUAGE: OSM control menus are available in seven languages.



OSM LEFT/RIGHT: You can choose where you would like the OSM control image to appear on your screen. Selecting OSM Location allows you to manually adjust the position of the OSM control menu left or right.



OSM DOWN/UP: You can choose where you would like the OSM control image to appear on your screen. Selecting OSM Location allows you to manually adjust the position of the OSM control menu down or up.



OSM TURN OFF: The OSM control menu will stay on as long as it is use. In the OSM Turn Off submenu, you can select how long the monitor waits after the last touch of a button to shut off the OSM control menu. The preset choices are 10-120 seconds by 5 seconds step.



OSM LOCK OUT: This control completely locks out access to all OSM control functions. When attempting to activate OSM controls while in the Lock Out mode, a screen will appear indicating the OSM controls are locked out. There are two types of OSM LOCK OUT:

OSM LOCK OUT with BRIGHTNESS and CONTRAST control: To activate the OSM Lock Out function, press SELECT, then “+” key and hold down simultaneously. To deactivate the OSM Lock Out, press SELECT, then “+” key and hold down simultaneously. BRIGHTNESS and CONTRAST can be adjusted while in the lock out mode.

OSM LOCK OUT with no control: To activate the OSM Lock Out function, press SELECT, then “>” key and hold down simultaneously. To deactivate the OSM Lock Out, press SELECT, then “>” key and hold down simultaneously. No controls can be adjusted while in the lock out mode.



OSM ROTATION: To rotate OSM between Landscape and Portrait modes.



RESOLUTION NOTIFIER: This optimal resolution is 1600 x 1200. If ON is selected, a message will appear on the screen after 30 seconds, notifying you that the resolution is not at 1600 x 1200.



HOT KEY: You can adjust the brightness and contrast directly. When this function is set to ON, you can adjust the brightness with ◀ or ▶, contrast with + or - key, while the OSM menu is off. The standard OSM can be accessed with the EXIT button.



FACTORY PRESET: Selecting Factory Preset allows you to reset all OSM control settings (BRIGHTNESS, CONTRAST, IMAGE CONTROL, COLOUR CONTROL SYSTEM, SHARPNESS, EXPANSION MODE, OFF TIMER, OSM LEFT/RIGHT, OSM DOWN/UP, OSM TURN OFF, DISPLAY MODE) back to the factory settings. Individual settings can be reset by highlighting the control to be reset and pressing the RESET button.



Information

MODE

DISPLAY MODE: Provides information about the current resolution display and technical data including the preset timing being used and the horizontal and vertical frequencies. Increases or decreases the current resolution.



MONITOR INFO.: Indicates the model and serial numbers of your monitor.

OSM Warning

OSM Warning menus disappear with Exit button.

NO SIGNAL: This function gives a warning when there is no Horizontal or Vertical Sync. After power is turned on or when there is a change of input signal, the **No Signal** window will appear.

RESOLUTION NOTIFIER: This function gives a warning of use with optimized resolution. After power is turned on or when there is a change of input signal or the video signal doesn't have proper resolution, the **Resolution Notifier** window will open. This function can be disabled in the TOOL menu.

OUT OF RANGE: This function gives a recommendation of the optimized resolution and refresh rate. After the power is turned on or there is a change of input signal or the video signal doesn't have proper timing, the **Out Of Range** menu will appear.

NOTE: If “**i** CHANGE DVI SELECTION” is displayed, switch to DVI SELECTION.

For advanced user menu see “Appendix”.

Recommended use

Safety Precautions and Maintenance



FOR OPTIMUM PERFORMANCE, PLEASE NOTE
THE FOLLOWING WHEN SETTING UP AND USING
THE MULTISYNC LCD COLOUR MONITOR:



- **DO NOT OPEN THE MONITOR.** There are no user serviceable parts inside and opening or removing covers may expose you to dangerous shock hazards or other risks. Refer all servicing to qualified service personnel.
- Do not spill any liquids into the cabinet or use your monitor near water.
- Do not insert objects of any kind into the cabinet slots, as they may touch dangerous voltage points, which can be harmful or fatal or may cause electric shock, fire or equipment failure.
- Do not place any heavy objects on the power cord. Damage to the cord may cause shock or fire.
- Do not place this product on a sloping or unstable cart, stand or table, as the monitor may fall, causing serious damage to the monitor.
- Do not place any objects onto the monitor and do not use the monitor outdoors.
- The inside of the fluorescent tube located within the LCD monitor contains mercury. Please follow the bylaws or rules of your municipality to dispose of the tube properly.

Immediately unplug your monitor from the wall outlet and refer servicing to qualified service personnel under the following conditions:

- When the power supply cord or plug is damaged.
- If liquid has been spilled, or objects have fallen into the monitor.
- If the monitor has been exposed to rain or water.
- If the monitor has been dropped or the cabinet damaged.
- If the monitor does not operate normally by following operating instructions.
- Do not bend power cord.
- Do not use monitor in high temperature, humid, dusty, or oily areas.
- If glass is broken, handle with care.
- Do not cover vent on monitor.
- If monitor or glass is broken, do not come in contact with the liquid crystal and handle with care.



CAUTION

- Allow adequate ventilation around the monitor so that heat can properly dissipate. Do not block ventilated openings or place the monitor near a radiator or other heat sources. Do not put anything on top of monitor.
 - The power cable connector is the primary means of detaching the system from the power supply. The monitor should be installed close to a power outlet which is easily accessible.
 - Handle with care when transporting. Save packaging for transporting.
- **Image Persistence:** Image persistence is when a residual or "ghost" image of a previous image remains visible on the screen. Unlike CRT monitors, LCD monitors' image persistence is not permanent, but constant images being displayed for a long period of time should be avoided.

To alleviate image persistence, turn off the monitor for as long as the previous image was displayed. For example, if an image was on the monitor for one hour and a residual image remains, the monitor should be turned off for one hour to erase the image.

NOTE: As with all personal display devices, NEC DISPLAY SOLUTIONS recommends using a moving screen saver at regular intervals whenever the screen is idle or turning off the monitor when not in use.



CORRECT PLACEMENT AND ADJUSTMENT OF THE MONITOR CAN REDUCE EYE, SHOULDER AND NECK FATIGUE. CHECK THE FOLLOWING WHEN YOU POSITION THE MONITOR:



- For optimum performance, allow 20 minutes for warm-up.
- Adjust the monitor height so that the top of the screen is at or slightly below eye level. Your eyes should look slightly downward when viewing the middle of the screen.
- Position your monitor no closer than 40 cm and no further away than 70 cm from your eyes. The optimal distance is 50 cm.
- Rest your eyes periodically by focusing on an object at least 20 feet away. Blink often.
- Position the monitor at a 90° angle to windows and other light sources to minimize glare and reflections. Adjust the monitor tilt so that ceiling lights do not reflect on your screen.
- If reflected light makes it hard for you to see your screen, use an anti-glare filter.
- Clean the LCD monitor surface with a lint-free, non-abrasive cloth. Case of persistent dirt, wipe with cloth permeated by water, ethanol, isopropyl-alcohol completely. Avoid using any cleaning solution or glass cleaner (ex Acid, Alkali and Acetone).
- Adjust the monitor's brightness and contrast controls to enhance readability.
- Use a document holder placed close to the screen.
- Position whatever you are looking at most of the time (the screen or reference material) directly in front of you to minimize turning your head while you are typing.
- Avoid displaying fixed patterns on the monitor for long periods of time to avoid image persistence (after-image effects).
- Get regular eye checkups.

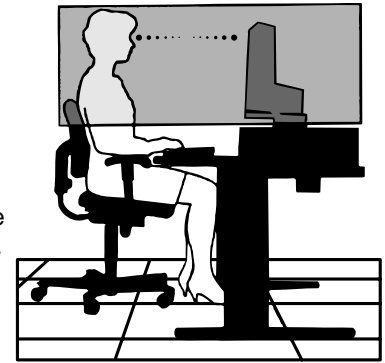

Ergonomics

To realize the maximum ergonomics benefits, we recommend the following:

- Adjust the Brightness until the background raster disappears.
- Do not position the Contrast control to its maximum setting.
- Use the preset Size and Position controls with standard signals.
- Use the preset Colour Setting.
- Use non-interlaced signals with a vertical refresh rate more than 60 Hz.
- Do not use primary colour blue on a dark background, as it is difficult to see and may produce eye fatigue to insufficient contrast.

Specifications

Monitor Specifications		MultiSync LCD2180UX Monitor	Notes
LCD Module	Diagonal: Viewable Image Size: Native Resolution (Pixel Count):	54 cm/21.3 inches 54 cm/21.3 inches 1600 x 1200	Active matrix; thin film transistor (TFT) liquid crystal display (LCD); 0.270 mm dot pitch; 250 cd/m ² white luminance; 500:1 contrast ratio, typical.
Input Signal	Video: Sync:	ANALOG 0.7 Vp-p/75 Ohms Separate sync.TTL Level Horizontal sync. Positive/Negative Vertical sync. Positive/Negative Composite sync. Positive/Negative Sync on Green (Video 0.7V p-p and Sync Negative 0.3V p-p)	Digital Input: DVI
Display Colours		16,777,216	Depends on display card used.
Synchronization Range	Horizontal: Vertical:	31.5 kHz to 91.1 kHz 50 Hz to 85 Hz	Automatically Automatically
Viewing Angle	Left/Right: Up/Down:	±88° (CR > 10) ±88° (CR > 10)	
Image Formation Time		20 ms (Typ.)	
Resolutions Supported	Landscape: Portrait:	720 x 400*1 : VGA-Text 640 x 480*1 at 60 Hz to 85 Hz 800 x 600*1 at 56 Hz to 85 Hz 832 x 624*1 at 75 Hz 1024 x 768*1 at 60 Hz to 85 Hz 1152 x 870*1 at 75 Hz 1280 x 1024*1 at 60 Hz to 85 Hz 1600 x 1200 at 60 Hz..... 480 x 640*1 at 60 Hz to 85 Hz 600 x 800*1 at 56 Hz to 85 Hz 624 x 832*1 at 75 Hz 768 x 1024*1 at 60 Hz to 85 Hz 870 x 1152*1 at 75 Hz 1024 x 1280*1 at 60 Hz to 85 Hz 1200 x 1600 at 60 Hz.....	Some systems may not support all modes listed. NEC DISPLAY SOLUTIONS cites recommended resolution for optimal display performance. Some systems may not support all modes listed. NEC DISPLAY SOLUTIONS cites recommended resolution for optimal display performance.
Active Display Area	Landscape: Horiz.: Vert.: Portrait: Horiz.: Vert.:	432 mm/17.0 inches 324 mm/12.8 inches 324 mm/12.8 inches 432 mm/17.0 inches	
Power Supply		AC 100-240 V ~ 50/60 Hz	
Current Rating		0.6 - 0.3 A	
Dimensions	Landscape: Portrait: Height Adjustment:	467 mm (W) x 391 - 506 mm (H) x 200 mm (D) 18.4 inches (W) x 15.4 - 19.9 inches (H) x 7.9 inches (D) 358.7 mm (W) x 483.3 - 560.2 mm (H) x 200 mm (D) 14.1 inches (W) x 19.0 - 22.1 inches (H) x 7.9 inches (D) 115 mm/4.5 inches (Landscape)	
Weight		11.0 kg (24.3 lbs)	
Environmental Considerations	Operating Temperature: Humidity: Feet: Storage Temperature: Humidity: Feet:	5°C to 35°C/41°F to 95°F 30% to 80% 0 to 15,900 Feet/0 to 4,850 m -10°C to 60°C/14°F to 140°F 10% to 85% 0 to 44,600 Feet/0 to 13,600 m	

*1 Interpolated Resolutions: When resolutions are shown that are lower than the pixel count of the LCD module, text may appear different. This is normal and necessary for all current flat panel technologies when displaying non-native resolutions full screen. In flat panel technologies, each dot on the screen is actually one pixel, so to expand resolutions to full screen, an interpolation of the resolution must be done.

NOTE: Technical specifications are subject to change without notice.

Features

ambix Technology: Dual input technology allowing both analog and digital inputs off of one connector (DVI-I) as well as additional legacy analog support off of a traditional 15-pin VGA connector. Provides traditional MultiSync technology compatibility for analog as well as DVI-based digital compatibility for digital inputs. DVI-based digital interfaces include DVI-D, DFP and P&D.

DVI-I: The integrated interface ratified by the Digital Display Working Group (DDWG) that allows both digital and analog connectors off of one port. The "I" stands for integration for both digital and analog, The digital portion is DVI-based.

DVI-D: The digital-only subset of DVI ratified by the Digital Display Working Group (DDWG) for digital connections between computers and displays. As a digital-only connector, analog support is not provided off a DVI-D connector. As a DVI-based digital only connection, only a simple adapter is necessary for compatibility between DVI-D and other DVI-based digital connectors such as DFP and P&D.

DFP (Digital Flat Panel): An all-digital interface for flat panel monitors which is signal compatible with DVI. As a DVI-based digital only connection, only a simple adapter is necessary for compatibility between DFP and other DVI-based digital connectors such as DVI and P&D.

P&D (Plug and Display): The VESA standard for digital flat panel monitor interfaces. It is more robust than DFP since it allows for other options off a signal connector (options like USB, analog video and IEEE-1394-995). The VESA committee has recognized that DFP is a subset of P&D. As a DVI-based connector (for the digital input pins), only a simple adapter is necessary for compatibility between P&D and other DVI-based digital connector such as DVI and DFP.

Pivoting Stand: Allows users to adjust the monitor to the orientation that best fits their application, either Landscape orientation for wide documents, or portrait orientation for the ability to preview a full page on one screen at one time. The Portrait orientation is also perfect for full screen video conferencing.

Reduced Footprint: Provides the ideal solution for environments requiring superior image quality but with size and weight limitations. The monitor's small footprint and low weight allow it to be moved or transported easily from one location to another.

Colour Control Systems: Allows you to adjust the colours on your screen and customize the colour accuracy of your monitor to a variety of standards.

OmniColor: Combines Six-axis colour control and the sRGB standard. Six-axis colour control permits colour adjustments via six axes (R, G, B, C, M and Y) rather than through the three axes (R, G and B) previously available. The sRGB standard provides the monitor with a uniform colour profile. This assures that the colours displayed on the monitor are exactly the same as on the colour printout (with sRGB supporting operating system and sRGB printer). This allows you to adjust the colours on your screen and customise the colour accuracy of your monitor to a variety of standards.

OSM (On-Screen Manager) Controls: Allow you to quickly and easily adjust all elements of your screen image via simple to use on-screen menus.

ErgoDesign Features: Enhance human ergonomics to improve the working environment, protect the health of the user and save money. Examples include OSM controls for quick and easy image adjustments, tilt base for preferred angle of vision, small footprint and compliance with MPRII and TCO guidelines for lower emissions.

New Anti-Glaring and Low Reflection: Glaring impression and ambient reflection was restrained by "New Anti-Glaring and Low Reflection". As a result, BLACK level is restrained, and you can get more clear image.

Plug and Play: The Microsoft® solution with the Windows® 95/98/2000/Me/XP operating system facilitates setup and installation by allowing the monitor to send its capabilities (such as screen size and resolutions supported) directly to your computer, automatically optimizing display performance.

IPM (Intelligent Power Manager) System: Provides innovative power-saving methods that allow the monitor to shift to a lower power consumption level when on but not in use, saving two-thirds of your monitor energy costs, reducing emissions and lowering the air conditioning costs of the workplace.

Multiple Frequency Technology: Automatically adjusts monitor to the display card's scanning frequency, thus displaying the resolution required.

FullScan Capability: Allows you to use the entire screen area in most resolutions, significantly expanding image size.

Wide Viewing Angle Technology: Allows the user to be able to see the monitor from any angle (176 degrees) from any orientation — Portrait or Landscape. Provides full 176° viewing angles either up, down, left or right.

VESA Standard Mounting Interface: Allows users to connect their MultiSync monitor to any VESA standard third party mounting arm or bracket. Allows for the monitor to be mounted on a wall or an arm using any third party compliant device.

NaViSet: Is a ground-breaking software family, developed by NEC Display Solutions Europe GmbH, providing intuitive access to all monitor setting controls and remote diagnosis via the Windows interface, based upon the VESA standard, DDC/CI. Using a standard VGA or DVI signal cable, NaViSet can either benefit single users or, with NaViSet Administrator, can reduce the Total Cost of Ownership through remote network-wide maintenance, diagnosis and asset-reporting.

CableComp automatic long cable compensation prevents image quality degradation caused by long cable lengths.

No-touch Auto Adjust (Analog input only): No-touch auto adjust automatically adjusts the monitor to optimal settings upon initial setup.

sRGB Colour Control: A new optimized colour management standard which allows for colour matching on computer displays and other peripherals. The sRGB, which is based on the calibrated colour space, allows for optimal colour representation and backward compatibility with other common colour standards.

Troubleshooting

No picture

- The signal cable should be completely connected to the display card/computer.
- The display card should be completely seated in its slot.
- Check the Vacation Switch should be in the ON position.
- Front Power Switch and computer power switch should be in the ON position.
- Check to make sure that a supported mode has been selected on the display card or system being used. (Please consult display card or system manual to change graphics mode.)
- Check the monitor and your display card with respect to compatibility and recommended settings.
- Check the signal cable connector for bent or pushed-in pins.
- Check the signal input, "INPUT 1" or "INPUT 2".
- Ensure the DVI input mode is set to DIGITAL when the MAC digital output is connected to the DVI-I (Input1) connector.

Power Button does not respond

- Unplug the power cord of the monitor from the AC outlet to turn off and reset the monitor.
- Check the Vacation Switch on the left side of the monitor.

Image Persistence

- Image persistence is when a residual or "ghost" image of a previous image remains visible on the screen. Unlike CRT monitors, LCD monitors' image persistence is not permanent, but constant images being displayed for a long period of time should be avoided. To alleviate image persistence, turn off the monitor for as long as the previous image was displayed. For example, if an image was on the monitor for one hour and a residual image remains, the monitor should be turned off for one hour to erase the image.

NOTE: As with all personal display devices, NEC DISPLAY SOLUTIONS recommends using a moving screen saver at regular intervals whenever the screen is idle or turning off the monitor when not in use.

Message "OUT OF RANGE" is displayed (screen is either blank or shows rough images only)

- Image is displayed only roughly (pixels are missing) and OSM warning "OUT OF RANGE" is displayed: Either signal clock or resolution is too high. Choose one of the supported modes.
- OSM warning "OUT OF RANGE" is displayed on a blank screen: Signal frequency is out of range. Choose one of the supported modes.

Image is unstable, unfocused or swimming is apparent

- Signal cable should be completely attached to the computer.
- Use the OSM Image Adjust controls to focus and adjust display by increasing or decreasing the fine total. When the display mode is changed, the OSM Image Adjust settings may need to be readjusted.
- Check the monitor and your display card with respect to compatibility and recommended signal timings.
- If your text is garbled, change the video mode to non-interlace and use 60Hz refresh rate.

LED on monitor is not lit (*no green or amber colour can be seen*)

- Power Switch should be in the ON position and power cord should be connected.

Display image is not sized properly

- Use the OSM Image Adjust controls to increase or decrease the Coarse total.
- Check to make sure that a supported mode has been selected on the display card or system being used. (Please consult display card or system manual to change graphics mode.)

No Video

- If no video is present on the screen, turn the Power button off and on again.
- Make certain the computer is not in a power-saving mode (touch the keyboard or mouse).

No tilt

- Rotate the screen to 90° clockwise until you hear one click.
- Refer to the Quick Start section, "Remove monitor stand for mounting" to insure correct installation of stand.

Appendix

If you need detailed information about the controls, please use the advanced menu.

<How to use the advanced menu>

- Turn off your monitor.
- Turn on your monitor by pushing the “POWER” and “SELECT” button at the same time for at least one second simultaneously.
- You will see the Advanced menu.
This menu is larger than the normal OSM.

<How to exit the advanced menu>

- Turn off and restart your monitor in the normal way.

To make an adjustment, ensure that the tag is highlighted, then press “SELECT”.

To move to another tag, press “EXIT”, then press “◀” or “▶” to highlight another tag.

Tag1	Brightness	Adjusts the overall image and screen background brightness. Press “+” or “-” to adjust.																									
	Contrast	Adjusts the image brightness and contrast in relation to the background. Press “+” or “-” to adjust.																									
	Auto Black Level (Analog input only)	Automatically adjusts the black level. Any adjustment requires the image to have black portions. (Ensure that the image has 64 or more adjacent black dots before making an adjustment). Press “SELECT” to activate Auto Adjust.																									
	Auto Contrast (Analog input only)	Adjusts the image displayed for non-standard video inputs. Press “SELECT” to adjust. Any adjustment requires the image to have white portions.																									
	Black Level (Analog input only)	Adjusts the black level. Press “+” or “-” to select.																									
	Auto Brightness	This function adjusts the brightness automatically for the best CONTRAST and BRIGHTNESS setting based on the white display area.																									
Tag2	R-H.position (Analog input only)	Adjusts the position of the red component of the image. Press “+” or “-” to adjust.																									
	G-H.position (Analog input only)	Adjusts the position of the green component of the image. Press “+” or “-” to adjust.																									
	B-H.position (Analog input only)	Adjusts the position of the blue component of the image. Press “+” or “-” to adjust.																									
	R-SHARPNESS (Analog input only)	Adjusts the sharpness of the red component of the image. Press “+” or “-” to adjust.																									
	G-SHARPNESS (Analog input only)	Adjusts the sharpness of the green component of the image. Press “+” or “-” to adjust.																									
	B-SHARPNESS (Analog input only)	Adjusts the sharpness of the blue component of the image. Press “+” or “-” to adjust.																									
Tag3	Signal (Analog input only)	Determines when the auto adjustment is activated automatically. The choices are “OFF”, “SIMPLE” and “FULL”. Press “+” or “-” to select.																									
	<table border="1"> <thead> <tr> <th rowspan="2">SIGNAL setting</th> <th colspan="2">Input Signal</th> <th colspan="2">Adjustment Items</th> </tr> <tr> <th>New</th> <th>Re-input</th> <th>H-size, Fine, H/V-Position</th> <th>Contrast</th> </tr> </thead> <tbody> <tr> <td>OFF</td> <td>O</td> <td>X</td> <td>*</td> <td>-</td> </tr> <tr> <td>SIMPLE</td> <td>O</td> <td>O</td> <td>*</td> <td>-</td> </tr> <tr> <td>FULL</td> <td>O</td> <td>O</td> <td>*</td> <td>*</td> </tr> </tbody> </table>	SIGNAL setting	Input Signal		Adjustment Items		New	Re-input	H-size, Fine, H/V-Position	Contrast	OFF	O	X	*	-	SIMPLE	O	O	*	-	FULL	O	O	*	*	O: automatical adjustment is performed about the items filled *. X: automatical adjustment is not performed. Notice: Automatical adjustment dose not work at less than 800x600 resolution.	
SIGNAL setting	Input Signal		Adjustment Items																								
	New	Re-input	H-size, Fine, H/V-Position	Contrast																							
OFF	O	X	*	-																							
SIMPLE	O	O	*	-																							
FULL	O	O	*	*																							

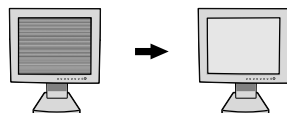
	Auto SW (Analog input only)	Determines the automatic adjustment level for Auto Adjust. The choices are "SIMPLE", "FULL" and "DETAIL". Press "+" or "-" to select. Refer to the below table. Determines the automatic adjustment level as shown in the below table.																				
		<table border="1"> <thead> <tr> <th></th> <th>Size, Fine, Position</th> <th>Contrast</th> <th>Black Level, Long cable capability*1</th> <th>Time</th> </tr> </thead> <tbody> <tr> <td>SIMPLE</td> <td>O</td> <td>X</td> <td>X</td> <td>1.5 seconds</td> </tr> <tr> <td>FULL</td> <td>O</td> <td>O</td> <td>X</td> <td>2 seconds</td> </tr> <tr> <td>DETAIL</td> <td>O</td> <td>O</td> <td>O</td> <td>10 to 20 seconds</td> </tr> </tbody> </table> <p>*1: Black level, RGB sharpness, RGB delay and RGB position are adjusted using "Long cable software" which is included in the attached CD-ROM.</p>		Size, Fine, Position	Contrast	Black Level, Long cable capability*1	Time	SIMPLE	O	X	X	1.5 seconds	FULL	O	O	X	2 seconds	DETAIL	O	O	O	10 to 20 seconds
	Size, Fine, Position	Contrast	Black Level, Long cable capability*1	Time																		
SIMPLE	O	X	X	1.5 seconds																		
FULL	O	O	X	2 seconds																		
DETAIL	O	O	O	10 to 20 seconds																		
Tag4	Auto (Analog input only)	Automatically adjusts the Image Position and H. Size settings and Fine settings. Press "SELECT" to activate Auto Adjustment.																				
	H. Position	Controls Horizontal Image Position within the display area of the LCD. Press "+" or "-" to adjust.																				
	V. Position	Controls Vertical Image Position within the display area of the LCD. Press "+" or "-" to adjust.																				
	H. Size (Analog input only)	Adjusts the horizontal size of the screen. If the "AUTO Adjust function" do not give you a satisfactory picture setting, a further tuning can be performed using the "H.Size" function (dot clock). For this a Moiré test pattern could be used. This function may alter the width of the picture. Use left/Right Menu to center the image on the screen. If the H.Size is wrongly calibrated, the result would look like on the left drawing. The image should be homogeneous.  <p style="text-align: center;">When H.SIZE value is wrong. When H.SIZE value is improved. When H.SIZE value is correct.</p>																				
Fine (Analog input only)	Improve focus, clarity and image stability by increasing or decreasing this setting. If the "Auto Adjust function" and the "H.Size" function do not give you a satisfactory picture setting, a fine tuning can be performed using the "Fine" function. It improves focus, clarity and image stability by increasing or decreasing this setting. For this a Moiré test pattern could be used. If the Fine value is wrongly calibrated, the result would look like on the left drawing. The image should be homogeneous.  <p style="text-align: center;">When FINE value is wrong. When FINE value is correct.</p>																					
Tag5	Gamma Selection	Allows you to manually select the brightness level of greyscale. There are five selections: NO CORRECTION, 2.2, OPTION, PROGRAMMABLE and CUSTOM. NO CORRECTION: No Correction possible. 2.2: The value is fixed at 2.2. OPTION: There are two ways of OPTION selection. 1: This setting is recommended for Video source. Grey area looks much brighter than NO CORRECTION setting. 2: The value near DICOM gamma is set up in a factory and the luminosity difference between gradations is changing into the legible state. PROGRAMMABLE: The brightness of greyscale can be changed to your preference by downloading the application software from www.nec-display-solutions.com . CUSTOM: The gamma value is selected from the rate of 0.5 to 4.0 by 0.1 steps. When the COLOUR PRESET is sRGB, the value is fixed at 2.2 and NOT ADJUSTABLE.																				
	Gamma Offset	Adjusts the black level and is performed for both analog and digital signals. Black Level in Tag1 is effective only when the signal is analog. GAMMA OFFSET digitally adjusts the black level after the signal is converted from analog to digital.																				

Tag6	Colour Control	<p>Colour Control Systems: Six colour presets select the desired colour setting (sRGB, NATIVE and PROGRAMMABLE colour presets are standard and cannot be changed). Colour temperature increases or decreases, in each preset.</p> <p>R,Y,G,C,B,M,S: Increases or decreases Red, Yellow, Green, Cyan, Blue, Magenta and Saturation depending upon which is selected. The change in colour will appear on screen and the direction (increase or decrease) will be shown by the colour bars.</p> <p>NATIVE: Original colour presented by the LCD panel that is unadjustable.</p> <p>PROGRAMMABLE: The colour tone that was set up with the downloaded application software is reflected.</p>
Tag7	Sharpness	<p>This is a digital capability for keeping a crisp image at all signal timings. It continuously adjusts to maintain a distinct or soft image as you prefer, and is set independently according to different timings.</p> <p>The number of adjustment steps is different depending on whether the mode is OFF, FULL or ASPECT (1600 x 1200 is OFF Mode). Press “+” or “-” to adjust.</p>
	Expansion Mode	<p>Sets the zoom method.</p> <p>FULL: The image is expanded to 1600 x 1200, regardless of the resolution.</p> <p>ASPECT: The image is expanded without changing the aspect ratio.</p> <p>OFF: The image is not expanded.</p> <p>CUSTOM (Digital input and Resolution of 1600 x 1200 only): Select one of nine expansion rates. In this mode, the resolution may be low and there may be blank areas. This mode is for use with special video cards. Press “SELECT” to move the select menu, and press “+” or “-” to select.</p>
	Video Detect	<p>Selects the method of video detection when more than one computer is connected. Press “+” or “-” to select.</p> <p>FIRST DETECT: The video input has to be switched to “FIRST DETECT” mode. When current video input signal is not present, then the monitor searches for a video signal from the other video input port. If the video signal is present in the other port, then the monitor switches the video source input port to the new found video source automatically. The monitor will not look for other video signals while the current video source is present.</p> <p>LAST DETECT: The video input has to be switched to the “LAST DETECT” mode. When the monitor is displaying a signal from the current source and a new secondary source is supplied to the monitor, then the monitor will automatically switch to the new video source. When current video input signal is not present, then the monitor searches for a video signal from the other video input port. If the video signal is present in the other port, then the monitor switches the video source input port to the new found video source automatically.</p> <p>NONE: The Monitor will not search the other video input port unless the monitor is turned on.</p>
	DVI Selection	<p>This function selects the DVI input mode (Input 1). When the DVI selection has been changed, you must restart your computer. Press “+” or “-” to select.</p> <p>AUTO: By using the DVI-D to DVI-D cable, the DVI SECTION is DIGITAL. By using the D-SUB to DVI-A cable, the DVI SECTION is ANALOG.</p> <p>DIGITAL: DVI digital input is available.</p> <p>ANALOG: DVI analog input is available.</p>
	Off Timer	<p>Monitor will automatically power-down when the end user has selected a pre-determined amount of time.</p>
	Language	<p>OSM control menus are available in seven languages. Press “+” or “-” to select.</p>
	OSM Position	<p>You can choose where you would like the OSM control image to appear on your screen. Selecting OSM Location allows you to manually adjust the position of the OSM control menu left, right, down or up. Press “SELECT” to move the adjustment menu, and press “+” or “-” to adjust.</p>
	OSM Turn off	<p>The OSM control menu will stay on as long as it is in use. In the OSM Turn Off submenu, you can select how long the monitor waits after the last touch of a button to close the OSM control menu. The preset choices are 10-120 seconds by 5 seconds step. Press “+” or “-” to select.</p>

	OSM Lock Out	This control completely locks out access to all OSM control functions. When attempting to activate OSM controls while in the Lock Out mode, a screen will appear indicating the OSM controls are locked out. There are two types of OSM LOCK OUT: OSM LOCK OUT with BRIGHTNESS and CONTRAST control: To activate the OSM Lock Out function, press SELECT, then "+" key and hold down simultaneously. To deactivate the OSM Lock Out, press SELECT, then "+" key and hold down simultaneously. BRIGHTNESS and CONTRAST can be adjusted while in the lock out mode. OSM LOCK OUT with no control: To activate the OSM Lock Out function, press SELECT, then ">" key and hold down simultaneously. To deactivate the OSM Lock Out, press SELECT, then ">" key and hold down simultaneously. No controls can be adjusted while in the lock out mode.
	OSM Rotation	To switch OSM between Landscape and Portrait modes. Press "+" or "-" to select.
	Resolution Notifier	The optimal resolution is 1600 x 1200. If ON is selected, a message will appear on the screen after 30 seconds, notifying you that the resolution is not set to 1600 x 1200. Press "+" or "-" to select.
	Factory Preset	Selecting Factory Preset allows you to reset all OSM control settings (BRIGHTNESS, CONTRAST, IMAGE CONTROLS, COLOUR CONTROL SYSTEM, SHARPNESS, EXPANSION MODE, OFF TIMER, OSM LEFT/RIGHT, OSM DOWN/UP, OSM TURN OFF, DISPLAY MODE) back to the factory settings. Highlighting the control to be reset and pressing the RESET button can reset individual settings. Press "SELECT" to reset.
Tag8	Video Band Width (Analog input only)	It is used when the unnecessary noise from computer appears on a screen. It is strong ineffective, so that a number becomes small. Press "+" or "-" to select.
	Sync Threshold (Analog input only)	Adjusts the slice level of a synchronization signal. Press "SELECT" to move the adjustment menu. SEP/COMP.: Adjusts the sensitivity of the separate or composite input signals. Try this option if the FINE adjustment does not successfully eliminate the noise. Sync On Green: Adjusts the sensitivity of the Sync On Green input signals. Adjusts the slice level when separating a synchronization from Sync On Green signal input. Press "+" or "-" to select.
	SOG Correction (Analog input only)	Shapes the waveform of the Sync On Green signals. Try this option if the FINE adjustment does not eliminate the noise produced after the signal cable has been extended. Press "SELECT" to move adjustment menu. OFF The inputted synchronization signal is used as it is. AUTO Shapes the waveform according to the input waveform automatically. The signal which has not deteriorated is used as it is. ON Corrects the waveform irrespective of the input waveform.
	Edge Lock	Operating your monitor at a non-standard timing may cause images to appear darker than normal or have colour distortion. Use of the Edge Lock control will adjust images to their normal state.
Tag9	Display Mode	Provides information about the current display resolution and technical data, including the preset timing currently being used and the horizontal and vertical frequencies. Increases or decreases the current resolution. Press "SELECT" to move the adjustment mode, and press "+" or "-" to adjust.
	Monitor Info.	Indicates the model and serial numbers of your monitor.
	Demo Multi	Demo Multi demonstrates multiple screens. Press "SELECT" to move adjustment menu. This feature provides a single large screen using 4, 9, 16 and 25 monitors. This requires you to feed the PC output into each of the monitors through a splitter. Specify the number of monitors and determine the monitor numbers by referring to the figures in menu. Minimum screen size is 320 x 240. The number of monitors that you can use depends on the input resolution. I.e. if the resolution is VGA 640 x 480 and the screen size is selected by 320 x 240; the number of monitors will be 4 (2 hor./2 vert.). When using the resolution UXGA 1600 x 1200 and the screen size is (again) 320 x 240, the number of monitors will be 25 (5 hor./5 vert.).

Congratulations! You have just purchased a TCO'99 approved and labelled product! Your choice has provided you with a product developed for professional use. Your purchase has also contributed to reducing the burden on the environment and also to the further development of environmentally adapted electronics products.



Why do we have environmentally labelled computers?

In many countries, environmental labelling has become an established method for encouraging the adaptation of goods and services to the environment. The main problem, as far as computers and other electronics equipment are concerned, is that environmentally harmful substances are used both in the products and during the manufacturing. Since it has not been possible for the majority of electronics equipment to be recycled in a satisfactory way, most of these potentially damaging substances sooner or later enter Nature.

There are also other characteristics of a computer, such as energy consumption levels, that are important from the viewpoints of both the work (Internal) and natural (external) environments. Since all methods of conventional electricity generation have a negative effect on the environment (acidic and climate-influencing emissions, radioactive waste, etc.), it is vital to conserve energy. Electronics equipment in offices consume an enormous amount of energy since they are often left running continuously.

What does labelling involve?

This product meets the requirements for the TCO'99 scheme which provides for international and environmental labelling of personal computers. The labelling scheme was developed as a joint effort by the TCO (The Swedish Confederation of Professional Employees), Svenska Naturskyddsforeningen (The Swedish Society for Nature Conservation) and Statens Energimyndighet (The Swedish National Energy Administration).

The requirements cover a wide range of issues: environment, ergonomics, usability, emission of electrical and magnetic fields, energy consumption and electrical and fire safety.

The environmental demands concern restrictions on the presence and use of heavy metals, brominated and chlorinated flame retardants, CFCs (freons) and chlorinated solvents, among other things. The product must be prepared for recycling and the manufacturer is obliged to have an environmental plan which must be adhered to in each country where the company implements its operational policy. The energy requirements include a demand that the computer and/or display, after a certain period of inactivity, shall reduce its power consumption to a lower level in one or more stages. The length of time to reactivate the computer shall be reasonable for the user.

Labelled products must meet strict environmental demands, for example, in respect of the reduction of electric and magnetic fields, physical and visual ergonomics and good usability.

Environmental Requirements

Flame retardants

Flame retardants are present in printed circuit boards, cables, wires, casings and housings. In turn, they delay the spread of fire. Up to thirty percent of the plastic in a computer casing can consist of flame retardant substances. Most flame retardants contain bromine or chloride and these are related to another group of environmental toxins, PCBs, which are suspected to give rise to severe health effects, including reproductive damage in fish-eating birds and mammals, due to the bioaccumulative* processes. Flame retardants have been found in human blood and researchers fear that disturbances in foetus development may occur.

TCO'99 demand requires that plastic components weighing more than 25 grams must not contain flame retardants with organically bound chlorine and bromine. Flame retardants are allowed in the printed circuit boards since no substitutes are available.

Lead**

Lead can be found in picture tubes, display screens, solders and capacitors. Lead damages the nervous system and in higher doses, causes lead poisoning.

TCO'99 requirement permits the inclusion of lead since no replacement has yet been developed.

Cadmium**

Cadmium is present in rechargeable batteries and in the colourgenerating layers of certain computer displays. Cadmium damages the nervous system and is toxic in high doses.

TCO'99 requirement states that batteries, the colourgenerating layers of display screens and the electrical or electronics components must not contain any cadmium.

Mercury**

Mercury is sometimes found in batteries, relays and switches. Mercury damages the nervous system and is toxic in high doses. TCO'99 requirement states that batteries may not contain any Mercury. It also demands that no mercury is present in any of the electrical or electronics components associated with the display unit.

CFCs (freons)

CFCs (freons) are sometimes used for washing printed circuit boards. CFCs break down ozone and thereby damage the ozone layer in the stratosphere, causing increased reception on Earth of ultraviolet light with consequent increased risks of skin cancer (malignant melanoma).

The relevant TCO'99 requirement; Neither CFCs nor HCFCs may be used during the manufacturing and assembly of the product or its packaging.

*Bio-accumulative is defined as substances which accumulate within living organisms.

**Lead, Cadmium and Mercury are heavy metals which are Bio-accumulative.

To obtain complete information on the environmental criteria document, order from:

TCO Development Unit
SE-114 94 Stockholm
SWEDEN
FAX Number: +46 8 782 92 07
E-mail (Internet): development@tco.se

You may also obtain current information on TCO'99 approved and labelled products by visiting their website at:
<http://www.tcodevelopment.com>

TCO Development



Congratulations!

The display you have just purchased carries the TCO'03 Displays label. This means that your display is designed, manufactured and tested according to some of the strictest quality and environmental requirements in the world. This makes for a high performance product, designed with the user in focus that also minimizes the impact on our natural environment.

Some of the features of the TCO'03 Display requirements:

Ergonomics

- Good visual ergonomics and image quality in order to improve the working environment for the user and to reduce sight and strain problems. Important parameters are luminance, contrast, resolution, reflectance, colour rendition and image stability.

Energy

- Energy-saving mode after a certain time – beneficial both for the user and the environment
- Electrical safety

Emissions

- Electromagnetic fields
- Noise emissions

Ecology

- The product must be prepared for recycling and the manufacturer must have a certified environmental management system such as EMAS or ISO 14 001
- Restrictions on:
 - chlorinated and brominated flame retardants and polymers
 - heavy metals such as cadmium, mercury and lead.

The requirements included in this label have been developed by TCO Development in co-operation with scientists, experts, users as well as manufacturers all over the world. Since the end of the 1980s TCO has been involved in influencing the development of IT equipment in a more user-friendly direction. Our labelling system started with displays in 1992 and is now requested by users and IT-manufacturers all over the world.

For more information, please visit
www.tcodevelopment.com

English-20

Manufacturer's Recycling and Energy Information

NEC DISPLAY SOLUTIONS is strongly committed to environmental protection and sees recycling as one of the company's top priorities in trying to minimize the burden placed on the environment. We are engaged in developing environmentally-friendly products, and always strive to help define and comply with the latest independent standards from agencies such as ISO (International Organisation for Standardization) and TCO (Swedish Trades Union).

For more information, and for help in recycling your old NEC monitors, please visit our website at

<http://www.nec-display-solutions.com> (in Europe) or

<http://www.nec-display.com> (in Japan) or

<http://www.necdisplay.com> (in USA).

Country-specific recycling programmes can also be found at:

Sweden - <http://www.el-retur.se>

Germany - <http://www.recyclingpartner.de/>

Holland - <http://www.mirec.nl/>

Japan - <http://www.diarcs.com/>

Energy saving:

This monitor features an advanced energy saving capability. When a VESA Display Power Management Signaling (DPMS) Standard signal is sent to the monitor, the Energy Saving mode is activated. The monitor enters a single Energy Saving mode.

Mode	Power consumption	LED colour
Normal Operation	Approx. 52W	Green
Energy Saving Mode	Less than 1W	Amber
Off Mode	Less than 0.1W	Unlit

Disposing of your old NEC product

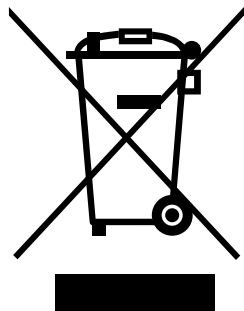

Within the European Union

EU-wide legislation, as implemented in each Member State, requires that waste electrical and electronic products carrying the mark (left) must be disposed of separately from normal household waste. This includes monitors and electrical accessories, such as signal cables or power cords. When you need to dispose of your NEC display products, please follow the guidance of your local authority, or ask the shop where you purchased the product, or if applicable, follow any agreements made between yourself and NEC.

The mark on electrical and electronic products only applies to the current European Union Member States.

Outside the European Union

If you wish to dispose of used electrical and electronic products outside the European Union, please contact your local authority so as to comply with the correct disposal method.

Free Manuals Download Website

<http://myh66.com>

<http://usermanuals.us>

<http://www.somanuals.com>

<http://www.4manuals.cc>

<http://www.manual-lib.com>

<http://www.404manual.com>

<http://www.luxmanual.com>

<http://aubethermostatmanual.com>

Golf course search by state

<http://golfingnear.com>

Email search by domain

<http://emailbydomain.com>

Auto manuals search

<http://auto.somanuals.com>

TV manuals search

<http://tv.somanuals.com>