

4/ 8/ 16 Port 1U Rack Mount USB VGA KVM Switch with OSD

SV431DUSB

SV831DUSB / SV831DUSBGB

SV1631DUSB / SV1631DUSBGB



*actual product may vary from photos

DE: Bedienungsanleitung - de.startech.com

FR: Guide de l'utilisateur - fr.startech.com

ES: Guía del usuario - es.startech.com

IT: Guida per l'uso - it.startech.com

NL: Gebruiksaanwijzing - nl.startech.com

PT: Guia do usuário - pt.startech.com

For the most up-to-date information, please visit: www.startech.com

Manual Revision: 10/03/2012

Download from Www.Somanuals.com. All Manuals Search And Download.

FCC Compliance Statement

This equipment has been tested and found to comply with the limits for a Class B digital device, pursuant to part 15 of the FCC Rules. These limits are designed to provide reasonable protection against harmful interference in a residential installation. This equipment generates, uses and can radiate radio frequency energy and, if not installed and used in accordance with the instructions, may cause harmful interference to radio communications. However, there is no guarantee that interference will not occur in a particular installation. If this equipment does cause harmful interference to radio or television reception, which can be determined by turning the equipment off and on, the user is encouraged to try to correct the interference by one or more of the following measures:

- Reorient or relocate the receiving antenna.
- Increase the separation between the equipment and receiver.
- Connect the equipment into an outlet on a circuit different from that to which the receiver is connected.
- Consult the dealer or an experienced radio/TV technician for help.

Use of Trademarks, Registered Trademarks, and other Protected Names and Symbols

This manual may make reference to trademarks, registered trademarks, and other protected names and/or symbols of third-party companies not related in any way to StarTech.com. Where they occur these references are for illustrative purposes only and do not represent an endorsement of a product or service by StarTech.com, or an endorsement of the product(s) to which this manual applies by the third-party company in question. Regardless of any direct acknowledgement elsewhere in the body of this document, StarTech.com hereby acknowledges that all trademarks, registered trademarks, service marks, and other protected names and/or symbols contained in this manual and related documents are the property of their respective holders.

Table of Contents

Introduction	1
Packaging Contents	1
System Requirements.....	1
Installation	2
Console Installation.....	2
Computer Installation.....	3
Cascaded configurations.....	4
Operation	6
Push Button controls	6
OSD (On Screen Display) Operation.....	7
Hot-key Commands	11
Specifications.....	14
Technical Support	15
Warranty Information.....	15

Introduction

Thank you for purchasing a StarTech.com Professional USB Console KVM Switch. This product offers a reliable and efficient way to manage multiple computers in server rooms, or any other environment where space is at a premium. The switch features an on-screen display that allows comprehensive monitoring of computer naming and selection as well as status indication.

Packaging Contents

- 1 x Professional KVM Switch
- 1 x PS/2 keyboard and mouse Y Cable
- 2 x Rack Mount Brackets
- 1 x Power Adapter
- 1 X Instruction Manual

System Requirements

- VGA and USB and/or PS/2 enable computer systems
- VGA enabled display device
- StarTech.com 3-in-1 "SVECON" (PS/2) or 2-in-1 "SVECONUS" (USB) KVM Cables
- Standard 104-key wired USB or PS/2 keyboard
- Standard 3-button wired USB or PS/2 keyboard

NOTE: SV431DUSB can only use a USB keyboard and mouse

Installation

NOTE: Prior to the installation, please power off all devices that will be connected to this system.

Ensure that all devices you will connect are properly grounded.

Place cables away from fluorescent lights, air conditioners, and machines that are likely to generate electrical noise.

Console Installation

The SV831DUSB and SV1631DUSB are designed to use both USB and PS/2 console connections, and are equipped with a slide switch console selector for the selection of USB or PS/2 modes. There are three connection patterns that correspond with the slide switch as follows:

PS/2 Keyboard and PS/2 Mouse: A PS/2 "Y" cable (provided) is required for this mode.

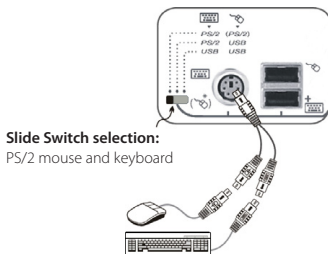

Slide Switch selection:
PS/2 mouse and keyboard

PS/2 Keyboard and USB Mouse: Slide switch to the center position

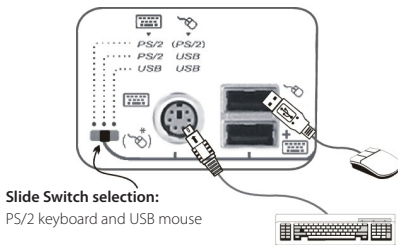

Slide Switch selection:
PS/2 keyboard and USB mouse

USB Keyboard and USB Mouse: Slide switch to the far right position.

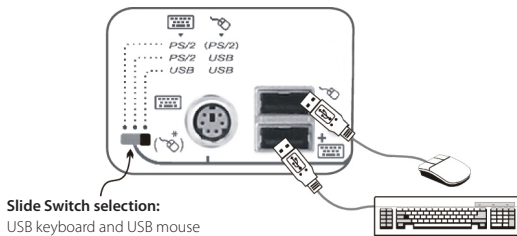

NOTE: When configuring the switch as a Slave in a cascaded configuration, PS/2 Keyboard and Mouse is the only mode that can be used. Therefore, SV431DUSB cannot be configured as a slave in a cascaded setup, as it does not provide a slide switch selector.

Computer Installation

USB Computer

To connect a computer controlled through USB, use a StarTech.com 2-in-1 Ultra-Thin USB KVM cable (Product ID: **SVECONUS**) to connect from one of the PC Ports located on the rear panel of the KVM switch to the USB and VGA ports on the computer system.

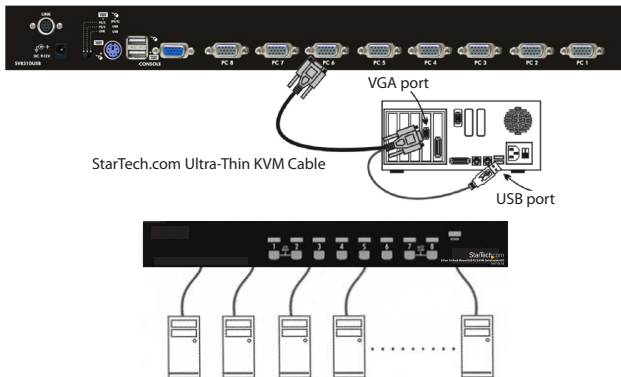

PS/2 Computer

To connect a computer controlled through PS/2, use a StarTech.com 3-in-1 Ultra-Thin PS/2 KVM cable (Product ID: **SVECON**) to connect from one of the PC ports to the PS/2 keyboard and mouse, as well as the VGA port of the computer system.

Cascaded configurations

NOTE: The master must have equal or more PC ports than that of the slave. For example, if an 8-port switch is the Master, an 8-port or 4-port switch can be a Slave, but not a 16-port switch.

NOTE: PS/2-only models can be cascaded with USB+PS/2 universal models.

NOTE: To be used as Slaves in a cascaded configuration, the slide switch on SV831DUSB or SV1631DUSB must be adjusted to PS/2 mode.

The ports labelled PC 1 - PC 8 can be connected to either a computer or a Slave's CONSOLE port. The ports marked PC A - PC H can only be connected to computers. Use only the 3-in-1 (PS/2) cables to connect the Master's PC ports and Slave's CONSOLE port.

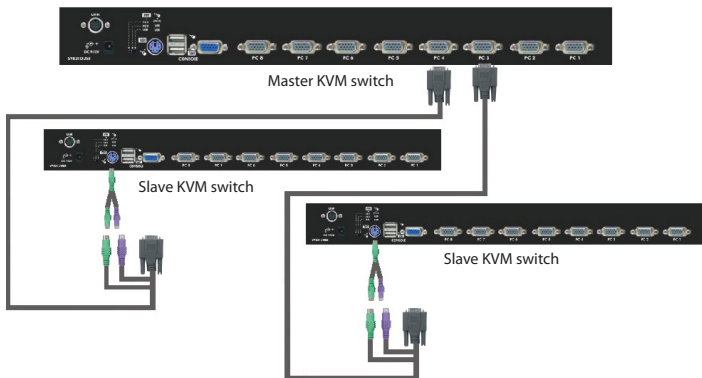

The maximum number of computers controlled by a Master/Slave configuration with all 8-port units is 64, with 8 Slaves and each Slave connecting to 8 computers:

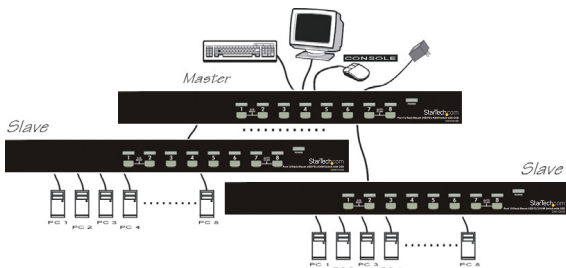

The maximum number of computers controlled in a Master/Slave configuration with all 16-port units is 136, with 8 units of 16-port Slaves (to PC 1 - PC 8) and each Slave connected to 16 computers, plus 8 more computers connected directly to the Master (to ports PC A - PC H):

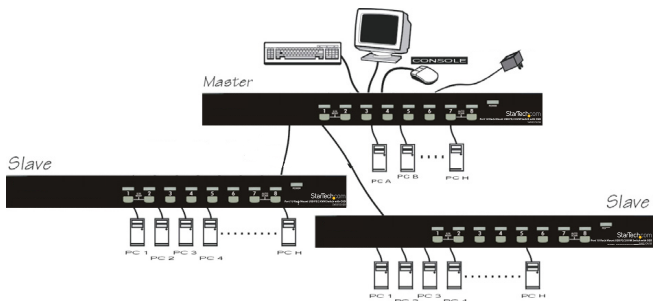

After the connection has been completed, please re-activate the OSD menu to verify that the Master recognizes the Slaves. A triangle mark (▶) is placed next to the right of the channel name indicating that the port is connected to a Slave, not a computer. A number to the left of the triangle mark indicates the Slave model, i.e. '8' for an 8-port switch.

NOTE: A device (computer or KVM switch) at any 'PC x' port can be changed at any time after initial power-up. If you change any one of the PC 1 to PC 8 port connections from a computer to a Slave KVM switch or vice versa, or replace the devices of a port, the OSD will update this change the next time it is activated.

Operation

You may select a computer by pressing the front panel push button directly, by issuing hot-key commands or by activating the OSD window. The front panel indicator changes to reflect the computer port selected (red) and whether the port is connected to a powered computer (green). The indicator flashes red when it is in either Auto Scan or Manual Scan mode.

Push Button controls

To select control of an attached computer, press the front panel button that corresponds with the assigned computer number. For 16 port models, 1 to 8 represents the lower 8 ports, while A to H indicates the higher ports. Ports 1 and A share the same push button, as do 2 and B, 3 and C etc.

Example: If port 1 is already selected and you wish to switch to Port A, tap the shared push button once to select Port A. If Port 1 is not selected, press and hold push button 1 for two seconds to select Port A.

K/M Reset

K/M Reset resolves the majority of problems developed by keyboard and/or mouse device replacement or configuration changes. Press down buttons 1 and 2 simultaneously for 2 seconds to reconfigure the whole system without having to turn off the KVM switch or any attached computers.

Auto Scan

This KVM switch provides an easy to use feature to start Auto Scanning. To use this function, simultaneously press buttons 7 and 8 and hold for two seconds. (SV431DUSB uses buttons 3 and 4 to launch this function).

OSD (On Screen Display) Operation

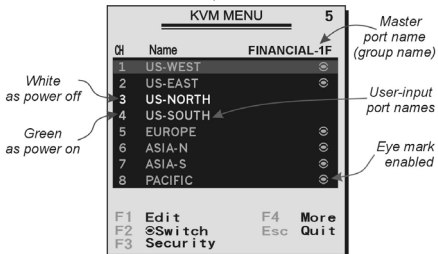
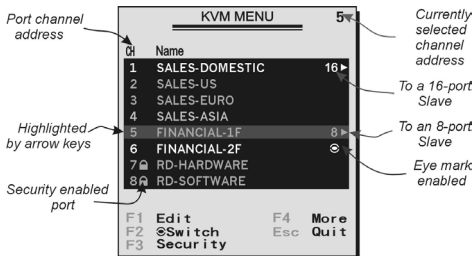

By hitting the left **<CTRL>** key twice within two seconds, you may see the 'Hotkey Menu' if it is enabled (an OSD option). Or, by hitting the left **<CTRL>** key three times within two seconds, you will see a 'KVM MENU' screen showing a list of the computers with corresponding channel addresses, names and status.

The channel address (port number) of the currently selected computer is displayed in red, same as the front indicator, to the right of the OSD title 'KVM MENU'.

The color of a device name is green if it has power and is ready for selection (its corresponding front panel indicator is green). The color is white if it has no power. The OSD menu updates when it is activated.

Use the **<UP>** and **<DOWN>** arrow keys to highlight a computer and the **<ENTER>** key to select it. Or, you may press **<ESCAPE>** to exit OSD and remove the OSD menu from the display; the status window returns to the display and indicates the currently selected computer or operating status.

A triangle mark (▶) to the right of a name indicates the port is cascaded to a Slave; the number at the left of the triangle mark shows the number of ports the Slave has (i.e. 8 for SV831DUSB). The <ENTER> key brings you one level down and another screen pops up listing the names of the computers on that Slave. The name of the Slave will be shown at the upper right corner of the OSD menu. It is useful to group computers and still be able to see the group name.

An eye mark (👁) to the right of a name indicates the computer is selected to be monitored in Scan mode. In OSD, this mark can be switched on or off by function key <F2>.

Press the <ESCAPE> key to exit the OSD and to return to the selected computer, The computer name is also shown on the screen.

Function key <F1>:

To edit the name entry of a computer or a Slave. First, use the <UP> and <DOWN> arrow keys to highlight a channel then press <F1> followed by name entry. Valid characters are 'A'~'Z', '0'~'9' and the dash character. Lowercase letters are converted to uppercase ones. Press the <BACKSPACE> key to delete a letter one at a time. Non-volatile memory stores all name entries until you change, even if the unit is powered down.

Function key <F2>:

To switch the eye mark (👁) of a computer on or off. First, use the <UP> and <DOWN> arrow keys to highlight it, then press <F2> to switch its eye mark on or off. If Scan Type is 'Ready PC + 👁', only the power-on and eye mark selected computers will be displayed sequentially in Scan mode.

Function key <F3>:

To lock a device (a computer or a Slave) from unauthorized access, use Security. Security is effective for only one device (a computer or a Slave). To lock a device, use the <UP> and <DOWN> arrow keys to highlight it, then press <F3>. Now, enter up to 4 characters ('A'~'Z', '0'~'9', '-') followed by <ENTER> as new password. A Security enabled device is marked with a lock (🔒) following its channel number. To permanently disable the security function from a locked device, highlight it, press <F3> then enter the password.

If you want to access the locked device temporarily, simply highlight it and press <ENTER>, the OSD will ask you for the password. After entering the correct password, you are allowed to use the device. This device is automatically re-locked once you switch to another port. During Scan mode, OSD skips the security-enabled device.

NOTE: If you forget the password, the only way to permanently erase all of the passwords is to: For SV831DUSB and SV1631DUSB, press and hold the 1 and 2 front panel buttons, then hold 7 and 8. Release 7 and 8, then release 1 and 2. For SV431DUSB, press 3 and 4 instead of 7 and 8.

Function key <F4>:

More functions are available by hitting <F4>. A new screen pops up displaying more functions as described below. Most of them are marked with a triangle (▶) indicating there are options to choose from. Using the <UP> and <DOWN> arrow keys, select the functions and press <ENTER>. Available options will be shown in the middle of the screen. Again, using the <UP> and <DOWN> arrow keys to view options then press <ENTER> to select it. You can press <ESCAPE> to exit at any time.

Auto Scan:



In this mode, the KVM Switch automatically switches from one power-on computer to the next, sequentially, in a fixed interval. During AutoScan mode, the OSD displays the name of the selected computer.

When Auto Scan detects any keyboard or mouse activity, it suspends the scanning till activity stops; it then resumes with the next computer in sequence. To abort Auto Scan mode, press the left <CTRL> twice, or, press any front button. Scan Type and Scan Rate set the scan pattern. Scan Type (<F4>: More\Scan Type) determines if scanned computers must also be eye mark selected. Scan Rate(<F4>: More\Scan Rate) sets the display interval when a computer is selected before selecting the next one.

Manual Scan:

Scan through power-on computers one by one by keyboard control. You can type (<F4>: More\Scan Type) to determine if scanned computers must also be eye mark selected. Press the <UP> arrow key to select the previous computer and the <DOWN> arrow key to select the next computer. Press any other key to abort Manual Scan mode.

Scan Type:

- **Ready PC + **: In Scan mode, scans through power-on computers and those with the eye mark on the selected ports.
- **Ready PC:** In Scan mode, scans through all power-on computers.
- ** only:** In Scan mode, scans through any  marked computer regardless of computer power status. Non-volatile memory stores the Scan Type settings.

Scan Rate:

Sets the duration of a computer displayed in Auto Scan mode. The options are 3 seconds, 8 seconds, 15 seconds and 30 seconds. The non-volatile memory stores the Scan Rate setting.

Keyboard Speed:

The KVM offers PS/2 Keyboard typematic setting that overrides the similar settings in BIOS and in Windows. Available speed options are Low, Middle, Fast and Faster as 10, 15, 20 and 30 characters/sec respectively. Keyboard settings are stored in non-volatile memory.

Hotkey Menu:

When you hit the left <CTRL> key twice within two seconds, the Hotkey Menu appears displaying a list of hot-key commands if this option is On.

The Hotkey Menu can be turned Off if you prefer not to see it when the left <CTRL> key is hit twice. The non-volatile memory stores the Hotkey Menu setting.

CH Display:

- **Auto Off:** After you select a computer, the channel address and name of the computer will appear on the screen for 3 seconds then disappear automatically.
- **Always On:** The channel address and name of a selected computer and/or OSD status displayed on the screen all the time. The non-volatile memory stores the CH Display setting.
- **Position:** The position of the selected computer name and/or OSD status displayed on screen during operation. The actual display position shifts due to different VGA resolution, the higher the resolution the higher the display position. The nonvolatile memory stores the Position setting.

Upper Left, Upper Right,

Middle.

Lower Left, Lower Right.

Country Code for Sun:

Sun keyboards of different languages have different layouts. The KVM switch is able to emulate a Sun keyboard for a specific language type or country such as Arabic, Belgian, US, Yugoslavia, etc. Select the proper country code that matches all of your Sun computers.

NOTE: The country code must be set prior to powering up the Sun computer. Not performing this step prior to power-up could cause the system to malfunction.

Max. Resolution:

The KVM supports widescreen, and you can adjust the monitor resolution under this sub-menu. The following selections are available: 1024 x 768, 1280 x 1024, 1600 x 1200, 1920 x 1440 and "DDC2B Disable".

Function Key <F5>:

To switch the Sun mark of a port on or off indicating the computer is a Sun server. Sun servers have more keys on the keyboard than a PC. When a Sun-marked port is selected, the KVM Switch starts to translate the keys from a PC keyboard to a Sun keyboard. See the section entitled Sun Keyboard Mapping for further detail.

NOTE: It is unnecessary to switch the Sun mark ON or OFF if an authentic Sun keyboard is being used on the console. In other words, you must ensure that the Sun-marked port has not been selected if you are already using a Sun keyboard.

With different types of keyboard and computer, the Sun Mark must be set up in compliance with the following instruction:

Keyboard Type	Computer Type	Sun Mark
USB (non-Sun)	PC/Mac	No
USB (non-Sun)	Sun	Yes
USB (Sun keyboard)	PC/Mac	No
USB (Sun keyboard)	Sun	Yes

ESC: To exit the OSD, press the <ESCAPE> key

Hot-key Commands

Hot-key command is a short keyboard sequence used to select a computer, to activate computer scan, etc. The KVM interprets keystrokes followed by one or two more keystrokes. A built-in buzzer generates a high-pitch beep for a correct hotkey command, otherwise, one low-pitch beep for an error and the bad key sequence will not be forwarded to the selected computer.

The short form hotkey menu can be turned on as an OSD function (<F4>:More\Hotkey Menu) every time the left <CTRL> is pressed twice.

NOTE: Left <CTRL>: refers to the Control key on the left side of the keyboard.

1~8/A~H: refers to the number keys '1'~'8' in the upper row of the keyboard and character keys 'A'~'H'. Do not use the keypad at the right of the keyboard.

To select a computer by hotkey command, you must know its port number, which is determined by the KVM Switch connection. For a computer connected to a Slave, two characters represent its port. The first character is the port number of the Master unit (1~8) and the second one is the port number of the Slave (1~8 or A~H). Please note that only the Master's 'PC1'~'PC8' ports can be connected to a Slave.

EXAMPLES:

Left <CTRL> , Left <CTRL> , <7> : Selects a computer connected to port 7 of the Master.

Left <CTRL> , Left <CTRL> , <6> , <C> : Selects a computer connected to port C of a Slave connected to port 6 of the Master.

Auto Scan

In this mode, the KVM Switch automatically switches from one power-on computer to the next, sequentially, in a fixed interval. During AutoScan mode, the OSD displays the name of the selected computer.

Left <CTRL> , Left <CTRL> , <F1>

When Auto Scan detects any keyboard or mouse activity, it suspends the scanning until the activity stops. It then resumes with the next computer in sequence. The length of the Auto Scan interval (Scan Rate) is adjustable. To abort Auto Scan mode, press the left <CTRL> key twice.

NOTE: Scan Type determines whether an eye-marked computer is to be displayed during Auto Scan.

Manual Scan

This mode enables you to manually switch back and forth between the powered computers:

Left <CTRL>, Left <CTRL>, <F2>

Press the <UP> arrow key to select the previous computer and the <DOWN> arrow key to select the next computer. Press any other key to abort Manual Scan mode.

NOTE: Scan Type determines whether an eye-marked computer is to be displayed during Auto Scan.

Scan Rate

To adjust Scan Rate, which sets the duration before switching to the next computer in Auto Scan:

Left <CTRL>, Left <CTRL>, <F3>

The switch will beep one to four times indicating the scan interval of 3, 8, 15 and 30 seconds respectively.

To adjust keyboard typematic rate (characters/sec) for PS/2 keyboards:

Left <CTRL>, Left <CTRL>, <F4>

The KVM switch beeps 1 to 4 times corresponding to 10, 15, 20 and 30 characters/sec respectively.

Sun/Mac Keyboard Mapping





The KVM Switch emulates a Sun Keyboard when a computer is marked with a Sun, in the OSD menu by Function Key <F5>. A Sun keyboard has more keys than a standard PC keyboard. These extra keys are simulated by tapping the Right <CTRL> button, which is normally located on the right lower part of the keyboard, followed by one of the function keys on the general keyboard (i.e. combo key). For example, tap the Right <CTRL> key, and then tap the function key <F7> to activate Open for a Sun computer.

NOTE: For older Sun Operating Systems, the switch does not support the Low Power option under Power Off Select.

For keystroke emulation of Sun/Mac computers, please refer to the above chart and conduct the following two examples:

“Stop A” function in Sun: Press right <CTRL> and release, then within two seconds press <F1> and <A> in sequence.

“Help” function in Sun: Press right <CTRL> and release, then within 2 seconds, press <H>.

Standard Keyboard	Map to Sun keyboard	Map to Mac keyboard
right <CTRL>, <1>		-
right <CTRL>, <2>		-
right <CTRL>, <3>		-
right <CTRL>, <4>		Power
right <CTRL>, <F1>	Stop	-
right <CTRL>, <F2>	Again	-
right <CTRL>, <F3>	Props	-
right <CTRL>, <F4>	Undo	-
right <CTRL>, <F5>	Front	-
right <CTRL>, <F6>	Copy	-
right <CTRL>, <F7>	Open	-
right <CTRL>, <F8>	Paste	-
right <CTRL>, <F9>	Find	-
right <CTRL>, <F10>	Cut	-
Print Screen	-	<F13>
Scroll Lock	-	<F14>
Pause Break	-	<F15>
right <CTRL>, <H>	Help	-
right <Windows> key	right <- >	right <COMMAND>
left <Windows> key	left <- >	left <COMMAND>
<Menu> key	Compose	-
right <ALT>	Alt Graph	right <OPTION>
left <ALT>	<ALT>	left <OPTION>

Specifications

	SV431DUSB	SV831DUSB	SV1631DUSB
Number of Ports	4	8	16
Console Connectors	2 x USB type A female 1 x DE-15 VGA female	2 x USB type A female 1 x PS/2 female 1 x DE-15 VGA female	2 x USB type A female 1 x PS/2 female 1 x DE-15 VGA female
Computer Connectors (per port)		1 x DE-15 Female	
LEDs	1 x Power 4 x Port Selection/Power	1 x Power 8 x Port Selection/Power	1 x Power 16 x Port Selection/Power
Supported Computer Interfaces		PS/2, USB	
Maximum Video Resolution		1920 x 1440	
Switching Methods		Front Panel buttons, Hot-key, OSD	
Rack Mountable		Yes*	
Cascadable		Yes	
Power Adapter		9~12V DC, 600mA	
Operating Temp.		5°C ~ 40°C (41°F ~ 104°F)	
Storage Temp.		-20°C ~ 60°C (-4°F ~ 140°F)	
Humidity		0% ~ 80% RH	
Dimensions	220mm x 130mm x 45mm	438mm x 180mm x 45mm	438mm x 180mm x 45mm
Weight	1500g	2900g	3100g

*SV431DUSB rack mount kit sold separately (Product ID: SV431RACK)

Technical Support

StarTech.com's lifetime technical support is an integral part of our commitment to provide industry-leading solutions. If you ever need help with your product, visit www.startech.com/support and access our comprehensive selection of online tools, documentation, and downloads.

For the latest drivers/software, please visit www.startech.com/downloads

Warranty Information

This product is backed by a three year warranty.

In addition, StarTech.com warrants its products against defects in materials and workmanship for the periods noted, following the initial date of purchase. During this period, the products may be returned for repair, or replacement with equivalent products at our discretion. The warranty covers parts and labor costs only. StarTech.com does not warrant its products from defects or damages arising from misuse, abuse, alteration, or normal wear and tear.

Limitation of Liability

In no event shall the liability of StarTech.com Ltd. and StarTech.com USA LLP (or their officers, directors, employees or agents) for any damages (whether direct or indirect, special, punitive, incidental, consequential, or otherwise), loss of profits, loss of business, or any pecuniary loss, arising out of or related to the use of the product exceed the actual price paid for the product. Some states do not allow the exclusion or limitation of incidental or consequential damages. If such laws apply, the limitations or exclusions contained in this statement may not apply to you.

Hard-to-find made easy. At StarTech.com, that isn't a slogan. It's a promise.

StarTech.com is your one-stop source for every connectivity part you need. From the latest technology to legacy products — and all the parts that bridge the old and new — we can help you find the parts that connect your solutions.

We make it easy to locate the parts, and we quickly deliver them wherever they need to go. Just talk to one of our tech advisors or visit our website. You'll be connected to the products you need in no time.

Visit www.startech.com for complete information on all StarTech.com products and to access exclusive resources and time-saving tools.

StarTech.com is an ISO 9001 Registered manufacturer of connectivity and technology parts. StarTech.com was founded in 1985 and has operations in the United States, Canada, the United Kingdom and Taiwan servicing a worldwide market.

Free Manuals Download Website

<http://myh66.com>

<http://usermanuals.us>

<http://www.somanuals.com>

<http://www.4manuals.cc>

<http://www.manual-lib.com>

<http://www.404manual.com>

<http://www.luxmanual.com>

<http://aubethermostatmanual.com>

Golf course search by state

<http://golfingnear.com>

Email search by domain

<http://emailbydomain.com>

Auto manuals search

<http://auto.somanuals.com>

TV manuals search

<http://tv.somanuals.com>