



## Cooling Tower Water and Chilled Water Pump Tanks

Part Number: A0552321  
Bulletin Number: SC5-605.7  
Effective: 4/11/08

Write Down Your Serial Numbers Here For Future Reference:

_____	_____
_____	_____
_____	_____

We are committed to a continuing program of product improvement. Specifications, appearance, and dimensions described in this manual are subject to change without notice.

DCN No. \_\_\_\_\_  
© Copyright 2008  
All rights reserved.

# Shipping Information

---

## ***Unpacking and Inspection***

You should inspect your equipment for possible shipping damage. Thoroughly check the equipment for any damage that might have occurred in transit, such as broken or loose wiring and components, loose hardware and mounting screws, etc.

## ***In the Event of Shipping Damage***

According to the contract terms and conditions of the Carrier, the responsibility of the Shipper ends at the time and place of shipment.

Notify the transportation company's local agent if you discover damage

Hold the damaged goods and packing material for the examining agent's inspection. **Do not return any goods before the transportation company's inspection and authorization.**

File a claim with the transportation company. Substantiate the claim by referring to the agent's report. A certified copy of our invoice is available upon request. The original Bill of Lading is attached to our original invoice. If the shipment was prepaid, write us for a receipted transportation bill.

Advise customer service regarding your wish for assistance and to obtain an RMA (return material authorization) number.

## ***If the Shipment is Not Complete***

Check the packing list as back-ordered items are noted on the packing list. In addition to the equipment itself, you should have:

- Bill of lading
- Packing list
- Operating and Installation packet
- Electrical schematic and panel layout drawings
- Component instruction manuals (if applicable)

Re-inspect the container and packing material to see if you missed any smaller items during unpacking.

## ***If the Shipment is Not Correct***

If the shipment is not what you ordered, **contact the parts and service department immediately** at (262) 641-8610. Have the order number and item number available. *Hold the items until you receive shipping instructions.*

## ***Returns***

Do not return any damaged or incorrect items until you receive shipping instructions from the shipping department.

# Table of Contents

---

<b>CHAPTER 1: SAFETY .....</b>	<b>5</b>
1-1 How to Use This Manual .....	5
<i>Safety Symbols Used in this Manual.....</i>	<i>5</i>
1-2 Warnings and Precautions .....	6
1-3 Responsibility .....	6
<b>CHAPTER 2: FUNCTIONAL DESCRIPTION.....</b>	<b>7</b>
2-1 Models Covered in This Manual.....	7
2-2 General Description .....	7
2-3 Standard Features .....	8
2-4 Optional Features.....	9
<b>CHAPTER 3: INSTALLATION .....</b>	<b>10</b>
3-1 Uncrating Your Pump Tank.....	10
3-2 Installation Location Considerations.....	10
3-3 Rigging.....	10
3-4 Installing Separate Tank Ledge Models .....	11
3-5 Installing Optional Equipment.....	11
3-6 Making Electrical Connections .....	11
3-7 Making Piping Connections.....	12
<i>Tower Tank Piping Connections .....</i>	<i>14</i>
<i>Chilled Water Piping Connections.....</i>	<i>15</i>
3-8 Initial Start-up .....	15
<b>CHAPTER 4: OPERATION .....</b>	<b>16</b>
4-1 Start-up .....	16
4-2 Determining Flow Rate.....	16
4-3 Stand-by Pump Usage .....	17
<i>Single Stand-by pump:.....</i>	<i>17</i>
<i>Dual Stand-By Pump.....</i>	<i>17</i>
4-4 Shut-down .....	17
<b>CHAPTER 5: MAINTENANCE .....</b>	<b>18</b>
5-1 Preventative Maintenance.....	18
<i>Water Treatment .....</i>	<i>18</i>
<i>Lubricating Pump Motors and Seals.....</i>	<i>18</i>
<i>Maintaining Makeup Valve Assemblies.....</i>	<i>18</i>
<b>CHAPTER 6: APPENDIX .....</b>	<b>19</b>
6-1 Technical Assistance .....	19
<i>Parts Department .....</i>	<i>19</i>
<i>Service Department.....</i>	<i>19</i>
6-2 Remote Starters and NEMA Panels.....	20

	<i>NEMA Panel Standard Features</i> .....	20
	<i>NEMA Panel Options</i> .....	20
6-3	Drawings and Specifications .....	21
	<i>Cooling Tower Water Pump Tanks</i> .....	21
	<i>Chilled Water Pump Tanks</i> .....	23
	<i>Process Pump Curves and Specifications</i> .....	25
	<i>Re-circulation Pump Curves and Specifications</i> .....	26
6-4	Parts List .....	27
	<i>Recommended Spare Parts</i> .....	27
	<i>Spare Process Pump Seals and Casing Gaskets</i> .....	27
	<i>Spare Re-circulating Pump Seals and Casing Gaskets</i> .....	27
6-5	Optional Assembly Detail Drawings .....	28
	<i>Tank Support Leg Assembly Detail: 4 Legs</i> .....	28
	<i>Tank Support Leg Assembly Detail: 6 Legs</i> .....	29
	<i>Tank Support Leg Assembly Detail: 7 Legs</i> .....	30
	<i>Tank Ladder Assembly Detail</i> .....	31
	<i>Sightglass Assembly Detail</i> .....	32
6-6	Typical Piping Diagrams.....	33
	<i>Typical Single Well Cooling Tower Water Pump Tank Piping System</i> .....	33
	<i>Typical Dual Well Cooling Tower Pump Tank Piping System</i> .....	34
	<i>Typical Single Well Chilled Water Pump Tank Piping System</i> .....	35
	<i>Typical Dual Well Chilled Water Pump Tank Piping System</i> .....	36

# Chapter 1: Safety

---

## 1-1 How to Use This Manual

Use this manual as a guide and reference for installing, operating, and maintaining your equipment. The purpose is to assist you in applying efficient, proven techniques that enhance equipment productivity.

This manual covers only light corrective maintenance. No other maintenance should be undertaken without first contacting a service engineer.

The Functional Description section outlines models covered, standard features, and optional features. Additional sections within the manual provide instructions for installation, pre-operational procedures, operation, preventive maintenance, and corrective maintenance.

The Installation chapter includes required data for receiving, unpacking, inspecting, and setup of the equipment. We can also provide the assistance of a factory-trained technician to help train your operator(s) for a nominal charge. This section includes instructions, checks, and adjustments that should be followed before commencing with operation of the equipment. These instructions are intended to supplement standard shop procedures performed at shift, daily, and weekly intervals.

The Operation chapter includes a description of electrical and mechanical controls, in addition to information for operating the equipment safely and efficiently.

The Maintenance chapter is intended to serve as a source of detailed assembly and disassembly instructions for those areas of the equipment requiring service. Preventive maintenance sections are included to ensure that your equipment provides excellent, long service.

The Troubleshooting chapter serves as a guide for identification of most common problems. Potential problems are listed, along with possible causes and related solutions.

The Appendix contains technical specifications, drawings, schematics, and parts lists. A spare parts list with part numbers specific to your machine is provided with your shipping paperwork package. Refer to this section for a listing of spare parts for purchase. Have your serial number and model number ready when ordering.

### **Safety Symbols Used in this Manual**

The following safety alert symbols are used to alert you to potential personal injury hazards. Obey all safety messages that follow these symbols to avoid possible injury or death.

**Danger!** *DANGER indicates an imminently hazardous situation which, if not avoided, will result in death or serious injury.*

**Warning!** *WARNING indicates a potentially hazardous situation or practice which, if not avoided, could result in death or serious injury.*

**Caution!** *CAUTION indicates a potentially hazardous situation or practice which, if not avoided, may result in minor or moderate injury or in property damage.*

## 1-2 Warnings and Precautions

Our equipment is designed to provide safe and reliable operation when installed and operated within design specifications, following national and local safety codes.

To avoid possible personal injury or equipment damage when installing, operating, or maintaining this equipment, use good judgment and follow these safe practices:

- ☑ Follow all **SAFETY CODES**.
- ☑ Wear **SAFETY GLASSES** and **WORK GLOVES**.
- ☑ Disconnect and/or lock out power before servicing or maintaining the equipment.
- ☑ Use care when **LOADING, UNLOADING, RIGGING, or MOVING** this equipment.
- ☑ Operate this equipment within design specifications.
- ☑ **OPEN, TAG, and LOCK ALL DISCONNECTS** before working on equipment. You should remove the fuses and carry them with you.
- ☑ Make sure the equipment and components are properly **GROUND** before you switch on power.
- ☑ When welding or brazing in or around this equipment, make sure **VENTILATION** is **ADEQUATE. PROTECT** adjacent materials from flame or sparks by shielding with sheet metal. An approved **FIRE EXTINGUISHER** should be close at hand and ready for use if needed.
- ☑ Refrigeration systems can develop refrigerant pressures in excess of 500 psi (3,447.5 kPa/ 34.47 bars). **DO NOT CUT INTO THE REFRIGERATION SYSTEM. This must be performed by a qualified service technician only.**
- ☑ Do not restore power until you remove all tools, test equipment, etc., and the equipment and related components are fully reassembled.
- ☑ Only **PROPERLY TRAINED** personnel familiar with the information in this manual should work on this equipment.

We have long recognized the importance of safety and have designed and manufactured our equipment with operator safety as a prime consideration. We expect you, as a user, to abide by the foregoing recommendations in order to make operator safety a reality.

## 1-3 Responsibility

These machines are constructed for maximum operator safety when used under standard operating conditions and when recommended instructions are followed in the maintenance and operation of the machine.

All personnel engaged in the use of the machine should become familiar with its operation as described in this manual.

Proper operation of the machine promotes safety for the operator and all workers in its vicinity.

Each individual must take responsibility for observing the prescribed safety rules as outlined. All warning and danger signs must be observed and obeyed. All actual or potential danger areas must be reported to your immediate supervisor.

# Chapter 2: Functional Description

---

## 2-1 Models Covered in This Manual

This manual covers many models of cooling tower pump tanks and chilled water pump tanks with operating capacities of 100 to 6,125 gallons (378 to 23,183 liters). Pump tanks are designed, specified, and engineered to meet the needs of the process specified at the time of purchase. Model numbers are listed on the serial tag.

Model numbers start with a **CT** or **CW** to describe cooling tower or chilled water tank configurations. The number following is the approximate capacity up to the overflow of the tank well(s) and a **D** at the end indicates a dual well configuration. Additional numbers are added to signify pump horsepower. For example, a CT1600D-20-20-10 pump tank is a cooling tower tank, 1,615 gallon (6,113 liter) capacity to its overflow, has dual wells, a 20 hp process pump, a 20 hp dual standby pump and a 10 hp recirculation pump.

A model number followed by **-Q** is specially-constructed, and the information in this manual may not apply. Make sure you know the model and serial number of your equipment before contacting the manufacturer for parts or service.

## 2-2 General Description

Single well pump tanks are reservoirs for chilled water and tower cooling water processes. Process pump(s) deliver water through the chiller or cooling tower as well as through the process. Dual well tanks have re-circulation pump(s) to deliver water from the hot side to the chiller or tower. The water then returns to the cold side, where process pump(s) deliver cooled water directly to process.

Standby pumps may be used as backups for both process and re-circulation during service or maintenance procedures. Manifolding options provide ease of connection to process and can ease the transition to standby pumps.

## 2-3 Standard Features

All tower and chilled water pump tanks come standard with the following:

- ODP motors and cast iron impellers on standard pumps
- Centrifugal pump(s) with cast iron housings, cast iron impellers and mechanical seals
- Solid diamond-plate pump ledge
- Standard hardware includes thermometer(s), compound liquid-filled pump pressure gauge(s) with trim, and drain valve
- Heavy gauge 304 stainless steel construction.

**Note:** *Despite its name, stainless steel is still susceptible to discoloration. A stainless steel tank will not “rust through” even though the surface of the metal may appear to be rust colored. This appearance may be caused by water quality (high chloride content or increased acidity in the water) or cross contamination from carbon steel dust in the vicinity of the stainless steel. The integrity of the stainless steel remains in tact even though its appearance is not perfectly clean.*

- Factory-installed insulation and covers (chilled water pump tanks)
- Water strainer basket on cooling tower water pump tank models
- Threaded (up to 3” and flanged 4” and above) overflow opening, return openings (chilled water pump tanks), and process water return (dual-well cooling tower pump tanks)
- 1” automatic water makeup valve for “hands-off” level control
- 1/2” opening for field-installed thermometer
- 2” valved drain connection
- Twin 1/2” plugged openings for sight glasses
- Six 1/2” plugged openings with brackets for optional/future thermostats
- Baffles and sidewall reinforcements on larger models
- Full-size pump trim for maximum efficiency including butterfly valve (less handle) and reducer (if necessary) on the suction side; increaser, check valve and butterfly valve (less handle) on the discharge side
- One year warranty on parts and labor (labor in North America only)



## 2-4 Optional Features

All cooling tower and chilled water pump tanks are available with the following:

- Standby pump
- Frame reinforcement for supporting other equipment
- Special paint
- Mild steel well and fittings (divider if applicable)
- Second pump ledge
- Support legs
- OSHA handrail and ladder
- Thermostat and thermowell
- Extra thermostats and plugged 1/2" NPT thermostat openings
- High- and/or low-temperature alarm
- High- and/or low-pressure alarm
- High- and/or low-level alarm
- No flow alarm
- Re-circulating (P2) pump (standard on dual well tanks)
- Dual duty (P3) standby pump with isolation valving
- Additional plugged or valved openings
- Clayton float valve
- Discharge manifold with process and re-circulation pump standby butterfly valving
- NEMA 1 pump starter(s), mounted or un-mounted
- NEMA 12-rated central control panel
- Protection for outdoor installation

Chilled water pump tanks are also available with:

- Automatic pressure regulating bypass valve for single well tanks; assures full flow through the chiller evaporator

Cooling tower water pump tanks are also available with:

- Insulation
- Cover

# Chapter 3: Installation

---

## 3-1 Uncrating Your Pump Tank

**Caution!** *Due to the size and weight of larger model pump tanks, the manufacturer recommends using bonded professional millwrights to unload and move larger pump tanks.*

Rig the pump tank from the frame only and use spreader bars to prevent load transfer to any pump tank components. Rig the frame from at least four points and balance the load before lifting to clear the skid.

## 3-2 Installation Location Considerations

Consider the following points when locating your pump tank:

- Locate close to the chillers and/or cooling towers and the process itself to minimize field piping expense
- Locate adjacent to drain and city water sources
- Consult a structural engineer to assure that the floor, mounting pad, or structural steel support is of adequate strength

## 3-3 Rigging

Due to the large size and weight of the pump tanks, we recommend professional rigging and installation. We have a nationwide installation organization that can install your system.

Do not remove the base skid until the unit is at the final location. Lower the unit (do not drop it) from any truck, platform, or shipping dock.

All 150 through 400 Series pump tanks are provided with lifting lugs on the pump tank frame. All 500 Series and larger tanks are provided with lifting lug brackets on the pump tank body. When lifting, use adequately rated hoist, lifting straps and/or chains. Avoid transferring the load to the pumps and any other components.

Metal pump tanks are provided with slots in the frame for use with fork trucks of sufficient capacity and properly sized forks.

### 3-4 Installing Separate Tank Ledge Models

Pump tanks from the 2000, 2700, 3700, and 5100 Series are a two-component design with separate tank and pump ledge assemblies.

These models include a hardware package and assembly drawing located in the information packet. The tank and pump ledge were temporarily joined together at the factory, so all components should line up properly in the field.

General guidelines for installation are the following:

- Two-piece models are not designed to be lifted as a unit. Fully and separately support both tank and ledge assemblies when they are moved.
- Providing a level area for the tank installation will simplify reconnecting the pump ledge to the tank.
- Floor mounted tanks and ledges are joined together with support plates and the pump trim. Gravity and mass provide most of the structural integrity.
- Leg-mounted tanks and ledges are joined together with support plates, the pump trim, and bolts between the facing surfaces of the tank and ledge. Typically, the tank assembly is lifted and mounted on the four legs first, then the pump ledge is lifted with a fork truck, and the two remaining legs are attached. Use the center leg bolt holes and the facing surface bolts to bring together and align the ledge and the tank. See assembly drawings on pages 28-30 for detailed instructions.
- Butterfly valves bridge the gap between the ledge and tank flanges. These butterfly valves may be shipped loose or mounted to the pump suction connection to the tank.
- The flanges may not always line up as expected due to the tendency of the metal to move as it cools. Extra effort may be required to help align the flanges to bring the tank sections together properly.

**Caution!** *Improper handling may also cause movement of the flanges. Be sure the lifting lugs or forklift holes are used for moving the tank and base. Do not use any of the piping as a means of moving the equipment into position.*

### 3-5 Installing Optional Equipment

See pages 28 to 32 in the Appendix for assembly details for the tank legs, ladder, and sight glass.

### 3-6 Making Electrical Connections

Supply electricity of the voltage, phase, and cycle listed on the serial tag. Pump motor voltage must be within plus or minus ten percent of the nameplate voltages.

**Pump Starters.** Pump motor starters may be pre-mounted, shipped loose, or not provided, depending on the options specified on the order.

**On/Off Selector Switch.** All pump starters are supplied with an on/off selector switch on the starter enclosure cover.

### 3-7 Making Piping Connections

Piping systems vary with process application and pump tank configuration. Typical system configurations are available in the Appendix, but the details may or may not apply to your application. Refer to Figure 1 on page 13 for pipe sizing guidelines. Piping systems must be designed by a person knowledgeable in piping system design and configuration. Our contracting department can design and install a piping system tailored to your process.

All process piping returning to the pump tank must be equipped with an inverted trap with a vacuum breaker at the high point of the system to prevent mains from siphoning into the pump tank.

Run mains full size in order to reduce pressure drop in the system and provide maximum pressures at the ends of the mains.

**Caution!** *Do not support piping from the tank or from pumps. Do not weld piping or piping supports to the tank, as epoxy coating on some tank models can be damaged.*

**Caution!** *Customer is responsible for converting connections to metric sizes as needed.*

**Figure 1: Pipe Sizing Guide**

<b>Pipe Sizing Guide</b>		
<b>Pipe Size</b>	<b>Flow-Steel Pipe</b>	<b>Flow-PVC Pipe</b>
1/2	2	2
3/4	5	5
1	10	10
1 1/4	20	20
1 1/2	30	30
2	50	55
2 1/2	100	100
3	160	160
4	320	320
6	900	1000
8	2000	2100
10	3500	3700
12	5000	5800

Based on 10' head loss/100' of pipe (new pipe) — open piping systems. A safety factor of 15 to 20% should be added based on local conditions.

### ***Tower Tank Piping Connections***

**Return From Process (Single Well).** Connect process return piping to the cooling tower inlet with appropriate balancing valves and gauges. Size this line to the tower flow rate.

**Return From Process (Dual Well).** Connect process return piping to the hot well. Size piping to the process flow rate.

**Re-circulation Pump Discharge (Dual Well).** Connect to the cooling tower inlet with appropriate balancing valves and gauges. Size according to the pump discharge rate.

**Return From Tower.** The return from the tower outlet enters the pump tank from above and terminates above the water level at the water strainer basket location directing flow through the basket. Cut the end of the line at a 45° angle.

**Makeup.** Connect a 1" (approximately 25 mm) water line from a city water source to the makeup inlet to maintain the water level in the pump tank. City water pressure should not exceed 30 psi pressure. Check local codes. Backflow preventer may be required.

**Overflow.** Connect the overflow outlet to an approved, trapped drain to permit excess water in the pump tank to overflow to the drain. Size the overflow line according to the size of the pump tank. (Consult specifications on page 21.)

**To Drain.** Connect this outlet to a 2" (approximately 51 mm) line leading to an approved, trapped drain.

**Process Pump Discharge.** Connect the pump discharge to the process water supply main. Size the pipe to the pump discharge rate to the tower.

### ***Chilled Water Piping Connections***

**Process Pump Discharge (Single Well).** Connect process pump discharge to the chiller evaporator water inlet. Size to the chilled water flow rate. Chiller evaporator inlet and outlet should have valves and temperature and pressure gauges. Outlet of the evaporator is connected to the chilled process water supply.

**Process Pump Discharge (Dual Well).** Connect directly to the chilled water process supply. Size according to process flow requirements.

**Return (Single Well).** Connect the chilled water returning from the process to the pump tank threaded return inlet. Size this line according to the chilled water flow rate.

**Makeup.** Connect a 1" (approximately 25 mm) water line from a city water source to the makeup inlet to maintain the water level in the pump tank.

**Overflow.** Connect the overflow outlet to an approved, trapped drain to permit excess water in the pump tank to overflow to the drain. Size the overflow line according to the size of the pump tank. (Consult specifications on page 23.) Do not connect to draw if glycol is used in the system.

**To Drain.** Connect to a 2" (approximately 51 mm) line leading to an approved, trapped drain. Do not connect to draw if glycol is used in the system.

**Bypass (Single Well).** Optional: recommended on single pump systems. Pipe full size to the pressure-regulating valve from the evaporator outlet to allow flow if process does not require flow, to ensure proper flow through the evaporator at all times.

## **3-8 Initial Start-up**

- Remove all tools, foreign matter and debris from the pump tank reservoir and piping.
- Complete all piping leading to and from the pump tank. Observe all applicable codes.
- Complete all electrical wiring. Observe all applicable codes.
- Prepare all related equipment in the system for operation.
- Leak check piping. Flush and clean system.

# Chapter 4: Operation

---

## 4-1 Start-up

1. Close the drain line at the bottom of the pump tank.
2. Open the 1" makeup water valve and allow the tank to fill until the automatic float valve shuts off. Adjust the float level so the standing water level is 16" from the top of the tank, 12" on 150 Series pump tanks. Some tower systems may require a lower level to allow for drawback from the cooling towers.
3. Check all wiring integrity, field installed controls and voltage.
4. Verify pump motor rotation: should be clockwise from the motor end.
5. Open all pump suction valves fully and lock down.
6. If the process piping is not full of water, close the discharge valves of a process pump and start that pump. Open the discharge valve very slowly to fill the system. Do this very slowly to prevent the piping from shaking resulting in possible breakage. When piping is full, the discharge valve can be left fully open, if the pump is a non-overloading pump. Follow the same procedure for the other process pumps.
7. Repeat step 6 for re-circulating pumps. Leave pump discharge valve(s) fully open. Throttle the valves for proper flow and pressure drop. Lock down and mark valve(s) when complete. (On metal towers, throttle the pump for the flow rate and balance the valves on the hot basin(s) for proper depth.)

## 4-2 Determining Flow Rate

1. Close the gauge cock leading to the pump suction side, and open the gauge cock leading to the pump discharge.
2. Start the pump and make note of the discharge pressure in psi (kPa/bars).
3. Check the pump curve (See page 25) for the appropriate sample curve discharge pressure in psi (kPa/bars).
4. Project this point down to find the flow in gpm (lpm).



### **4-3 Stand-by Pump Usage**

All stand-by pumps should be checked intermittently to make sure they are operational for when they may be required for usage.

#### ***Single Stand-by pump:***

1. Open the suction valve fully and lock down.
2. Open the discharge valve slowly until it is equal to the pump it will be replacing.
3. Shut down the pump being replaced and make sure the suction and discharge valves are fully closed.

#### ***Dual Stand-By Pump***

1. Open the discharge manifold valve on the proper side of the divider for the pump being replaced. Be sure the opposite discharge manifold valve is fully closed.
2. Open the suction valve on the proper side of the divider for the pump being replaced. Be sure the opposite suction valve is fully closed.
3. Open the discharge valve slowly until it is equal to the pump it will be replacing.
4. Shut down the pump being replaced and make sure the suction and discharge valves are fully closed.

### **4-4 Shut-down**

1. Prepare all process and related equipment for shutdown.
2. Shut down all pumps
3. Close the water makeup valve.
4. If you are draining the system, open the 2" drain valve.

# Chapter 5: Maintenance

---

## 5-1 Preventative Maintenance

### ***Water Treatment***

Control of slime, algae, and bacteria growth is extremely important. Cooling towers and reservoir pump tanks are superb environments for microorganism growth. Warm water, organic debris, and air encourage bacterial growth. Treat your system with chemicals (microbiocides) to control microorganism growth.

**Caution!** *Uncontrolled microorganism growth causes system problems such as fouling and corrosion, and can spread bacterially-transmitted diseases.*

You must reduce slime growth and bacterial contamination to eliminate disease-causing bacteria.

Properly used, environmentally approved microbiocide controls system bacteria. Chemical treatments must be regularly monitored by qualified personnel.

The manufacturer strongly recommends use of EPA-registered microbiocides on a regular basis. We do NOT recommend use of chlorine or backyard swimming pool chemicals. Permitting the discharge of such chemicals into a city sewer may violate local, state, and/or federal laws.

We offer a full-service water treatment program including chemicals, dispensing equipment, automatic bleed-off, and monthly water analysis. Contact the Parts and Service department for more information.

### ***Lubricating Pump Motors and Seals***

Some pump motors require greasing; use a high grade ball and roller bearing grease such as Shell Dolium R or Chevron SR1. Motors with regreasable bearings are shipped with a high quality, wide temperature range grease.

**Caution!** *Pump seals require water for lubrication, so the pumps must never be run dry or be dead headed.*

Always fill the tank before attempting to operate the pumps. Seal failures usually result from running the pump dry.

### ***Maintaining Makeup Valve Assemblies***

Periodically inspect the water makeup valve assembly for proper operation. If the valve no longer shuts off completely or reliably, replace it. Make sure that the plastic ball float is buoyant for proper operation.

# Chapter 6: Appendix

---

## 6-1 Technical Assistance

### ***Parts Department***

Call toll-free 7am–5pm CST [800] 423-3183 or call [262] 641-8610, Fax [262] 641-8653

The ACS Customer Service Group will provide your company with genuine OEM quality parts manufactured to engineering design specifications, which will maximize your equipment's performance and efficiency. To assist in expediting your phone or fax order, please have the model and serial number of your unit when you contact us. A customer replacement parts list is included in this manual for your convenience. ACS welcomes inquiries on all your parts needs and is dedicated to providing excellent customer service.

### ***Service Department***

Call toll-free 8am–5pm CST [800] 423-3183 or call [262] 641-8610  
Emergencies after 5pm CST, call [847] 439-5655

We have a qualified service department ready to help. Service contracts are available for most of our products. [www.acscustomerservice.com](http://www.acscustomerservice.com)

### ***Sales Department***

Call [262] 641.8610 Monday—Friday, 8am—5pm CST, fax [262] 641-8653

Our products are sold by a world-wide network of independent sales representatives. Contact our Sales Department for the name of the sales representative nearest you.

### ***Contracting Department***

Call [262] 641-8610 Monday—Friday, 8am—5pm CST

Let us install your system. The Contracting Department offers any or all of these services: project planning; system packages including drawings; equipment, labor, and construction materials; and union or non-union installations.

**Sterling, Inc.**  
**5900 S. 160<sup>th</sup> Street**  
**New Berlin, WI 53151**  
**[www.sterlco.com](http://www.sterlco.com)**

## 6-2 Remote Starters and NEMA Panels

Pump tanks can be provided with electrical controls such as basic motor starters or elaborate NEMA panels.

Motor starters or NEMA panels can be shipped loose for field installation or pre-mounted for space saving convenience. Motor starters are equipped with on/off selector switches for turning the pump on with overload relays to protect the motor when operating. On tower systems, re-circulating pump and tower fan motor starter are also provided with thermostats for proper temperature. The chiller provides the temperature control on chilled water systems.

All starters require a 120-volt power source for the control circuit.

### ***NEMA Panel Standard Features***

The NEMA panel is a properly sized enclosure to house all the starters required for each pump tank system. A control circuit transformer is also provided to create the 120 volt control circuit needed for starters and thermostats. A power distribution block is provided to bring in main power to the panel. All internal wiring is provided and selector switches and indicator lights are provided on the NEMA panel door with labels to indicate each device.

### ***NEMA Panel Options***

Each panel can be customized beyond the basic setup. A list of some of the possible additions are as follows:

- Alarm circuitry with horn and strobe light
- High temperature alarm
- Low pressure alarm
- High pressure alarm
- Low flow alarm
- Low level alarm
- High level alarm
- Digital temperature display
- Amp meters
- Hour meters
- Digital flow meters
- UL panel
- Automatic water make-up
- Variable speed systems

## 6-3 Drawings and Specifications

### Cooling Tower Water Pump Tanks

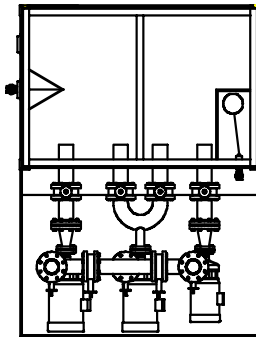

Top View

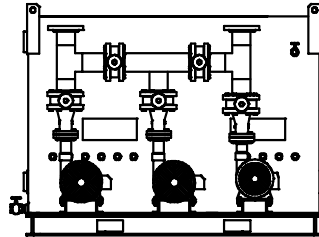

Front View

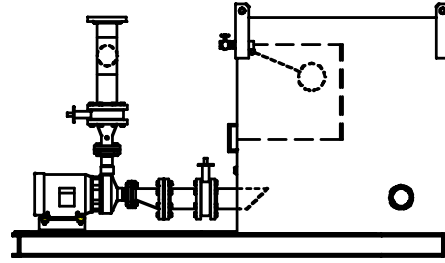

Side View  
(P2 Pump Shown Only For Clarity)

### American Standards

Model number	Maximum tower tons ①		Capacity		Maximum pumps/ ledge	Return water & overflow connections	Dimensions			Tank weight (less pumps)	
	Single well	Dual well	gallons				inches			pounds	
			Overflow	Operating			L	W	H	Shipping	Operating
CT140 (D)	25	13	125	100	3	3" NPT	72	36	40	600	1,800
PT390 (D) ②	78	39	390	350	3	⌀ 5" CLMP	95	56	64	500	3,500
CT480 (D)	90	45	450	360	3	4" FLG	102	49.5	52	2,000	6,000
CT720 (D)	135	68	675	540	4	4" FLG	114	73.5	52	2,600	8,600
CT1080 (D)	206	103	1,030	900	4	6" FLG	114	73.5	77	3,400	12,400
CT1620 (D)	310	155	1,550	1,345	4	6" FLG	138	73.5	77	4,000	17,500
CT2040 (D)	382	191	1,910	1,685	5	6" FLG	150	91	78	5,000	22,100
CT2700 (D)	509	225	2,545	2,245	6	6" FLG	150	121	78	6,000	28,500
CT3670 (D)	698	349	3,490	3,140	6	6" FLG	162	121	90	7,000	37,600
CT5130 (D)	978	489	4,890	4,400	7	⌀ 8" FLG	162	169	92	7,800	50,700
CT6285 (D)	1,257	629	6,285	5,655	9	⌀ 10" FLG	162	217	94	14,700	69,100

① Based on three (3) gpm per ton and towers being within 25 feet of the tank.

② "P" signifies molded polyethylene tank.

⌀ PT390 = 6" CLMP, CT5130 = 6" FLG, CT6285 = 8" FLG overflow connections only.

### Metric Standards

Model number	Maximum tower cooling ①		Capacity		Maximum pumps/ ledge	Return water & overflow connections	Dimensions			Tank weight (less pumps)	
	Single well	Dual well	liters				cm			Kg	
			Overflow	Operating			L	W	H	Shipping	Operating
CT140 (D)	94,615	49,200	473	378	3	76 mm	183	91	102	273	817
PT390 (D) ②	295,200	147,599	1,476	1,325	3	⌀ 127 mm	241	142	162	227	1,588
CT480 (D)	340,619	170,303	1,703	1,362	3	102 mm	259	126	132	908	2,722
CT720 (D)	510,921	257,353	2,555	2,044	4	102 mm	289	187	132	1,180	3,901
CT1080 (D)	779,628	389,814	3,899	3,407	4	152 mm	289	187	195	1,543	5,625
CT1620 (D)	1,173,195	586,613	5,867	5,091	4	152 mm	350	187	195	1,815	7,938
CT2040 (D)	1,445,717	722,859	7,229	6,378	5	152 mm	381	231	198	2,268	10,025
CT2700 (D)	1,926,361	965,073	9,633	8,497	6	152 mm	381	307	198	2,722	12,928
CT3670 (D)	2,641,651	1,320,825	13,209	11,885	6	152 mm	411	307	229	3,176	17,056
CT5130 (D)	3,701,339	1,850,669	18,509	16,654	7	⌀ 203 mm	411	429	234	3,539	22,998
CT6285 (D)	4,757,242	2,380,513	23,789	21,404	9	⌀ 254 mm	411	551	239	6,668	31,344

① In Kcal/hr, calculated for cooling tower water, based on 3 lpm per 1,000 Kcal/hr and towers being within eight (8) meters of the tank.

② "P" signifies molded polyethylene tank.

⌀ PT390 = 152mm, CT5130 = 152mm, CT6285 = 203mm overflow connections only.

**Figure 2: Standard Pumps and Trim Based on Cooling Tower Capacities**

(Flow Based on 3 gpm per Ton)

**American Standards**

Capacity		Trim size inches	Process pump hp	Recirculating pump hp
Nominal cooling tower tons	Nominal flow gallons			
20	60	2½"	5	3
30	90	2½"	7½	3
40	120	3"	7½	5
50	150	3"	10	5
60	180	4"	10	5
75	225	4"	15	7½
80	240	4"	15	7½
100	300	4"	20	7½
125	375	6"	20	10
150	450	6"	25	10
175	525	6"	30	15
200	600	6"	30	15
250	750	6"	40	20
300	900	6"	50	20

Pump horsepower	1½	3	5	7½	10	15	20	25	30	40	50	60
Amp draw 460/3/60	2.6	4.8	7.6	11	14	21	27	34	40	52	65	77
Shipping weight (lbs.) • P1	—	95	115	125	165	180	300	310	400	465	710	730
• P2	60	90	115	275	320	425	510	630	670	—	—	—

Trim size (inches)	2	2½	3	4	6	8
Maximum flow (gpm)	50	90	160	320	900	2,000
Shipping weight (lbs.)	25	35	50	75	120	165

**Metric Standards**

Capacity		Trim size mm Dia.	Process pump		Recirculating pump	
Nominal refrigeration Tower water, Kcal/hr	Nominal flow liters		hp	kW	hp	kW
75,600	227	64	5	3.73	3	2.24
113,400	341	64	7½	5.59	3	2.24
151,200	454	76	7½	5.59	5	3.73
189,000	568	76	10	7.50	5	3.73
226,800	682	102	10	7.50	5	3.73
283,500	852	102	15	11.19	7½	5.59
302,400	909	102	15	11.19	7½	5.59
378,000	1,135	102	20	14.91	7½	5.59
472,500	1,419	152	20	14.91	10	7.50
567,000	1,703	152	25	18.64	10	7.50
661,500	1,987	152	30	22.37	15	11.19
756,000	2,271	152	30	22.37	15	11.19
945,000	2,839	152	40	29.93	20	14.91
1,134,000	3,406	152	50	37.29	20	14.91

Pump horsepower/kW	1½/1.12	3/2.24	5/3.73	7½/5.59	10/7.5	15/11.19	20/14.91	25/18.64	30/22.37	40/29.93	50/37.29	60/44.74
Amp draw 460/3/60	2.6	4.8	7.6	11	14	21	27	34	40	52	65	77
Ship weight (Kg) • P1	—	44	53	57	75	82	137	141	182	211	323	332
• P2	28	41	53	125	146	193	232	286	304	—	—	—

Trim size (inches)	2	2½	3	4	6	8
Maximum flow (lpm)	189	340	624	1,211	3,406	7,570
Shipping weight (Kg)	12	16	23	35	55	75

## Chilled Water Pump Tanks

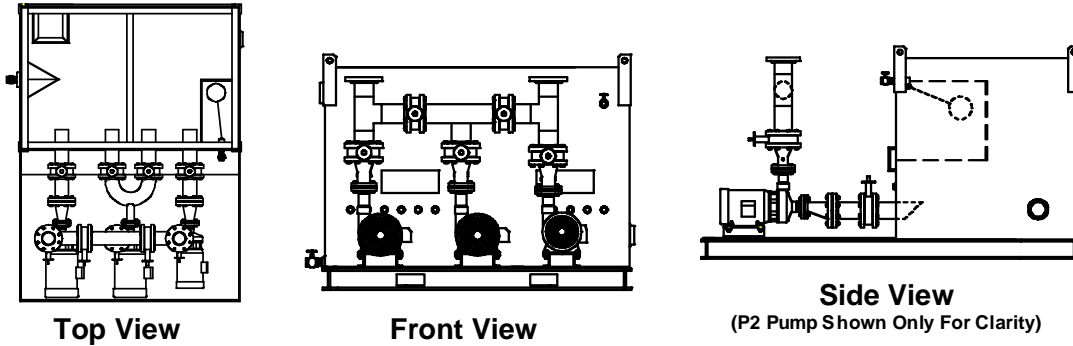

### American Standards

Model number	Maximum tons chilled H <sub>2</sub> O ①		Capacity		Maximum Pumps/ Ledge	Return water & overflow Connections inches	Dimensions			Tank weight (less pumps)	
	Single well	Dual well	gallons				L	W	H	pounds	
			Overflow	Operating						Shipping	Operating
CW140 (D)	47	23	125	110	3	3" NPT	72	36	40	600	1,800
PC390 (D) ②	146	73	390	350	3	⌘ 5" CLMP	95	56	64	500	3,500
CW480 (D)	175	87	450	420	3	4" FLG	102	49.5	52	2,000	6,000
CW720 (D)	262	131	675	630	4	4" FLG	114	73.5	52	2,600	8,600
CW1080 (D)	411	206	1,030	990	4	6" FLG	114	73.5	77	3,400	12,400
CW1620 (D)	617	309	1,550	1,480	4	6" FLG	138	73.5	77	4,000	17,500
CW2040 (D)	771	386	1,910	1,850	5	6" FLG	150	91	78	5,000	22,100
CW2700 (D)	1,029	514	2,545	2,470	6	6" FLG	150	121	78	6,000	28,500
CW3670 (D)	1,418	709	3,490	3,405	6	6" FLG	162	121	90	7,000	37,600
CW5130 (D)	1,985	993	4,890	4,765	7	⌘ 8" FLG	162	169	92	7,800	50,700
CW6285 (D)	2,553	1,276	6,285	6,125	9	⌘ 10" FLG	162	217	94	14,700	69,100

① Based on 2.4 gpm per ton.

② "P" signifies molded polyethylene tank.

⌘ PC390 = 6" CLMP, CW5130 = 6" FLG, CW6285 = 8" FLG overflow connections only.

### Metric Standards

Model number	Maximum cooling, chilled H <sub>2</sub> O ①		Capacity		Maximum pumps/ ledge	Return water & overflow connections mm	Dimensions			Tank weight (less pumps)	
	Single well	Dual well	liters				L	W	H	Kg	
			Overflow	Operating						Shipping	Operating
CW140 (D)	177,876	87,046	473	416	3	76 mm	183	91	102	273	817
PC390 (D) ②	552,552	276,276	1,476	1,325	3	⌘ 127 mm	241	142	162	227	1,588
CW480 (D)	662,305	329,260	1,703	1,590	3	102 mm	259	126	132	908	2,722
CW720 (D)	991,565	495,783	2,555	2,385	4	102 mm	289	187	132	1,180	3,901
CW1080 (D)	1,555,471	779,628	3,849	3,747	4	152 mm	289	187	195	1,543	5,625
CW1620 (D)	2,335,098	1,169,441	5,867	5,602	4	152 mm	350	187	195	1,815	7,938
CW2040 (D)	2,917,927	1,460,856	7,229	7,002	5	152 mm	381	231	198	2,268	10,025
CW2700 (D)	3,894,353	1,945,284	9,633	9,349	6	152 mm	381	307	198	2,722	12,928
CW3670 (D)	5,366,263	2,683,281	13,209	12,888	6	152 mm	411	307	229	3,176	17,056
CW5130 (D)	7,512,431	3,758,108	18,509	18,036	7	⌘ 203 mm	411	429	234	3,539	22,998
CW6285 (D)	9,662,084	4,829,150	23,789	23,183	9	⌘ 254 mm	411	551	239	6,668	31,344

① In Kcal/hr, calculated for **chilled water**, based on 3 lpm per 1,000 Kcal/hr.

② "P" signifies molded polyethylene tank.

⌘ PC390 = 152mm, CW5130 = 152mm, CW6285 = 203mm overflow connections only.

**Figure 3: Standard Pumps and Trim Based on Chiller Capacities**

(Flow based on 2.4 gpm per ton)

**American Standards**

Nominal refrigeration tons	Capacity		Trim size inches	Process pump hp	Recirculating pump hp
	Nominal flow gallons				
25	60		2½"	5	3
35	84		2½"	7½	3
50	120		3"	7½	5
60	144		3"	10	5
75	180		4"	10	5
90	216		4"	15	7½
100	240		4"	15	7½
125	300		4"	20	7½
155	372		6"	20	10
185	444		6"	25	10
220	528		6"	30	15
250	600		6"	30	15
310	744		6"	40	20
375	900		6"	50	20

Pump horsepower	1½	3	5	7½	10	15	20	25	30	40	50	60
Amp draw 460/3/60	2.6	4.8	7.6	11	14	21	27	34	40	52	65	77
Shipping weight (lbs.) • P1	—	95	115	125	165	180	300	310	400	465	710	730
• P2	60	90	115	275	320	425	510	630	670	—	—	—

Trim size (inches)	2	2½	3	4	6	8
Maximum flow (gpm)	50	90	160	320	900	2,000
Shipping weight (lbs.)	25	35	50	75	120	165

**Metric Standards**

Nominal refrigeration, chilled water, Kcal/hr	Capacity		Trim size mm dia.	Process pump		Recirculating pump	
	Nominal flow liters			hp	kW	hp	kW
75,600	227		64 mm	5	3.73	3	2.24
105,840	318		64 mm	7½	5.59	3	2.24
151,200	454		76 mm	7½	5.59	5	3.73
181,440	545		76 mm	10	7.50	5	3.73
226,800	681		102 mm	10	7.50	5	3.73
272,160	818		102 mm	15	11.19	7½	5.59
302,400	908		102 mm	15	11.19	7½	5.59
378,000	1,136		102 mm	20	14.91	7½	5.59
468,720	1,408		152 mm	20	14.91	10	7.50
559,440	1,680		152 mm	25	18.64	10	7.50
665,280	1,998		152 mm	30	22.37	15	11.19
756,000	2,271		152 mm	30	22.37	15	11.19
937,440	2,816		152 mm	40	29.93	20	14.91
1,134,000	3,407		152 mm	50	37.29	20	14.91

Pump horsepower/kW	1½/1.1 2	3/2.24	5/3.73	7½/5.5 9	10/7.5	15/11.1 9	20/14.9 1	25/18.6 4	30/22.3 7	40/29.9 3	50/37.2 9	60/44.7 4
Amp draw 460/3/60	2.6	4.8	7.6	11	14	21	27	34	40	52	65	77
Ship weight (Kg) • P1	—	44	53	57	75	82	137	141	182	211	323	332
• P2	28	41	53	125	146	193	232	286	304	—	—	—

Trim size (mm)	51 mm	64 mm	76 mm	102 mm	152 mm	203 mm
Maximum flow (lpm)	189	340	624	1,211	3,406	7,570
Shipping weight (Kg)	12	16	23	35	55	75



### Process Pump Curves and Specifications

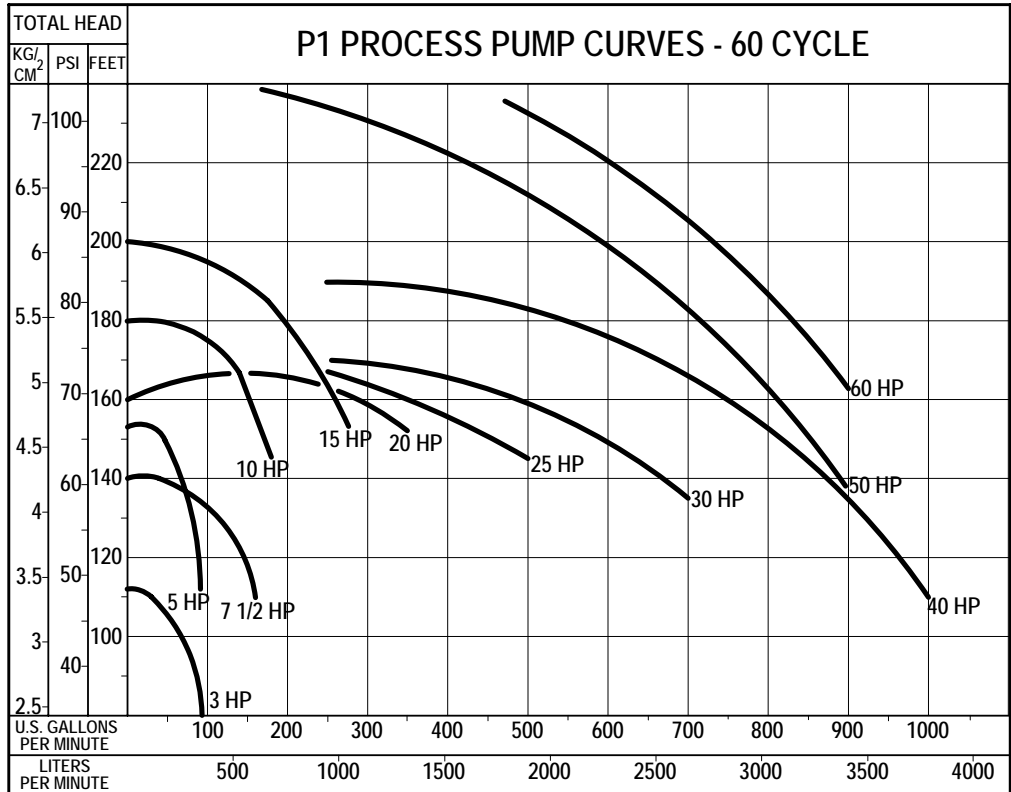

A0548756

Pump Information				Pump rpm	Final discharge trim size <sup>N</sup>	Pump ship wt.		Trim ship wt.	
Model	IMP.	hp	kW		inches	lbs.	kg	lbs.	kg
16	5.2"	3	2.24	3,500	2" NPT	95	44	25	12
50	6.0"	5	3.73	3,500	2½" flange	115	53	35	16
52	5.75"	7½	5.59	3,500	3" flange	125	57	50	23
52	6.5"	10	7.46	3,500	3" flange	165	75	50	23
54F	6.5"	15	11.19	3,500	4" flange	180	82	75	35
55F	6.5"	20	14.92	3,500	4" flange	300	137	75	35
56F	6.3"	25	18.65	3,500	6" flange	310	141	95	44
57	6.4"	30	22.38	3,500	6" flange	400	182	95	44
57	6.87"	40	29.84	3,500	6" flange	465	212	120	55
63	7.5"	50	37.30	3,500	6" flange	710	323	120	55
63	8.2"	60	44.76	3,500	8" flange	730	332	165	75

<sup>N</sup> Weld slip-on flange sent at discharge termination for flanged trim. 2" terminates at valve connection.

### Re-circulation Pump Curves and Specifications

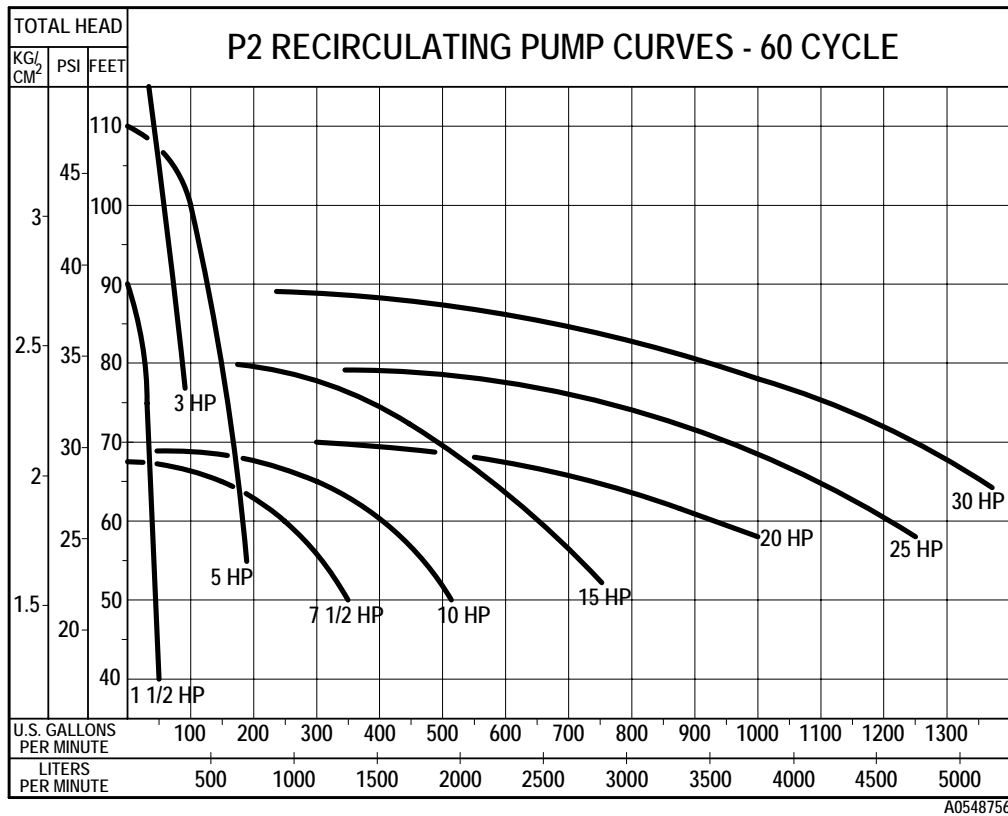

A0548756

Pump Information				Pump rpm	Final discharge trim size <sup>∞</sup> inches	Pump ship wt.		Trim ship wt.	
Model	IMP.	hp	kW			lbs.	kg	lbs.	kg
60	4.6"	1½	1.19	3,500	2" NPT	60	28	25	12
16	5.2"	3	2.24	3,500	2½" flange	90	41	50	23
17	5.3125"	5	3.73	3,500	3" flange	115	53	75	35
103	8.0"	7½	5.59	1,750	4" flange	275	125	75	35
104	8.0"	10	7.46	1,750	6" flange	320	146	95	44
95	8.6"	15	11.19	1,750	6" flange	425	193	120	55
96	8.9"	20	14.92	1,750	6" flange	510	232	120	55
96	9.37"	25	18.65	1,750	8" flange	630	287	165	75
96	9.75"	30	22.38	1,750	8" flange	670	305	165	75

<sup>∞</sup> Weld slip-on flange sent at discharge termination for flanged trim. 2" terminates at valve connection.

## 6-4 Parts List

### Recommended Spare Parts

Part number	Quantity	Description
A0550190	1	Pressure gauge
A0501073	1	Temperature gauge
A0069286	1 (if required)	Strainer basket, 12" (approx. 30.5 cm)
A0069285	1 (if required)	Strainer basket, 18" (approx. 45.7 cm)
A0102396	1	Float valve, 1" (approx. 25.4 mm)
A0069538	1	Plastic ball float, 6" (approx. 15.2 mm)
A0102394	1	Float rod, 10" (approx. 25.4 cm)

### Spare Process Pump Seals and Casing Gaskets

Pump Model	Process pump power		Pump seals		Pump casing gaskets	
	hp	kW	Part number	Qty	Part number	Qty
16	3	2.24	A05100581		A0101975	
50	5	3.73	A05100581		A0103509	
52	7½	5.59	A05100581		A0103509	
52	10	7.46	A05100581		A0103509	
54F	15	11.19	A05100581		A0103509	
55F	20	14.92	A05100581		A0103509	
56F	25	18.65	A05100581		A0103509	
57	30	22.38	A05104591		A0524321	
57	40	29.84	A05104591		A0524321	
63	50	37.30	A05104591		A0530385	
63	60	44.76	A05104591		A0530385	

### Spare Re-circulating Pump Seals and Casing Gaskets

Pump Model	Re-circulating pump power		Pump seals		Pump casing gaskets	
	hp	kW	Part number	Qty	Part number	Qty
60	1½	1.19	A0101975		A0101582	
16	3	2.24	A0100581		A0101975	
17	5	3.73	A0100581		A0101975	
103	7½	5.59	A0104591		A0104830	
104	10	7.46	A0104591		A0104830	
95	15	11.19	A0104591		A0530386	
96	20	14.92	A0104591		A0530386	
96	25	18.65	A0104591		A0530386	
96	30	22.38	A0104591		A0530386	

# 6-5 Optional Assembly Detail Drawings

## Tank Support Leg Assembly Detail: 4 Legs

**LEG CHART**

LEG HEIGHT	DIMENSION (X)	LENGTH (Y)
7'	24"	84"
8'	30"	42.5"
9'	36"	61"
10'	42"	61"
ADAPTS 10'	0"	0"

**TOP VIEW**  
PUMP TANK  
PUMP LEDGE  
1.7" SQUARE LEG TUBING (SEE DETAIL A)

**FRONT VIEW**  
PUMP TANK FRONT  
PUMP LEDGE  
SEE DETAIL B  
STANDARD 7" LEG SHOWN

**SIDE VIEW**  
PUMP TANK RIGHT SIDE  
PUMP LEDGE  
CHANNEL IRON SUPPORT FRAME  
FIELD WELDED TO FRAME (TYPICAL FOR B)  
3 x 3 x 1/4 ANGLE  
FIELD WELDED TO LEG (TYPICAL FOR B)  
STANDARD 7" LEG SHOWN

**DETAIL A**  
0.75" x 1.2" POWER RIVET  
45.00"

**DETAIL B**  
6.00"

**INSTALLATION NOTES:**

- TANK IS PROVIDED WITH 4 CORNER LEGS.
- REMOVE ASSEMBLY HARDWARE FROM LEGS PRIOR TO INSTALLATION.
- ELEVATE TANK AND SET LEGS UNDER TANK. (DETAIL B)
- MAKE SURE LEGS ARE LEVEL AND SQUARE. SHIM AS REQUIRED.
- BOLT TANK TO LEGS WITH BOLTS AND NUTS (3 PER LEG) PROVIDED.
- WELD LEGS TO FRAME OF PUMP TANK.
- ALL GUSSETS ARE TO BE FIELD WELDED IN POSITION.
- SEE TABLE FOR GUSSET DIMENSION, CONSULT FACTORY FOR LEGS ABOVE 10'.
- ANCHOR LEGS TO FLOOR. (DETAIL A)
- THIS INSTALLATION PROCEDURE DOES NOT CONFORM TO CALIFORNIA SEISMIC CODES.

**LIST OF MATERIALS:**

- WASHER, HEX., 1/2"
- NUT, HEX., 1/2"
- ANGLE, L.P., 3" x 3" x 1/4"
- CHANNEL, IRON, 12" x 12" x 1/2"
- PIPE, STEEL, 1.75" x 0.1875"
- PIPE, STEEL, 1.75" x 0.1875"
- PLATE, 1/2" THICK
- PLATE, 1/2" THICK
- PLATE, 1/2" THICK

**ITEM PART NO. DESCRIPTION QTY. U.M.**

1	AS022243	PLATE, 1/2" THICK	1	EA
2	AS022243	PLATE, 1/2" THICK	1	EA
3	AS022243	PLATE, 1/2" THICK	1	EA
4	AS022243	PLATE, 1/2" THICK	1	EA
5	AS022243	PLATE, 1/2" THICK	1	EA
6	AS022243	PLATE, 1/2" THICK	1	EA
7	AS022243	PLATE, 1/2" THICK	1	EA
8	AS022243	PLATE, 1/2" THICK	1	EA
9	AS022243	PLATE, 1/2" THICK	1	EA
10	AS022243	PLATE, 1/2" THICK	1	EA

**TOLERANCES**

XX	± 0.00
XXX	± 0.05
XXXX	± 0.10
XXXXX	± 0.15
ANGULAR	± 2'

**REVISIONS**

NO.	DATE	DESCRIPTION
1	10-11-07	ISSUED
2	10-11-07	ISSUED

**ASSEMBLY DETAIL - 4 LEGS**  
150 - 1600 SERIES TANKS

**REVISIONS**

NO.	DATE	DESCRIPTION
1	10-11-07	ISSUED
2	10-11-07	ISSUED

**SCALE** 1" = 1'

**PROJECT NO.** AO561993

# Tank Support Leg Assembly Detail: 6 Legs

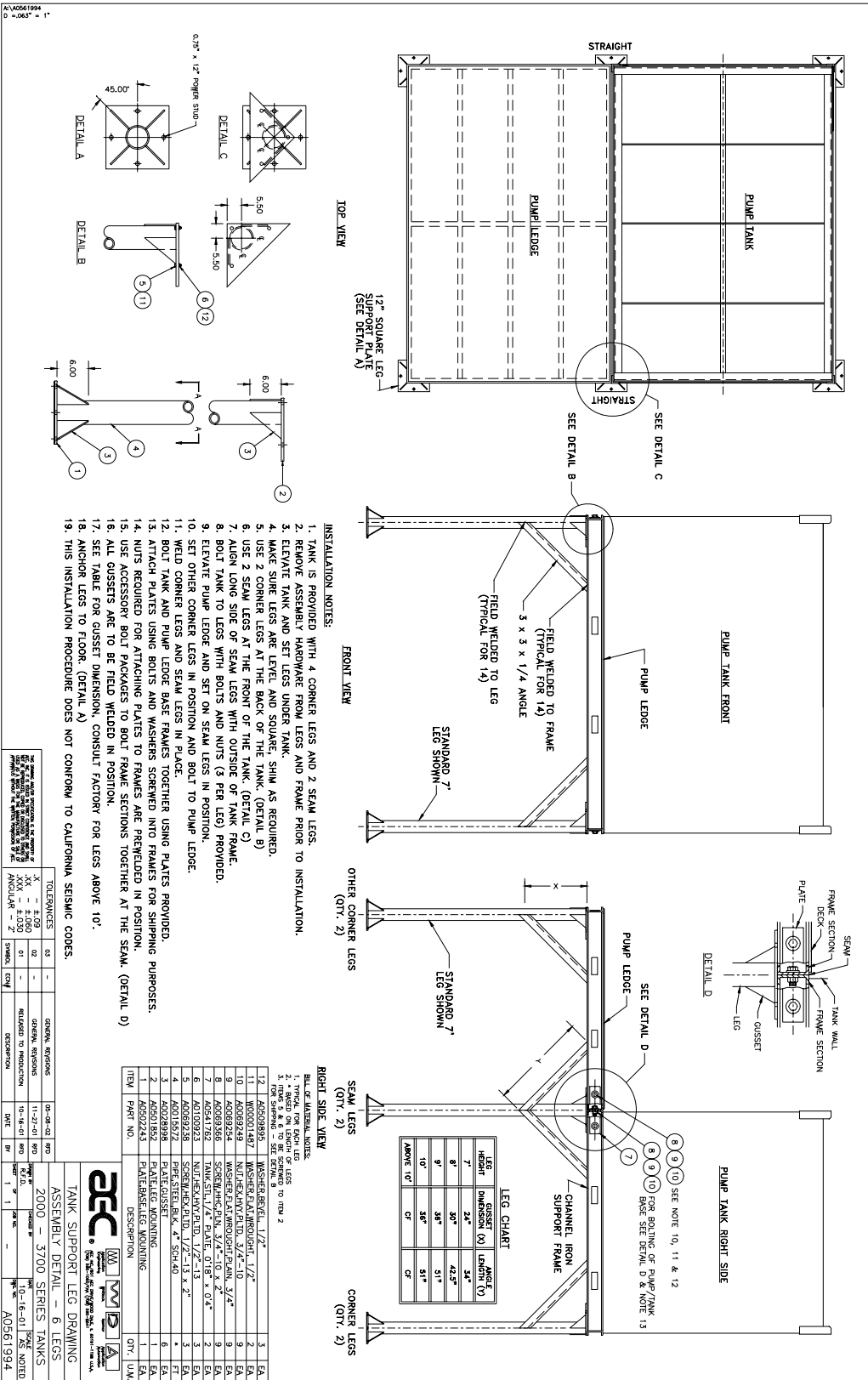

# Tank Support Leg Assembly Detail: 7 Legs

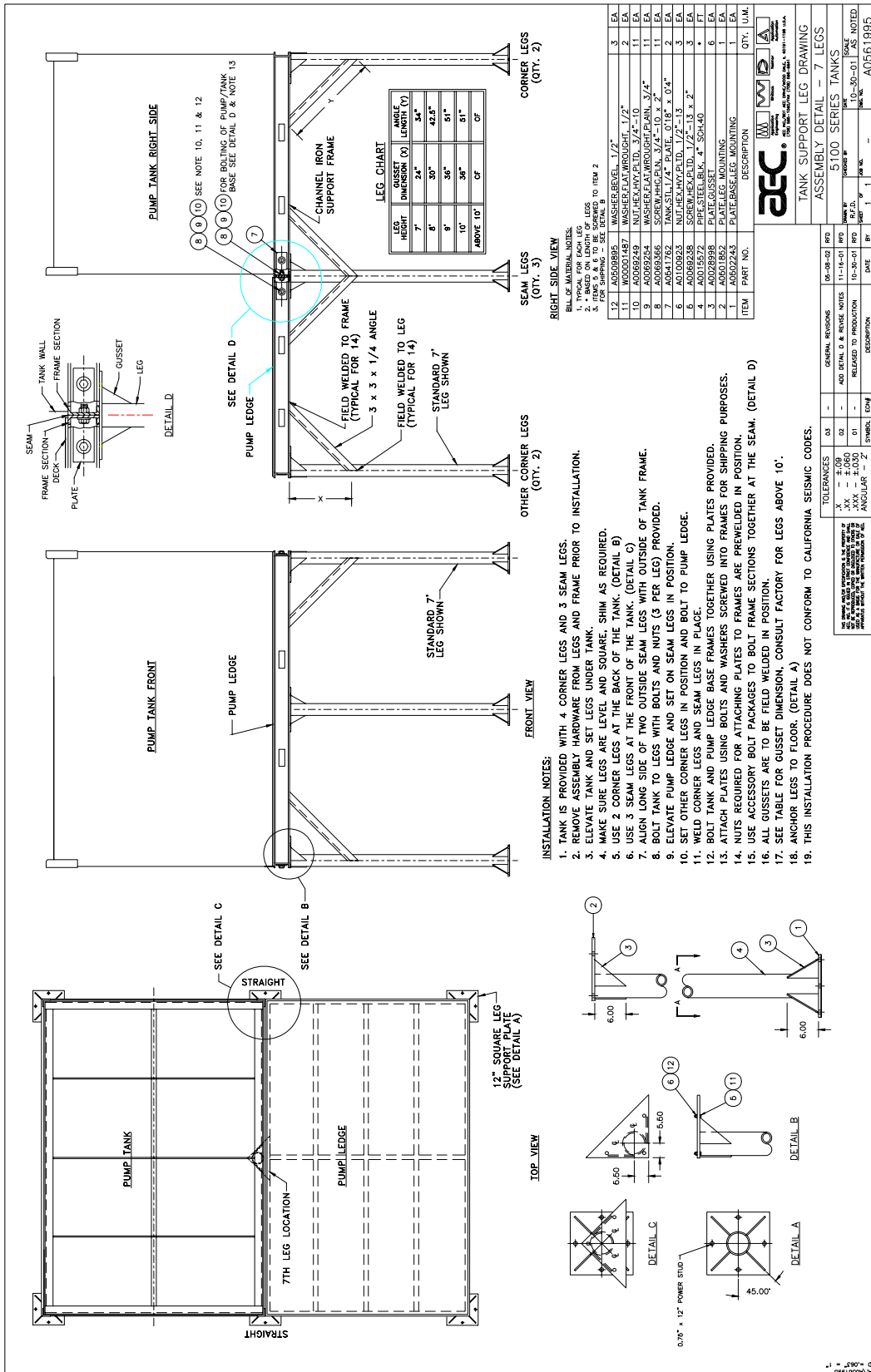

# Tank Ladder Assembly Detail

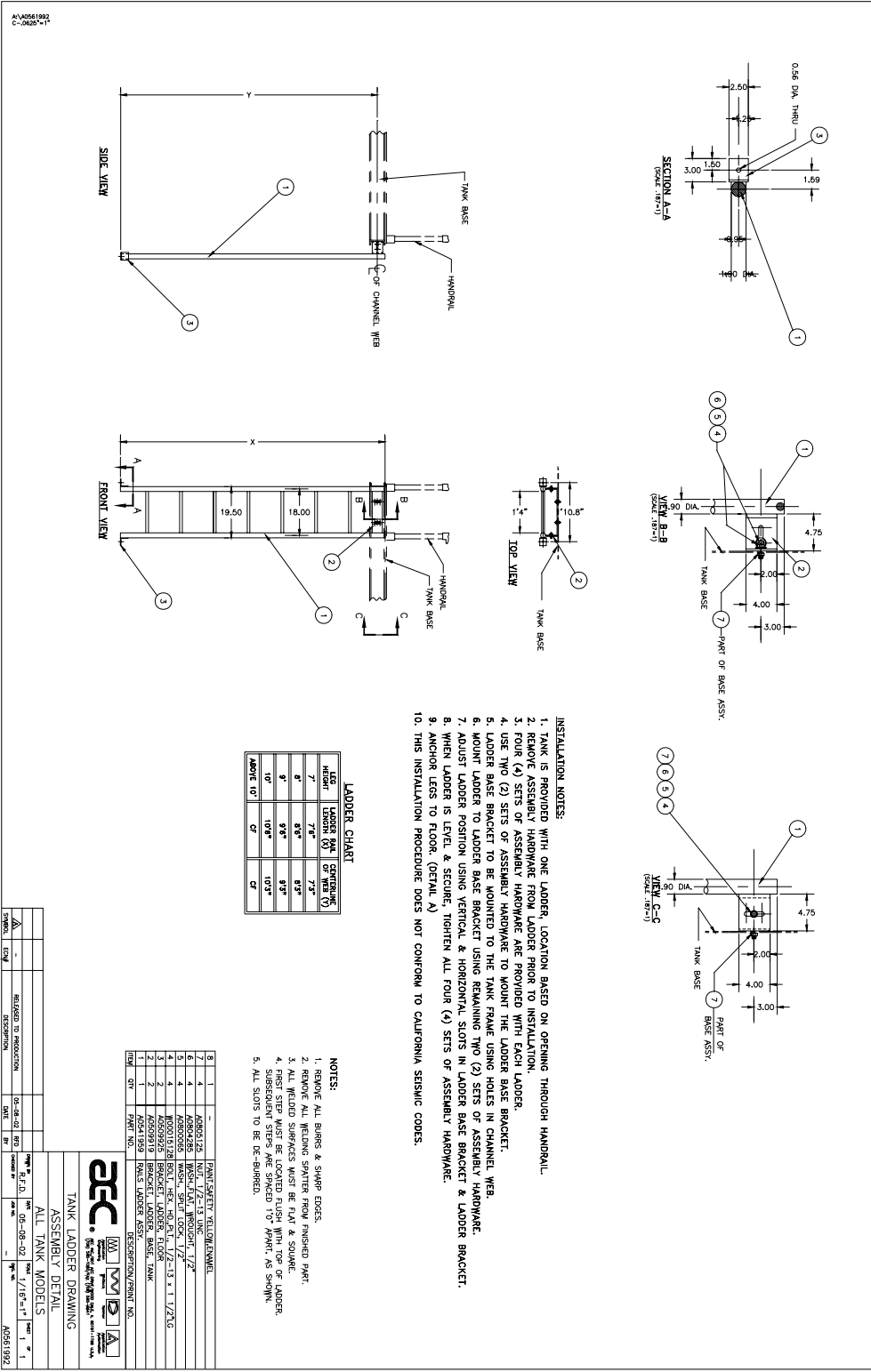

# Sightglass Assembly Detail

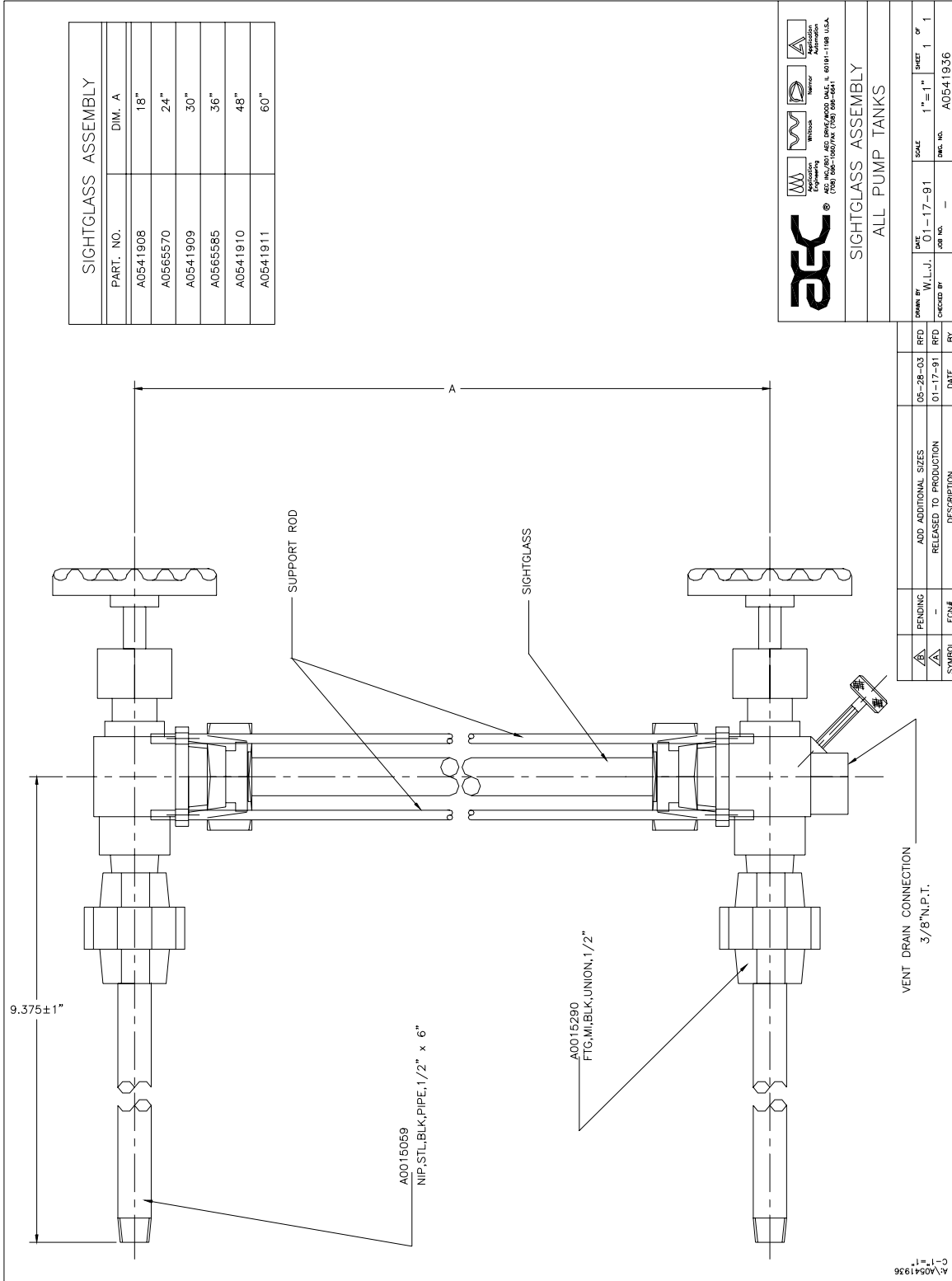

SIGHTGLASS ASSEMBLY	
PART. NO.	DIM. A
A0541908	18"
A0565570	24"
A0541909	30"
A0565585	36"
A0541910	48"
A0541911	60"

**PEC** PROFESSIONAL ENGINEERING CONSULTANTS  
 INC. 605/201 AED DRIVE/WOOD DALE, IL 60191-1108 U.S.A.  
 (708) 682-1000/FAX (708) 682-6641

SYMBOL: PENDING: ECNF:

DATE	BY	RFD	DATE	BY	RFD
05-28-03			01-17-91		
RELEASED TO PRODUCTION			DESCRIPTION		

SCALE: 1" = 1" OF SHEET 1 OF 1  
 DWG. NO. A0541936

SIGHTGLASS ASSEMBLY  
 ALL PUMP TANKS



## 6-6 Typical Piping Diagrams

### Typical Single Well Cooling Tower Water Pump Tank Piping System

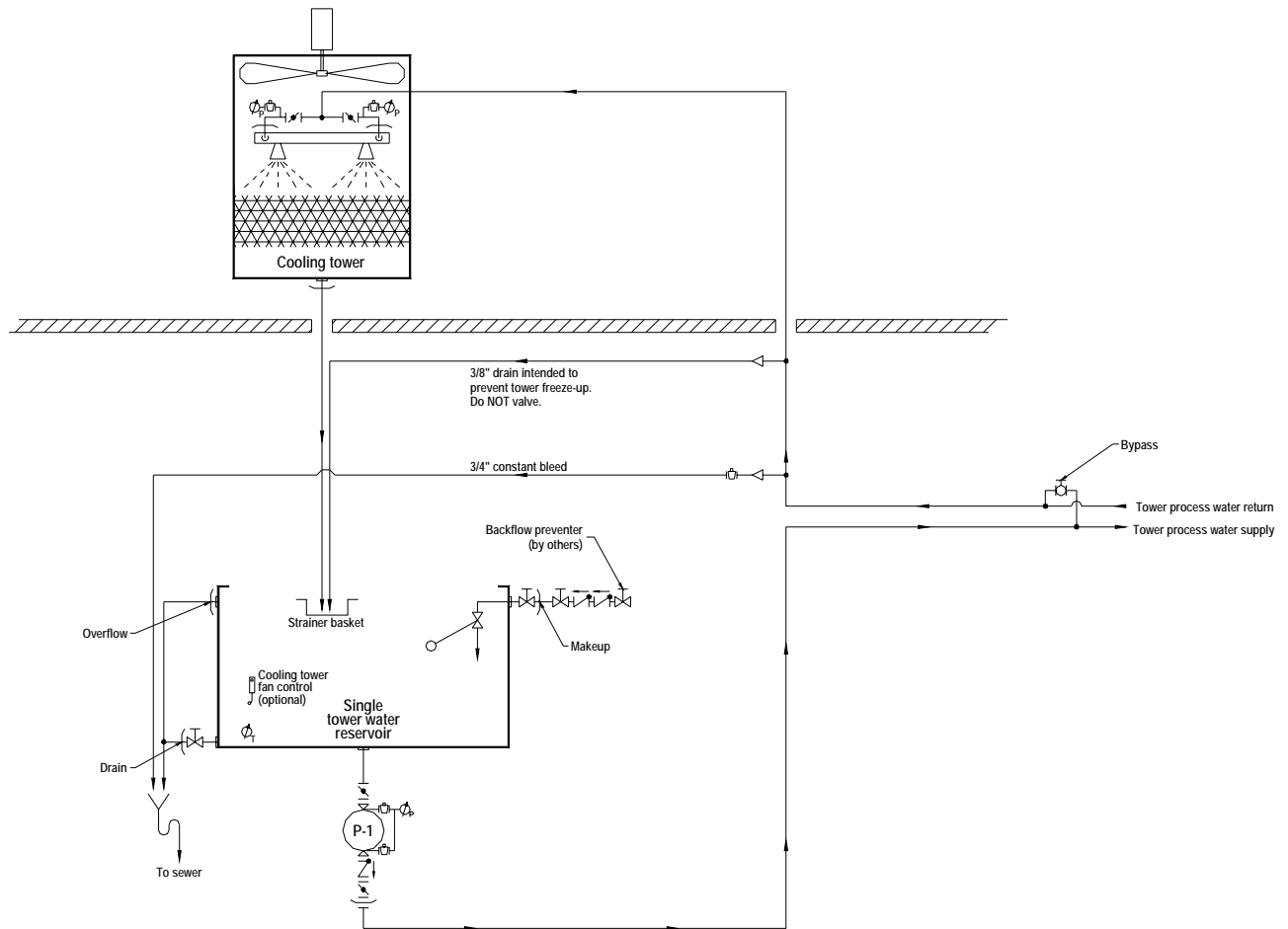

## Typical Dual Well Cooling Tower Pump Tank Piping System

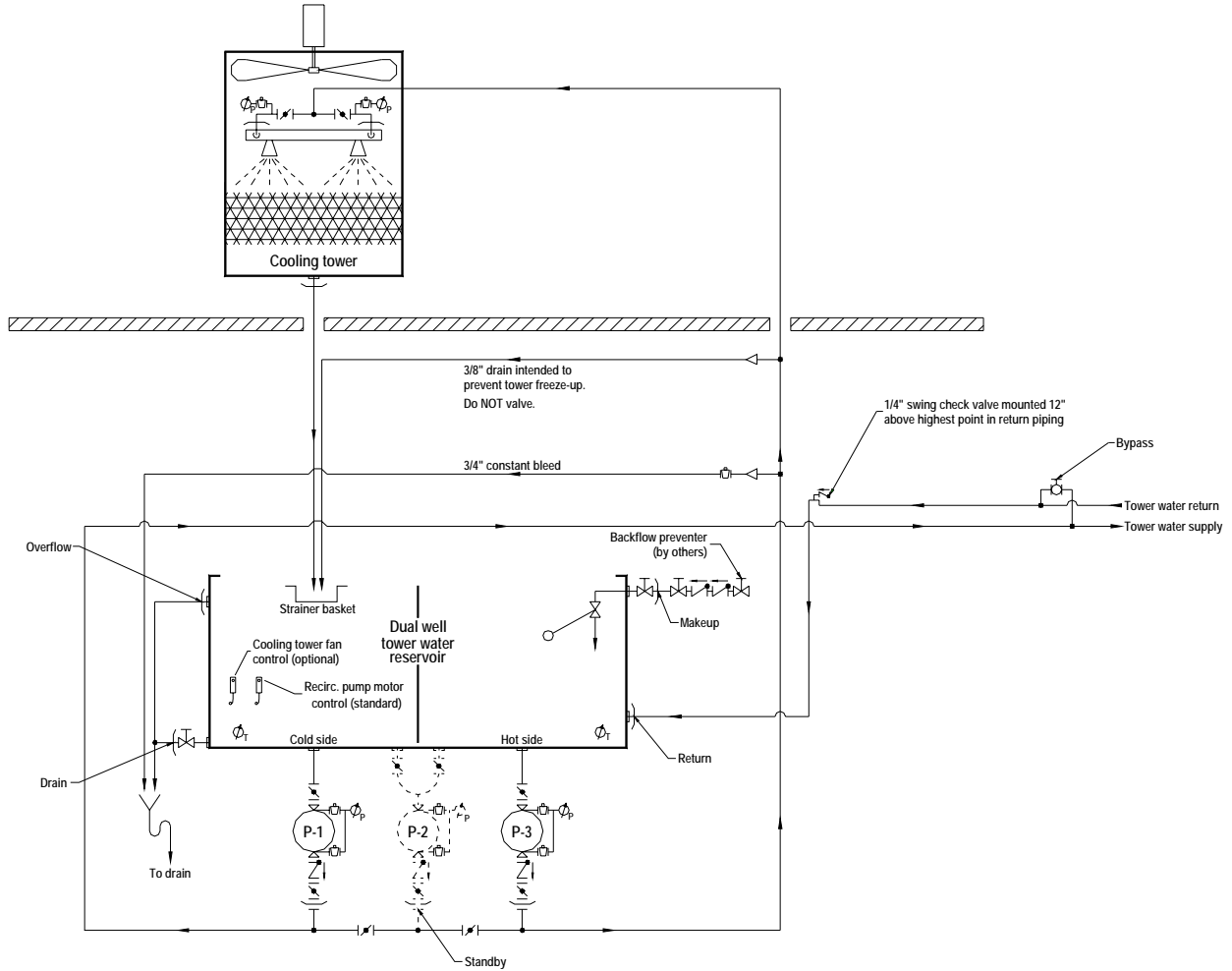

## Typical Single Well Chilled Water Pump Tank Piping System

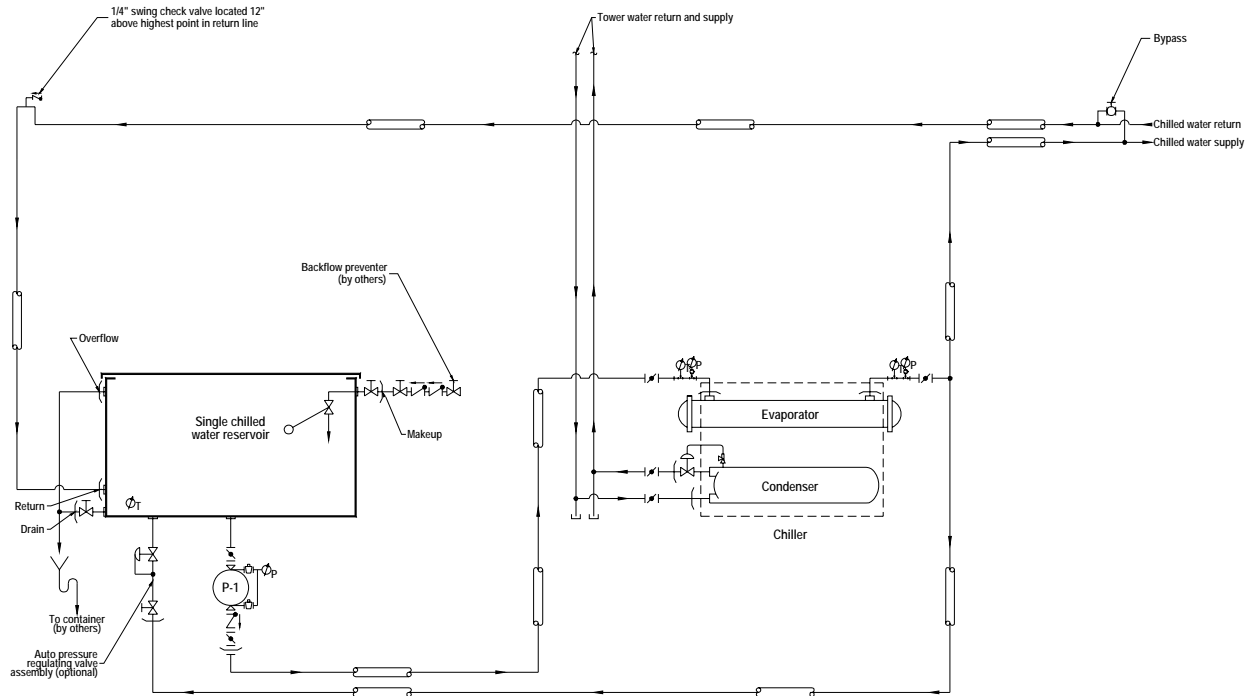

**Caution!** Do not connect city water makeup if glycol is used in the system

**Caution!** Do not connect to draw if glycol is used in the system. Pipe to catch drum or overflow tank.

## Typical Dual Well Chilled Water Pump Tank Piping System

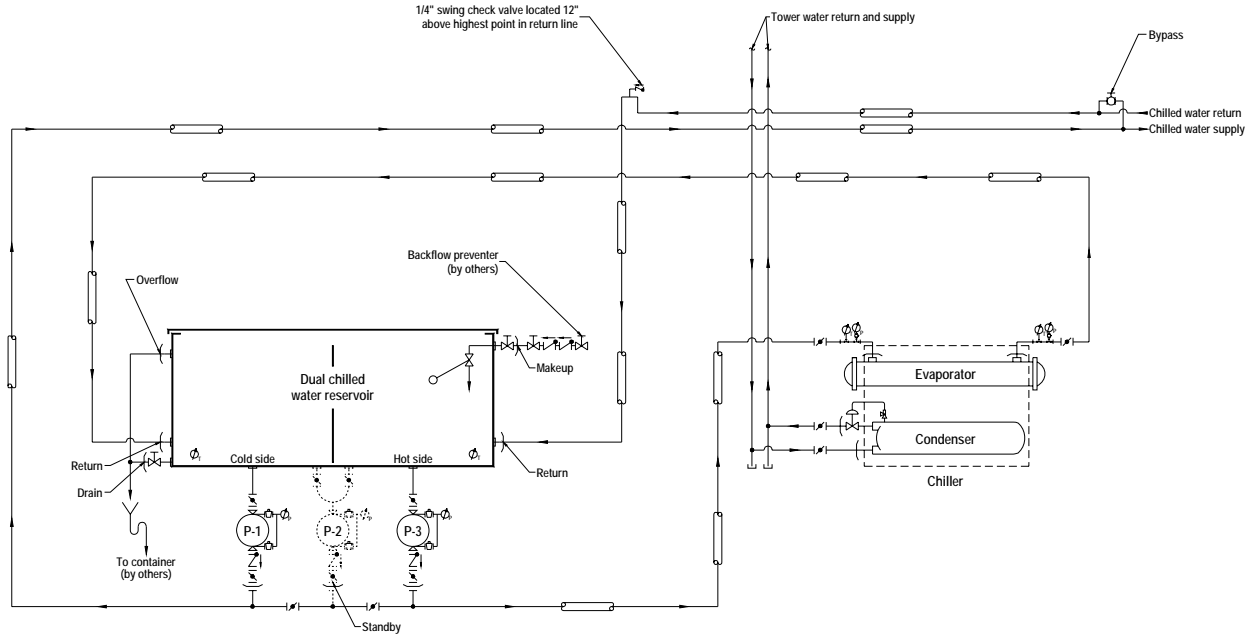

**Caution!** Do not connect city water makeup if glycol is used in the system

**Caution!** Do not connect to draw if glycol is used in the system. Pipe to catch drum or overflow tank.

## Free Manuals Download Website

<http://myh66.com>

<http://usermanuals.us>

<http://www.somanuals.com>

<http://www.4manuals.cc>

<http://www.manual-lib.com>

<http://www.404manual.com>

<http://www.luxmanual.com>

<http://aubethermostatmanual.com>

Golf course search by state

<http://golfingnear.com>

Email search by domain

<http://emailbydomain.com>

Auto manuals search

<http://auto.somanuals.com>

TV manuals search

<http://tv.somanuals.com>