



GP Series Portable Chillers

Part Number: 882.93092.01
Bulletin Number: SC2-620.4
Effective: 10/10/2011

Write Down Your Serial Numbers Here For Future Reference:

_____	_____
_____	_____
_____	_____

We are committed to a continuing program of product improvement.
Specifications, appearance, and dimensions described in this manual are subject to change without notice.

ECN No. _____
© Copyright 2012
All rights reserved.

Shipping Information

Unpacking and Inspection

You should inspect your equipment for possible shipping damage. Thoroughly check the equipment for any damage that might have occurred in transit, such as broken or loose wiring and components, loose hardware and mounting screws, etc.

In the Event of Shipping Damage

According to the contract terms and conditions of the Carrier, the responsibility of the Shipper ends at the time and place of shipment.

Notify the transportation company's local agent if you discover damage

Hold the damaged goods and packing material for the examining agent's inspection. **Do not return any goods before the transportation company's inspection and authorization.**

File a claim with the transportation company. Substantiate the claim by referring to the agent's report. A certified copy of our invoice is available upon request. The original Bill of Lading is attached to our original invoice. If the shipment was prepaid, write us for a receipted transportation bill.

Advise customer service regarding your wish for assistance and to obtain an RMA (return material authorization) number.

If the Shipment is Not Complete

Check the packing list as back-ordered items are noted on the packing list. In addition to the equipment itself, you should have:

- Bill of lading
- Packing list
- Operating and Installation packet
- Electrical schematic and panel layout drawings
- Component instruction manuals (if applicable)

Re-inspect the container and packing material to see if you missed any smaller items during unpacking.

If the Shipment is Not Correct

If the shipment is not what you ordered, **contact the parts and service department immediately** at (262) 641-8610. Have the order number and item number available.

Hold the items until you receive shipping instructions.

Returns

Do not return any damaged or incorrect items until you receive shipping instructions from the shipping department.

Table of Contents

CHAPTER 1: SAFETY	5
1-1 How to Use This Manual.....	5
<i>Safety Symbols Used in this Manual</i>	5
1-2 Warnings and Precautions.....	6
1-3 Responsibility.....	6
CHAPTER 2: FUNCTIONAL DESCRIPTION	7
2-1 Models Covered in This Manual.....	7
2-2 General Description.....	7
<i>Typical Applications</i>	7
<i>System Limitations</i>	7
<i>Chilled Water Circuit</i>	8
<i>Refrigeration Circuit</i>	9
2-3 Standard Features.....	10
<i>Mechanical Features</i>	10
<i>Electrical Features</i>	11
<i>Refrigeration Features</i>	11
<i>Controller Features</i>	12
<i>Other Features</i>	12
2-4 Safety Devices and Interlocks.....	12
<i>Crankcase Heater</i>	12
<i>High Pressure Cutout</i>	13
<i>Low Pressure Cutout (no switch but done through the transducer)</i>	13
<i>Flow Switch</i>	14
<i>Remote Start/Stop Interlock</i>	14
2-5 Optional Features.....	14
CHAPTER 3: INSTALLATION	16
3-1 Uncrating.....	16
3-2 Electrical Connections.....	16
3-3 Process Water Connections.....	17
3-4 Bypass Valve Considerations.....	17
3-5 Galvanic Corrosion Considerations.....	18
3-6 Water Treatment Considerations.....	18
3-7 Condenser Considerations.....	18
<i>Water-Cooled Chiller Condensers</i>	18
<i>Air-Cooled Chiller Condensers</i>	19
<i>Remote Air-Cooled Chiller Condensers</i>	20
3-8 Checking Motor Direction.....	27
<i>Three-Phase Compressors</i>	27
<i>Water Pumps</i>	27
<i>Condenser Fan</i>	27
3-9 Water Reservoir.....	28
3-10 Automatic Water Make-Up Option.....	31
3-11 Initial Start-Up.....	31
3-12 Finishing Setup: Setting Up Passwords.....	33
CHAPTER 4: OPERATION	35
4-1 Panel Buttons, Indicator Lights, and Switches.....	35
<i>Microprocessor Controller</i>	35
4-2 Initial Start-up.....	36
4-3 Status Screens.....	37

4-4	Access Levels	41
4-5	Controller Setpoints.....	41
4-6	Configuration Settings.....	45
4-7	Alarms	47
4-8	Optional Communications.....	47
CHAPTER 5: MAINTENANCE		48
5-1	Lubrication	48
5-2	Filter Cleaning.....	48
5-3	Maintaining the Condenser	48
	<i>Air- and Remote Air-Cooled Chillers</i>	<i>48</i>
	<i>Water-Cooled Chillers</i>	<i>48</i>
5-4	Maintaining the Evaporator.....	49
5-5	Evaporator Process Piping Y-Strainer	49
5-6	Preventative Maintenance Service	49
CHAPTER 6: TROUBLESHOOTING		50
6-1	Identifying the Cause of a Problem.....	50
	<i>Non-Controller Related Issues</i>	<i>55</i>
CHAPTER 7: APPENDIX.....		58
7-1	Returned Material Policy.....	58
	<i>Credit Returns</i>	<i>58</i>
7-2	Technical Assistance	58
	<i>Parts Department</i>	<i>58</i>
	<i>Service Department.....</i>	<i>59</i>
	<i>Sales Department.....</i>	<i>59</i>
	<i>Contract Department.....</i>	<i>59</i>
7-3	Specifications.....	60
	<i>Air-Cooled Portable Chillers</i>	<i>60</i>
	<i>Water-Cooled Portable Chillers.....</i>	<i>65</i>
7-4	Pump Curves, Flow, and Pressure Considerations	70
	<i>60 Hertz Pump Curves</i>	<i>70</i>
	<i>50 Hertz Pump Curves</i>	<i>72</i>
7-5	Remote Air-Cooled Chiller Configurations	75
7-6	Typical Ductwork for Air-Cooled Chillers	77
7-7	Piping Diagrams.....	79

Chapter 1: Safety

1-1 How to Use This Manual

Use this manual as a guide and reference for installing, operating, and maintaining your equipment. The purpose is to assist you in applying efficient, proven techniques that enhance equipment productivity.

This manual covers only light corrective maintenance. No other maintenance should be undertaken without first contacting a service engineer.

The Functional Description section outlines models covered, standard features, and optional features. Additional sections within the manual provide instructions for installation, pre-operational procedures, operation, preventive maintenance, and corrective maintenance.

The Installation chapter includes required data for receiving, unpacking, inspecting, and setup of the equipment. We can also provide the assistance of a factory-trained technician to help train your operator(s) for a nominal charge. This section includes instructions, checks, and adjustments that should be followed before commencing with operation of the equipment. These instructions are intended to supplement standard shop procedures performed at shift, daily, and weekly intervals.

The Operation chapter includes a description of electrical and mechanical controls, in addition to information for operating the equipment safely and efficiently.

The Maintenance chapter is intended to serve as a source of detailed assembly and disassembly instructions for those areas of the equipment requiring service. Preventive maintenance sections are included to ensure that your equipment provides excellent, long service.

The Troubleshooting chapter serves as a guide for identification of most common problems. Potential problems are listed, along with possible causes and related solutions.

The Appendix contains technical specifications, drawings, schematics, and parts lists. A spare parts list with part numbers specific to your machine is provided with your shipping paperwork package. Refer to this section for a listing of spare parts for purchase. Have your serial number and model number ready when ordering.

Safety Symbols Used in this Manual

The following safety alert symbols are used to alert you to potential personal injury hazards. Obey all safety messages that follow these symbols to avoid possible injury or death.

DANGER indicates an imminently hazardous situation which, if not avoided, will result in death or serious injury.

WARNING indicates a potentially hazardous situation or practice which, if not avoided, could result in death or serious injury.

CAUTION indicates a potentially hazardous situation or practice which, if not avoided, may result in minor or moderate injury or in property damage.

1-2 Warnings and Precautions

Our equipment is designed to provide safe and reliable operation when installed and operated within design specifications, following national and local safety codes.

To avoid possible personal injury or equipment damage when installing, operating, or maintaining this equipment, use good judgment and follow these safe practices:

- ✓ Follow all **SAFETY CODES**.
- ✓ Wear **SAFETY GLASSES** and **WORK GLOVES**.
- ✓ Disconnect and/or lock out power before servicing or maintaining the equipment.
- ✓ Use care when **LOADING, UNLOADING, RIGGING, or MOVING** this equipment.
- ✓ Operate this equipment within design specifications.
- ✓ **OPEN, TAG, and LOCK ALL DISCONNECTS** before working on equipment. You should remove the fuses and carry them with you.
- ✓ Make sure the equipment and components are properly **GROUNDED** before you switch on power.
- ✓ When welding or brazing in or around this equipment, make sure **VENTILATION** is **ADEQUATE**. **PROTECT** adjacent materials from flame or sparks by shielding with sheet metal. An approved **FIRE EXTINGUISHER** should be close at hand and ready for use if needed.
- ✓ Refrigeration systems can develop refrigerant pressures in excess of 500 psi (3,447.5 kPa/ 34.47 bars). **DO NOT CUT INTO THE REFRIGERATION SYSTEM. This must be performed by a qualified service technician only.**
- ✓ Do not restore power until you remove all tools, test equipment, etc., and the equipment and related components are fully reassembled.
- ✓ Only **PROPERLY TRAINED** personnel familiar with the information in this manual should work on this equipment.

We have long recognized the importance of safety and have designed and manufactured our equipment with operator safety as a prime consideration. We expect you, as a user, to abide by the foregoing recommendations in order to make operator safety a reality.

1-3 Responsibility

These machines are constructed for maximum operator safety when used under standard operating conditions and when recommended instructions are followed in the maintenance and operation of the machine.

All personnel engaged in the use of the machine should become familiar with its operation as described in this manual.

Proper operation of the machine promotes safety for the operator and all workers in its vicinity.

Each individual must take responsibility for observing the prescribed safety rules as outlined. All warning and danger signs must be observed and obeyed. All actual or potential danger areas must be reported to your immediate supervisor.

Chapter 2: Functional Description

2-1 Models Covered in This Manual

This manual provides operation, installation, and maintenance instructions for air-, water-and remote air-cooled portable chillers. Model numbers are listed on the serial tag. Make sure you know the model and serial number of your equipment before contacting the manufacturer for parts or service.

Our portable chiller models are designated by approximate output in kW of cooling (20, 30, 40, 50, through 210) and the cooling method used: -A for air-cooled, -W for water-cooled, and -R for remote-air cooled.

2-2 General Description

Our portable chillers are reliable, accurate, and easy to use process cooling units. They are available in air-, water-, and remote air-cooled designs in a range of sizes from 20 kW through 210 kW (5 through 60 tons of refrigeration). All are self-contained, fully portable and shipped ready to use. (Remote air-cooled chillers require field installation by qualified technicians.) In the standard configuration the chiller basically consists of a pump, tank, compressor, condenser, evaporator, and a control platform. All of these components, plus the other integral components to maintain the leaving fluid temperature, are described throughout this Chapter as well as Chapters 3 and 4.

Standard range of operation is 20°F to 80°F (-7°C to 27°C) for applications using a water/glycol mix and 45°F to 80°F (7° to 27°C) for water only applications.

Typical Applications

This series of portable chillers can be used in any application that needs a constant source of cool process water. Typical applications include, but are not limited to, the following:

- Injection molding
- Blow molding
- Extrusion
- Thermoforming
- Machine tool
- Metal plating
- Thermal spray
- After-coolers (air compressors, dryers, etc.)
- Laser
- Printing (offset, gravure, digita)

System Limitations

These packaged chillers should be chosen using the following criteria:

Process heat load – Choose the size of the chiller so that rated capacity is no greater than 10% more than the process heat load.

Process Fluid Temperature – The standard range for the leaving fluid temperature for this series of packaged chillers is 20°F to 80°F (-6.7°C to 26.7°C). When the process requires fluid temperatures below 45°F (27.2°C) it is imperative that the process fluid is a mix of an industrial grade ethylene or propylene glycol and water to the proper percentage (by volume) to protect the system. See Chapter 3 for a further discussion regarding the use of glycol within the system for these applications.

WARNING! - ACS Group does not warrant the freeze up of the evaporator under any circumstances.

Chilled Water Circuit

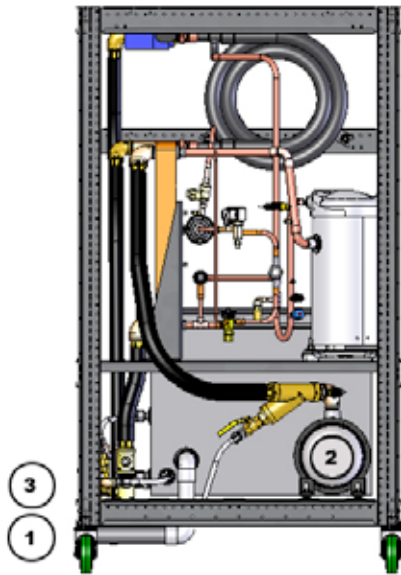

Cooling water “To Process” and “From Process” connections are made at the female NPT couplings provided outside the unit.

- ① Warm coolant (water and glycol mixture) returns from the process and goes into the reservoir tank.
- ② The coolant is then pumped through the evaporator where it is cooled.
- ③ The coolant flows to the process and returns to repeat the cycle.

A process water bypass valve located between the supply line and reservoir tank (single pump models only) allows minimal flow through the unit during the intermittent fluctuating flow conditions. It is not intended to provide continuous full bypass flow.

This minimal flow allows the flow switch to make when the process flow is stopped. If the flow switch is not made the controller shuts down the compressor to prevent freezing up the evaporator.

Refrigeration Circuit

Air-, water-, and remote air-cooled refrigerant condensing differ only in the way the compressed gas is condensed to a liquid. Shown below is a water cooled version.

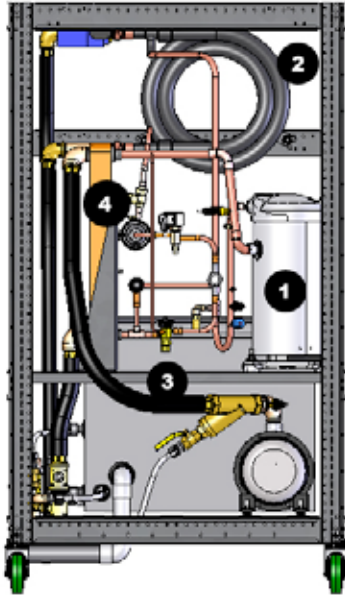

- 1 The refrigerant is compressed in the compressor and flows through the discharge line as a gas to the condenser.
- 2 There it gives up its heat as it condenses to a liquid in the condenser.
- 3 Liquid refrigerant from the condenser heat exchanger flowing in the liquid line passes through a shut-off valve into a filter/dryer that removes moisture and other contaminants. After the filter/dryer the refrigerant passes through a solenoid valve to prevent liquid migration when the compressor is off. A refrigerant sight glass is provided to view the flow of liquid refrigerant, and to view if the system is free of moisture. The refrigerant then passes through the thermal expansion valve, which allows the refrigerant to expand (boil off) and cool (remove the heat from) the fluid inside of the evaporator.
- 4 From the evaporator the refrigerant gas flows through the suction line back into the compressor.

A modulating electronic hot gas bypass valve is used to control cooling capacity during intermittent or partial load conditions. This feature contributes substantially to chiller longevity by eliminating excessive cycling of the compressor and providing close temperature control.

System Control

Putting this all together, the controller maintains the desired leaving fluid temperature using multiple inputs to determine if, when and for how long the compressor(s) are on, and if, when, the percent open and for how long the modeling hot gas bypass valve is on.

Once the unit's power is enabled and the controller is turned on (see Chapter 4 for more details on the operation of the controller) it verifies there is sufficient fluid level in the tank (if present). If there is not enough fluid in the tank the controller will warn the user, or fill the tank with water from a connected source if equipped with the optional automatic water makeup valve. See Chapter 3 for more information regarding the initial setup and startup of the unit.

Once the tank level is satisfied and the start button is pressed, the process pump turns on and provides flow to the process. The controller verifies the flow through the electronic flow switch. If the flow is not established within 10 seconds the controller will alarm and disable the refrigeration circuit. Upon flow verification the controller uses the leaving fluid temperature and the setpoint temperature to determine the operation of the compressor(s). When the leaving fluid temperature is greater than the setpoint plus the "compressor on

differential” value the controller will enable the compressor; if equipped with two compressors the controller will enable the one with the least amount of hours. The second compressor will be enabled if the leaving fluid temperature remains above the setpoint plus the “compressor on differential” value for more than 60 seconds.

The hot gas valve is designed to trim the load of one compressor and will modulate in order to meet the desired leaving fluid setpoint via a PID algorithm. After the compressor starts, the hot gas valve is allowed to modulate. The compressor will shut off if the leaving fluid temperature drops below the “compressor off differential” and the hot gas valve is at 100% for the “compressor off delay” time. The hot gas will reset to 0% when the compressor is off. There is a “compressor anticyle” timer that will delay the time between compressor starts to prevent short cycling of the compressor. This is a start to start timer set at 5 minutes. For example, if the compressor has been running for 5 minutes and shuts off, then the compressor can start immediately if the demand is there. If it has only been running for 2 minutes, then it would not be able to start again for 3 minutes.

For a unit with two compressors, the second compressor or lag compressor starts when the lead compressor is on, the hot gas is at 0%, and the leaving fluid temperature is above the setpoint plus the “compressor on differential”. There is also an adjustable “lag compressor on delay” timer. Before starting either compressor, the compressor with the least amount of runtime hours is considered the lead compressor and the first to start. When both compressors are running, the compressor with the most hours is considered the lead compressor and is the first to stop. The lead compressor will shut off if the leaving fluid temperature drops below the “compressor off differential” and the hot gas valve is at 100% for the “lead compressor off delay” time. The compressor anti-cycle timers are active with the two compressor units.

There will be two PID controls running simultaneously for determining the position of the hot gas valve. One PID output will be based on leaving fluid temperature and the other based on a minimum saturated suction temperature for freeze protection. The hot gas valve position will be determined by which output is greater. If it is controlling to the saturated suction temperature to prevent freezing, a warning will display on the screen that the hot gas is in this mode. Once the control goes back to setpoint control, the warning will disappear. The saturated suction temperature is calculated from the suction pressure and the type of refrigerant.

The discharge pressure is controlled using an analog output signal to drive a fan for air-cooled units or a water regulating valve for water-cooled units. The output signal is determined from a PID algorithm using a discharge pressure transducer as the process variable. The VFD or water regulating valve is controlled from the analog output to an adjustable discharge pressure setpoint. The analog output starts at the initial “discharge pressure start” % for a given time delay (discharge pressure hold). After the time delay, it will control to the discharge pressure setpoint via the PID control. There is also a setting to control the discharge pressure to the most efficient value.

2-3 Standard Features

Mechanical Features

Compressor – Hermetic scroll compressors.

Evaporator – Stainless steel copper brazed plate evaporators.

Air-Cooled Condenser – Aluminum fin/ tube with washable filters, *packaged units only*. Variable speed fan control standard for all remote air cooled condensers and GPAC70 through 210. Optional on GPAC20 through 50.

Water-Cooled Condenser – Tube-in-tube condensers (GPWC20 – GPWC50), Shell-and-tube condensers (GPWC70 – GPWC210). All come with electronic cooling water regulating valves.

Remote Air-Cooled Condenser– Aluminum fin/tube with low ambient control down to –20°F (-29°C) via variable-speed fan(s).

Reservoir – GP20 and GP30 models use a 20 gallon (75 liter) polyethylene tank, GP40 and GP50 models use a 40 gallon (150 liter) polyethylene tank, GP70 thru GP105 models use a 70 gallon (265 liter) polyethylene tank, GP140 thru GP210 models use a 140 gallon (530 liter) polyethylene tank. 304SS is available as an option for all sizes.

Piping – Non-ferrous chilled water piping

Pump – ODP motors (TEFC Optional)—horizontally mounted stamped stainless steel construction.

Other Mechanical Features

- Low process water thermal flow switch
- NEMA-rated fan motor(s) on air-cooled models
- Galvanized structural steel frame, polyester powder coat painted cabinetry
- Internal process water bypass valve for system protection only
- Fully insulated refrigeration and process water piping
- 20 mesh Y strainer on process water piping into the evaporator
- Tank level indication via operator interface
- Pump pressure indication via operator interface

Electrical Features

- Fully accessible NEMA 4/12-style electrical control enclosure
- Single-point power and ground connection
- Non-fused disconnect switch, lockable
- Branch circuit protection
- 208-230/3/60, 460/3/60, 575/3/60 volt; 400/3/50 volt

Refrigeration Features

- HFC-410a refrigerant
- Electronic modulating hot gas bypass capacity control
- High refrigerant pressure cutout switch (manual reset)
- Suction and discharge pressure transducers.
- High refrigerant pressure spring actuated relief valve

- Multiple refrigeration access ports
- Liquid line shut-off ball valves
- Filter-dryer
- Sight glass
- Externally equalized thermal expansion valve
- Liquid line solenoid
- Compressor crankcase heater

Controller Features

- Off-the-shelf microprocessor-based PID controller with To Process, From Process and Set Point readout
- Time delay for proof of water flow/pressure (models w/pump only)
- Low refrigerant pressure time delay for low ambient start-up on remote air-cooled and air-cooled chillers with the variable-speed fan option.
- 8 line x 22 character display with status, alarm, and service screens
- Display has magnetic back and can be mounted anywhere.

Other Features

- One year labor warranty and one year compressor warranty
- Two year parts warranty
- Three year limited controller warranty

2-4 Safety Devices and Interlocks

Caution! *Protect the system from freezing with inhibited industrial grade glycol 20°F below the leaving water temperature set point. Condensation may form inside the pump tank and dilute the mixture, therefore the freezing point should be verified periodically. See Figure 6 on page 18 for the correct mixture.*

Crankcase Heater

All of the chillers are equipped with a compressor crankcase heater. It is wired through the control transformer that operates continuously whenever power is applied to the chiller, and the compressors are off.

Caution! *Energize the crankcase heater for at least 24 hours before initial startup to drive dissolved refrigerant from the compressor oil. Failure to do so will damage the compressor. If unit is mounted outdoors, power to the unit (and the main power switch) must remain on 24 hours per day, 7 days per week to prevent liquid migration to the compressor.*

High Pressure Cutout

This electro-mechanical cutout device opens the compressor control circuit if the refrigeration system compressor discharge pressure exceeds 575 psig.

Note: *The high-pressure cutout is a manual reset device typically mounted on the compressor discharge line inside the mechanical cabinet. Call a refrigeration service technician to analyze the problem and reset the control.*

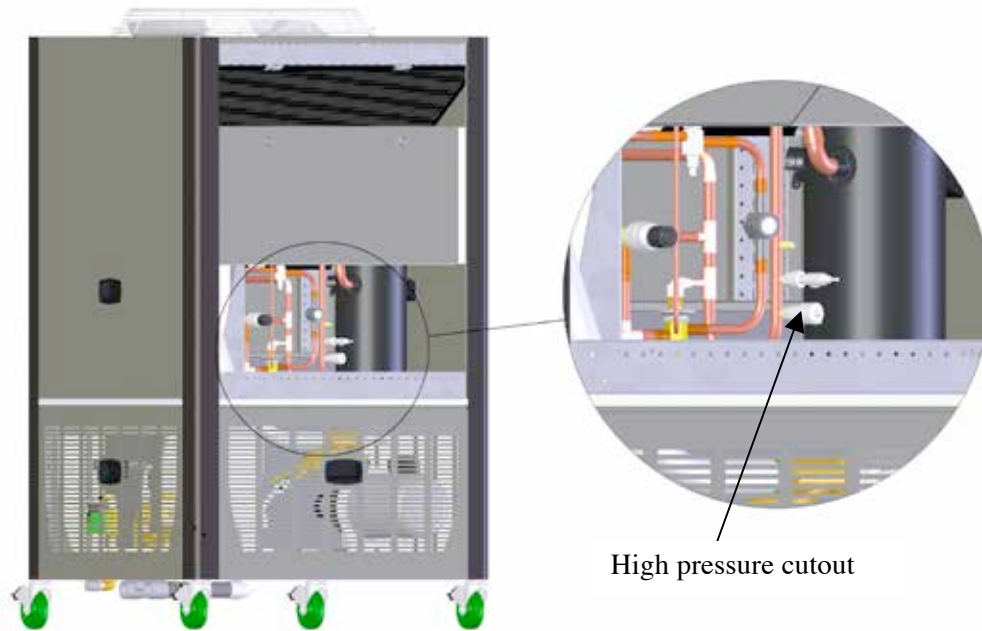

Typical GPAC-20

Low Pressure Cutout (no switch but done through the transducer)

There are two pressure transducers in the refrigeration piping – one on the suction line before the compressor and one on the discharge line after the compressor. Within the program there are four settings that warn and fault based on these two pressure transducers. The low suction pressure warning and fault are calculated based on the Freeze Point value entered into the controller. The low discharge warning is set for 200 psig (1,379 kPa), and the compressor will fault at 180 psig (1,241 kPa). To prevent nuisance tripping there are delays built in to the program.

Note: *Call a refrigeration service technician to analyze the problem to prevent recurring low pressure faults.*

Flow Switch

The thermal dispersion flow switch cutout device, mounted in the process piping, shuts down the chiller if it senses that the water/glycol flow rate through the evaporator has dropped below an acceptable level. The flow switch opens the control circuit and shuts down the pump and the chiller.

Remote Start/Stop Interlock

An additional contact is provided to allow the remote starting or stopping of the chiller. To use this feature install a switch or dry contact interlock connected in series between terminals 4 and 23. Refer to the electrical schematic supplied in the control enclosure. Once the wiring is complete the controller will need to be reconfigured in the supervisor settings.

2-5 Optional Features

Options marked with “*” indicate options that can be factory installed or retrofitted in the field.

Automatic Water Make-Up*. Not available on chillers less reservoir tank. This option includes an electric water solenoid valve, and the necessary internal piping to connect the chiller to a make-up water source. The controller uses the standard tank level pressure transducer to determine when to fill the tank. See Appendix for typical piping diagrams.

Caution! *Customer piping must provide backflow protection and venting of tank to atmosphere to prevent over-pressurization of the reservoir tank (not needed for open tank). See Section 7-7 for flow schematics.*

Process Water Side-stream Filter*. Not available on chillers less pump and reservoir tank. This option includes a 50 micron filter, flow indicator, ball valve for throttling water flow, and the necessary piping to provide constant filtering of the process water at about one gallon per minute (1 gpm/3.8lpm).

General Fault Indicator Audible/Visual Alarm*. This option includes a 100 dB audible alarm horn/ visual alarm strobe and silence button with provisions for customer wiring indication interlock. The alarm signals anytime that a fault is recognized during the operation of the chiller.

Communications Options*. This option provides the capability for the unit’s controller to communicate with an external device using a variety of serial communication protocols. Currently the unit can communicate over RS-485 Modbus RTU, BACNet, LONWorks, Ethernet Modbus.

High Pressure Fans. Provides either 0.3” WC (75 Pa) or 1.0”WC (250 Pa) of external static pressure on fan discharge. High-pressure fans are necessary and must be included in chiller installations where exiting air exhausts through ductwork.

The 0.3” WC (75 Pa) static fan can be retrofitted without sheet metal modification, but will require changing out fan housing, fan blades, fan motors and electrical components.

Variable Speed Fan – GPAC20-50. Reduces the speed of the fan based on refrigerant pressure and system load, allowing the chiller to operate in ambient temperatures below 75°F (24°C). This option will also reduce fan noise in lower ambient temperatures and low loads.

Stainless Steel Reservoir. Manufactured from 304 stainless steel.

Mounting Features.

Mounting rails with feet – GP20-GP105 indoor units. Standard on GP140-GP210 and all outdoor packaged units.

Optional Operating Voltages. 208-230/3/60, 460/3/60, 575/3/60, and 400/3/50 volt available

UL/cUL Labeled Electrical Subpanel. This option provides for the subpanel to be listed with Underwriters Laboratory, with UL-related benefits and features. Sub-panels marked by the UL/cUL sticker are accepted within Canada.

Optional Pumps. Pump options are available for greater pressure and flow rates. A recirculation pump is required whenever process water flow is less than 1.2 gpm per ton or greater than 4.8 gpm per ton. See Figure 1 below for optional pump amperages.

Figure 1: Optional Pump Amperages

Voltage	Construction	HP (kW)	Full Load Amps
460/3/60	SS	1 (0.8)	1.7
		1.5 (1.1)	2.3
		2 (1.5)	4.0
		3 (2.2)	4.2
		5 (3.7)	8.2
		7.5 (5.6)	10.3
		10 (7.5)	12.0
		15 (11)	20.0
		30 (22)	32.0

Chapter 3: Installation

3-1 Uncrating

All models are shipped mounted on a skid, enclosed in a plastic wrapper, and open-crated on all four sides and top.

1. Pry the crating away from the skid.
2. Use a pry bar to remove the blocks securing the unit to the skid.
3. Lift unit from sides, inserting forklift under the base. The forks must be equidistant from the centerline of the unit and the unit must be balanced on the forks. Lift slowly and only high enough to clear the skid. Use a pry bar if necessary to carefully remove the skid from the unit.
4. Lower slowly. The unit should land on its casters or rails and can then be moved into position.
5. Retain the crating material for reshipping the chiller in case hidden shipping damage is found.

3-2 Electrical Connections

Supply electricity of the voltage, phase, and cycle listed on the serial tag. Total running amps are also found in the specification tables on pages in the Appendix.

Bring properly sized power leads and ground from a fused disconnect (installed by your electrician) to the unit. Use dual-element fuses in the disconnect switch, sized according to the National Electrical Code recommendations. Make sure all electrical connections are tight.

Important!

Refer to your local electrical requirements for proper feeder conductor and supply disconnecting sizing. For instance, in the United States refer to National Electric Code (NEC) Article 430-24 through 430-26, Table 310.15(B)(2)(a)

Note: *For all chillers manufactured with Variable Frequency Drives the voltage may vary up to 10% from the converter nominal voltage. However, the phase-to-phase input voltage imbalance must not exceed 3%. If the input voltage does have an imbalance from phase to phase greater than 3% then a line reactor must be installed to prevent faults within the VFD.*

For remote condenser units, the maximum recommended motor cable length between the VFD and the motor without output chokes is 30 m (100 ft). With output chokes the motor cable length may be extended to 65 m (195 ft).

3-3 Process Water Connections

All of our portable chillers have two chilled water connections. The chilled water supply, labeled “To Process” is the outlet for the chilled water leading to the process being cooled. The chilled water return, labeled “From Process” is the inlet leading from the process back into the chiller to be cooled and re-circulated.

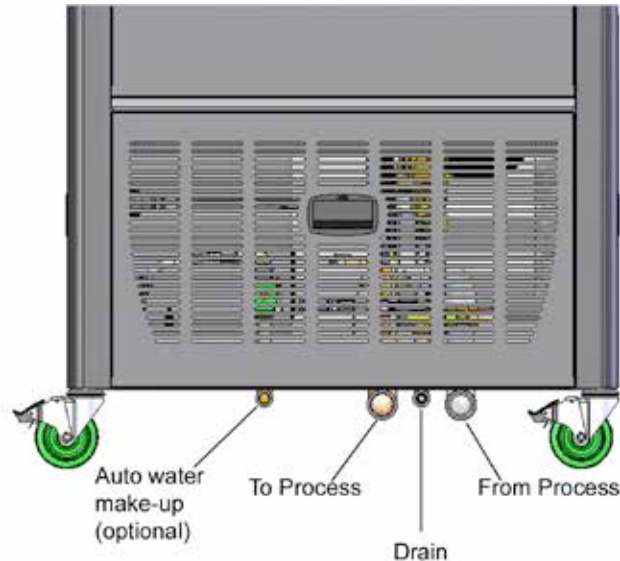

Figure 2: Typical GP20-50 Air Cooled Process Piping Connections

All external chilled water connections should be run full size to the process. Flow and pressure information is available in the Appendix. The largest possible openings and passages should be provided for the flow of chilled water through platens, dies, molds, or other pieces of equipment. Flow control valves are not supplied, but should be added to the system to adjust flow and pressure to the process and to isolate the chiller from the process if necessary.

Note: *Be sure to reduce external pressure drop as much as possible by generously sizing piping and tooling water passageways.*

3-4 Bypass Valve Considerations

Our portable chillers have an internal manual bypass valve. If the flow is stopped to the process while the chiller is running, the factory-set bypass valve allows a small amount of water to flow through the chiller. This action allows the chiller to keep functioning while the flow is stopped to process. The bypass valve is not intended to provide continuous full bypass flow.

Caution! *Do not attempt to adjust or otherwise tamper with the internal bypass. Your warranty will be voided.*

3-5 Galvanic Corrosion Considerations

The materials used in the water circuit piping of these chillers are non-ferrous and react electro-chemically with ferrous metallic materials. Some water has dissolved minerals that greatly accelerate the reaction between dissimilar metals.

PVC or non-ferrous piping is recommended to reduce galvanic action. If iron piping must be used, use dielectric unions at the chiller, and water treatment is required.

Note: *The use of galvanized piping is discouraged because the rough inside surface promotes debris to stick and eventually block the flow of the process fluid..*

3-6 Water Treatment Considerations

Water treatment is an integral part of the system. In some locations, water may cause large deposits of scale, erosion, algae, and/or corrosion.

Note: *The use of poor quality water may result in inefficient operation, heat exchanger damage, and pump seal damage. Consult a qualified water treatment specialist to determine what type of treatment is needed.*

3-7 Condenser Considerations

Water-Cooled Chiller Condensers

Water-cooled portable chillers can use city water or tower water as a cooling medium. Make sure that all external piping and connections supplying and discharging water to and from the condenser are full size.

You will make two connections to the water-cooled condenser:

Condenser Water In. The condenser water supply is labeled “Condenser Water In.” It is the inlet for city or tower water. For the GPWC20-50, this connection is located near the bottom of the chiller. For all other sizes this connection is located near the top of the chiller.

Make sure that water is supplied at a maximum temperature of 85°F (29°C) and a minimum pressure of 25 psi.

Caution! *The electronic water-regulating valves pressure setpoint is set at the factory. Only a qualified refrigeration technician should adjust the pressure setting. Please contact our service group at 800-423-3183 to schedule an appointment.*

Normal HFC-410a refrigerant condensing pressure is 342 psi (2,360 kPa), with 85°F (27°C) water at 25 psi entering condenser water pressure

Condenser Water Out. Condenser water return is labeled “Condenser Water Out.” It is the outlet for water after it has passed through the condenser. For the GPWC20-50, this connection is located near the bottom of the chiller. For all other sizes this connection is located near the top of the chiller.

It is connected to the tower water return line or to a sewer or other approved discharge receiver. A water-regulating valve is a standard feature in the condenser water out line.

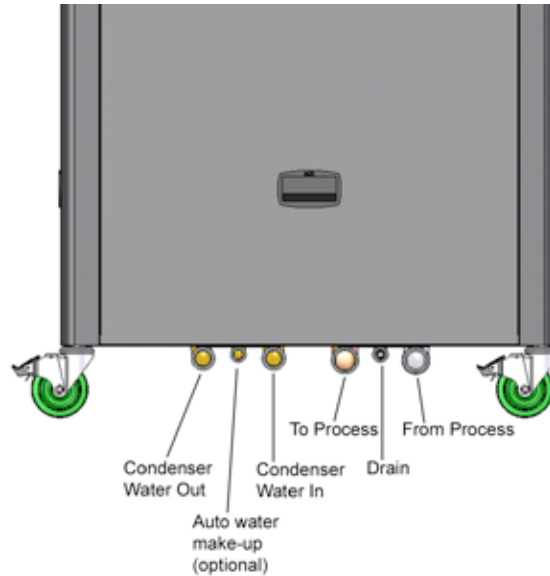

Figure 3: Typical GP20-50 Water Cooled Condenser Connections

Air-Cooled Chiller Condensers

Air-cooled chillers use the surrounding air to cool the condenser. Install the chiller in an area where there is free passage of air for condensing and provisions for removal of heated air from the area. Do not locate air-cooled chillers in locations where steam, hot air, or fume exhausts can be drawn into the chiller.

Caution! *Clean air-cooled condensers and filters frequently. Failure to do so results in reduced capacity, increased operating costs, and possible failure of the equipment. Cleaning instructions can be found in the Maintenance chapter of this manual*

Normal maximum refrigerant condensing pressure with 95°F (35°C) air entering the condenser is 420 psi (2896 kPa).

Condensing Air Temperature. Our air-cooled portable chillers are designed to operate at a minimum condenser entering air temperature of approximately 75°F (24°C). Operation of the equipment at a lower condenser entering air temperature can cause the chiller to malfunction. For entering air temperatures below 75°F (24°C), an optional fan motor speed control is available. We recommend maintaining a minimum 75°F (24°C) ambient temperature.

Note: *For all chillers manufactured with Variable Frequency Drives the voltage may vary up to 10% from the converter nominal voltage. However, the phase-to-phase input voltage imbalance must not exceed 3%. If the input voltage does have an imbalance from phase to phase greater than 3% then a line reactor must be installed to prevent faults within the VFD.*

For remote condenser units, the maximum recommended motor cable length between the VFD and the motor without output chokes is 30 m (100 ft). With output chokes the motor cable length may be extended to 65 m (195 ft).

Remote Air-Cooled Chiller Condensers

Remote air-cooled portable chillers are shipped with nitrogen holding charge and a full charge of oil (excluding the amount needed for field piping). The remote air condenser is shipped with a dry nitrogen charge. Verify that the holding charge has not been lost prior to installation. If there is no pressure, leak test the unit and repair before installing the interconnecting refrigerant piping. Read this entire section before installation.

Note: *Piping should be hard/drawn type “L” or type “K” refrigerant grade copper tubing only. Proper sizing and installation has a significant effect on system performance, reliability, and safety.*

Warning! *The copper tubing and fittings used must have a minimum burst pressure of 1,950 psi.*

Interconnecting Refrigerant Piping. The chiller and condenser refrigerant lines are terminated with a cap and brazed closed. Use a tube cutter to remove caps.

Caution! *Do not use a saw to remove the end caps because this will allow copper chips to contaminate the system.*

A certified refrigeration contractor needs only to install the interconnecting refrigerant piping between the chiller and the outdoor air-cooled condenser. This piping must be properly sized, type “L” or type “K” refrigerant grade tubing, high temperature brazed. **Install a customer supplied 650 psi approved refrigerant relief valve in the discharge line at the condenser, following all applicable codes.**

Flow dry nitrogen through the system when brazing copper joints to prevent carbon/scale formation; which causes contamination. Isolate the refrigerant lines from the building, preventing transfer of line vibration to the structure. Do not secure the lines rigidly.

Leak check and evacuate the system down to 400 microns. A decay of 50 microns after one hour is acceptable.

Warning! *To prevent injury or death due to explosion and/or inhalation of hydrogen-fluoride gas, purge system thoroughly while brazing refrigerant piping connections. Use a pressure regulator in the line between the unit and the high-pressure nitrogen cylinder to avoid over-pressurization and possible explosion.*

System Configuration. The system can be configured in any of the arrangements shown on page 75 of the Appendix. The configuration and distance between the chiller and the condenser affects pipe size, refrigerant charge, oil return, and oil charge. Therefore there are limitations that must be adhered to for reliable and optimal operation.

- Leaving water temperature affects discharge line size. Be sure to inform the installing contractor of the leaving water temperature range in which the chiller will be operating
- The total distance between the chiller and condenser must not exceed 200 feet or 300 equivalent pipe feet
- Discharge line risers cannot exceed an elevation difference greater than 100 feet without a 2% efficiency decrease.
- Refer to page 75 of the Appendix for the location of traps.
- Refrigeration lines must not be crossed, i.e., chiller liquid lines are to be piped to condenser liquid lines.

Sizing Refrigerant Lines. To determine field installed liquid and discharge line sizes, first establish the equivalent length of pipe for each line, valve, and elbow. Chiller capacity and leaving water temperature range is also required. See Figure 4 on page 21 for lengths of refrigerant valves and fittings.

Liquid Line Sizing. The liquid line should be sized as small as possible while maintaining acceptable pressure drop to minimize the refrigerant charge. Liquid line risers must not exceed 15 feet from the base of the air-cooled condenser. Horizontal runs do not require a pitch. Insulation is not required unless the line is installed in a high ambient area, i.e., boiler room or on a roof. Install a liquid line-charging valve to facilitate refrigerant charging. See Figure 5 on page 21 for sizing information. See Figure 7 on page 25 for charge determination.

Discharge Line Sizing. Discharge line sizing is based on the velocity required for sufficient oil return back to the compressor. See Figure 4: Equivalent Length in Feet for Valves and Fittings on page 24 for discharge line sizing.

Note: *For horizontal runs, the discharge line should be pitched downward, in the direction of flow, at a rate of 1/2" for every 10 feet. This will allow oil to flow towards the condenser.*

Figure 4: Equivalent Length in Feet for Valves and Fittings

Line Size OD (inches)	Angle Valve	Short Radius EL	Long Radius EL
3/8	24	4	2.8
1/2	24	4.7	3.2
5/8	25	5.7	3.9
3/4	25	6.5	4.5
7/8	28	7.8	5.3
1-1/8	29	2.7	1.9
1-3/8	33	3.2	2.2
1-5/8	34	3.8	2.6
2-1/8	39	5.2	3.4
2-5/8	44	6.5	4.2

Figure 5: Liquid Line Sizing

GPRC-20				
Total Equiv. Length (Ft)	Liquid Line Size (OD")			
	Horizontal or Downflow	Upflow 1-5 Ft	Upflow 6-10 Ft	Upflow 11-15 Ft
25	1/2	1/2	1/2	1/2
50	1/2	1/2	1/2	1/2
75	1/2	1/2	1/2	1/2
100	1/2	1/2	1/2	5/8
125	1/2	1/2	1/2	5/8
150	1/2	1/2	5/8	5/8
175	1/2	5/8	5/8	5/8
200	1/2	5/8	5/8	5/8
225	1/2	5/8	5/8	5/8
250	5/8	5/8	5/8	5/8
275	5/8	5/8	5/8	5/8
300	5/8	5/8	5/8	5/8

GPRC-30				
Total Equiv. Length (Ft)	Liquid Line Size (OD")			
	Horizontal or Downflow	Upflow 1-5 Ft	Upflow 6-10 Ft	Upflow 11-15 Ft
25	5/8	5/8	5/8	5/8
50	5/8	5/8	5/8	5/8
75	5/8	5/8	5/8	5/8
100	5/8	5/8	5/8	5/8
125	5/8	5/8	5/8	5/8
150	5/8	5/8	5/8	5/8
175	5/8	5/8	5/8	3/4
200	5/8	5/8	5/8	3/4
225	5/8	5/8	5/8	3/4
250	5/8	5/8	3/4	3/4
275	5/8	5/8	3/4	3/4
300	5/8	5/8	3/4	3/4

GPRC-40				
Total Equiv. Length (Ft)	Liquid Line Size (OD")			
	Horizontal or Downflow	Upflow 1-5 Ft	Upflow 6-10 Ft	Upflow 11-15 Ft
25	5/8	5/8	5/8	3/4
50	5/8	5/8	3/4	3/4
75	5/8	5/8	3/4	3/4
100	5/8	3/4	3/4	3/4
125	3/4	3/4	3/4	7/8
150	3/4	3/4	3/4	7/8
175	3/4	3/4	3/4	7/8
200	3/4	3/4	3/4	7/8
225	3/4	3/4	7/8	7/8
250	3/4	3/4	7/8	7/8
275	3/4	3/4	7/8	7/8
300	3/4	3/4	7/8	7/8

GPRC-50				
Total Equiv. Length (Ft)	Liquid Line Size (OD")			
	Horizontal or Downflow	Upflow 1-5 Ft	Upflow 6-10 Ft	Upflow 11-15 Ft
25	7/8	7/8	7/8	7/8
50	7/8	7/8	7/8	7/8
75	7/8	7/8	7/8	7/8
100	7/8	7/8	7/8	7/8
125	7/8	7/8	7/8	7/8
150	7/8	7/8	7/8	7/8
175	7/8	7/8	7/8	7/8
200	7/8	7/8	7/8	7/8
225	7/8	7/8	7/8	7/8
250	7/8	7/8	7/8	7/8
275	7/8	7/8	7/8	1-1/8
300	7/8	7/8	7/8	1-1/8

GPRC-70				
Total Equiv. Length (Ft)	Liquid Line Size (OD")			
	Horizontal or Downflow	Upflow 1-5 Ft	Upflow 6-10 Ft	Upflow 11-15 Ft
25	7/8	7/8	7/8	7/8
50	7/8	7/8	7/8	7/8
75	7/8	7/8	7/8	7/8
100	7/8	7/8	7/8	7/8
125	7/8	7/8	7/8	7/8
150	7/8	7/8	7/8	1-1/8
175	7/8	7/8	7/8	1-1/8
200	7/8	7/8	1-1/8	1-1/8
225	7/8	7/8	1-1/8	1-1/8
250	7/8	7/8	1-1/8	1-1/8
275	7/8	1-1/8	1-1/8	1-1/8
300	7/8	1-1/8	1-1/8	1-1/8

GPRC-90				
Total Equiv. Length (Ft)	Liquid Line Size (OD")			
	Horizontal or Downflow	Upflow 1-5 Ft	Upflow 6-10 Ft	Upflow 11-15 Ft
25	1-1/8	1-1/8	1-1/8	1-1/8
50	1-1/8	1-1/8	1-1/8	1-1/8
75	1-1/8	1-1/8	1-1/8	1-1/8
100	1-1/8	1-1/8	1-1/8	1-1/8
125	1-1/8	1-1/8	1-1/8	1-1/8
150	1-1/8	1-1/8	1-1/8	1-1/8
175	1-1/8	1-1/8	1-1/8	1-1/8
200	1-1/8	1-1/8	1-1/8	1-1/8
225	1-1/8	1-1/8	1-1/8	1-1/8
250	1-1/8	1-1/8	1-1/8	1-1/8
275	1-1/8	1-1/8	1-1/8	1-1/8
300	1-1/8	1-1/8	1-1/8	1-1/8

GPRC-105				
Total Equiv. Length (Ft)	Liquid Line Size (OD")			
	Horizontal or Downflow	Upflow 1-5 Ft	Upflow 6-10 Ft	Upflow 11-15 Ft
25	1-1/8	1-1/8	1-1/8	1-1/8
50	1-1/8	1-1/8	1-1/8	1-1/8
75	1-1/8	1-1/8	1-1/8	1-1/8
100	1-1/8	1-1/8	1-1/8	1-1/8
125	1-1/8	1-1/8	1-1/8	1-1/8
150	1-1/8	1-1/8	1-1/8	1-1/8
175	1-1/8	1-1/8	1-1/8	1-1/8
200	1-1/8	1-1/8	1-1/8	1-1/8
225	1-1/8	1-1/8	1-1/8	1-1/8
250	1-1/8	1-1/8	1-1/8	1-1/8
275	1-1/8	1-1/8	1-1/8	1-1/8
300	1-1/8	1-1/8	1-1/8	1-3/8

GPRC-140				
Total Equiv. Length (Ft)	Liquid Line Size (OD")			
	Horizontal or Downflow	Upflow 1-5 Ft	Upflow 6-10 Ft	Upflow 11-15 Ft
25	1-1/8	1-1/8	1-1/8	1-1/8
50	1-1/8	1-1/8	1-1/8	1-1/8
75	1-1/8	1-1/8	1-1/8	1-1/8
100	1-1/8	1-1/8	1-1/8	1-1/8
125	1-1/8	1-1/8	1-1/8	1-1/8
150	1-1/8	1-1/8	1-1/8	1-1/8
175	1-1/8	1-1/8	1-1/8	1-3/8
200	1-1/8	1-1/8	1-1/8	1-3/8
225	1-1/8	1-1/8	1-1/8	1-3/8
250	1-1/8	1-1/8	1-3/8	1-3/8
275	1-1/8	1-1/8	1-3/8	1-3/8
300	1-1/8	1-1/8	1-3/8	1-3/8

GPRC-175				
Total Equiv. Length (Ft)	Liquid Line Size (OD")			
	Horizontal or Downflow	Upflow 1-5 Ft	Upflow 6-10 Ft	Upflow 11-15 Ft
25	1-3/8	1-3/8	1-3/8	1-3/8
50	1-3/8	1-3/8	1-3/8	1-3/8
75	1-3/8	1-3/8	1-3/8	1-3/8
100	1-3/8	1-3/8	1-3/8	1-3/8
125	1-3/8	1-3/8	1-3/8	1-3/8
150	1-3/8	1-3/8	1-3/8	1-3/8
175	1-3/8	1-3/8	1-3/8	1-3/8
200	1-3/8	1-3/8	1-3/8	1-3/8
225	1-3/8	1-3/8	1-3/8	1-3/8
250	1-3/8	1-3/8	1-3/8	1-3/8
275	1-3/8	1-3/8	1-3/8	1-3/8
300	1-3/8	1-3/8	1-3/8	1-3/8

GPRC-210				
Total Equiv. Length (Ft)	Liquid Line Size (OD")			
	Horizontal or Downflow	Upflow 1-5 Ft	Upflow 6-10 Ft	Upflow 11-15 Ft
25	1-3/8	1-3/8	1-3/8	1-3/8
50	1-3/8	1-3/8	1-3/8	1-3/8
75	1-3/8	1-3/8	1-3/8	1-3/8
100	1-3/8	1-3/8	1-3/8	1-3/8
125	1-3/8	1-3/8	1-3/8	1-3/8
150	1-3/8	1-3/8	1-3/8	1-3/8
175	1-3/8	1-3/8	1-3/8	1-3/8
200	1-3/8	1-3/8	1-3/8	1-5/8
225	1-3/8	1-3/8	1-3/8	1-5/8
250	1-3/8	1-3/8	1-3/8	1-5/8
275	1-3/8	1-3/8	1-5/8	1-5/8
300	1-3/8	1-3/8	1-5/8	1-5/8

Figure 6: Discharge Line Sizing

Model	Horizontal or Downflow Discharge Line Sizes (OD")											
	Total Equivalent Length (Ft)											
	25	50	75	100	125	150	175	200	225	250	275	300
GPRC-20	5/8	5/8	5/8	5/8	3/4	3/4	3/4	3/4	3/4	3/4	3/4	7/8
GPRC-30	7/8	7/8	7/8	7/8	7/8	7/8	7/8	7/8	7/8	7/8	7/8	7/8
GPRC-40	7/8	7/8	7/8	7/8	7/8	7/8	7/8	1-1/8	1-1/8	1-1/8	1-1/8	1-1/8
GPRC-50	7/8	7/8	1-1/8	1-1/8	1-1/8	1-1/8	1-1/8	1-1/8	1-1/8	1-1/8	1-3/8	1-3/8
GPRC-70	7/8	1-1/8	1-1/8	1-3/8	1-3/8	1-3/8	1-3/8	1-3/8	1-3/8	1-3/8	1-5/8	1-5/8
GPRC-90	1-1/8	1-1/8	1-1/8	1-1/8	1-3/8	1-3/8	1-3/8	1-3/8	1-3/8	1-3/8	1-5/8	1-5/8
GPRC-105	1-1/8	1-1/8	1-1/8	1-3/8	1-3/8	1-3/8	1-3/8	1-3/8	1-3/8	1-5/8	1-5/8	1-5/8
GPRC-140	1-1/8	1-3/8	1-3/8	1-3/8	1-5/8	1-5/8	1-5/8	1-5/8	1-5/8	1-5/8	1-5/8	2-1/8
GPRC-175	1-3/8	1-3/8	1-3/8	1-5/8	1-5/8	1-5/8	1-5/8	1-5/8	2-1/8	2-1/8	2-1/8	2-1/8
GPRC-210	1-5/8	1-5/8	1-5/8	1-5/8	1-5/8	1-5/8	2-1/8	2-1/8	2-1/8	2-1/8	2-1/8	2-1/8

Circuit Tons	Upflow Discharge Line Sizes (OD")											
	Total Equivalent Length (Ft)											
	25	50	75	100	125	150	175	200	225	250	275	300
GPRC-20	5/8	5/8	5/8	5/8	A-3/8 B-5/8	A-3/8 B-5/8	A-3/8 B-5/8	A-3/8 B-5/8	A-3/8 B-5/8	A-3/8 B-5/8	A-3/8 B-5/8	A-3/8 B-3/4
GPRC-30	A-3/8 B-3/4	A-3/8 B-3/4	A-3/8 B-3/4	A-3/8 B-3/4	A-3/8 B-3/4	A-3/8 B-3/4	A-3/8 B-3/4	A-3/8 B-3/4	A-3/8 B-3/4	A-3/8 B-3/4	A-3/8 B-3/4	A-3/8 B-3/4
GPRC-40	A-3/8 B-3/4	A-3/8 B-3/4	A-3/8 B-3/4	A-3/8 B-3/4	A-3/8 B-3/4	A-3/8 B-3/4	A-3/8 B-3/4	A-1/2 B-7/8	A-1/2 B-7/8	A-1/2 B-7/8	A-1/2 B-7/8	A-1/2 B-7/8
GPRC-50	7/8	7/8	A-1/2 B-7/8	A-1/2 B-7/8	A-1/2 B-7/8	A-1/2 B-7/8	A-1/2 B-7/8	A-1/2 B-7/8	A-1/2 B-7/8	A-1/2 B-7/8	A-1/2 B-1-1/8	A-1/2 B-1-1/8
GPRC-70	7/8	7/8	A-1/2 B-7/8	A-1/2 B-7/8	A-1/2 B-1-1/8	A-1/2 B-1-1/8	A-1/2 B-1-1/8	A-1/2 B-1-1/8	A-1/2 B-1-1/8	A-1/2 B-1-1/8	A-5/8 B-1-3/8	A-5/8 B-1-3/8
GPRC-90	1-1/8	1-1/8	1-1/8	1-1/8	A-3/4 B-1-1/8	A-3/4 B-1-1/8	A-3/4 B-1-1/8	A-3/4 B-1-1/8	A-3/4 B-1-1/8	A-3/4 B-1-1/8	A-3/4 B-1-1/8	A-3/4 B-1-1/8
GPRC-105	1-1/8	1-1/8	1-1/8	A-3/4 B-1-1/8	A-3/4 B-1-1/8	A-3/4 B-1-1/8	A-3/4 B-1-1/8	A-3/4 B-1-1/8	A-3/4 B-1-1/8	A-3/4 B-1-3/8	A-3/4 B-1-3/8	A-3/4 B-1-3/8
GPRC-140	1-1/8	1-3/8	1-3/8	1-3/8	A-3/4 B-1-3/8	A-3/4 B-1-3/8	A-3/4 B-1-3/8	A-3/4 B-1-3/8	A-3/4 B-1-3/8	A-3/4 B-1-3/8	A-3/4 B-1-3/8	A-3/4 B-1-3/8
GPRC-175	1-3/8	1-3/8	1-3/8	A-3/4 B-1-3/8	A-3/4 B-1-3/8	A-3/4 B-1-3/8	A-3/4 B-1-3/8	A-3/4 B-1-3/8	A-3/4 B-1-3/8	A-3/4 B-1-3/8	A-3/4 B-1-3/8	A-3/4 B-1-3/8
GPRC-210	1-5/8	1-5/8	1-5/8	1-5/8	1-5/8	1-5/8	A-3/4 B-1-5/8	A-3/4 B-1-5/8	A-3/4 B-1-5/8	A-3/4 B-1-5/8	A-3/4 B-1-5/8	A-3/4 B-1-5/8

Refrigerant Charge Determination. The approximate amount of refrigerant charge required by the system varies based on the total length of the refrigerant lines and the size of the chiller. Referring to Figure 7, determine the amount of charge based on the model of the chiller and the amount of charge based on discharge and liquid line sizes and lengths. Add these three numbers together to find the final operating charge. The final operating charge must be verified by running the system and checking the liquid line sight glass.

Figure 7: Refrigerant Charge Determination

Chiller Model	Condenser and Chiller Charge (LBS of R-410a)								
	Minimum Design Ambient - °F								
	60	50	40	30	20	10	0	-10	-20
GPRC-20	9	9	10	11	12	13	13	13	14
GPRC-30	10	10	12	14	15	16	16	17	17
GPRC-40	13	13	15	17	19	20	21	21	22
GPRC-50	18	19	22	25	27	29	30	31	32
GPRC-70	25	25	25	26	31	34	36	38	40
GPRC-90	30	30	30	32	37	41	44	47	49
GPRC-105	51	51	51	52	52	58	63	67	71
GPRC-140	51	51	51	51	51	51	55	55	65
GPRC-175	70	70	70	70	70	70	76	76	88
GPRC-210	80	80	80	80	80	80	80	88	94

Line Size OD (inches)	Discharge Line LBS of R-410a	Liquid Line LBS of R-410a
3/8	0.3	3.2
1/2	0.6	6.0
5/8	1.0	9.6
3/4	1.5	14.4
7/8	2.1	20.0
1-1/8	3.7	34.1
1-3/8	5.6	52.0
1-5/8	7.9	73.6
2-1/8	13.7	128.0
2-5/8	21.2	197.4

Note: The amounts listed above are based on 100 feet of pipe. Actual amounts will be in direct proportion to the actual length of the piping.

Oil Charge Determination. The remote air-cooled portable chillers are factory charged with the amount of oil required without field-installed piping. Additional oil required is dependent on the amount of additional refrigerant added.

Calculate the amount of additional oil required by using the following formula:

$$\text{Pints of oil (Copeland Ultra 22cc)} = \text{lbs of R-410a added for field installed piping} / 100.$$

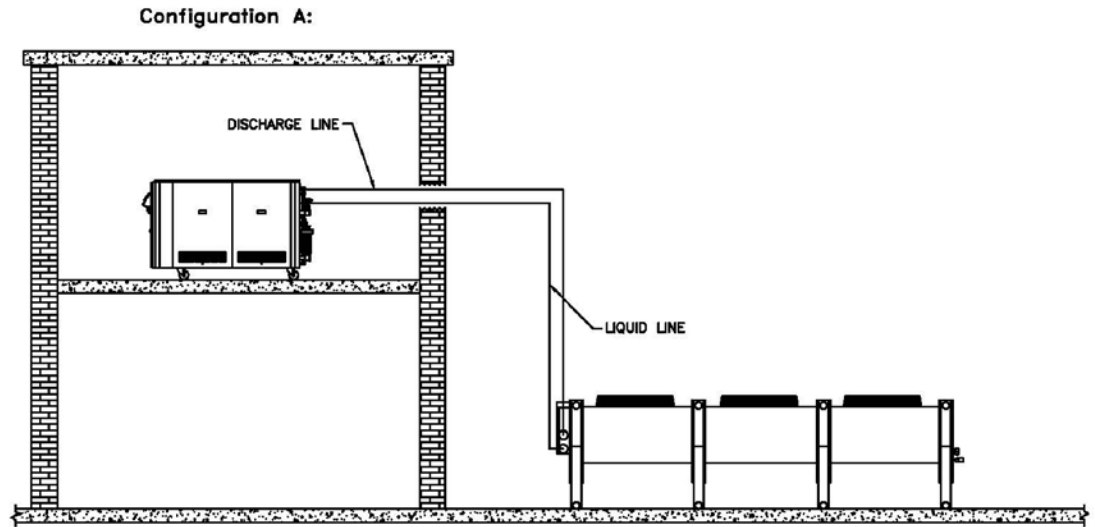

* Liquid line riser should not exceed 15 feet from base of air-cooled condenser.

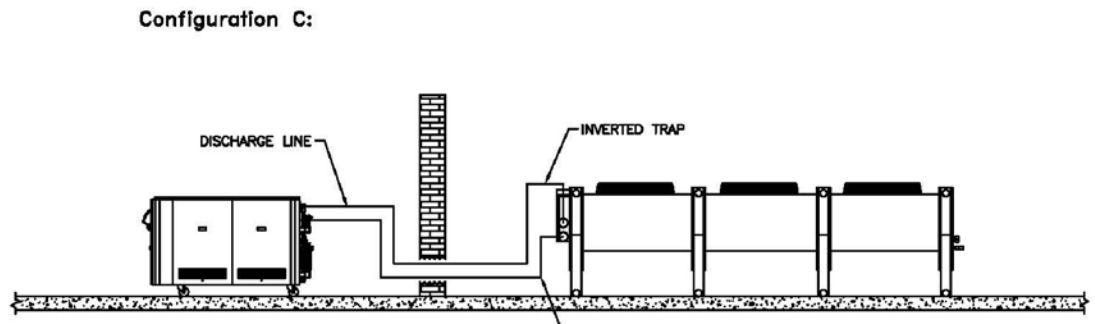
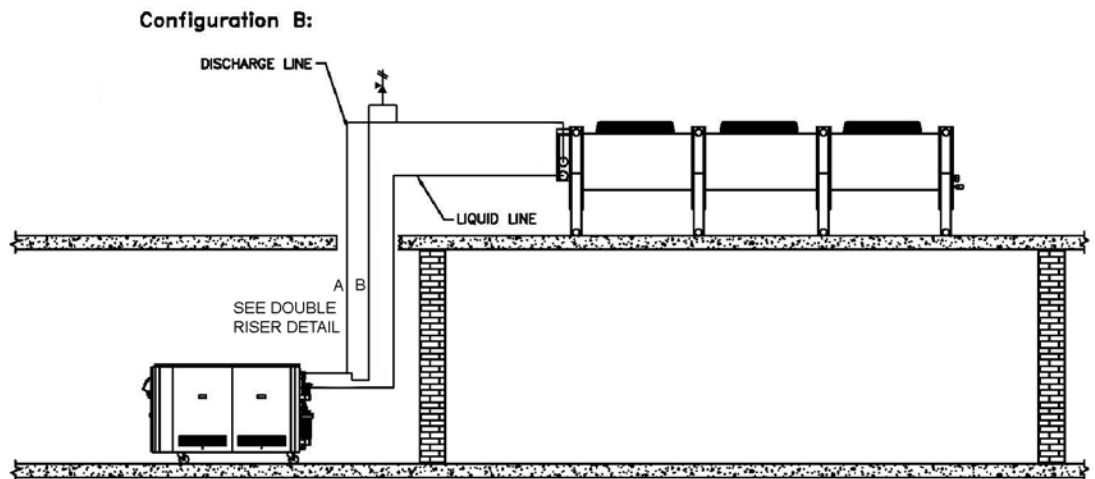

Figure 8: Remote Condenser Configurations

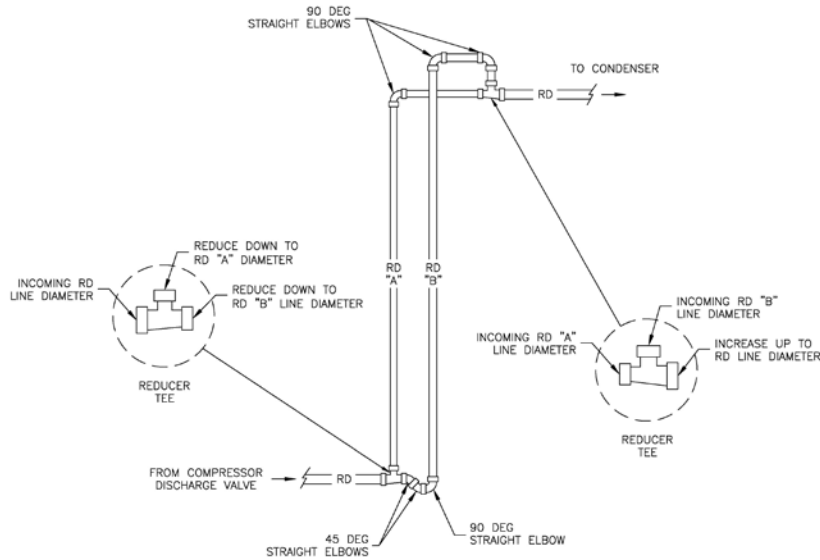

Figure 9: Double Riser Detail

3-8 Checking Motor Direction

All of our portable chillers have their motor rotations properly phased at the factory. If compressors, pumps, or fans are running in reverse rotation, disconnect and lock out the power source and reverse any two power leads into the chiller disconnect switch.

Caution! *Do not switch leads at the motors, motor starters, or contactors.*

Three-Phase Compressors

Scroll compressors are directionally-dependent and compress in one rotational direction. Reversing rotation direction results in an elevated sound level and a substantially-reduced current draw.

Caution! *Do not allow the compressor to run backwards for any length of time. Doing so will result in compressor damage..*

Water Pumps

Correct pump rotation is indicated by a positive pressure of 20 to 40 psi shown on the home screen of the display. Pump rotation should be clockwise when viewed from the motor end. For chillers with optional pumps, check the appropriate pump curve in the Appendix.

Caution! *Do not run pump dry. Doing so will result in seal damage.*

Condenser Fan

Air should be drawn through the condenser and discharged vertically from the chiller.

3-9 Water Reservoir

The standard water reservoir is rotationally molded polyethylene with a removable lid. The tank is fully insulated to assist maintaining fluid temperature. All portable chillers shipped during the fall, winter, or spring, or those units that are shipped from stock are flushed at the factory with a water/ethylene glycol solution to prevent piping components prone to retaining water from freezing. During startup and when additional solution is required, refer to the ethylene glycol and propylene glycol curves in Figure 11: Ethylene Glycol and Propylene Glycol Curves on page 30. Add a pre-mixed solution of industrial quality (not automotive), inhibited ethylene glycol or propylene glycol and water to provide freeze protection to a temperature 20°F (11°C) below the normal chiller operating temperature set point.

Glycol and/or water, with an inhibitor, should be used to protect the materials (copper, steel, stainless steel, and bronze) in the system from corrosion. If you intend to use straight water, we strongly advise a minimum leaving water temperature of 45°F (7°C) or contact the service department.

Warning! *Operating the chiller setpoint below 45°F (7°C) without the proper amount of glycol for freeze protection could result in a damaged evaporator. ACS Group does not warrant the freeze up of the evaporator under any circumstances.*

The following glycol products are available:

Part Number	Description
A0541358	Ethylene glycol, 5 gallons (18.9 liters)
A0539637	Ethylene glycol, 55 gallons (208.2 liters)
A0542990	Propylene glycol, 5 gallons (18.9 liters)
A0542991	Propylene glycol, 55 gallons (208.2 liters)

Caution! *Do not connect make-up water directly to the chilled water reservoir unless you have an approved automatic water make-up system installed.*

Caution! *Do not pressurize tank. Supply and return connections must be trapped and vented to allow vertical risers to drain into tank. Do not overfill system. Allow enough free space in tank for vertical piping to drain.*

If your application has chilled water or process piping above the chiller, trap and vent the supply and return lines to allow vertical piping to drain into tank.

Note: *In applications where the process or process piping is above the reservoir, take steps to prevent over pressurization of the reservoir. This condition can occur on system shutdown when the water in the system drains into the reservoir. To prevent this, a vacuum breaker should be installed at the high point of the “To Process” and “From Process” lines.*

Figure 10: Suggested Overhead Piping Configuration

WARNING

DO NOT OVER FILL SYSTEM. ALLOW ENOUGH FREE SPACE IN TANK FOR VERTICAL PIPING TO DRAIN

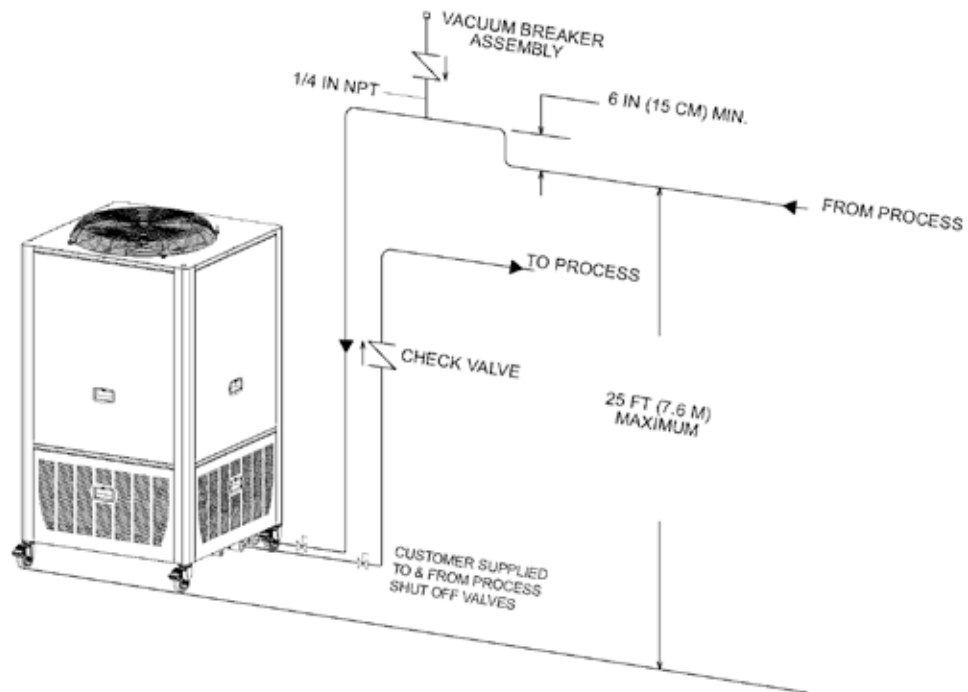
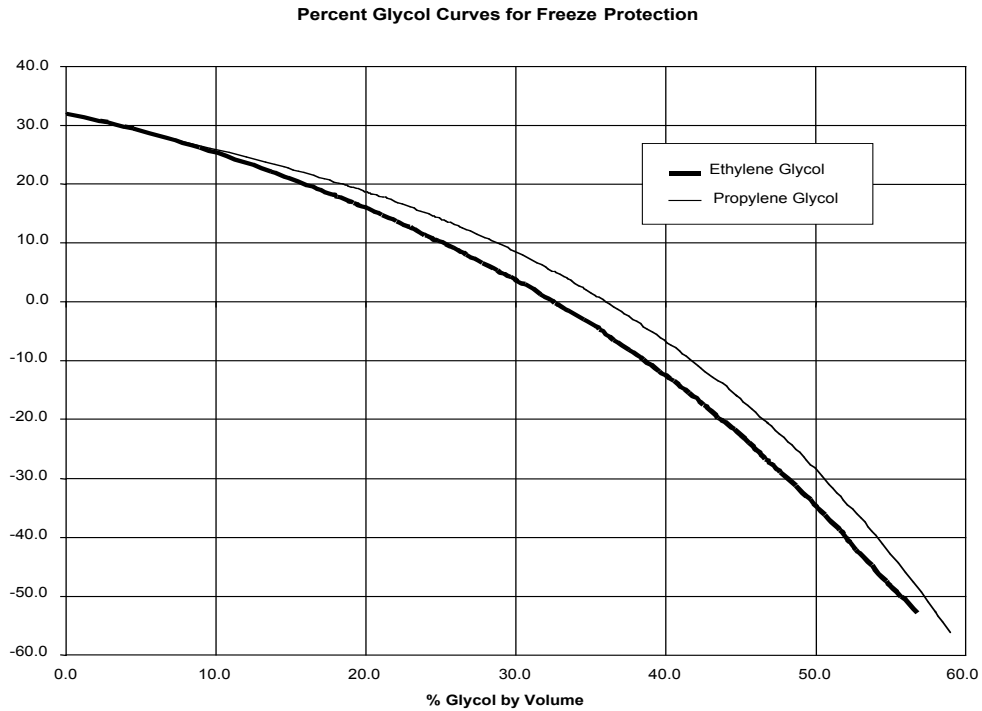

Figure 11: Ethylene Glycol and Propylene Glycol Curves



Example: 45°F set point minus 20°F = 25°F.

From Figure 28, 25°F equates to 10% by volume of glycol required.

Note: *The standard pumps used in the GPAC Serice chillers are not recommended to be used with fluid below 0°F (-18°C). Please consult factory for the proper pump.*

3-10 Automatic Water Make-Up Option

The chiller may be connected to an automatic make-up system if the optional package (pipe fittings, solenoid valve and 1/2" NPT city water make-up connection) is factory installed.

Note: *When the unit is selected with the optional, closed stainless steel tank, a pressure reducing valve is added to the automatic water make-up option. This valve is set to be full open at 5 psig (0.3 bar).*

If the automatic make-up system is connected to a city water system, make provisions to prevent backflow contamination. Install an approved backflow preventer in accordance with local codes.

Caution! *Adding straight city water into a glycol/water mixture dilutes the solution and eventually leads to system freeze-up. Damage from freeze-up is not covered by the warranty.*

To prevent system freeze-up in automatic make-up applications, we recommend using either a chemical feeder or make-up reservoir to replenish glycol. Contact the sales department for more information about these configurations.

3-11 Initial Start-Up

- Check the shipping papers against the serial tag to be sure chiller size, type and voltage is correct for the process that will be controlled. Portable chillers are built with a voltage specific compressor and cannot be re-wired for an alternate voltage.

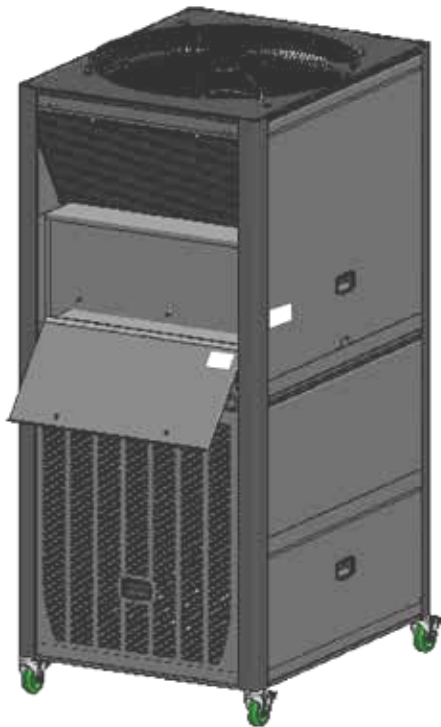

Model No.	Serial No.				Ctrl. Volt 115 VA
Flem Diag	Ph	FLA			RMS MAX V KA
Line Volt	Ph	FLA			
Max. Feeder Overcurrent Protection		Amps			
Comp HP	RLA	Process Pump HP	FLA		
Fan HP	FLA				
Min Temp* 20 F	Refrigerant Type 410A				
Max Temp* 80 F	Refrigerant Weight LBS				
Refrig Press tested to 575 PSI Max Refrig. Press 620 PSI					
ACS GRP, 2900 South 160 th Street New Berlin, WI 53151 USA					

- Check the transformer primary voltage connections to be sure they are configured for the electrical power you are using. The voltage at the main power connection must read within plus or minus ten percent ($\pm 10\%$) of the voltage listed on the serial tag. Electrical connections must conform to all applicable codes.

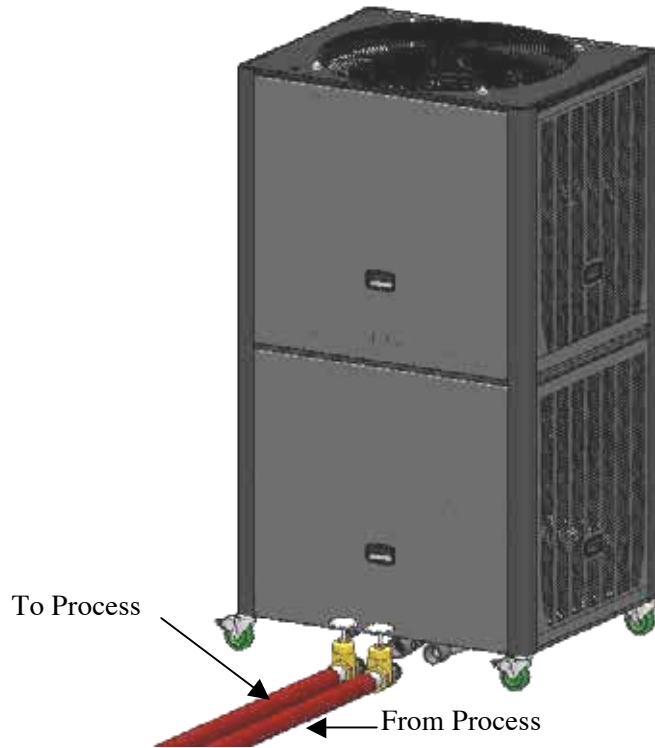

- Complete chilled water To Process and From Process connections. It is suggested that shut-off valves are added to unit to control the flow rate to process and for completely isolating the chiller from the process.

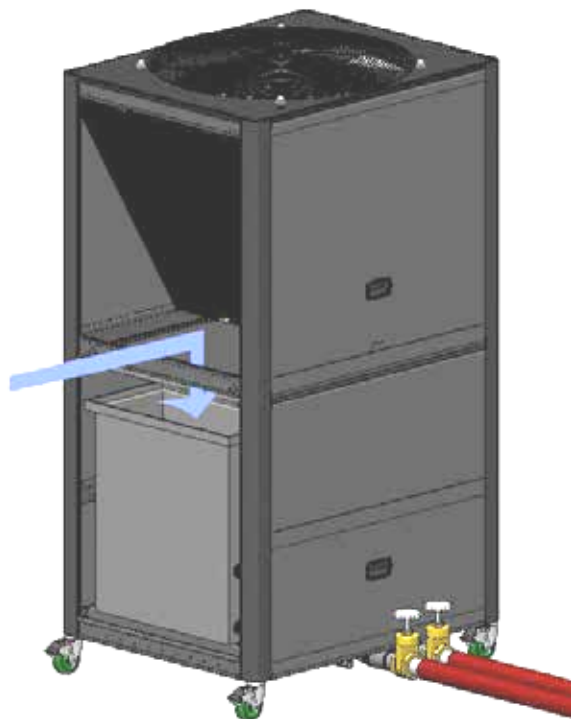

- If the optional automatic water make-up system was not installed on the chiller, remove the side panel to the left of the process connections and fill the tank and chilled water circuit piping until the tank is approximately $\frac{3}{4}$ full. Fill with water (or a water/glycol mixture if the desired setpoint is lower than 45°F (7°C)). The water/ glycol mixture should provide for freeze protection to at least 20°F (11°C) below the leaving water temperature you want.

Warning! Operating the chiller setpoint below 45°F (7°C) without the proper amount of glycol for freeze protection could result in a damaged evaporator. ACS Group does not warrant the freeze up of the evaporator under any circumstances.

- The air-cooled condenser should have an adequate supply of 75° to 115°F (24° to 46°C) air for proper operation.
- The tower or city water condenser cooling in and out connections should be completed and an adequate supply of 85°F (30°C) tower or 70°F (21°C) city water, at 25 psi pressure, for proper operation.

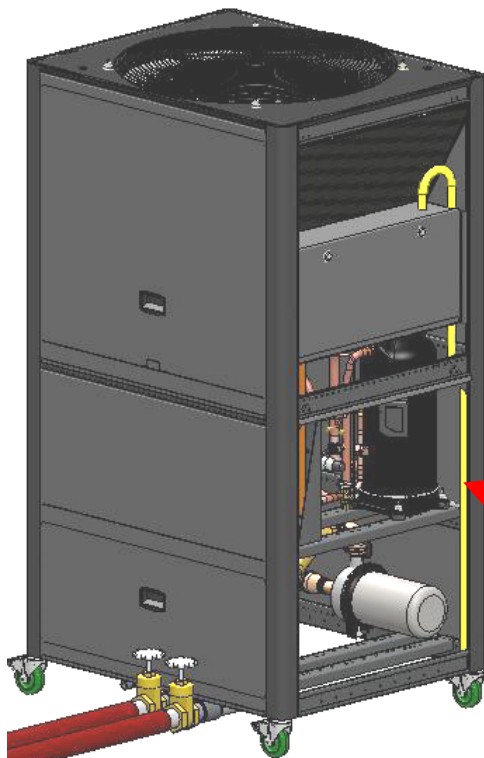

- Connect the main 3 phase incoming power to the unit making certain that line one (1) L1 is connected to the A phase, line two (2) L2 is connected to the B phase, and line three (3) L3 is connected to the C phase. Check for proper rotation direction of fan(s) and pump(s). The best route for the main power wiring is from the floor up to the right side of the enclosure on the top.

Power Cable (highlighted in yellow)

The crankcase heater is automatically energized when the main power is applied (main power switch in the ON (|) position). It should be on for at least 24 hours before startup to force dissolved refrigerant from the compressor oil.

Finally, the cable for the display is coiled up under the control enclosure and the display is shipped inside the control enclosure. The handle on the panel in front of the control enclosure has a hole in the corner to feed the cable to the outside of the cabinet. Plug the cable into the back of the display.

Turn the power switch to the ON (|) position. The display's backlight will turn on and the controller will go through a self-diagnostic routine prior to displaying the main status screen.

3-12 Finishing Setup: Setting Up Passwords

You can establish passwords for two levels of security: operators and supervisors. The controller comes from the factory with neither password set. This allows every user access to all functions.







Warning! If you choose to establish passwords store them in a secure location because if they are forgotten there is no way to reset them without a service call.

Operator Password. If you define a password for operators, then a password will be required to carry out any function (other than reviewing the status screens). Entering the operator's password will give the user access to the setpoints for leaving temperature, high temperature warning, high temperature fault.







Note: *If you choose to define an Operator Password you must also define a Supervisor Password to complete the security setup.*

Supervisor Password. If you define a password for supervisors (or setup personnel) then most settings can be changed only after entering the password. The password will be required to display the extended setpoints for operating parameters and alarms. Section 4-6 shows a table of setpoints and the restrictions between Operator and Supervisor.

To set password protections:

1. Press the  button to access the menu screen.
2. Press the  or  to highlight SETPOINTS, and press .
3. Press the  or  until the following screen appears for the Operator or Supervisor Password



4. Press  to accept the screen, and then press  until the Operator or Supervisor Password line is highlighted.
5. Press  or  to increment or decrement the number. The password can be between 0 and 9999.
6. Press  to accept the Password and move to the next line.
7. For either Operator or Supervisor password the time that the password will allow the controller to be active can be set by the Operator or Supervisor Password Time. With the PW Time value highlighted, press  or  to increment or decrement the time. The password time for either setup can be from 0 to 99 minutes.

Chapter 4: Operation

4-1 Panel Buttons, Indicator Lights, and Switches

Microprocessor Controller

The standard chillers use a microprocessor-based PID controller. The Carel PCO controller is located in the control enclosure. The Carel PGD1 Interface is housed in a block of rigid plastic with a magnetic backing that allows the user to “stick” the interface on any metallic surface. The GP20 through GP50 units come standard with a 10 ft (3 m) cable, and the GP70 through GP210 units come standard with a 20 ft (6 m) cable. Longer cables are available through the After Market Sales Group. The controller is factory set and adjusted; no field adjustment to the internal controls is necessary. The standard operation range is 20°F to 80°F (-7°C to 27°C).

Warning! *Operating the chiller setpoint below 45°F (7°C) without the proper amount of glycol for freeze protection could result in a damaged evaporator. ACS Group does not warrant the freeze up of the evaporator under any circumstances.*

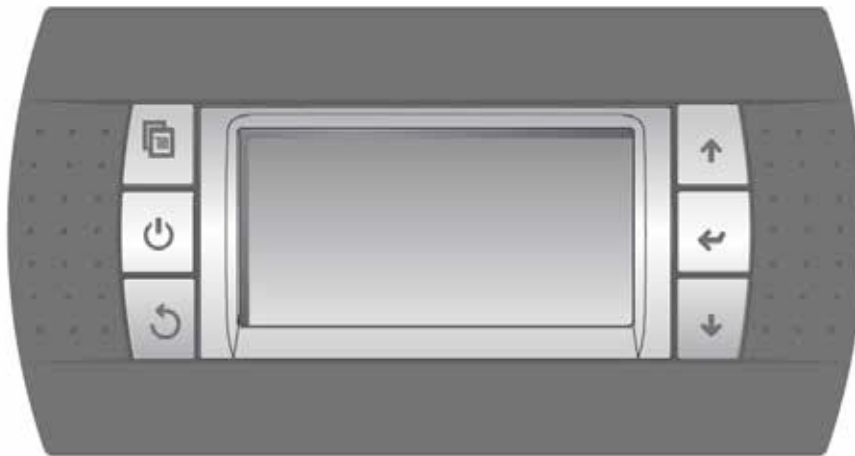







Figure 12: Controller Display

Button	Button Description	Detailed description
	Menu Button	Used to access the menus structure of the PGD interface
	On/Off Button	Used to turn the entire chiller On or Off. The button is backlit and will turn amber when the chiller is On.
	Back Button	Used to back up from a menu and return to the main status screen
	Up Arrow Button	Used to increment a data field or scroll up within a menu structure.
	Enter Button	Used to accept a data field value or to select a menu item.
	Down Arrow Button	Used to decrement a data field or scroll down within a menu structure.

4-2 Initial Start-up

1. Verify the initial start-up checklist from Chapter 3, Section 3-11.
2. With the main supply power switch in the ON position, the screen will display the version of the software for a period of 5 seconds, and then display the main status screen.



Figure 13: Main Status Screen





3. Set the Leaving Fluid temperature by depressing the  button to display the menu.



Figure 14: Menu Screen

4. Depress the  or  button to highlight SETPOINTS and press . If passwords were setup (See Section 3-12 for information on the controller passwords) the password screen will appear.













Enter the established Operator Password by depressing the  to move the position of the cursor, and then depressing the  or  button to increment or decrement the number. Once all of the numbers have been entered depress the  to accept the password. The following screen will appear.



Figure 15: Operator Setpoints Screen

5. Depress  to move the cursor to the CHILLED FLUID SP line. Use the  or  button to increment or decrement the value. Depress  to accept the value and move the cursor down one line.
6. Depress the  button twice to return to the main status screen.
7. Depress the  to start the chiller.
8. Check pump rotation
9. Check the pump amp draw and pump pressure. Make sure that the amp draw reading is within the running load and service factor amps.
10. Operate the chiller, looking for any leaks and listening for unusual noises or vibrations that could indicate improper operation.

Elevated sound level and substantially reduced current draw indicate reverse rotation. After several minutes of operation, the compressor internal protector trips.

4-3 Status Screens

The controller has eight (8) preconfigured status screens. The main status screen (shown in Figure Figure 16) shows the main operating points of the chiller: Entering and Leaving fluid temperatures; Leaving fluid setpoint, pump discharge pressure, tank fluid level (depth), and percentage of hot-gas bypass output.



Figure 16: Main Chiller Status Screen

Depressing  cycles through the following screens (shown below) – Analog I/O, Digital I/O, and Test. The Analog and Digital I/O screens provide status of all of the inputs and outputs for the controller. The Test aides in troubleshooting the chiller when it is not functioning properly by displaying the basic information that a service person will need to know to determine the problem.

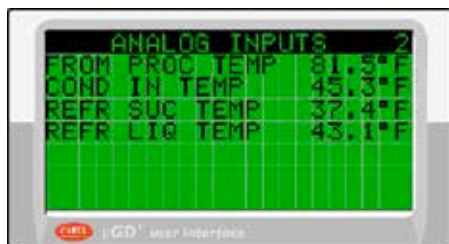
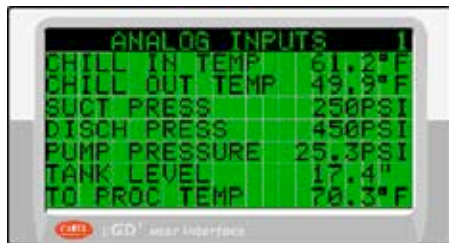
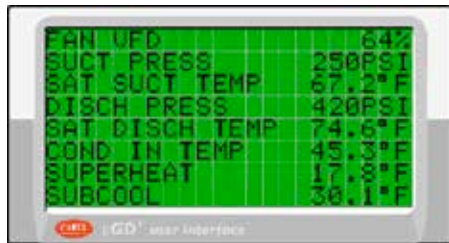

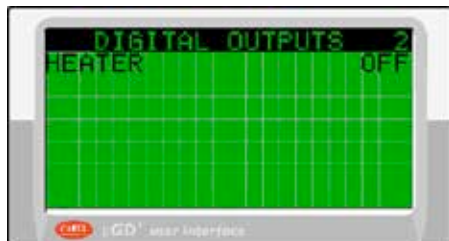
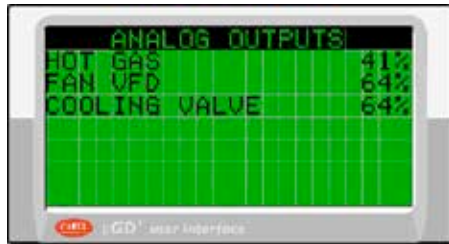



The chiller can be equipped with a tempered fluid loop inside of the chiller. If this option is installed, the main screen changes to the following.



4-4 Access Levels

The controller is setup to allow access to three distinct password groups: operator, supervisor, and service. Operator access allows the user to modify the Leaving Water Temp, Hi Temp Warning, and Hi Temp Fault setpoints. Supervisor access allows the supervisor to modify the above plus

Selecting any of the menus in the Menu Screen will display the Password Screen.



4-5 Controller Setpoints

Variable	Description	Access Level	
		Operator	Supervisor
Chilled Fluid SP	Temperature of chilled fluid out to process	x	x
Chil Hi Temp Wrn	Setpoint for alarm to warn when chilled leaving fluid temperature is too high	x	x
Chil Hi Temp Flt	Setpoint to shut down pump and compressor based on leaving fluid temperature	x	x
Process SP	Temperature of tempered fluid out to process	x	x
Proc Hi Temp Wrn	Setpoint for alarm to warn when tempered leaving fluid temperature is too high	x	x
Proc Hi Temp Flt	Setpoint for alarm to warn when tempered leaving fluid temperature is too high	x	x
Proc Low Temp Wrn	Setpoint for alarm to warn when tempered leaving fluid temperature is too low	x	x
Proc Low Temp Flt	Setpoint for alarm to warn when tempered leaving fluid temperature is too low	x	x
Cooling Enabled	Refrigeration system allowed to operate		x
Heating Enabled	Optional Process temperature heater allowed to operate		x
Fluid Freeze Point	Lowest temperature fluid will operate without freezing. Below 32°F (0°C) glycol must be added. Forces lowest Chilled fluid setpoint to be 13°F (7°C) above FFP		x
Chill On Diff	Temperature difference above chilled fluid setpoint before compressor turns on		x
Chill Off Diff	Temperature difference below chilled fluid setpoint before compressor turns off		x
Proc On Diff	Temperature difference below process setpoint before process heater turns on		x
Proc Off Diff	Temperature difference above process setpoint before process heater turns off		x
Proc Hi Temp Dly	Time (in seconds) Process High Temperature alarm is ignored before activating		x

Variable	Description	Access Level	
		Operator	Supervisor
Chil Hi Temp Dly	Time (in seconds) Chilled High Temperature alarm is ignored before activating		x
Hi Temp Flt Type	When set to CRIT, chiller and process high temp alarms will deactivate compressors and pumps. When set to WARN, compressors and pumps are allowed to continue to operate when a high temp alarm occurs		x
Chil Lo T Wrn Dif	Temperature difference below the chiller setpoint before the chiller low temp warning alarm occurs		x
Chil Lo T Flt Dif	Temperature difference below the chiller setpoint before the chiller low temp fault alarm occurs.		x
Comp, Lead Cmp On Delay	Temperature Difference between Leaving Fluid Temperature and Setpoint to turn on the compressor		x
Comp, Lead Cmp Off Delay	Temperature Difference between Leaving Fluid Temperature and Setpoint to turn off the compressor		x
Lag Cmp On Dly	Time (in minutes) before lag compressor is energized once Chilled fluid reaches 2°F (1.1°C) above Chilled Fluid setpoint		x
Lag Cmp Off Dly	Time (in minutes) before lag compressor is de-energized once chilled fluid reaches 2°F (1.1°C) below Chilled Fluid setpoint		x
Cond Fan Start	Discharge pressure which energizes condenser fan		x
Cond Fan Stop	Discharge pressure which de-energizes condenser fan		x
Pump Stop Delay	Delay time in seconds between fault and stopping the pump		x
Heater On Delay	Time (in seconds) before the heater is allowed to activate once the last compressor stages off		x
Heater Cycle Tm	Time (in seconds) between sampling the output of the heater's PID loop. For example, if this variable is set to ten (10), the heater PID loop output is checked every ten seconds. If the heater PID loop output is 70% when sampled the heater output will be on for 7 seconds and off for 3 seconds.		x
Heater P	P parameter of the heater PID loop		x
Heater I	I parameter of the heater PID loop		x
Heater D	D parameter of the heater PID loop		x
Cooling Valve P	P parameter of the cooling valve PID loop		x
Cooling Valve I	I parameter of the cooling valve PID loop		x
Cooling Valve D	D parameter of the cooling valve PID loop		x
Cooling Valve Mode	When in AUTO, the cooling valve is controlled by the cooling valve PID loop. When in MANUAL, the cooling valve is forced open to the percent dictated by the Cooling Valve Pos variable.		x
Cooling Valve Pos	When the Cooling Valve Mode is set to MANUAL, this variable dictates what percentage the valve is forced to.		x
Tank Min Lvl	Minimum tank level. Used to set the default low tank level alarm setpoints as well as the auto-water makeup on setpoint.		x

Variable	Description	Access Level	
		Operator	Supervisor
Tank Max Lvl	Maximum tank level. Used to set the default high tank level alarm setpoints as well as the auto-water makeup off setpoint.		x
Low Level Fault	Tank level that will activate Low Level Warning fault		x
Low Level Warning	Tank level that will activate Low Level Warning alarm		x
Wtr Makeup On	The tank level to turn on optional water make-up valve; based on size of tank		x
Wtr Makeup Off	The tank level to turn off optional water make-up valve; based on size of tank.		x
High Lvl Warning	Tank level that will activate High Level Warning alarm		x
High Lvl Fault	Tank level that will activate High Level Warning fault		x
Mkup Min Rt X.X"/XXS	The minimum allowable rate for filling the tank		x
Operator Password	4 digit password to limit operator interaction		x
Operator Pw Time	Time in minutes for operator password to be active		x
Sprvisor Password	4 digit password for supervisory interaction		x
Sprvisor Pw Time	Time in minutes for supervisor password to be active		x
Alarm Silence Time	Time in minutes to silence alarm (with optional audible alarm). After time alarm will reactivate.		x
Set Clock	Allows for the time to be set if the clock card option is installed		x
Reset to Defaults	Resets all parameters to the default parameters, including configuration		x









1. Set the Leaving Fluid temperature by depressing the  button to display the menu.



Figure 17: Menu Screen

2. Depress the  or  button to highlight SETTINGS and press . If passwords were setup (See Section 3-12 for information on the controller passwords) the password screen will appear.



Enter the Operator Password by depressing the  to move the position of the cursor, and then depressing the  or  button to increment or decrement the number. Once all of the numbers have been entered depress the  to accept the password. The following screen will appear.

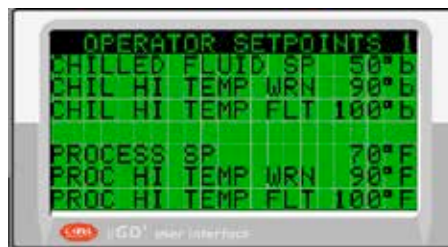







Figure 18: Operator Setpoints Screen

3. Depress  to move the cursor to the Leaving Temp line. Use the  or  button to increment or decrement the value. Depress  to accept the value and move the cursor down one line.
4. Adjust the Hi Temp Warning and Hi Temp Fault in the same manner.
5. Depress the  button twice to return to the main status screen.

4-6 Configuration Settings

Within the Supervisor Menu the chiller can be configured if options are added in the field. These configurations are described below.

Variable	Description	Access Level	
		Operator	Supervisor
Tank Level Inst	Activates/Deactivates the tank level control sensor		x
Auto Water Make-up	Activates the automatic water makeup valve within the controller		x
Fan Control	Set to CYCLING when a standard fan starter is used to control the fan. Set to VFD when a variable frequency drive is used to control the fan		x
Disch Press Cntl	When set to SP, the chiller will control to a static SP. When set to AUTO, the chiller will adjust the discharge pressure setpoint based on the current conditions to increase efficiency.		x
Sensor Pack Inst	Activates the optional temperature sensors for refrigerant liquid line and suction line temperatures, and entering air or water temperature (depending on condenser type)		x
Cond Diff Sw Inst	Activates the optional water cooled condenser differential water pressure switch		x
Chill Diff Sw Inst	Activates the optional evaporator differential water pressure switch		x
Clock Board Inst	Activates the optional controller real time clock card		x
Heater Installed	Activates the optional process heater		x
Analog IN2	Determines how analog input 2 is used. It can be set to CHIL IN (chiller in temperature), FROM PROC (from process temperature), CHIL REM SP (chiller remote setpoint) or PROC REM SP (process remote setpoint).		x
Remote SP Mode	When Analog IN2 is set to REM SP, this determines if the LOCAL (entered through the display) setpoint or REMOTE (Analog IN2) setpoint is used to control the chiller.		x
Rem SP mA Range	Determines the signal type (0-20mA or 2-20mA) for the Remote Setpoint		x
Analog In 6	Determines how analog input 6 is used. It can be set to CHIL IN (chiller in temperature), FROM PROC (from process temperature) or TO PROC (to process temperature).		x
Chil Loop Type	Determines the chiller loop's type (COOL or HEAT/COOL)		x
Proc Loop Type	Determines the process loop's type (COOL, HEAT/COOL or HEAT).		x
Primary Loop	Determines which loop's (PROC or CHIL) information to display on the first status page of the display.		x
Analog Out 2	Determines how analog output 2 is used. It can be set to CHIL IN (retransmission of the chiller in temperature), CHIL OUT (retransmission of the chiller out temperature), FROM PROC (retransmission of the from process temperature), TO PROC (retransmission of the to process temperature) or COOL VLV (process loop cooling valve).		x

Variable	Description	Access Level	
		Operator	Supervisor
Analog Out 3	Determines how analog output 3 is used. It can be set to CHIL IN (retransmission of the chiller in temperature), CHIL OUT (retransmission of the chiller out temperature), FROM PROC (retransmission of the from process temperature) or TO PROC (retransmission of the to process temperature).		x
Analog Out 4	Determines how analog output 4 is used. It can be set to CHIL IN (retransmission of the chiller in temperature), CHIL OUT (retransmission of the chiller out temperature), FROM PROC (retransmission of the from process temperature) or TO PROC (retransmission of the to process temperature).		x
Digital In 8	Determines how digital input 8 is used. It can be set to START/STOP (remote start stop), NO WARNING (normally open warning alarm), NC WARNING (normally closed warning alarm), NO FAULT (normally open fault alarm), NC Fault (normally closed fault), PHASE MNTR (power phase monitor), TMP SAFETY (high temp safety)		x
Start Mode	When Digital In 8 is configured to START/STOP this determines if the chiller's online status is determined by the button on the display (LOCAL) or digital input 8 (REMOTE).		x
Chil Cntl Sens	Determines which sensor is used to control the chiller. It can be set to CHIL OUT (chiller out temperature), CHIL IN (chiller in temperature), TO PROC (to process temperature) or FRM PROC (from process temperature).		x
Proc Cntl Sens	Determines which sensor is used to control the process loop. It can be set to TO PROC (to process temperature) or FRM PROC (from process temperature).		x
Pump 2 OL Alm	When set to CRIT, the pump 2 overload alarm will deactivate compressors and pumps. When set to WARN, compressors and pumps are allowed to continue to run when the pump 2 overload alarm occurs.		x
Flow 2 Alm Type	When set to CRIT, the flow 2 alarm will deactivate compressors and pumps. When set to WARN, compressors and pumps are allowed to continue to run when the flow 2 alarm occurs.		x
Alarm Out	Determines when the alarm output is activated. When set to ALL ALARMS, the output is activated when any new alarm occurs. When set to CRIT ALARMS, the output will only activate when critical alarms (those that force the pump or compressor off) occur.		x
Network Prot	Determines what network protocol is used for communications. This can be set to BACNET485, BACNET IP, MODBUS485, MODBUS IP, LON or WEB.		x
Network Baudrate	Determines the baudrate for communications.		x
Network Address	Determines the network address of the chiller on the network.		x
Units	Determines if STANDARD (English) or METRIC units are used.		x

4-7 Alarms

The controller is setup with multiple alarms, most of them configurable using the Supervisor password. Section 4-5 Controller Setpoints on page 41 gives a list of alarms that the controller is setup to display. The alarms are broken up into two categories – warnings and faults. The warning notifies the user that the parameter has been exceeded and the chiller is allowed to keep operating, but should be monitored to determine the cause of the warning. The fault notifies the user that the parameter has been exceeded and the chiller and pump has been shut down to protect the system.

4-8 Optional Communications

The communications function allows you to monitor and set the parameters by a program prepared and running on a host computer connected to the controller.

Serial communications use a RS-485 hardware interface. Protocols available are BACNet, LONWorks, CANBus, and ModBus RTU (Slave mode only). See Appendix for the controller data that is available through these protocols.

Network communications use a RJ-45 hardware interface using the basic Ethernet TCP/IP layer stack. Protocols available are BACNet (Ethernet, IP, or MS/TP) and ModBus IP. See Appendix for the controller data that is available through these protocols.

Chapter 5: Maintenance

5-1 Lubrication

Grease all fan motors, and pump motors that do not have permanently sealed bearings. Be sure to use an all-purpose industrial grease with a temperature reference of 185° F (85° C). Remove the grease relief plug (motors only) before adding grease, add grease until a small amount pours out, and replace the plug when finished.

Caution! *Failure to remove the grease relief plug will result in dislodging the bearing grease seal, eventually causing bearing failure.*

Refrigeration compressors are hermetically sealed and no lubrication is required.

5-2 Filter Cleaning

Air filter cleaning is important to keep your air-cooled portable chiller operating at peak efficiency and capacity. Clean the filters whenever they appear dirty, or at regularly scheduled intervals.

1. Turn the chiller off.
2. Remove the top side panel(s) to expose the condenser section.
3. Slide the filter rod to release it from the frame at the top and bottom.
4. Wash down the filter with clean water (preferably with a garden hose), directing the flow of water opposite the direction of airflow. If dirt is heavy, use a mild detergent and rinse well. Allow the filter to dry completely before replacing it on the chiller.

Note: *Keep a spare air filter set on hand. Install and use it while cleaning).*

Caution! *Do not use compressed air to blow off a dirty filter. It will not clean very well, and the filter could be damaged. Never run the chiller without properly installed filters.*

5-3 Maintaining the Condenser

Dirty condenser heat exchange surfaces reduce system capacity and efficiency.

Air- and Remote Air-Cooled Chillers

Brush or vacuum light dirt accumulations off the aluminum condenser fins. Avoid bending or damaging them. Heavy dirt accumulations on the fins may require professional cleaning.

Water-Cooled Chillers

Proper water treatment will greatly reduce cleaning intervals.

Coaxial Condensers (GPWC20-50). Remove dirt and slime in the condenser tube water side by reverse-circulating with a mild detergent and water solution. Remove mineral deposits by reverse circulating Liquid Inhibited Acid De-Scaling Solution (Part No. A0502600) through the water side of the condenser. Follow the directions on the container.

Shell & Tube Condensers (GPWC70-210). Remove dirt and slime in the condenser tube water side by cleaning with a nylon tube brush. Remove mineral deposits by reverse circulating Liquid Inhibited Acid De-Scaling Solution (Part No. A0502600) through the tube water side of the condenser. Follow the directions on the container.

The refrigerant side is sealed and requires no routine maintenance.

Caution! *Do not use steam or water over 140°F (60°C) to clean a condenser unless you are monitoring the refrigeration circuit for excessive pressure with gauges. Only a trained technician should use this method.*

5-4 Maintaining the Evaporator

Dirty evaporator heat exchange surfaces reduce system capacity and efficiency. Remove dirt and slime in the evaporator by reverse-circulating with a mild detergent and water solution.

Remove mineral deposits by reverse-circulating Non-Acid De-Scaling Solution (Part No. A0553840). Follow the directions on the container.

5-5 Evaporator Process Piping Y-Strainer

The process piping Y-strainer requires periodic cleaning of its screen to insure the proper flow through the evaporator. To clean the strainer screen, remove the access plug and retaining cap, and pull out the screen.

Wipe, brush, or vacuum out any dirt left in the strainer body. Clean the screen and replace it in the strainer taking care to fit it squarely into the machined seat provided.

Caution! *Do not forget to re-install the screen after cleaning it. Operating the chiller with no strainer screen can potentially plug the evaporator with dirt. The warranty does not cover chiller failures from a dirty evaporator.*

5-6 Preventative Maintenance Service

Follow a systematic preventive maintenance program to help avoid costly down time. Call the Service Department to arrange a schedule of inspections. This service can be tailored to fit your maintenance requirements. These inspections include, but are not limited to:

- Checking refrigerant suction and discharge pressures
- Checking safety and operating conditions
- Checking voltage and amperage of all motors
- Checking all electrical connections
- Checking quantity of refrigerant
- Checking compressor oil level on units with tandem compressors
- Checking lubrication of motor and pump bearings
- Checking circulating pump operation
- Checking flow through heat exchangers
- Checking compressor efficiency
- Checking noise levels

Chapter 6: Troubleshooting

Many problems that can occur while operating the chiller can be avoided by following the recommended installation, operation, and maintenance outlined within this manual. If you do have a problem this Chapter will help you determine the cause and the potential solution.

Before beginning the troubleshooting process

- Locate all wiring, piping, and assembly drawings that were shipped with the chiller. The diagrams will note any custom options not covered in this manual.
- Locate all manuals for any equipment that this chiller is connected to as they may provide additional information to solve the problem.

WARNING!: *Improper installation, operation, or any servicing may result in damage or personal injury*

This chiller should only be installed, operated, and maintained by qualified technical personnel who are familiar with the construction, operation, and potential hazards.

All wiring, disconnects, and over-current protection devices should be installed by a qualified electrician in accordance with all local codes and ordinances in your region.

WARNING!: *Electrical Hazard*

Before performing any service on this equipment disconnect and lockout all electrical sources to prevent injury from unexpected energization or startup. Follow all safety rules when performing any maintenance or service to this equipment.

WARNING!: *Refrigeration Hazard*

Only certified refrigeration technicians should perform any refrigeration related maintenance.

CAUTION!: *Hot Surfaces*

Protect yourself from hot surfaces when working on the refrigeration or process temperature sections of this equipment. These devices can reach temperatures of 180°F (82°C). Allow the equipment to cool prior to performing any maintenance or service.

6-1 Identifying the Cause of a Problem

Types of conditions the user may see include alarm conditions and control problems.

Alarm Conditions

When an alarm condition occurs the  button backlight will flash, and if the optional audible/visual alarm is installed the strobe and horn will energize. The light and horn will remain on until the condition is corrected. Pressing the enter button will silence the audible alarm, but the strobe will continue to flash.

The display will show the cause the alarm and will indicate a possible solution. To accept the alarm press , and follow the suggested solution to correct the alarm condition. The following table shows the possible alarm messages that could appear on the display.

CC = Compressor Critical	SC = System Critical	PC = Process Critical	W = Warning	
Alarm Name	#	Type	Possible Cause	Solution
Compressor Fault	1	CC	MCP Failure	Allow the compressor to cool down. If the compressor does not restart, disconnect power and verify operation of the MCP internal module. Replace if necessary.
			Compressor module has failed	
Discharge Pressure Sensor Failure	2	W	Sensor Failure	Check the wiring connection at the sensor, and at the controller. If necessary replace sensor.
			Electrical connection at sensor open	
			Electrical connection at controller open	
Fan Overload	3	CC	Internal fan motor overload tripped	Allow the fan to cool down. If the fan does not restart when called upon by controller, replace fan motor.
VFD Fault	4	CC	Drive has detected internal fault	Locate the drive and write down the fault code shown on the display of drive. Contact customer service for assistance.
High Discharge Pressure Fault	5	CC	Dirty air cooled condenser or inlet filter	Clean filter or condenser
			Dirty water cooled condenser or condenser valve failure	Clean condenser or verify operation of condenser valve
			Condenser fan overload	See Fan Overload Fault
			Condenser fan VFD fault	See VFD Fault
			Ambient air or condenser water temperature too high	Verify supply temperature or air removal capacity.
			Too much refrigerant in system.	Contact Customer Service for assistance
			Liquid line valves closed.	Verify operation of valve and wiring on controller
High Discharge Pressure Switch	6	CC	Dirty air cooled condenser or inlet filter	Clean filter or condenser
			Dirty water cooled condenser or condenser valve failure	Clean condenser or verify operation of condenser valve
			Condenser fan overload	See Fan Overload Fault
			Condenser fan VFD fault	See VFD Fault
			Ambient air or condenser water temperature too high	Verify supply temperature or air removal capacity.
			Too much refrigerant in system.	Contact Customer Service for assistance
			Liquid line valves closed	Verify operation of valve and wiring on controller
Discharge pressure switch failure	See Discharge Pressure Sensor Failure			
High Suction Pressure Fault	7	CC	From Process fluid temperature too high	Verify flow through system. Make corrections as necessary.

CC = Compressor Critical	SC = System Critical	PC = Process Critical	W = Warning	
Alarm Name	#	Type	Possible Cause	Solution
Low Discharge Pressure Fault	8	CC	Ambient air or condenser water temperature too low	Verify ambient air temperature and air flow or condenser inlet water temperature.
			Too little refrigerant in system.	Contact customer service for service call

			Water cooled condenser valve stuck open	Verify cooling valve operation.
			Fan VFD output at 100%	Verify VFD is in remote versus manual operation. Verify controller output to VFD.
Low Fluid Temp Fault	9	CC	Low process fluid flow	Verify system valve operation and adjust if necessary
			Plugged Y-strainer	Clean y-strainer through blow-down valve or cleaning internal strainer.
Low Suction Pressure Fault	10	CC	System low on refrigerant	Contact Customer Service
			Liquid line valves closed	Verify wiring or output between controller and valve
			Chilled fluid setpoint too close to freeze protection setpoint.	Adjust setpoint or fluid freeze point temperature (will require adding glycol to fluid)
			Process fluid flow rate too low.	Verify system valve operation and adjust if necessary
			Thermal expansion valve failure.	Contact Customer Service
Low Superheat Fault (only will appear if optional sensor pack is installed)	11	CC	Thermal expansion valve failure	Contact Customer
			Temperature Sensor Failure	Verify sensor wiring between controller and sensor.
Suction Pressure Sensor Failure	12	CC	Sensor failure	Check the wiring connection at the sensor, and at the controller. If necessary replace sensor.
			Electrical connection at sensor open	
			Electrical connection at controller open	
Leaving Water Temp Sensor Failure	13	SC	Sensor wires loose from controller terminal block	Check the wiring connection at the controller terminal block
			Sensor wires broke between sensor and controller terminal block.	Replace Sensor
Low Level Fault	14	SC	Tank level too low	Verify tank level parameters. Add fluid if necessary.
			Optional water makeup valve failure	Verify wiring between controller and makeup valve. Replace valve if necessary
			Tank level sensor failure	Replace Sensor
No Flow	15	SC	System valve(s) closed	Verify that all system valves are operational and adjust.
			Low flow sensor failure	Verify the sensor at the sensor and at the terminal block.
			Pump failure	Verify the operation of the pump (i.e. motor circuit protector or pump rotation)

CC = Compressor Critical		SC = System Critical		PC = Process Critical		W = Warning	
Alarm Name	#	Type	Possible Cause	Solution			
Pump Overload	16	SC	Motor circuit protector open	Verify motor circuit protector operation. Verify motor wiring and amp draw while under load.			
			Pump flow rate in excess of capacity	Verify system valves are operational and properly set. Contact customer service or sales if pump is sized too small for application.			
High Fluid Temp Fault	17	SC/W	Fluid temperature higher than parameter.	Verify parameter and adjust if necessary.			
			Refrigeration system fault	Check for any refrigeration			

				system fault
			Chiller too small for load	Verify with sales representative the sizing of the chiller for the application.
Low Condenser Differential Pressure Warning	18	W	Low discharge pressure or high suction pressure	Contact customer service
Condenser Inlet Temp Sensor Failure (optional with sensor pack)	19	W	Sensor wires loose from controller terminal block	Verify wiring at terminal block.
			Sensor wires broke between sensor and controller terminal block.	Replace temperature sensor
Chiller In Fluid Temp Sensor Failure	20	W	Sensor wires loose from controller terminal block	Verify wiring at terminal block.
			Sensor wires broke between sensor and controller terminal block.	Replace temperature sensor
Evaporator Differential Pressure	21	W	Blocked evaporator	Backflush evaporator
			Blocked Y-strainer	Blow down y-strainer by opening blow-down valve or clean internal strainer.
High Discharge Pressure Warning	22	W	Dirty air cooled condenser or inlet filter	Clean filter or condenser
			Dirty water cooled condenser or condenser valve failure	Clean condenser or verify operation of condenser valve
			Condenser fan overload	See Fan Overload Fault
			Condenser fan VFD fault	See VFD Fault
			Ambient air or condenser water temperature too high	Verify supply temperature or air removal capacity.
			Too much refrigerant in system.	Contact Customer Service for assistance
High Fluid Temp Warning	23	W	Liquid line valves closed.	Verify operation of valve and wiring on controller
			Fluid temperature higher than parameter.	Verify parameter and adjust if necessary.
			Refrigeration system fault	Check for any refrigeration system fault
			Chiller too small for load	Verify with sales representative the sizing of the chiller for the application.

CC = Compressor Critical	SC = System Critical	PC = Process Critical	W = Warning	
Alarm Name	#	Type	Possible Cause	Solution
High Level Fault	24	W	Fluid level higher than parameter setting.	Verify value in parameter
			Too much fluid in system	Open drain valve and remove some fluid from system so that level is below high level fault.
			Tank sensor failure	Replace sensor
High Level Warning	25	W	Fluid level higher than parameter setting.	Verify value in parameter
			Too much fluid in system	Open drain valve and remove some fluid from system so that level is below high level warning.
			Tank sensor failure	Replace sensor
Compressor Differential Pressure Fault	26	CC	Low discharge pressure or high suction pressure	Contact customer service
High Suction Pressure Warning	27	W	From Process fluid temperature too high	Verify flow through system. Make corrections as necessary.
Low Discharge Pressure Warning	28	W	Ambient air or condenser	Verify ambient air temperature

			water temperature too low	and air flow or condenser inlet water temperature.
			Too little refrigerant in system.	Contact customer service for service call
			Water cooled condenser valve stuck open	Verify cooling valve operation.
			Fan VFD output at 100%	Verify VFD is in remote versus manual operation. Verify controller output to VFD.
Low Fluid Temp Warning	29	W		
Low Level Warning	30	W	Fluid level lower than parameter setting.	Verify value in parameter. Add fluid to the system if necessary
			Optional Water Makeup valve failure	Verify wiring between controller and makeup valve. Replace valve if necessary
			Tank sensor failure	Replace sensor
Compressor Differential Pressure Warning	31	W	Low discharge pressure or high suction pressure	Contact customer service
Low Suction Pressure Warning	32	W	System low on refrigerant	Contact Customer Service
			Liquid line valves closed	Verify wiring or output between controller and valve
			Chilled fluid setpoint too close to freeze protection setpoint.	Adjust setpoint or fluid freeze point temperature (will require adding glycol to fluid)
			Process fluid flow rate too low.	Verify system valve operation and adjust if necessary
			Thermal expansion valve failure.	Contact Customer Service
Pump Down Override Time Expired	33	W	Liquid line valve open	Contact customer service
			Hot gas bypass valve open	

CC = Compressor Critical	SC = System Critical	PC = Process Critical	W = Warning	
Alarm Name	#	Type	Possible Cause	Solution
Pump Flow Sensor Failure	34	W	Optional flow sensor failed	Verify wiring of flow sensor at sensor and terminal block of controller
Pump Pressure Sensor Failure	35	W	Sensor wires loose from controller terminal block	Verify wiring of sensor at sensor and terminal block of controller
			Sensor wires broke between sensor and controller terminal block.	
Refrig Liquid Temp Sensor Failure	36	W	Sensor wires loose from controller terminal block	Verify wiring of sensor at sensor and terminal block of controller
			Sensor wires broke between sensor and controller terminal block.	
Refrig Suction Temp Sensor Failure	37	W	Sensor wires loose from controller terminal block	Verify wiring of sensor at sensor and terminal block of controller
			Sensor wires broke between sensor and controller terminal block.	
Tank Level Sensor Failure	38	W	Sensor wires loose from controller terminal block	Verify wiring of sensor at sensor and terminal block of controller
			Sensor wires broke between sensor and controller terminal block.	
Water make-up failure	40	W	Make up solenoid failure	Verify wiring of solenoid valve at valve and at terminal block.
			Insufficient water pressure	Increase water pressure to be above 5 psig (0.3 bar)

Auxilliary Alarm	41	SC/W	This alarm is configurable	
Low Suction Pressure at Startup	42	CC	Parameter set too short for remote condenser installation	Adjust parameter for length of time to build suction pressure
			Refrigerant amount too low	Contact Customer Service
For Units with a Tempered Loop				
To ProcTemperature Sensor Failure	43	PC	Loose or broken sensor wire	Verify wiring of temperature sensor at sensor and terminal block of controller
Process High Temp Fault	44	W	Process heater on	Verify heater contactor operation
			Process cooling valve off	Verify cooling valve operation
Process High Temp Warning	46	W	Process heater on	Verify heater contactor operation
			Process cooling valve off	Verify cooling valve operation
Process Low Temp Fault	48	W	Process heater off	Verify heater contactor operation
			Process cooling valve on	Verify cooling valve operation
Process Low Temp Warning	50	W	Process heater off	Verify heater contactor operation
			Process cooling valve on	Verify cooling valve operation
Pump 2 No Flow	52	SC/W	Optional process flow switch failure	Verify operation of flow switch.
			Process valves closed	Verify operation of process valves and adjust as necessary

CC = Compressor Critical	SC = System Critical	PC = Process Critical	W = Warning	
Alarm Name	#	Type	Possible Cause	Solution
Pump 2 Overload	53	SC/W	Motor circuit protector open	Verify motor circuit protector operation. Verify motor wiring and amp draw while under load.
			Pump flow rate in excess of capacity	Verify system valves are operational and properly set. Contact customer service or sales if pump is sized too small for application.
High Temp Safety Switch	54	PC	Heater failure	Verify operation of heater and cooling valve. .
			Cooling Valve failure	Verify wiring at cooling valve and at terminal bloc
			Sensor failure	Replace sensor if necessary.
Phase Monitor Fault	55	SC	Unit wired incorrectly	Reverse two wires at line-side of power switch on electrical panel.
			Loss of phase during operation	Verify sensor wiring at sensor and at terminal bloc.
			Sensor failure	Replace sensor if necessary.
From Proc Sensor Failure	56	W	Sensor wires loose from controller terminal block	Verify wiring at sensor and at terminal block. y.
			Sensor wires broke between sensor and controller terminal block.	Replace sensor if necessar

Non-Controller Related Issues

Problem	Possible cause	Solution
Unit does not run.	No power.	Check main disconnect, fuses, wiring, and power lead to unit.
	Wrong voltage supplied to unit.	Voltage must be within plus or minus 10% of nameplate rating.

Problem	Possible cause	Solution
	Control circuit fuse blown.	Replace control circuit fuse.
		Check transformer.
		Check for a short circuit.
	Defective control transformer.	Replace.
	Piping flow switch circuit open.	Add water or water/glycol solution as required.
Pump motor off on overload.	Reset and test.	

Problem	Possible cause	Solution
Pump runs; compressor does not.	Leaving fluid setpoint set higher than temperature of liquid in system.	Lower the leaving fluid temperature below the leaving temperature you desire.
	Compressor internal overload or MCP is open.	Allow time to cool and reset, then check for high/low volt-age. It must be within plus or minus 10% of the nameplate rating.
		Check for loose compressor electrical connections.
		Failed compressor motor
	Compressor contactor holding coil open.	Repair or replace.
	Defective compressor auxiliary contact.	Repair or replace.
Broken wire in the compressor control circuit.	Locate and repair.	
Pump runs, compressor cycles at short intervals.	Plugged Y-strainer	Clean
	Hot gas not coming on	Check hot gas analog output value through status screen. Contact Service if output value remains at 0% throughout compressor cycle.
	Low process water flow	Check internal bypass valve to verify it is open and free of debris. Install bypass between to-and-from process line
Unit runs continuously, but not enough cooling power.	Restricted condenser air flow.	Clean filters.
		Clean condenser.
	Unit low on refrigerant.	Check the refrigerant charge by viewing sight glass on liquid line upstream of the expansion valve.
	Compressor not operating efficiently.	Call service.
Unit under-sized for application.	Call sales rep.	

Chapter 7: Appendix

7-1 Returned Material Policy

Credit Returns

Prior to the return of any material, **authorization** must be given by **the manufacturer**. A RMA number will be assigned for the equipment to be returned.

Reason for requesting the return must be given.

All returned Material purchased from the manufacturer is subject to 15% (\$75.00 minimum) restocking charge.

All returns are to be shipped prepaid.

The invoice number and date or purchase order number and date must be supplied.

No credit will be issued for material that is not within the manufacturer's warranty period and/or in new and unused condition, suitable for resale.

Warranty Returns

Prior to the return of any material, **authorization** must be given by **the manufacturer**. A RMA number will be assigned for the equipment to be returned.

Reason for requesting the return must be given.

All returns are to be shipped prepaid.

The invoice number and date or purchase number and date must be supplied.

After inspecting the material, a replacement or credit will be given, at the **manufacturer's** discretion, if the item is found to be defective in materials or workmanship. Purchased components are covered under their specific warranty terms.

7-2 Technical Assistance

Parts Department

Call toll-free Monday – Friday, 7am–5pm CST [800] 423-3183 or call [262] 641-8610, Fax [262] 641-8653

The ACS Customer Service Group will provide your company with genuine OEM quality parts manufactured to engineering design specifications, which will maximize your equipment's performance and efficiency. To assist in expediting your phone or fax order, please have the model and serial number of your unit when you contact us. A customer replacement parts list is included in this manual for your convenience. ACS welcomes inquiries on all your parts needs and is dedicated to providing excellent customer service.

Service Department

Call toll-free Monday – Friday, 8am–5pm CST [800] 423-3183 or call [262] 641-8610

Emergencies after 5pm CST, call [847] 439-5655

We have a qualified service department ready to help. Service contracts are available for most products.

Sales Department

Call [262] 641-8610 Monday–Friday, 8am–5pm CST

Our products are sold by a world-wide network of independent sales representatives. Contact our Sales Department for the name of the sales representative nearest you.

Contract Department

Call [262] 641-8610 Monday–Friday, 8am–5pm CST

Let us install your system. The Contract Department offers any or all of these services: project planning; system packages including drawings; equipment, labor, and construction materials; and union or non-union installations.

Specifications

Air-Cooled Portable Chillers

Nominal operating parameters for air-cooled models are 50°F (10°C) leaving water temperature at 2.4 gpm per ton (9.1 lpm per 3.517 kW) with 95°F (35°C) ambient air. **For 50 Hz applications**, multiply capacity by **0.83**. *Nominal 60 Hz capacity flow rate must be maintained.*

GPAC-20

PERFORMANCE (NOMINAL DESIGN CONDITIONS)					
COOLING CAPACITY	4.65	TONS	ALTITUDE	SEA LEVEL	
COOLANT SUPPLY TEMPERATURE	50	°F	COMPRESSOR POWER	4936	WATTS
AMBIENT AIR TEMPERATURE	95	°F	EER	11.31	BTU/WATT
COOLANT	WATER		CONDENSER AIR FLOW	4230	CFM
COOLANT FLOW	11	GPM	SOUND POWER LEVEL	86	dB
UNIT PRESSURE DROP	7	PSID	SOUND PRESSURE LEVEL @ 1 METER		dB
OPERATING PARAMETERS					
COOLANT SUPPLY TEMPERATURE	20-80	°F	COOLANT FLOW	6-24	GPM
AMBIENT AIR TEMPERATURE	60-115	°F	MINIMUM LOAD	0.944	TONS
SPECIFICATIONS					
COMPRESSOR	SCROLL		EVAPORATOR FILTER	20 MESH	
COOLANT PUMP	STAINLESS STEEL CENTRIFUGAL		COOLANT CIRCUIT	NON-FERROUS	
EVAPORATOR	BRAZED PLATE		CAPACITY CONTROL	HOT GAS BYPASS	
CONDENSER	ALUMINUM		REFRIGERANT	3 LBS R-410A	
CONDENSER FANS	24 INCH AXIAL		FRAME	GALVANIZED STEEL	
CONDENSER FAN MOTOR	1/2 HP OAO, 1140 RPM		PANELS	POWDER COATED STEEL	
RESERVOIR	20 GALLON POLYETHYLENE		WEIGHT (OPERATING)	690	LBS
POWER	460V/3PH/60HZ		WEIGHT (SHIPPING)	520	LBS
CONTROL CIRCUIT	120	VDC	ELECTRICAL ENCLOSURE	NEMA 12	
COMPRESSOR FULL LOAD AMPS	10.7	AMPS	CONTROL	MICROPROCESSOR	

GPAC-30

PERFORMANCE (NOMINAL DESIGN CONDITIONS)					
COOLING CAPACITY	7.30	TONS	ALTITUDE	SEA LEVEL	
COOLANT SUPPLY TEMPERATURE	50	°F	COMPRESSOR POWER	7579	WATTS
AMBIENT AIR TEMPERATURE	95	°F	EER	11.56	BTU/WATT
COOLANT	WATER		CONDENSER AIR FLOW	6343	CFM
COOLANT FLOW	18	GPM	SOUND POWER LEVEL	92	dB
UNIT PRESSURE DROP	7	PSID	SOUND PRESSURE LEVEL @ 1 METER		dB
OPERATING PARAMETERS					
COOLANT SUPPLY TEMPERATURE	20-80	°F	COOLANT FLOW	9-36	GPM
AMBIENT AIR TEMPERATURE	60-115	°F	MINIMUM LOAD	1.504	TONS
SPECIFICATIONS					
COMPRESSOR	SCROLL		EVAPORATOR FILTER	20 MESH	
COOLANT PUMP	STAINLESS STEEL CENTRIFUGAL		COOLANT CIRCUIT	NON-FERROUS	
EVAPORATOR	BRAZED PLATE		CAPACITY CONTROL	HOT GAS BYPASS	
CONDENSER	ALUMINUM		REFRIGERANT	4 LBS R-410A	
CONDENSER FANS	24 INCH AXIAL		FRAME	GALVANIZED STEEL	
CONDENSER FAN MOTOR	1 HP OAO, 1140 RPM		PANELS	POWDER COATED STEEL	
RESERVOIR	20 GALLON POLYETHYLENE		WEIGHT (OPERATING)	870	LBS
POWER	460V/3PH/60HZ		WEIGHT (SHIPPING)	700	LBS
CONTROL CIRCUIT	120	VDC	ELECTRICAL ENCLOSURE	NEMA 12	
COMPRESSOR FULL LOAD AMPS	16.4	AMPS	CONTROL	MICROPROCESSOR	

GPAC-40

PERFORMANCE (NOMINAL DESIGN CONDITIONS)					
COOLING CAPACITY	9.91	TONS	ALTITUDE	SEA LEVEL	
COOLANT SUPPLY TEMPERATURE	50	°F	COMPRESSOR POWER	10070	WATTS
AMBIENT AIR TEMPERATURE	95	°F	EER	11.81	BTU/WATT
COOLANT	WATER		CONDENSER AIR FLOW	8458	CFM
COOLANT FLOW	24	GPM	SOUND POWER LEVEL	87	dB
UNIT PRESSURE DROP	7	PSID	SOUND PRESSURE LEVEL @ 1 METER		dB
OPERATING PARAMETERS					
COOLANT SUPPLY TEMPERATURE	20-80	°F	COOLANT FLOW	12-48	GPM
AMBIENT AIR TEMPERATURE	60-115	°F	MINIMUM LOAD	2.022	TONS
SPECIFICATIONS					
COMPRESSOR	SCROLL		EVAPORATOR FILTER	20 MESH	
COOLANT PUMP	STAINLESS STEEL CENTRIFUGAL		COOLANT CIRCUIT	NON-FERROUS	
EVAPORATOR	BRAZED PLATE		CAPACITY CONTROL	HOT GAS BYPASS	
CONDENSER	ALUMINUM		REFRIGERANT	6 LBS R-410A	
CONDENSER FANS	32 INCH AXIAL		FRAME	GALVANIZED STEEL	
CONDENSER FAN MOTOR	1 HP OAO, 1140 RPM		PANELS	POWDER COATED STEEL	
RESERVOIR	40 GALLON POLYETHYLENE		WEIGHT (OPERATING)	1090	LBS
POWER	460V/3PH/60HZ		WEIGHT (SHIPPING)	760	LBS
CONTROL CIRCUIT	120	VDC	ELECTRICAL ENCLOSURE	NEMA 12	
COMPRESSOR FULL LOAD AMPS	20	AMPS	CONTROL	MICROPROCESSOR	

GPAC-50

PERFORMANCE (NOMINAL DESIGN CONDITIONS)					
COOLING CAPACITY	15.19	TONS	ALTITUDE	SEA LEVEL	
COOLANT SUPPLY TEMPERATURE	50	°F	COMPRESSOR POWER	14882	WATTS
AMBIENT AIR TEMPERATURE	95	°F	EER	12.25	BTU/WATT
COOLANT	WATER		CONDENSER AIR FLOW	12687	CFM
COOLANT FLOW	36	GPM	SOUND POWER LEVEL	93	dB
UNIT PRESSURE DROP	7	PSID	SOUND PRESSURE LEVEL @ 1 METER		dB
OPERATING PARAMETERS					
COOLANT SUPPLY TEMPERATURE	20-80	°F	COOLANT FLOW	18-72	GPM
AMBIENT AIR TEMPERATURE	60-115	°F	MINIMUM LOAD	3.016	TONS
SPECIFICATIONS					
COMPRESSOR	SCROLL		EVAPORATOR FILTER	20 MESH	
COOLANT PUMP	STAINLESS STEEL CENTRIFUGAL		COOLANT CIRCUIT	NON-FERROUS	
EVAPORATOR	BRAZED PLATE		CAPACITY CONTROL	HOT GAS BYPASS	
CONDENSER	ALUMINUM		REFRIGERANT	8 LBS R-410A	
CONDENSER FANS	32 INCH AXIAL		FRAME	GALVANIZED STEEL	
CONDENSER FAN MOTOR	2 HP OAO, 1140 RPM		PANELS	POWDER COATED STEEL	
RESERVOIR	40 GALLON POLYETHYLENE		WEIGHT (OPERATING)	1290	LBS
POWER	460V/3PH/60HZ		WEIGHT (SHIPPING)	950	LBS
CONTROL CIRCUIT	120	VDC	ELECTRICAL ENCLOSURE	NEMA 12	
COMPRESSOR FULL LOAD AMPS	30	AMPS	CONTROL	MICROPROCESSOR	

GPAC-70

PERFORMANCE (NOMINAL DESIGN CONDITIONS)					
COOLING CAPACITY	20.16	TONS	ALTITUDE	SEA LEVEL	
COOLANT SUPPLY TEMPERATURE	50	°F	COMPRESSOR POWER	20048	WATTS
AMBIENT AIR TEMPERATURE	95	°F	EER	12.07	BTU/WATT
COOLANT	WATER		CONDENSER AIR FLOW	16916	CFM
COOLANT FLOW	48	GPM	SOUND POWER LEVEL	89	dBA
UNIT PRESSURE DROP	7	PSID	SOUND PRESS LEVEL @ 1 METER		dBA
OPERATING PARAMETERS					
COOLANT SUPPLY TEMPERATURE	20-80	°F	COOLANT FLOW	24-96	GPM
AMBIENT AIR TEMPERATURE	60-115	°F	MINIMUM LOAD	4.03	TONS
SPECIFICATIONS					
COMPRESSOR	SCROLL		EVAPORATOR FILTER	20 MESH	
COOLANT PUMP	STAINLESS STEEL CENTRIFUGAL		COOLANT CIRCUIT	NON-FERROUS	
EVAPORATOR	BRAZED PLATE		CAPACITY CONTROL	HOT GAS BYPASS	
CONDENSER	ALUMINUM		REFRIGERANT	12 LBS R-410A	
CONDENSER FANS	(2) 24 INCH AXIAL		FRAME	GALVANIZED STEEL	
CONDENSER FAN MOTOR	(2) 1/2 HP OAO, 1140 RPM		PANELS	POWDER COATED STEEL	
RESERVOIR	70 GALLON POLYETHYLENE		WEIGHT (OPERATING)	2180	LBS
POWER	460V/3PH/60HZ		WEIGHT (SHIPPING)	1520	LBS
CONTROL CIRCUIT	24/120	VAC	ELECTRICAL ENCLOSURE	NEMA 12	
COMPRESSOR RATED LOAD AMPS	(2) @ 17.9 AMPS EACH		CONTROL	MICROPROCESSOR	

GPAC-90

PERFORMANCE (NOMINAL DESIGN CONDITIONS)					
COOLING CAPACITY	25.47	TONS	ALTITUDE	SEA LEVEL	
COOLANT SUPPLY TEMPERATURE	50	°F	COMPRESSOR POWER	25504	WATTS
AMBIENT AIR TEMPERATURE	95	°F	EER	11.98	BTU/WATT
COOLANT	WATER		CONDENSER AIR FLOW	25374	CFM
COOLANT FLOW	61	GPM	SOUND POWER LEVEL	95	dBA
UNIT PRESSURE DROP	7	PSID	SOUND PRESS LEVEL @ 1 METER		dBA
OPERATING PARAMETERS					
COOLANT SUPPLY TEMPERATURE	20-80	°F	COOLANT FLOW	30-120	GPM
AMBIENT AIR TEMPERATURE	60-115	°F	MINIMUM LOAD	5.09	TONS
SPECIFICATIONS					
COMPRESSOR	SCROLL		EVAPORATOR FILTER	20 MESH	
COOLANT PUMP	STAINLESS STEEL CENTRIFUGAL		COOLANT CIRCUIT	NON-FERROUS	
EVAPORATOR	BRAZED PLATE		CAPACITY CONTROL	HOT GAS BYPASS	
CONDENSER	ALUMINUM		REFRIGERANT	12 LBS R-410A	
CONDENSER FANS	(2) 32 INCH AXIAL		FRAME	GALVANIZED STEEL	
CONDENSER FAN MOTOR	(2) 2 HP OAO, 1140 RPM		PANELS	POWDER COATED STEEL	
RESERVOIR	70 GALLON POLYETHYLENE		WEIGHT (OPERATING)	2580	LBS
POWER	460V/3PH/60HZ		WEIGHT (SHIPPING)	1900	LBS
CONTROL CIRCUIT	24/120	VAC	ELECTRICAL ENCLOSURE	NEMA 12	
COMPRESSOR RATED LOAD AMPS	(2) @ 23.1 AMPS EACH		CONTROL	MICROPROCESSOR	

GPAC-105

PERFORMANCE (NOMINAL DESIGN CONDITIONS)					
COOLING CAPACITY	30.21	TONS	ALTITUDE	SEA LEVEL	
COOLANT SUPPLY TEMPERATURE	50	°F	COMPRESSOR POWER	29731	WATTS
AMBIENT AIR TEMPERATURE	95	°F	EER	12.19	BTU/WATT
COOLANT	WATER		CONDENSER AIR FLOW	25374	CFM
COOLANT FLOW	72	GPM	SOUND POWER LEVEL	95	dBA
UNIT PRESSURE DROP	7	PSID	SOUND PRESS LEVEL @ 1 METER		dBA
OPERATING PARAMETERS					
COOLANT SUPPLY TEMPERATURE	20-80	°F	COOLANT FLOW	36-144	GPM
AMBIENT AIR TEMPERATURE	60-115	°F	MINIMUM LOAD	6.04	TONS
SPECIFICATIONS					
COMPRESSOR	SCROLL		EVAPORATOR FILTER	20 MESH	
COOLANT PUMP	STAINLESS STEEL CENTRIFUGAL		COOLANT CIRCUIT	NON-FERROUS	
EVAPORATOR	BRAZED PLATE		CAPACITY CONTROL	HOT GAS BYPASS	
CONDENSER	ALUMINUM		REFRIGERANT	16 LBS R-410A	
CONDENSER FANS	(2) 32 INCH AXIAL		FRAME	GALVANIZED STEEL	
CONDENSER FAN MOTOR	(2) 2 HP OAO, 1140 RPM		PANELS	POWDER COATED STEEL	
RESERVOIR	70 GALLON POLYETHYLENE		WEIGHT (OPERATING)	2580	LBS
POWER	460V/3PH/60HZ		WEIGHT (SHIPPING)	1900	LBS
CONTROL CIRCUIT	24/120	VAC	ELECTRICAL ENCLOSURE	NEMA 12	
COMPRESSOR RATED LOAD AMPS	(2) @ 26.9 AMPS EACH		CONTROL	MICROPROCESSOR	

GPAC-140

PERFORMANCE (NOMINAL DESIGN CONDITIONS)					
COOLING CAPACITY	40	TONS	ALTITUDE	SEA LEVEL	
COOLANT SUPPLY TEMPERATURE	50	°F	COMPRESSOR POWER	38153	WATTS
AMBIENT AIR TEMPERATURE	95	°F	EER	12.58	BTU/WATT
COOLANT	WATER		CONDENSER AIR FLOW	38061	CFM
COOLANT FLOW	96	GPM	SOUND POWER LEVEL	98	dBA
UNIT PRESSURE DROP	7	PSID	SOUND PRESS LEVEL @ 1 METER		dBA
OPERATING PARAMETERS					
COOLANT SUPPLY TEMPERATURE	20-80	°F	COOLANT FLOW	48-192	GPM
AMBIENT AIR TEMPERATURE	60-115	°F	MINIMUM LOAD	8.00	TONS
SPECIFICATIONS					
COMPRESSOR	SCROLL		EVAPORATOR FILTER	20 MESH	
COOLANT PUMP	STAINLESS STEEL CENTRIFUGAL		COOLANT CIRCUIT	NON-FERROUS	
EVAPORATOR	BRAZED PLATE		CAPACITY CONTROL	HOT GAS BYPASS	
CONDENSER	ALUMINUM		REFRIGERANT	18 LBS R-410A	
CONDENSER FANS	(3) 32 INCH AXIAL		FRAME	GALVANIZED STEEL	
CONDENSER FAN MOTOR	(3) 2 HP OAO, 1140 RPM		PANELS	POWDER COATED STEEL	
RESERVOIR	140 GALLON POLYETHYLENE		WEIGHT (OPERATING)	3870	LBS
POWER	460V/3PH/60HZ		WEIGHT (SHIPPING)	2850	LBS
CONTROL CIRCUIT	24/120	VAC	ELECTRICAL ENCLOSURE	NEMA 12	
COMPRESSOR RATED LOAD AMPS	(2) @ 30.4 AMPS EACH		CONTROL	MICROPROCESSOR	

GPAC-175

PERFORMANCE (NOMINAL DESIGN CONDITIONS)					
COOLING CAPACITY	49.41	TONS	ALTITUDE	SEA LEVEL	
COOLANT SUPPLY TEMPERATURE	50	°F	COMPRESSOR POWER	48693	WATTS
AMBIENT AIR TEMPERATURE	95	°F	EER	12.18	BTU/WATT
COOLANT	WATER		CONDENSER AIR FLOW	38061	CFM
COOLANT FLOW	118	GPM	SOUND POWER LEVEL	98	dba
UNIT PRESSURE DROP	7	PSID	SOUND PRESS LEVEL @ 1 METER		dba
OPERATING PARAMETERS					
COOLANT SUPPLY TEMPERATURE	20-80	°F	COOLANT FLOW	60-240	GPM
AMBIENT AIR TEMPERATURE	60-115	°F	MINIMUM LOAD	9.88	TONS
SPECIFICATIONS					
COMPRESSOR	SCROLL		EVAPORATOR FILTER	20 MESH	
COOLANT PUMP	STAINLESS STEEL CENTRIFUGAL		COOLANT CIRCUIT	NON-FERROUS	
EVAPORATOR	BRAZED PLATE		CAPACITY CONTROL	HOT GAS BYPASS	
CONDENSER	ALUMINUM		REFRIGERANT	24 LBS R-410A	
CONDENSER FANS	(3) 32 INCH AXIAL		FRAME	GALVANIZED STEEL	
CONDENSER FAN MOTOR	(3) 2 HP OAO, 1140 RPM		PANELS	POWDER COATED STEEL	
RESERVOIR	140 GALLON POLYETHYLENE		WEIGHT (OPERATING)	3870	LBS
POWER	460V/3PH/60HZ		WEIGHT (SHIPPING)	2850	LBS
CONTROL CIRCUIT	24/120	VAC	ELECTRICAL ENCLOSURE	NEMA 12	
COMPRESSOR RATED LOAD AMPS	(2) @ 41.9 AMPS EACH		CONTROL	MICROPROCESSOR	

GPAC-210

PERFORMANCE (NOMINAL DESIGN CONDITIONS)					
COOLING CAPACITY	63.95	TONS	ALTITUDE	SEA LEVEL	
COOLANT SUPPLY TEMPERATURE	50	°F	COMPRESSOR POWER	63589	WATTS
AMBIENT AIR TEMPERATURE	95	°F	EER	12.07	BTU/WATT
COOLANT	WATER		CONDENSER AIR FLOW	50748	CFM
COOLANT FLOW	153	GPM	SOUND POWER LEVEL	99	dba
UNIT PRESSURE DROP	7	PSID	SOUND PRESS LEVEL @ 1 METER		dba
OPERATING PARAMETERS					
COOLANT SUPPLY TEMPERATURE	20-80	°F	COOLANT FLOW	72-288	GPM
AMBIENT AIR TEMPERATURE	60-115	°F	MINIMUM LOAD	12.79	TONS
SPECIFICATIONS					
COMPRESSOR	SCROLL		EVAPORATOR FILTER	20 MESH	
COOLANT PUMP	STAINLESS STEEL CENTRIFUGAL		COOLANT CIRCUIT	NON-FERROUS	
EVAPORATOR	BRAZED PLATE		CAPACITY CONTROL	HOT GAS BYPASS	
CONDENSER	ALUMINUM		REFRIGERANT	32 LBS R-410A	
CONDENSER FANS	(4) 32 INCH AXIAL		FRAME	GALVANIZED STEEL	
CONDENSER FAN MOTOR	(4) 2 HP OAO, 1140 RPM		PANELS	POWDER COATED STEEL	
RESERVOIR	140 GALLON POLYETHYLENE		WEIGHT (OPERATING)	5160	LBS
POWER	460V/3PH/60HZ		WEIGHT (SHIPPING)	3800	LBS
CONTROL CIRCUIT	24/120	VAC	ELECTRICAL ENCLOSURE	NEMA 12	
COMPRESSOR RATED LOAD AMPS	(2) @ 54.5 AMPS EACH		CONTROL	MICROPROCESSOR	

Water-Cooled Portable Chillers

Nominal operating parameters for water-cooled models are 50°F (10°C) leaving water temperature at 2.4 gpm per ton (9.1 lpm per 3.517 kW) with 85°F (29°C) tower water. **For 50 Hz applications**, multiply capacity by **0.83**. *Nominal 60 Hz capacity flow rate must be maintained.*

GPWC-20

PERFORMANCE (NOMINAL DESIGN CONDITIONS, 60 HZ)					
COOLING CAPACITY	5.12	TONS	ALTITUDE	SEA LEVEL	
COOLANT SUPPLY TEMPERATURE	50	°F	COMPRESSOR POWER	4064	WATTS
CONDENSER INLET WATER TEMPERATURE	85	°F	EER	15.13	BTU/WATT
COOLANT	WATER		CONDENSER WATER FLOW	15.9	GPM
COOLANT FLOW	13	GPM	SOUND POWER LEVEL		dB
UNIT PRESSURE DROP	7	PSID	SOUND PRESSURE LEVEL @ 1 METER		dB
OPERATING PARAMETERS					
COOLANT SUPPLY TEMPERATURE	20-80	°F	COOLANT FLOW	6-24	GPM
CONDENSER INLET WATER TEMPERATURE	50-90	°F	MINIMUM LOAD	1.06	TONS
SPECIFICATIONS					
COMPRESSOR	SCROLL		EVAPORATOR FILTER	20 MESH	
COOLANT PUMP	STAINLESS STEEL CENTRIFUGAL		COOLANT CIRCUIT	NON-FERROUS	
EVAPORATOR	BRAZED PLATE		CAPACITY CONTROL	HOT GAS BYPASS	
CONDENSER	TUBE IN TUBE		REFRIGERANT	3 LBS R-410A	
			FRAME	GALVANIZED STEEL	
			PANELS	POWDER COATED STEEL	
RESERVOIR	20 GALLON POLYETHYLENE		WEIGHT (OPERATING)	690	LBS
POWER	460V/3PH/60HZ		WEIGHT (SHIPPING)	520	LBS
CONTROL CIRCUIT	120	VDC	ELECTRICAL ENCLOSURE	NEMA 12	
COMPRESSOR FULL LOAD AMPS	10.7	AMPS	CONTROL	MICROPROCESSOR	

GPWC-30

PERFORMANCE (NOMINAL DESIGN CONDITIONS)					
COOLING CAPACITY	7.98	TONS	ALTITUDE	SEA LEVEL	
COOLANT SUPPLY TEMPERATURE	50	°F	COMPRESSOR POWER	6416	WATTS
CONDENSER INLET WATER TEMPERATURE	85	°F	EER	14.92	BTU/WATT
COOLANT	WATER		CONDENSER WATER FLOW	25.08	GPM
COOLANT FLOW	20	GPM	SOUND POWER LEVEL		dB
UNIT PRESSURE DROP	7	PSID	SOUND PRESSURE LEVEL @ 1 METER		dB
OPERATING PARAMETERS					
COOLANT SUPPLY TEMPERATURE	20-80	°F	COOLANT FLOW	9-36	GPM
CONDENSER INLET WATER TEMPERATURE	50-90	°F	MINIMUM LOAD	1.672	TONS
SPECIFICATIONS					
COMPRESSOR	SCROLL		EVAPORATOR FILTER	20 MESH	
COOLANT PUMP	STAINLESS STEEL CENTRIFUGAL		COOLANT CIRCUIT	NON-FERROUS	
EVAPORATOR	BRAZED PLATE		CAPACITY CONTROL	HOT GAS BYPASS	
CONDENSER	TUBE IN TUBE		REFRIGERANT	4 LBS R-410A	
			FRAME	GALVANIZED STEEL	
			PANELS	POWDER COATED STEEL	
RESERVOIR	20 GALLON POLYETHYLENE		WEIGHT (OPERATING)	870	LBS
POWER	460V/3PH/60HZ		WEIGHT (SHIPPING)	700	LBS
CONTROL CIRCUIT	120	VDC	ELECTRICAL ENCLOSURE	NEMA 12	
COMPRESSOR FULL LOAD AMPS	16.4	AMPS	CONTROL	MICROPROCESSOR	

GPWC-40

PERFORMANCE (NOMINAL DESIGN CONDITIONS)					
COOLING CAPACITY	10.94	TONS	ALTITUDE	SEA LEVEL	
COOLANT SUPPLY TEMPERATURE	50	°F	COMPRESSOR POWER	8450	WATTS
CONDENSER INLET WATER TEMPERATURE	85	°F	EER	15.53	BTU/WATT
COOLANT	WATER		CONDENSER WATER FLOW	33.93	GPM
COOLANT FLOW	27	GPM	SOUND POWER LEVEL		dB
UNIT PRESSURE DROP	7	PSID	SOUND PRESSURE LEVEL @ 1 METER	dBA	
OPERATING PARAMETERS					
COOLANT SUPPLY TEMPERATURE	20-80	°F	COOLANT FLOW	12-48	GPM
CONDENSER INLET WATER TEMPERATURE	50-90	°F	MINIMUM LOAD	2.262	TONS
SPECIFICATIONS					
COMPRESSOR	SCROLL		EVAPORATOR FILTER	20 MESH	
COOLANT PUMP	STAINLESS STEEL CENTRIFUGAL		COOLANT CIRCUIT	NON-FERROUS	
EVAPORATOR	BRAZED PLATE		CAPACITY CONTROL	HOT GAS BYPASS	
CONDENSER	TUBE IN TUBE		REFRIGERANT	6 LBS R-410A	
			FRAME	GALVANIZED STEEL	
			PANELS	POWDER COATED STEEL	
RESERVOIR	40 GALLON POLYETHYLENE		WEIGHT (OPERATING)	1090	LBS
POWER	460V/3PH/60HZ		WEIGHT (SHIPPING)	760	LBS
CONTROL CIRCUIT	120	VDC	ELECTRICAL ENCLOSURE	NEMA 12	
COMPRESSOR FULL LOAD AMPS	20	AMPS	CONTROL	MICROPROCESSOR	

GPWC-50

PERFORMANCE (NOMINAL DESIGN CONDITIONS)					
COOLING CAPACITY	16.66	TONS	ALTITUDE	SEA LEVEL	
COOLANT SUPPLY TEMPERATURE	50	°F	COMPRESSOR POWER	12778	WATTS
CONDENSER INLET WATER TEMPERATURE	85	°F	EER	15.65	BTU/WATT
COOLANT	WATER		CONDENSER WATER FLOW	50.28	GPM
COOLANT FLOW	40	GPM	SOUND POWER LEVEL		dB
UNIT PRESSURE DROP	7	PSID	SOUND PRESSURE LEVEL @ 1 METER	dBA	
OPERATING PARAMETERS					
COOLANT SUPPLY TEMPERATURE	20-80	°F	COOLANT FLOW	18-72	GPM
CONDENSER INLET WATER TEMPERATURE	50-90	°F	MINIMUM LOAD	3.352	TONS
SPECIFICATIONS					
COMPRESSOR	SCROLL		EVAPORATOR FILTER	20 MESH	
COOLANT PUMP	STAINLESS STEEL CENTRIFUGAL		COOLANT CIRCUIT	NON-FERROUS	
EVAPORATOR	BRAZED PLATE		CAPACITY CONTROL	HOT GAS BYPASS	
CONDENSER	TUBE IN TUBE		REFRIGERANT	8 LBS R-410A	
			FRAME	GALVANIZED STEEL	
			PANELS	POWDER COATED STEEL	
RESERVOIR	40 GALLON POLYETHYLENE		WEIGHT (OPERATING)	1290	LBS
POWER	460V/3PH/60HZ		WEIGHT (SHIPPING)	950	LBS
CONTROL CIRCUIT	120	VDC	ELECTRICAL ENCLOSURE	NEMA 12	
COMPRESSOR FULL LOAD AMPS	30	AMPS	CONTROL	MICROPROCESSOR	

GPWC-70

PERFORMANCE (NOMINAL DESIGN CONDITIONS)					
COOLING CAPACITY	22.68	TONS	ALTITUDE	SEA LEVEL	
COOLANT SUPPLY TEMPERATURE	50	°F	COMPRESSOR POWER	16970	WATTS
CONDENSER INLET WATER TEMP	85	°F	EER	16.04	BTU/WATT
COOLANT	WATER		CONDENSER WATER FLOW	68	GPM
COOLANT FLOW	54	GPM	SOUND POWER LEVEL	74	dBA
UNIT PRESSURE DROP	7	PSID	SOUND PRESS LEVEL @ 1 METER		dBA
OPERATING PARAMETERS					
COOLANT SUPPLY TEMPERATURE	20-80	°F	COOLANT FLOW	24-96	GPM
CONDENSER INLET WATER TEMP	50-90	°F	MINIMUM LOAD	4.54	TONS
SPECIFICATIONS					
COMPRESSOR	SCROLL		EVAPORATOR FILTER	20 MESH	
COOLANT PUMP	SST CENTRIFUGAL		COOLANT CIRCUIT	NON-FERROUS	
EVAPORATOR	BRAZED PLATE		CAPACITY CONTROL	HOT GAS BYPASS	
CONDENSER	SHELL & TUBE		REFRIGERANT	12 LBS R-410A	
			FRAME	GALVANIZED STEEL	
			PANELS	POWDER COATED STEEL	
RESERVOIR	70 GALLON POLYETHYLENE		WEIGHT (OPERATING)	2180	LBS
POWER	460V/3PH/60HZ		WEIGHT (SHIPPING)	1520	LBS
CONTROL CIRCUIT	24/120	VAC	ELECTRICAL ENCLOSURE	NEMA 12	
COMPRESSOR RATED LOAD AMPS	(2) @ 17.9 AMPS EACH		CONTROL	MICROPROCESSOR	

GPWC-90

PERFORMANCE (NOMINAL DESIGN CONDITIONS)					
COOLING CAPACITY	28.43	TONS	ALTITUDE	SEA LEVEL	
COOLANT SUPPLY TEMPERATURE	50	°F	COMPRESSOR POWER	21716	WATTS
CONDENSER INLET WATER TEMP	85	°F	EER	15.71	BTU/WATT
COOLANT	WATER		CONDENSER WATER FLOW	85	GPM
COOLANT FLOW	68	GPM	SOUND POWER LEVEL	74	dBA
UNIT PRESSURE DROP	7	PSID	SOUND PRESS LEVEL @ 1 METER		dBA
OPERATING PARAMETERS					
COOLANT SUPPLY TEMPERATURE	20-80	°F	COOLANT FLOW	30-120	GPM
CONDENSER INLET WATER TEMP	50-90	°F	MINIMUM LOAD	5.69	TONS
SPECIFICATIONS					
COMPRESSOR	SCROLL		EVAPORATOR FILTER	20 MESH	
COOLANT PUMP	SST CENTRIFUGAL		COOLANT CIRCUIT	NON-FERROUS	
EVAPORATOR	BRAZED PLATE		CAPACITY CONTROL	HOT GAS BYPASS	
CONDENSER	SHELL & TUBE		REFRIGERANT	12 LBS R-410A	
			FRAME	GALVANIZED STEEL	
			PANELS	POWDER COATED STEEL	
RESERVOIR	70 GALLON POLYETHYLENE		WEIGHT (OPERATING)	2580	LBS
POWER	460V/3PH/60HZ		WEIGHT (SHIPPING)	1900	LBS
CONTROL CIRCUIT	24/120	VAC	ELECTRICAL ENCLOSURE	NEMA 12	
COMPRESSOR RATED LOAD AMPS	(2) @ 23.1 AMPS EACH		CONTROL	MICROPROCESSOR	

GPWC-105

PERFORMANCE (NOMINAL DESIGN CONDITIONS)					
COOLING CAPACITY	33.64	TONS	ALTITUDE	SEA LEVEL	
COOLANT SUPPLY TEMPERATURE	50	°F	COMPRESSOR POWER	25508	WATTS
CONDENSER INLET WATER TEMP	85	°F	EER	15.83	BTU/WATT
COOLANT	WATER		CONDENSER WATER FLOW	101	GPM
COOLANT FLOW	80	GPM	SOUND POWER LEVEL	76	dba
UNIT PRESSURE DROP	7	PSID	SOUND PRESS LEVEL @ 1 METER		dba
OPERATING PARAMETERS					
COOLANT SUPPLY TEMPERATURE	20-80	°F	COOLANT FLOW	36-144	GPM
CONDENSER INLET WATER TEMP	50-90	°F	MINIMUM LOAD	6.73	TONS
SPECIFICATIONS					
COMPRESSOR	SCROLL		EVAPORATOR FILTER	20 MESH	
COOLANT PUMP	SST CENTRIFUGAL		COOLANT CIRCUIT	NON-FERROUS	
EVAPORATOR	BRAZED PLATE		CAPACITY CONTROL	HOT GAS BYPASS	
CONDENSER	SHELL & TUBE		REFRIGERANT	16 LBS R-410A	
			FRAME	GALVANIZED STEEL	
			PANELS	POWDER COATED STEEL	
RESERVOIR	70 GALLON POLYETHYLENE		WEIGHT (OPERATING)	2580	LBS
POWER	460V/3PH/60HZ		WEIGHT (SHIPPING)	1900	LBS
CONTROL CIRCUIT	24/120	VAC	ELECTRICAL ENCLOSURE	NEMA 12	
COMPRESSOR RATED LOAD AMPS	(2) @ 26.9 AMPS EACH		CONTROL	MICROPROCESSOR	

GPWC-140

PERFORMANCE (NOMINAL DESIGN CONDITIONS)					
COOLING CAPACITY	43.35	TONS	ALTITUDE	SEA LEVEL	
COOLANT SUPPLY TEMPERATURE	50	°F	COMPRESSOR POWER	32685	WATTS
CONDENSER INLET WATER TEMP	85	°F	EER	15.92	BTU/WATT
COOLANT	WATER		CONDENSER WATER FLOW	130	GPM
COOLANT FLOW	104	GPM	SOUND POWER LEVEL	79	dba
UNIT PRESSURE DROP	7	PSID	SOUND PRESS LEVEL @ 1 METER		dba
OPERATING PARAMETERS					
COOLANT SUPPLY TEMPERATURE	20-80	°F	COOLANT FLOW	48-192	GPM
CONDENSER INLET WATER TEMP	50-90	°F	MINIMUM LOAD	8.67	TONS
SPECIFICATIONS					
COMPRESSOR	SCROLL		EVAPORATOR FILTER	20 MESH	
COOLANT PUMP	SST CENTRIFUGAL		COOLANT CIRCUIT	NON-FERROUS	
EVAPORATOR	BRAZED PLATE		CAPACITY CONTROL	HOT GAS BYPASS	
CONDENSER	SHELL & TUBE		REFRIGERANT	18 LBS R-410A	
			FRAME	GALVANIZED STEEL	
			PANELS	POWDER COATED STEEL	
RESERVOIR	140 GALLON POLYETHYLENE		WEIGHT (OPERATING)	3870	LBS
POWER	460V/3PH/60HZ		WEIGHT (SHIPPING)	2850	LBS
CONTROL CIRCUIT	24/120	VAC	ELECTRICAL ENCLOSURE	NEMA 12	
COMPRESSOR RATED LOAD AMPS	(2) @ 30.4 AMPS EACH		CONTROL	MICROPROCESSOR	

GPWC-175

PERFORMANCE (NOMINAL DESIGN CONDITIONS)					
COOLING CAPACITY	54.46	TONS	ALTITUDE	SEA LEVEL	
COOLANT SUPPLY TEMPERATURE	50	°F	COMPRESSOR POWER	41633	WATTS
CONDENSER INLET WATER TEMP	85	°F	EER	15.70	BTU/WATT
COOLANT	WATER		CONDENSER WATER FLOW	163	GPM
COOLANT FLOW	130	GPM	SOUND POWER LEVEL	82	dba
UNIT PRESSURE DROP	7	PSID	SOUND PRESS LEVEL @ 1 METER		dba
OPERATING PARAMETERS					
COOLANT SUPPLY TEMPERATURE	20-80	°F	COOLANT FLOW	60-240	GPM
CONDENSER INLET WATER TEMP	50-90	°F	MINIMUM LOAD	10.89	TONS
SPECIFICATIONS					
COMPRESSOR	SCROLL		EVAPORATOR FILTER	20 MESH	
COOLANT PUMP	SST CENTRIFUGAL		COOLANT CIRCUIT	NON-FERROUS	
EVAPORATOR	BRAZED PLATE		CAPACITY CONTROL	HOT GAS BYPASS	
CONDENSER	SHELL & TUBE		REFRIGERANT	24 LBS R-410A	
			FRAME	GALVANIZED STEEL	
			PANELS	POWDER COATED STEEL	
RESERVOIR	140 GALLON POLYETHYLENE		WEIGHT (OPERATING)	3870	LBS
POWER	460V/3PH/60HZ		WEIGHT (SHIPPING)	2850	LBS
CONTROL CIRCUIT	24/120	VAC	ELECTRICAL ENCLOSURE	NEMA 12	
COMPRESSOR RATED LOAD AMPS	(2) @ 41.9 AMPS EACH		CONTROL	MICROPROCESSOR	

GPWC-210

PERFORMANCE (NOMINAL DESIGN CONDITIONS)					
COOLING CAPACITY	70.63	TONS	ALTITUDE	SEA LEVEL	
COOLANT SUPPLY TEMPERATURE	50	°F	COMPRESSOR POWER	54315	WATTS
CONDENSER INLET WATER TEMP	85	°F	EER	15.60	BTU/WATT
COOLANT	WATER		CONDENSER WATER FLOW	212	GPM
COOLANT FLOW	169	GPM	SOUND POWER LEVEL	81	dba
UNIT PRESSURE DROP	7	PSID	SOUND PRESS LEVEL @ 1 METER		dba
OPERATING PARAMETERS					
COOLANT SUPPLY TEMPERATURE	20-80	°F	COOLANT FLOW	72-288	GPM
CONDENSER INLET WATER TEMP	50-90	°F	MINIMUM LOAD	14.13	TONS
SPECIFICATIONS					
COMPRESSOR	SCROLL		EVAPORATOR FILTER	20 MESH	
COOLANT PUMP	SST CENTRIFUGAL		COOLANT CIRCUIT	NON-FERROUS	
EVAPORATOR	BRAZED PLATE		CAPACITY CONTROL	HOT GAS BYPASS	
CONDENSER	SHELL & TUBE		REFRIGERANT	32 LBS R-410A	
			FRAME	GALVANIZED STEEL	
			PANELS	POWDER COATED STEEL	
RESERVOIR	140 GALLON POLYETHYLENE		WEIGHT (OPERATING)	5160	LBS
POWER	460V/3PH/60HZ		WEIGHT (SHIPPING)	3800	LBS
CONTROL CIRCUIT	24/120	VAC	ELECTRICAL ENCLOSURE	NEMA 12	
COMPRESSOR RATED LOAD AMPS	(2) @ 54.5 AMPS EACH		CONTROL	MICROPROCESSOR	

7-3 Pump Curves, Flow, and Pressure Considerations

60 Hertz Pump Curves

ACS CHILLER PUMPS

20-50 ALL 60 Hz

September 8, 2009

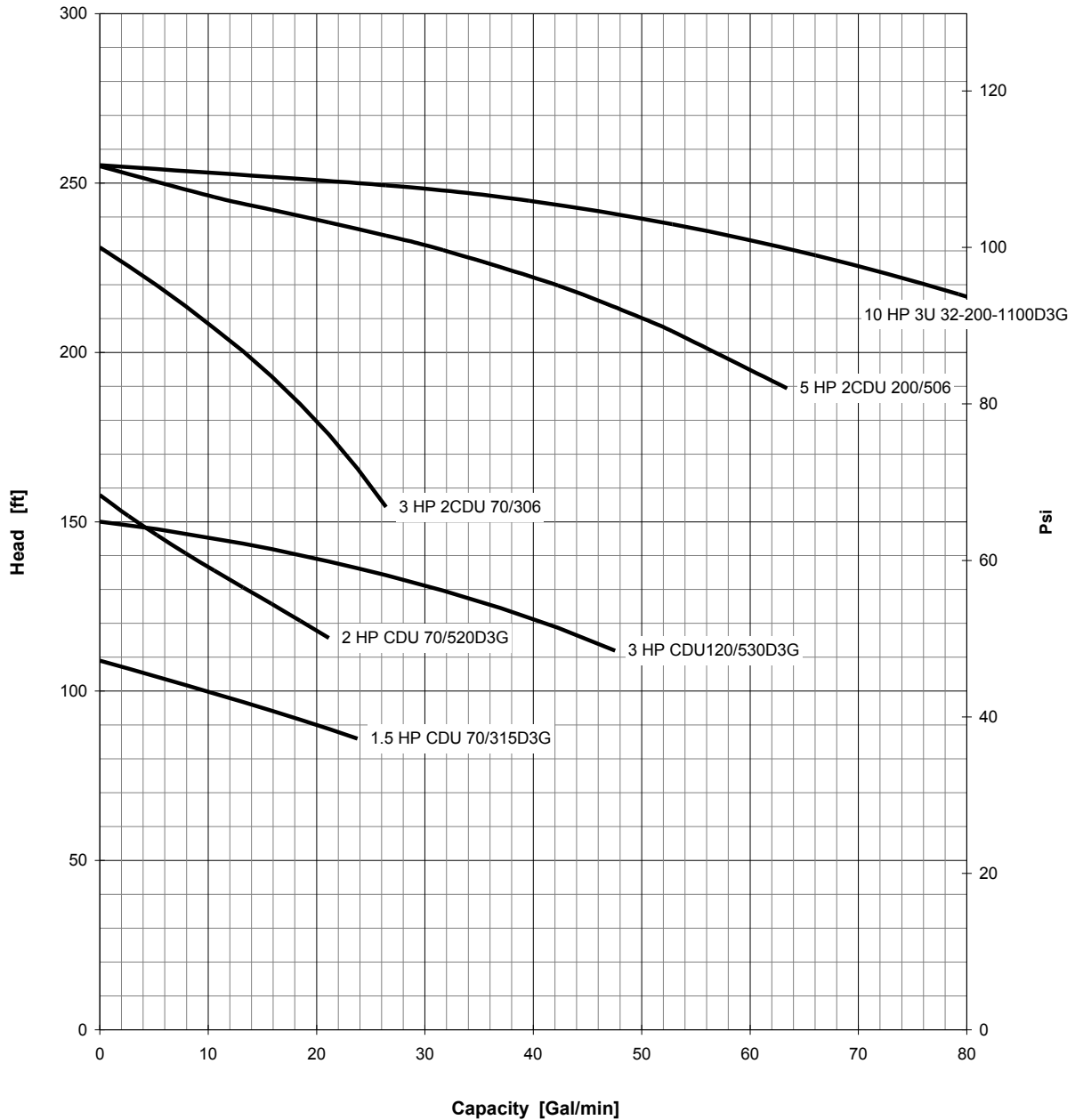

HP	Model	GP 20	GP 30	GP 40	GP 50
1.5	CDU 70/315D3G	STD			
2	CDU 70/520D3G	OPT	STD	STD	
3	CDU 120/530D3G		OPT	OPT	STD
3	2CDU 70/306	OPT			
5	2CDU 200/506	OPT	OPT	OPT	OPT
10	3U 32-200-1100D3G			OPT	OPT

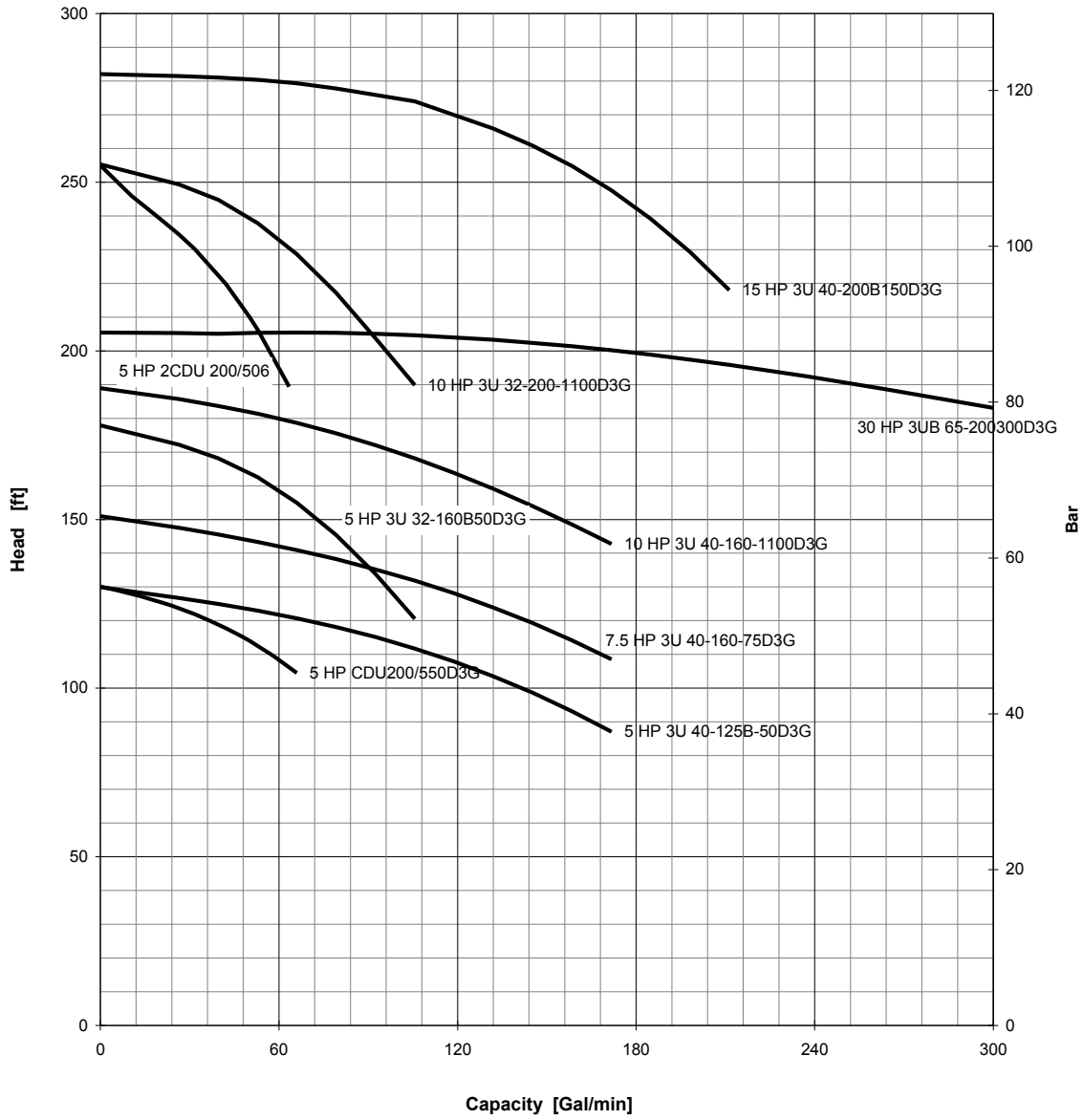

HP	Model	GP70	GP90	GP105	GP 140	GP175	GP210
5	CDU 200/550D3G	STD	STD	STD			
5	3U 32-160B50D3G	OPT	OPT	OPT	STD	STD	
5	3U 40-125B50D3G						STD
5	2CDU 200/506D3G	OPT					
7.5	3U 40-160-75D3G					OPT	
10	3U 32-200-1100D3G		OPT	OPT			OPT
15	3U 40-200B150D3G	OPT	OPT	OPT	OPT	OPT	OPT
30	3UB 65-200300D3G					OPT	OPT

50 Hertz Pump Curves

ACS CHILLER PUMPS

20-50 ALL 50 Hz

September 8, 2009

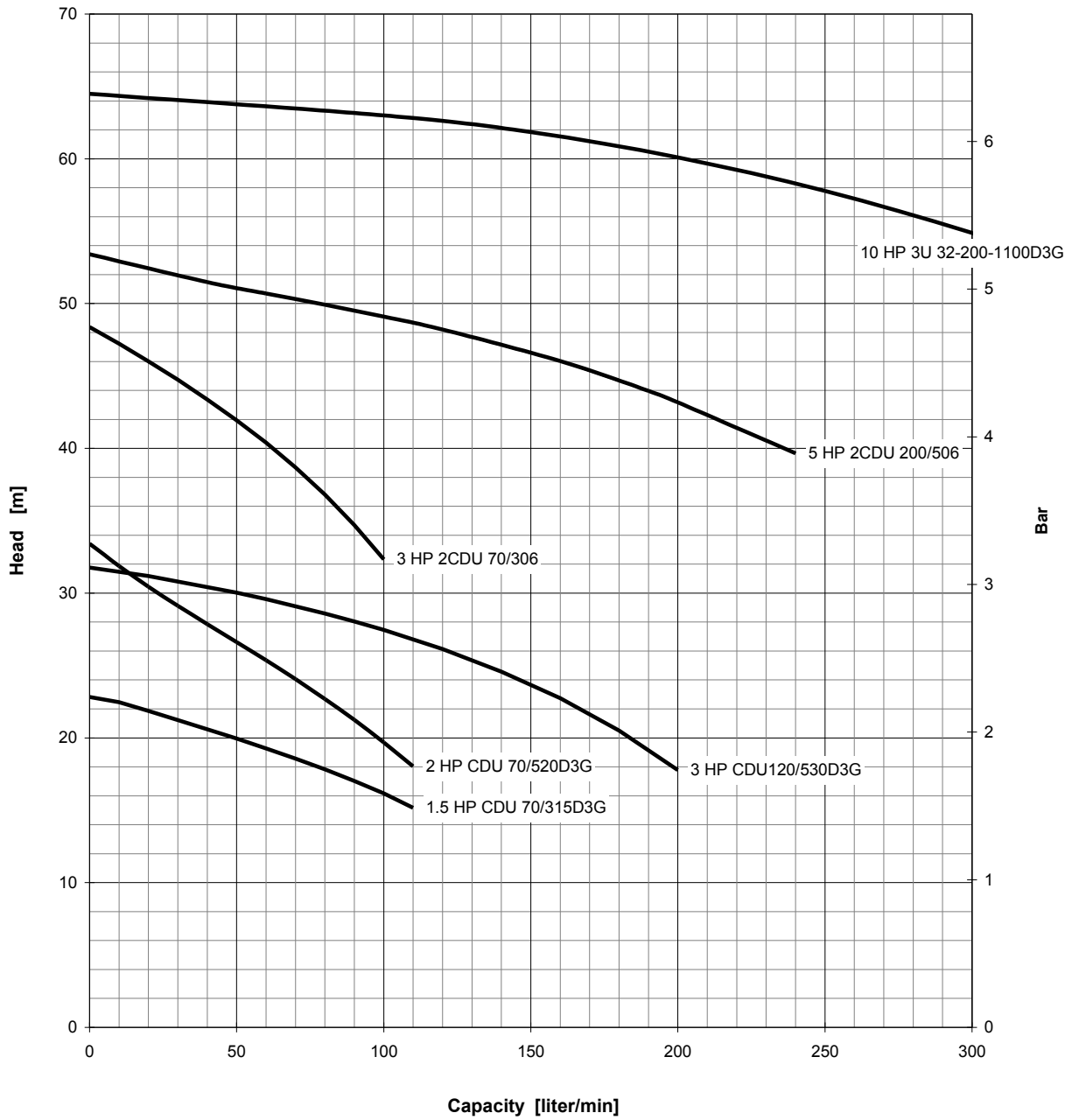

HP	Model	GP 20	GP 30	GP 40	GP 50
1.5	CDU 70/315D3G	STD			
2	CDU 70/520D3G	OPT	STD	STD	
3	CDU 120/530D3G		OPT	OPT	STD
3	2CDU 70/306	OPT			
5	2CDU 200/506	OPT	OPT	OPT	OPT
10	3U 32-200-1100D3G			OPT	OPT

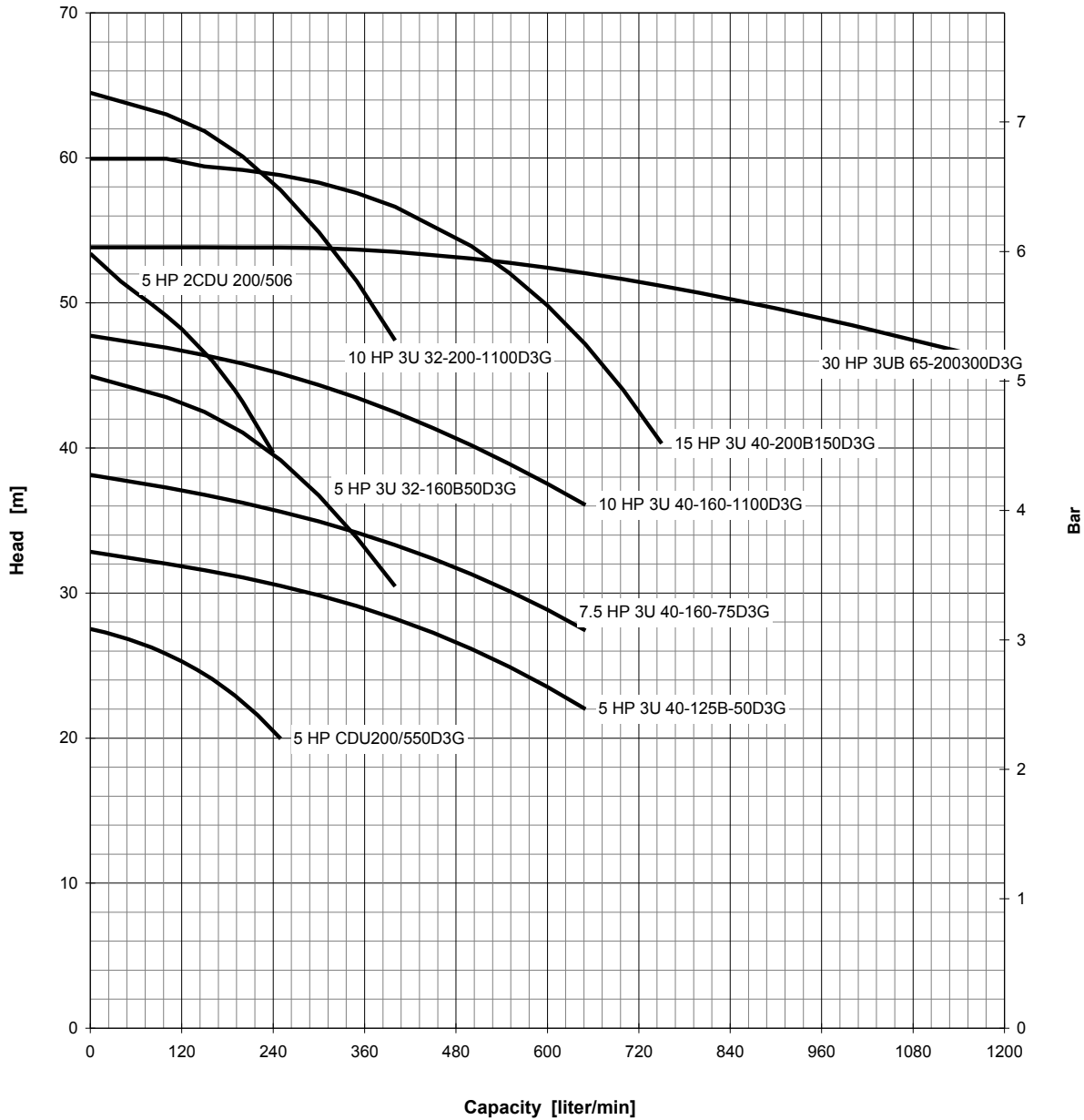

HP	Model	GP70	GP90	GP105	GP 140	GP175	GP210
5	CDU 200/550D3G	STD	STD	STD			
5	3U 32-160B50D3G	OPT	OPT	OPT	STD	STD	
5	3U 40-125B50D3G						STD
5	2CDU 200/506D3G	OPT					
7.5	3U 40-160-75D3G					OPT	
10	3U 32-200-1100D3G		OPT	OPT			OPT
15	3U 40-200B150D3G	OPT	OPT	OPT	OPT	OPT	OPT
30	3UB 65-200300D3G					OPT	OPT

Pure Water at >40°F								
	GPXC-20		GPXC-30		GPXC-40		GPXC-50	
	GPM	DP (PSI)	GPM	DP (PSI)	GPM	DP (PSI)	GPM	DP (PSI)
0.5X Nominal	6	1.7	9	1.7	12	1.6	18	1.8
1.0X Nominal	12	5.9	18	6.1	24	5.8	36	6.4
2.0X Nominal	24	21.4	36	21.9	48	20.7	72	23.3

	GPXC-70		GPXC-90		GPXC-140		GPXC-175	
0.5X Nominal	24	1.7	30	1.8	36	1.7	48	1.8
1.0X Nominal	48	6.1	60	6.5	72	6.1	96	6.4
2.0X Nominal	96	21.9	120	23.5	144	22.1	192	23.6

	GPXC-210	
0.5X Nominal	72	1.7
1.0X Nominal	144	6.2
2.0X Nominal	288	22.7

Calculating Chiller Nominal Flow and Pressure to Process

- **Flow rate:** Obtain the flow reading from the appropriate pump curve.
- **Pressure:** Obtain a corresponding pressure reading from the pump curve you selected, then **subtract** the one-pump pressure drop listed in the above table using the appropriate chiller hp and flow rate.

7-4 Remote Air-Cooled Chiller Configurations

Configuration A:

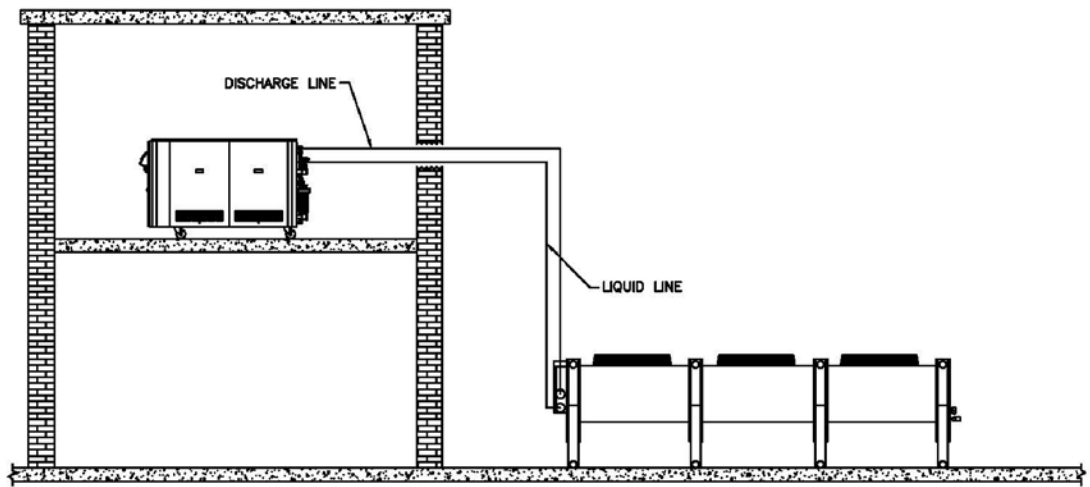

* Liquid line riser should not exceed 15 feet from base of air-cooled condenser.

Configuration B:

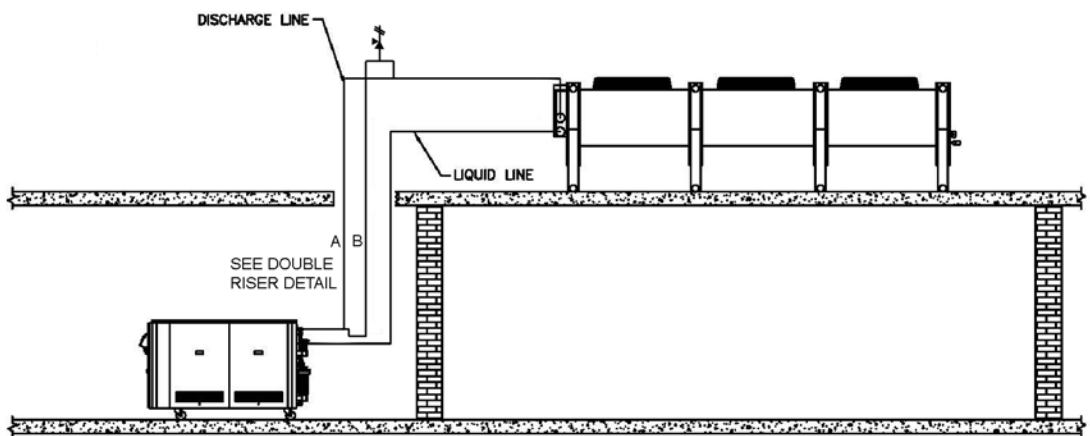

Configuration C:

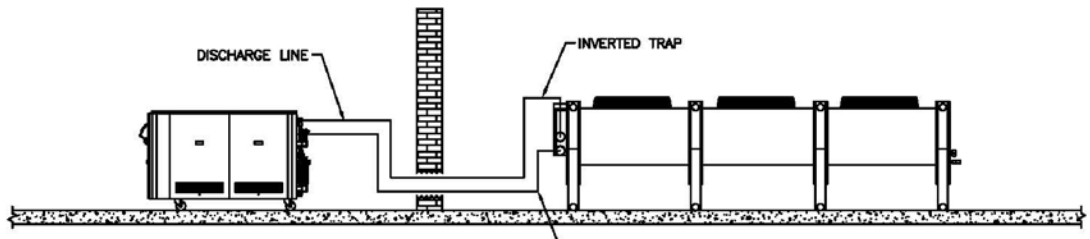

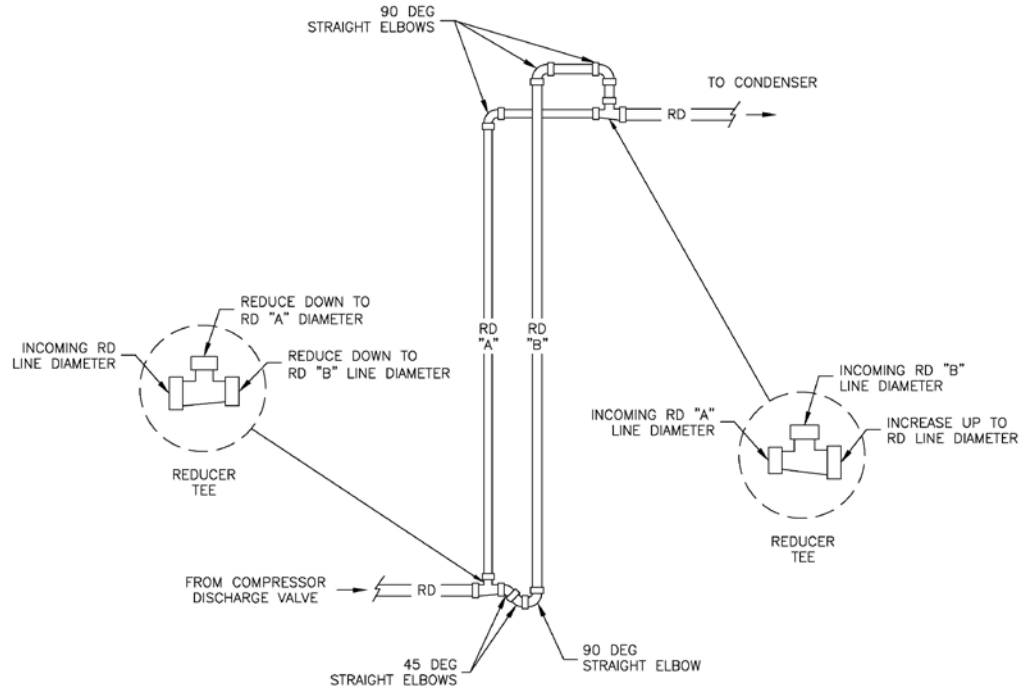
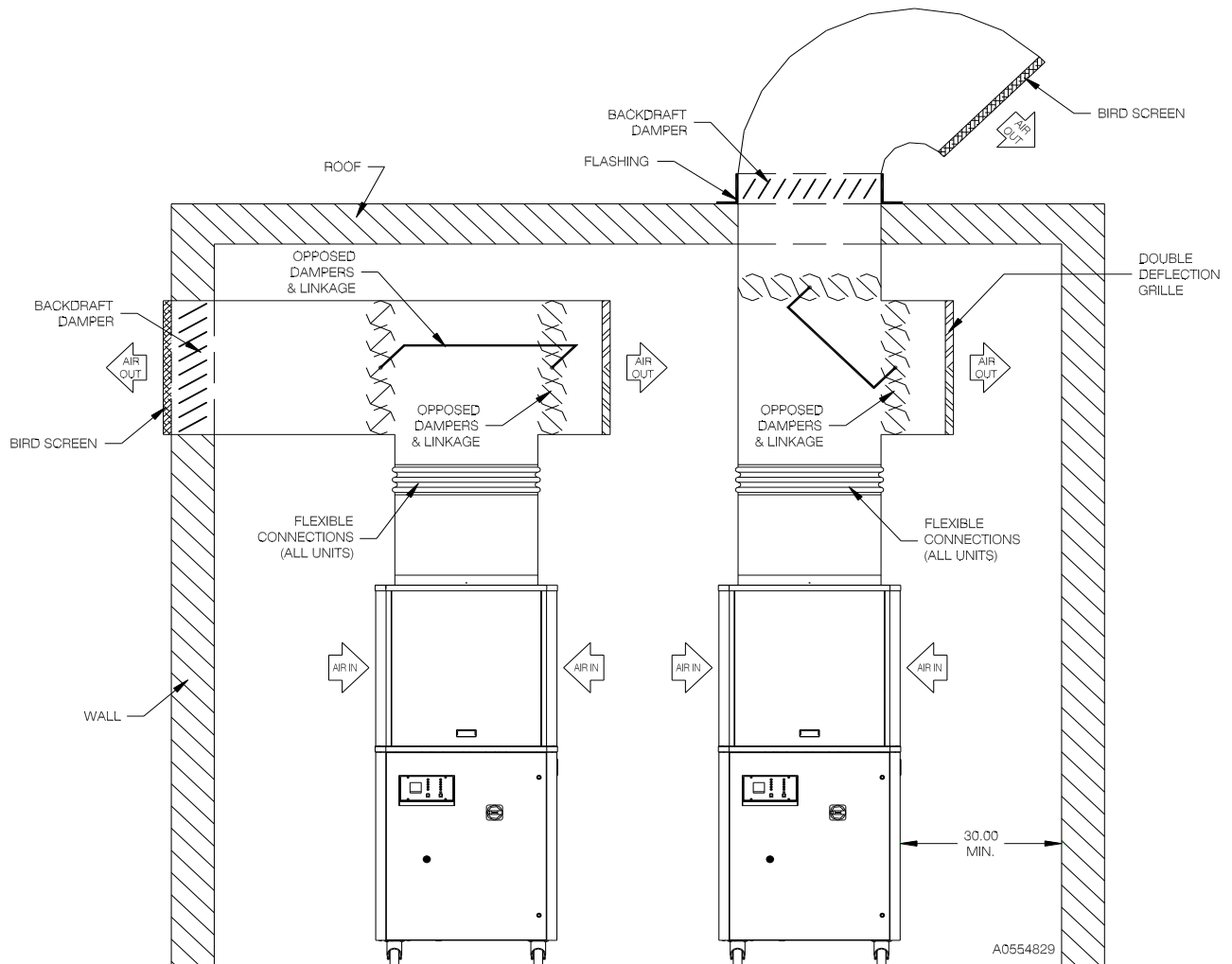

Figure 19: Double Riser Detail

7-5 Typical Ductwork for Air-Cooled Chillers



Model	Fan		60 Hz Discharge air volume		50 Hz Discharge air volume	
	HP	kW	CFM	m ³ /min	CFM	m ³ /min
GPAC-20	0.5	0.4	4230	120	3525	100
GPAC-30	1.0	0.7	6343	180	5286	150
GPAC-40	1.0	0.7	8458	240	7048	200
GPAC-50	2.0	1.5	12687	360	10573	300
GPAC-70	(2) 1.0	(2) 0.7	16916	479	14097	399
GPAC-90	(2) 2.0	(2) 1.4	25374	718	21145	598
GPAC-105	(2) 2.0	(2) 1.4	25374	718	21145	598
GPAC-140	(3) 2.0	(3) 1.4	38061	1077	31718	898
GPAC-175	(3) 2.0	(3) 1.4	38061	1077	31718	898
GPAC-210	(4) 2.0	(4) 1.4	50748	1436	42290	1197

When locating your air-cooled portable chiller and designing its ductwork, note any potential high temperature conditions when discharging into your building and any negative pressures with the building when discharging air outside.

Notes:

- Customer use of ductwork requires the high pressure fan option.
- Allow 30 in. (77 cm) minimum clearance around the chiller footprint to facilitate free passage of cooling air and service accessibility.
- Figure 20 shows the pressure loss per foot of ductwork. Calculate the total equivalent length before using the data below.
- Support ductwork from the building structure, not off of the chiller.
- Back draft damper to outside must be closed at all times when fan/blower is not operating. Size the damper so that the pressure drop across is no greater than 0.2 in WG (50 Pascal) at the rated output.
- Chillers are designed to operate at a condensing entering air temperature of 60°F (16°C) minimum without optional Variable Frequency Drive.

Figure 20 - Loss of Pressure through round duct - inches of water column per equivalent foot

Nominal Duct Diameter (in / cm)	60 hz Condenser Fan Flow Rate (cfm / cmm)				50 hz Condenser Fan Flow Rate (cfm / cmm)			
	GPAC-20	GPAC-30	GPAC-40	GPAC-50	GPAC-20	GPAC-30	GPAC-40	GPAC-50
	4230 / 120	6343 / 180	8458 / 240	12687 / 360	3525 / 100	5286 / 150	7048 / 200	10573 / 300
18 / 45	0.003	0.007	0.013	0.03	0.002	0.005	0.009	0.020
20 / 50	0.002	0.005	0.008	0.02	0.001	0.003	0.005	0.012
22 / 55	0.001	0.003	0.005	0.01		0.002	0.003	0.007
24 / 60		0.002	0.003	0.007		0.001	0.002	0.005
26 / 65		0.001	0.002	0.004			0.001	0.003
28 / 70			0.001	0.003				0.002
30 / 75				0.002				0.002
32 / 80				0.002				0.001
36 / 90				0.001				

Note: 1 inch of water column = 250 Pascal

7-6 Piping Diagrams

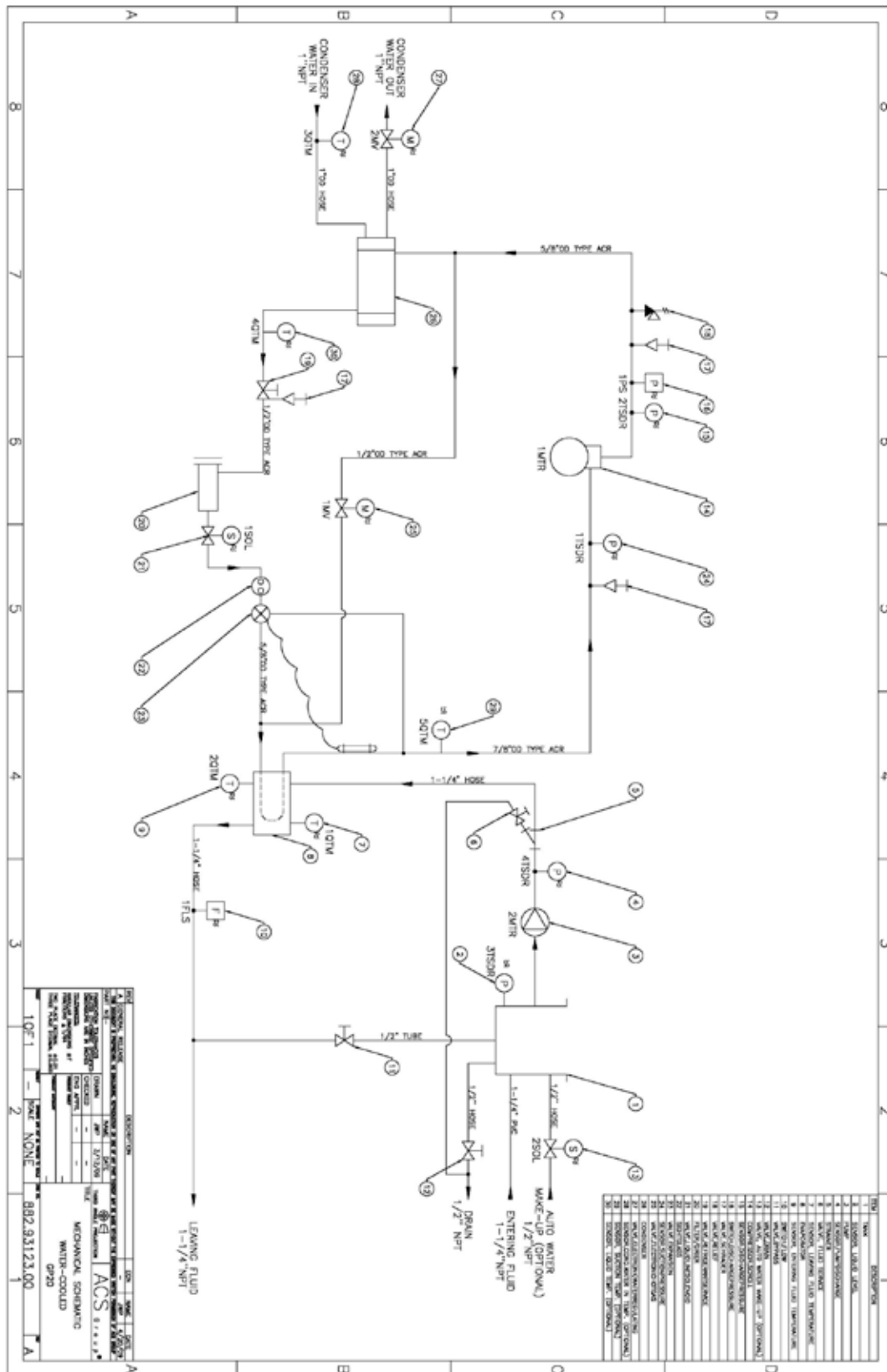

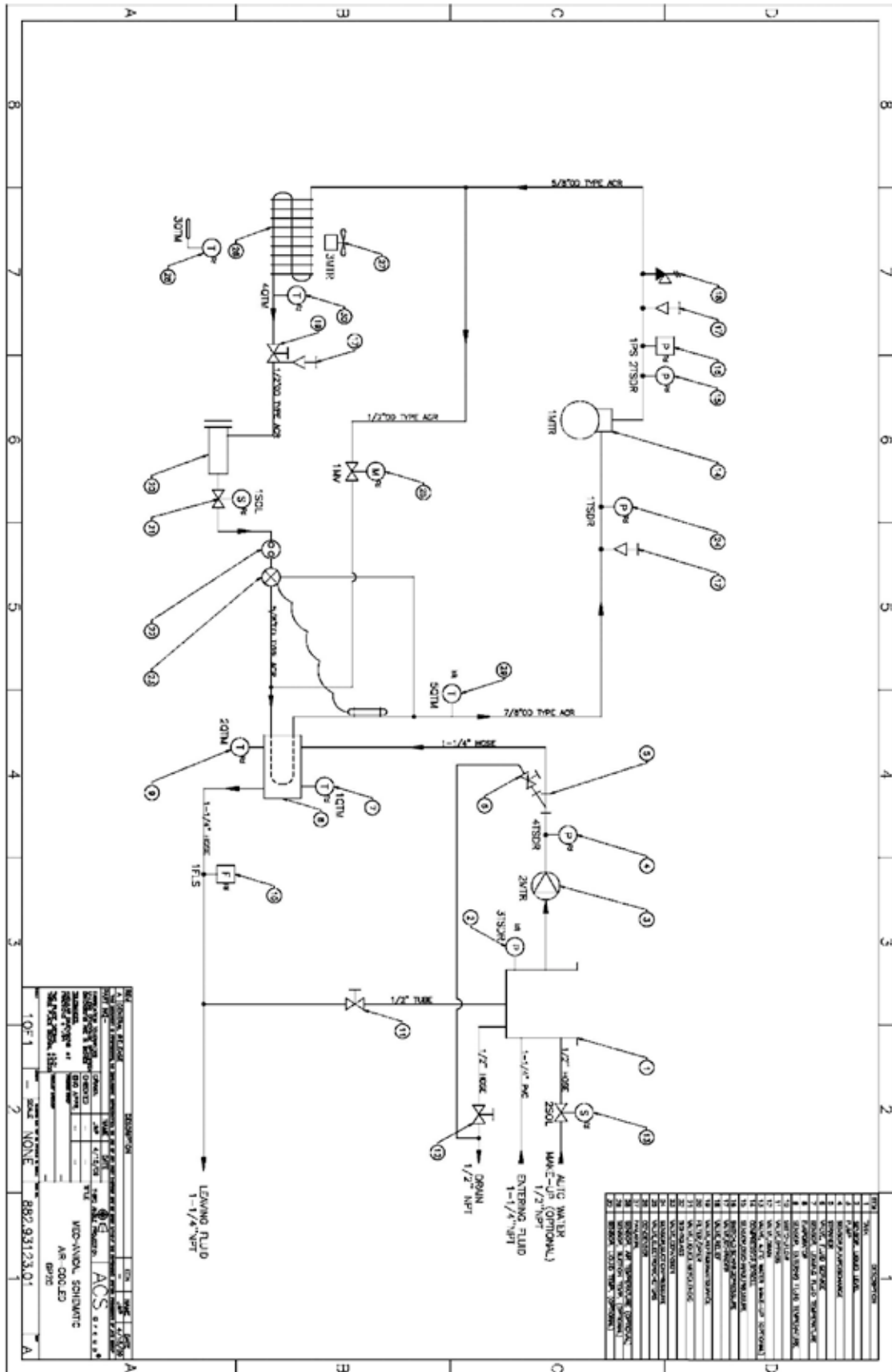

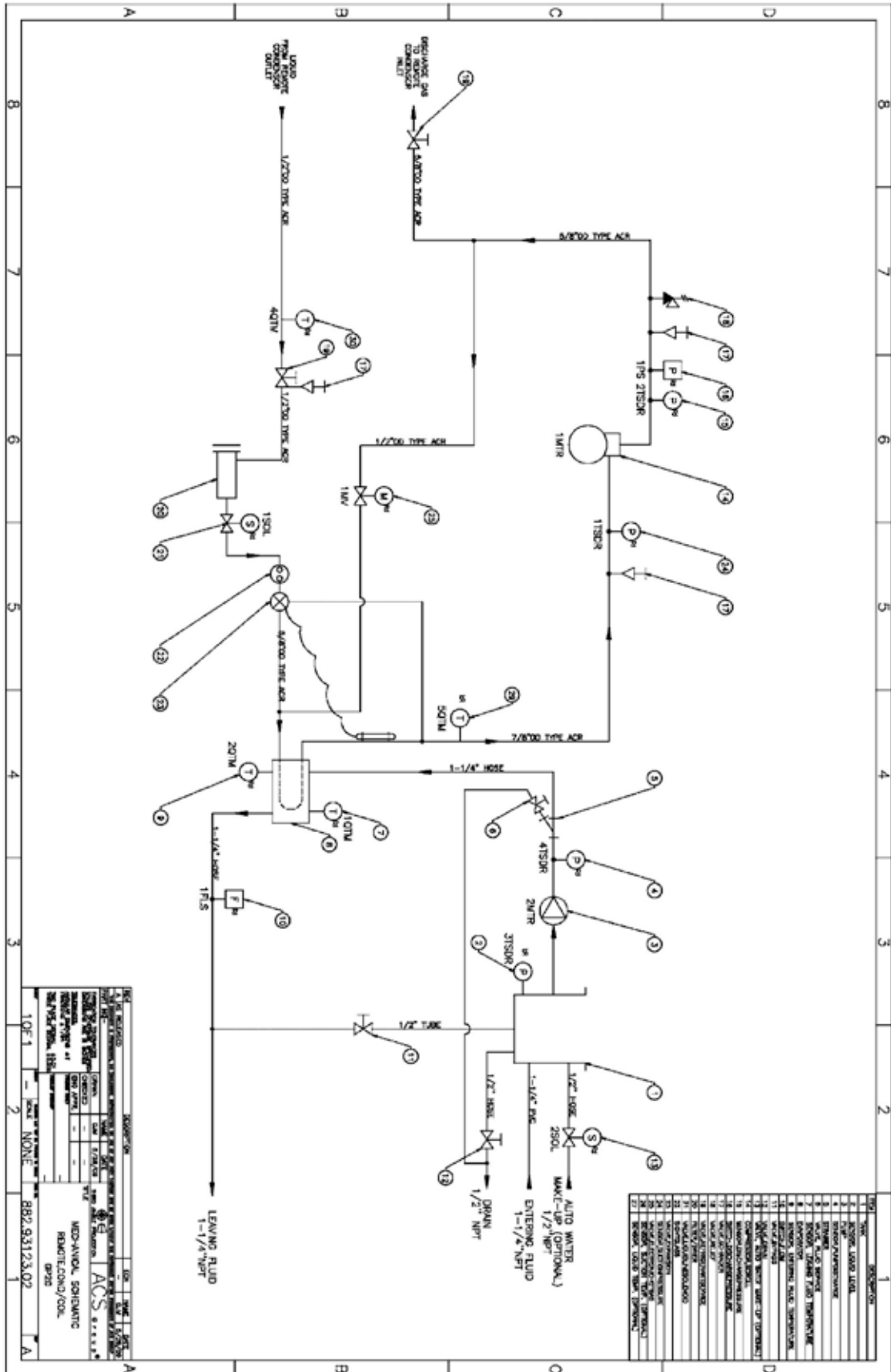

NO.	DESCRIPTION	QTY	UNIT
1	COMPRESSOR	1	EA
2	CONDENSER	1	EA
3	EVAPORATOR	1	EA
4	EXPANSION VALVE	1	EA
5	PUMP	1	EA
6	PUMP	1	EA
7	PUMP	1	EA
8	PUMP	1	EA
9	PUMP	1	EA
10	PUMP	1	EA
11	PUMP	1	EA
12	PUMP	1	EA
13	PUMP	1	EA
14	VALVE	1	EA
15	VALVE	1	EA
16	VALVE	1	EA
17	VALVE	1	EA
18	VALVE	1	EA
19	VALVE	1	EA
20	VALVE	1	EA
21	VALVE	1	EA
22	VALVE	1	EA
23	VALVE	1	EA
24	VALVE	1	EA
25	VALVE	1	EA
26	SENSOR	1	EA
27	SENSOR	1	EA
28	SENSOR	1	EA
29	SENSOR	1	EA
30	SENSOR	1	EA
31	SENSOR	1	EA
32	SENSOR	1	EA
33	SENSOR	1	EA
34	SENSOR	1	EA
35	SENSOR	1	EA
36	SENSOR	1	EA
37	SENSOR	1	EA
38	SENSOR	1	EA
39	SENSOR	1	EA
40	SENSOR	1	EA
41	LIQUID RECEIVER	1	EA
42	DRAIN	1	EA

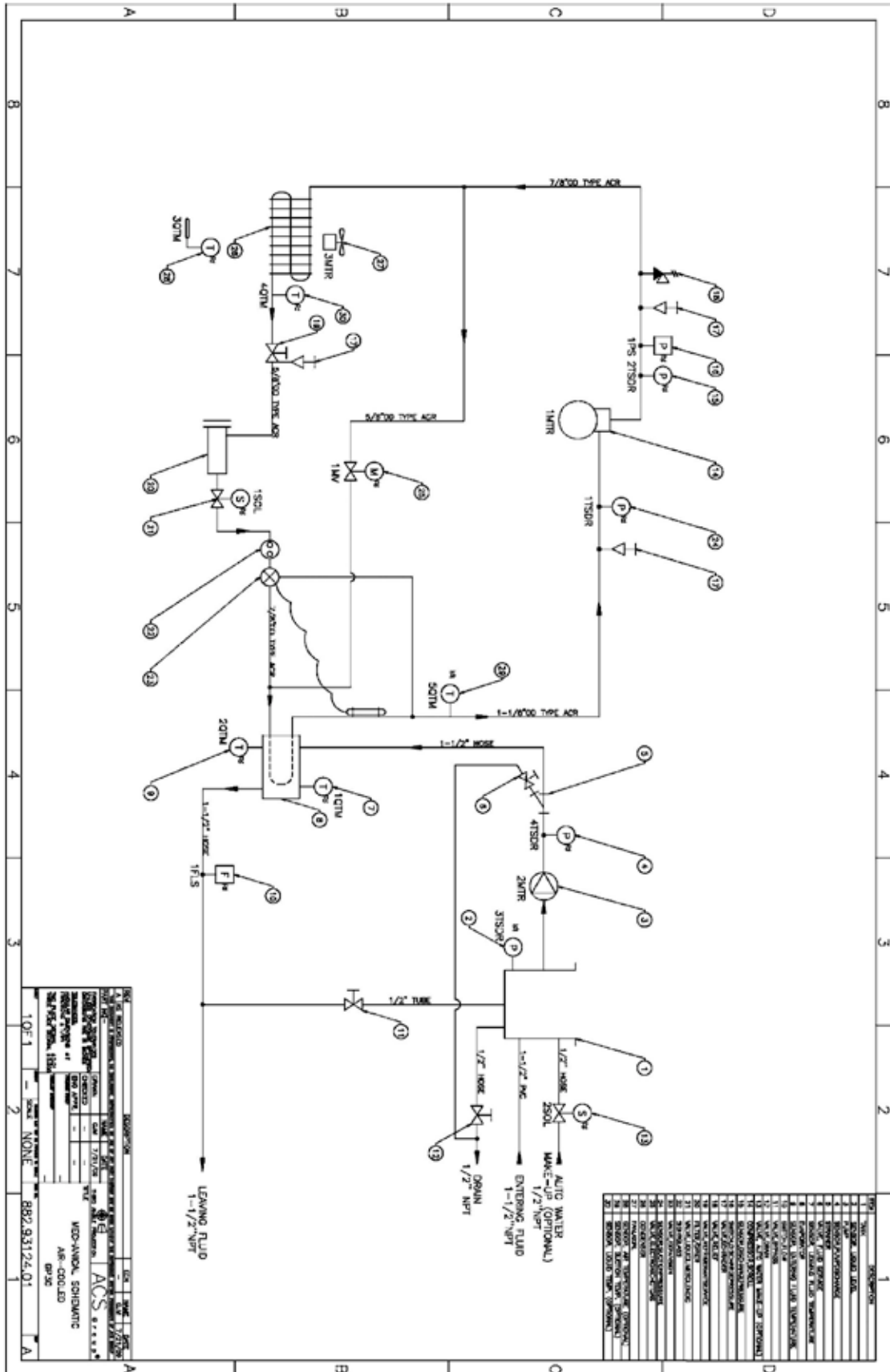

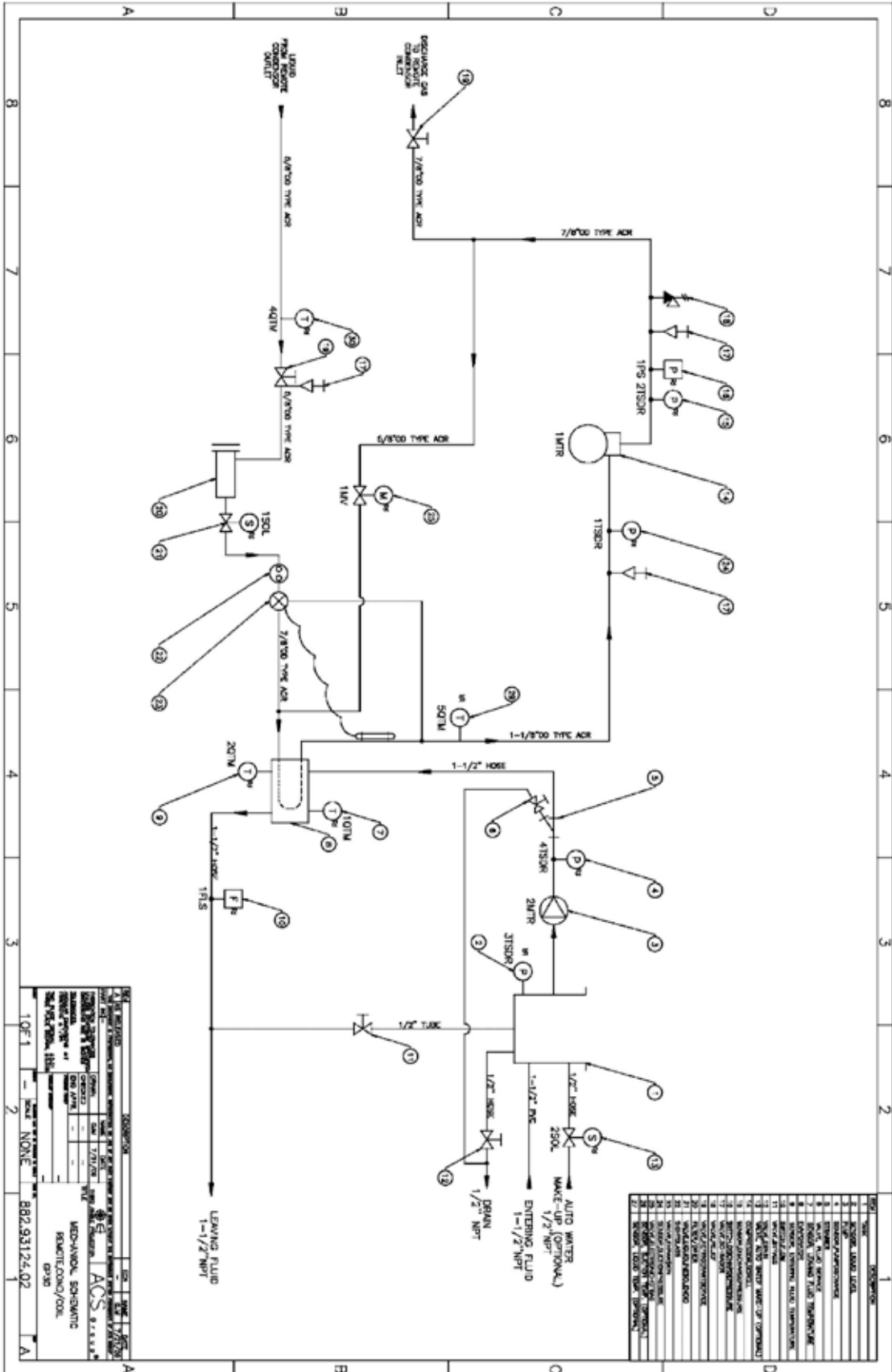

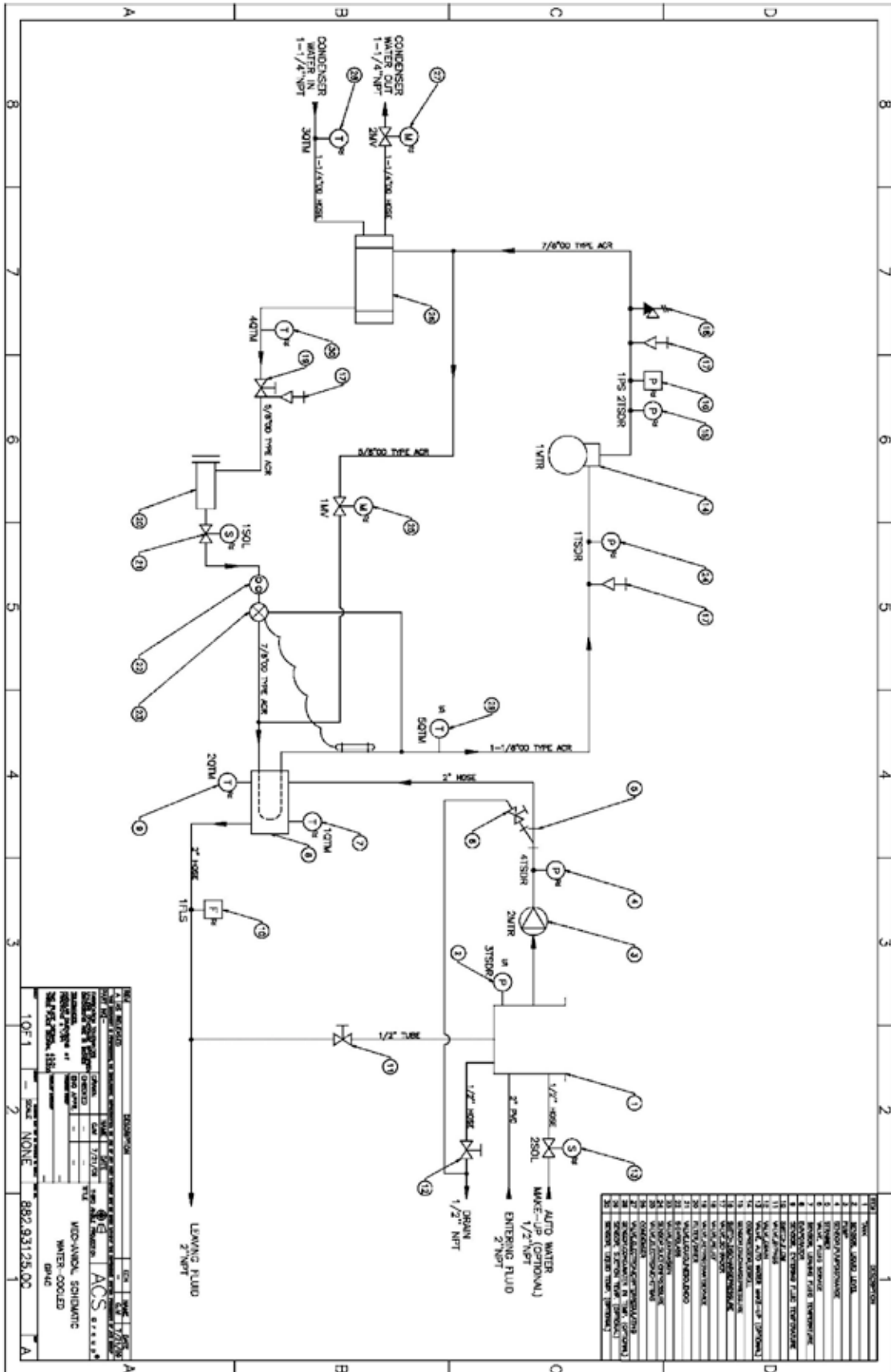

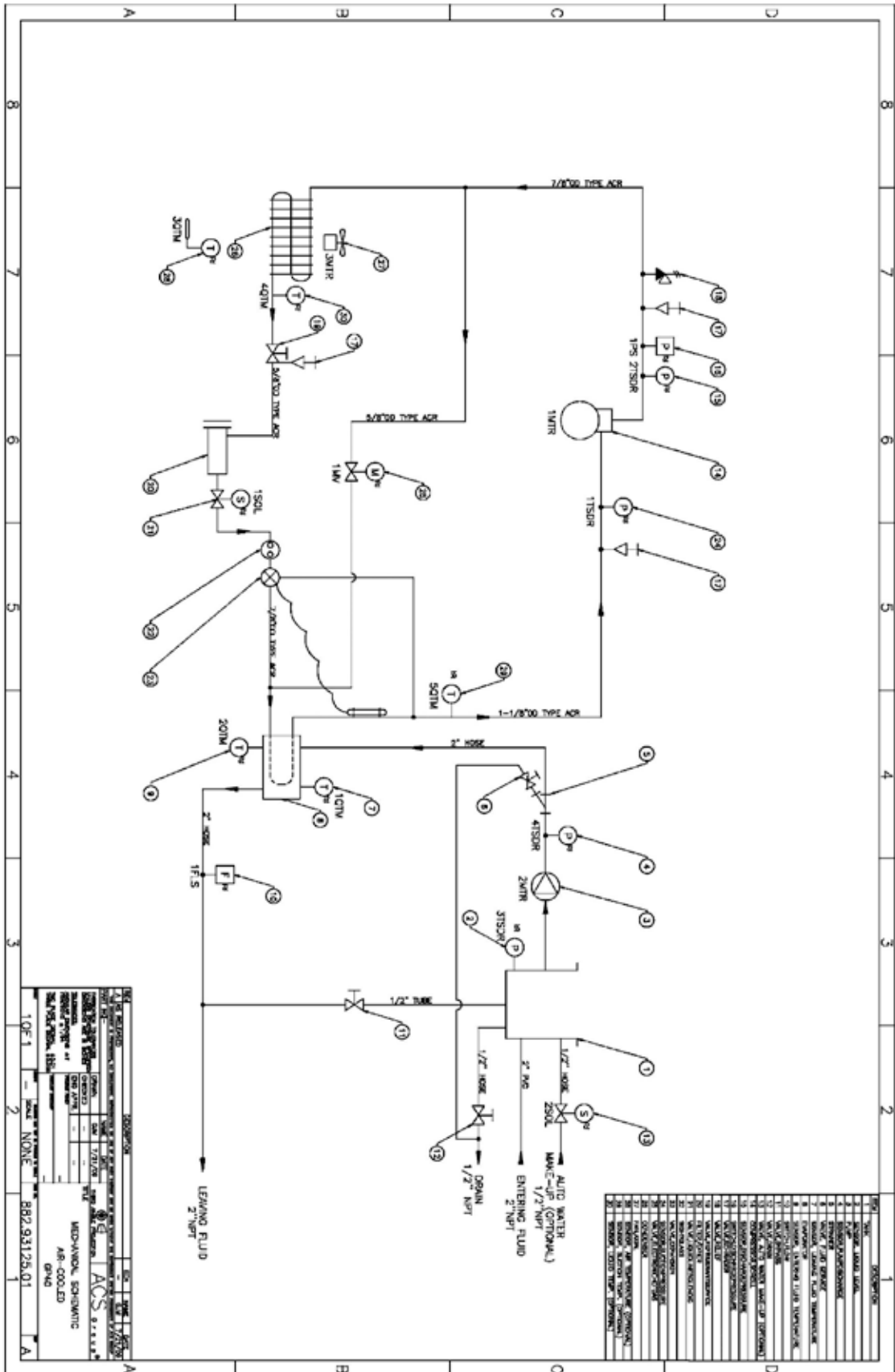

REVISIONS		DATE	BY	CHKD BY
1	ASSEMBLY	7/17/06	AS	AS
2	REVISIONS	7/17/06	AS	AS

TITLE		DATE
10E-1	NON-FLUOR	882.93125.01

MED-VANTOL SCIENTIFIC
 AIR-COOLED
 882.93125.01

REVISIONS	
1	ASSEMBLY
2	REVISIONS
3	
4	
5	
6	
7	
8	
9	
10	
11	
12	
13	
14	
15	
16	
17	
18	
19	
20	
21	
22	
23	
24	
25	
26	
27	
28	
29	
30	
31	
32	
33	
34	
35	
36	
37	
38	
39	
40	
41	
42	
43	
44	
45	
46	
47	
48	
49	
50	

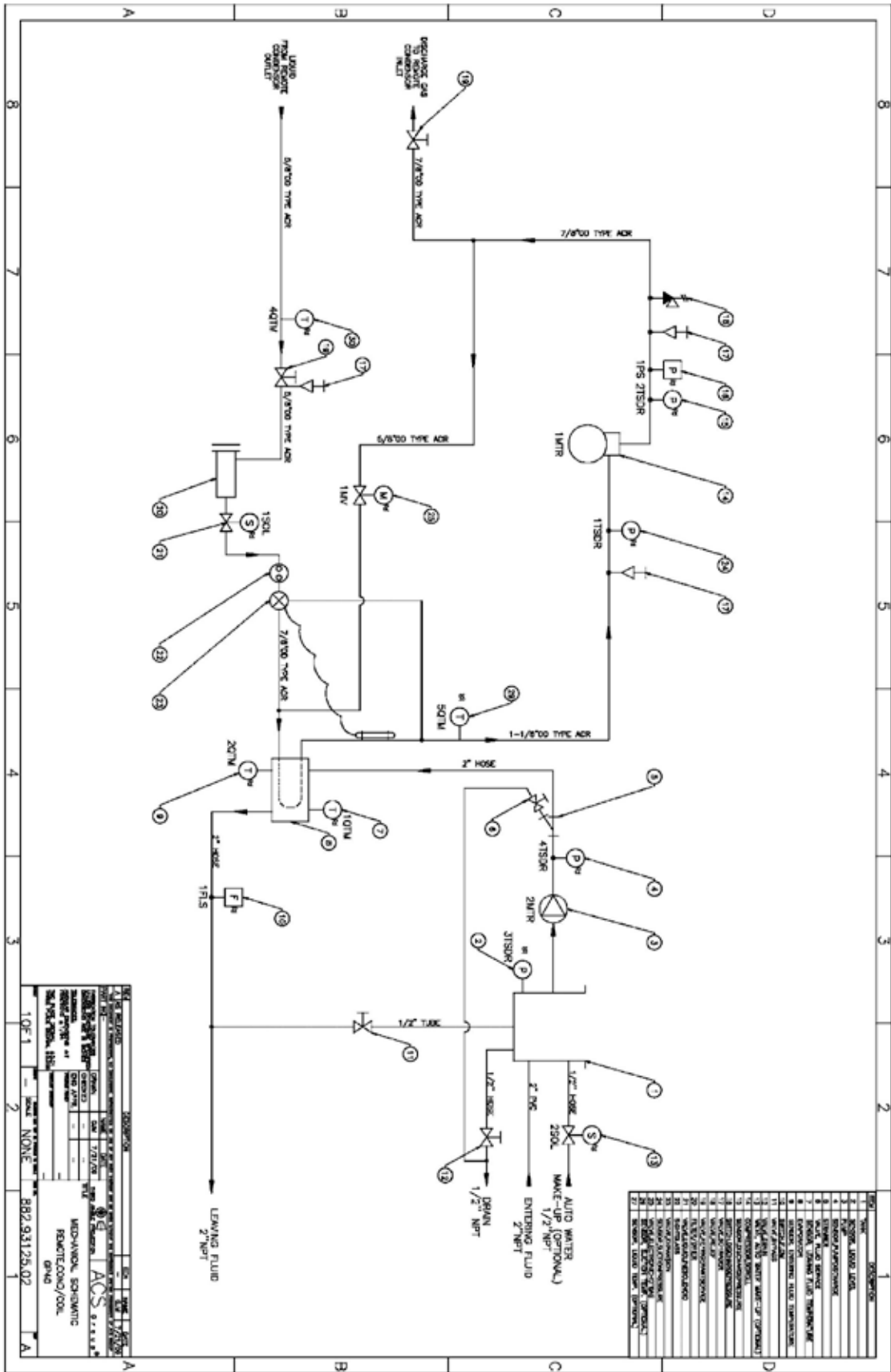

REVISIONS	
NO.	DESCRIPTION
1	ISSUED FOR CONSTRUCTION
2	REVISIONS TO BE MADE BY THE CONTRACTOR
3	REVISIONS TO BE MADE BY THE CONTRACTOR
4	REVISIONS TO BE MADE BY THE CONTRACTOR
5	REVISIONS TO BE MADE BY THE CONTRACTOR
6	REVISIONS TO BE MADE BY THE CONTRACTOR
7	REVISIONS TO BE MADE BY THE CONTRACTOR
8	REVISIONS TO BE MADE BY THE CONTRACTOR
9	REVISIONS TO BE MADE BY THE CONTRACTOR
10	REVISIONS TO BE MADE BY THE CONTRACTOR
11	REVISIONS TO BE MADE BY THE CONTRACTOR
12	REVISIONS TO BE MADE BY THE CONTRACTOR
13	REVISIONS TO BE MADE BY THE CONTRACTOR
14	REVISIONS TO BE MADE BY THE CONTRACTOR
15	REVISIONS TO BE MADE BY THE CONTRACTOR
16	REVISIONS TO BE MADE BY THE CONTRACTOR
17	REVISIONS TO BE MADE BY THE CONTRACTOR
18	REVISIONS TO BE MADE BY THE CONTRACTOR
19	REVISIONS TO BE MADE BY THE CONTRACTOR
20	REVISIONS TO BE MADE BY THE CONTRACTOR
21	REVISIONS TO BE MADE BY THE CONTRACTOR
22	REVISIONS TO BE MADE BY THE CONTRACTOR
23	REVISIONS TO BE MADE BY THE CONTRACTOR
24	REVISIONS TO BE MADE BY THE CONTRACTOR
25	REVISIONS TO BE MADE BY THE CONTRACTOR
26	REVISIONS TO BE MADE BY THE CONTRACTOR
27	REVISIONS TO BE MADE BY THE CONTRACTOR
28	REVISIONS TO BE MADE BY THE CONTRACTOR
29	REVISIONS TO BE MADE BY THE CONTRACTOR
30	REVISIONS TO BE MADE BY THE CONTRACTOR

10E-1
 NONE
 MED-VANCO, SCHEMATIC
 REVISIONS/DOE
 882.93125.02
 8/90

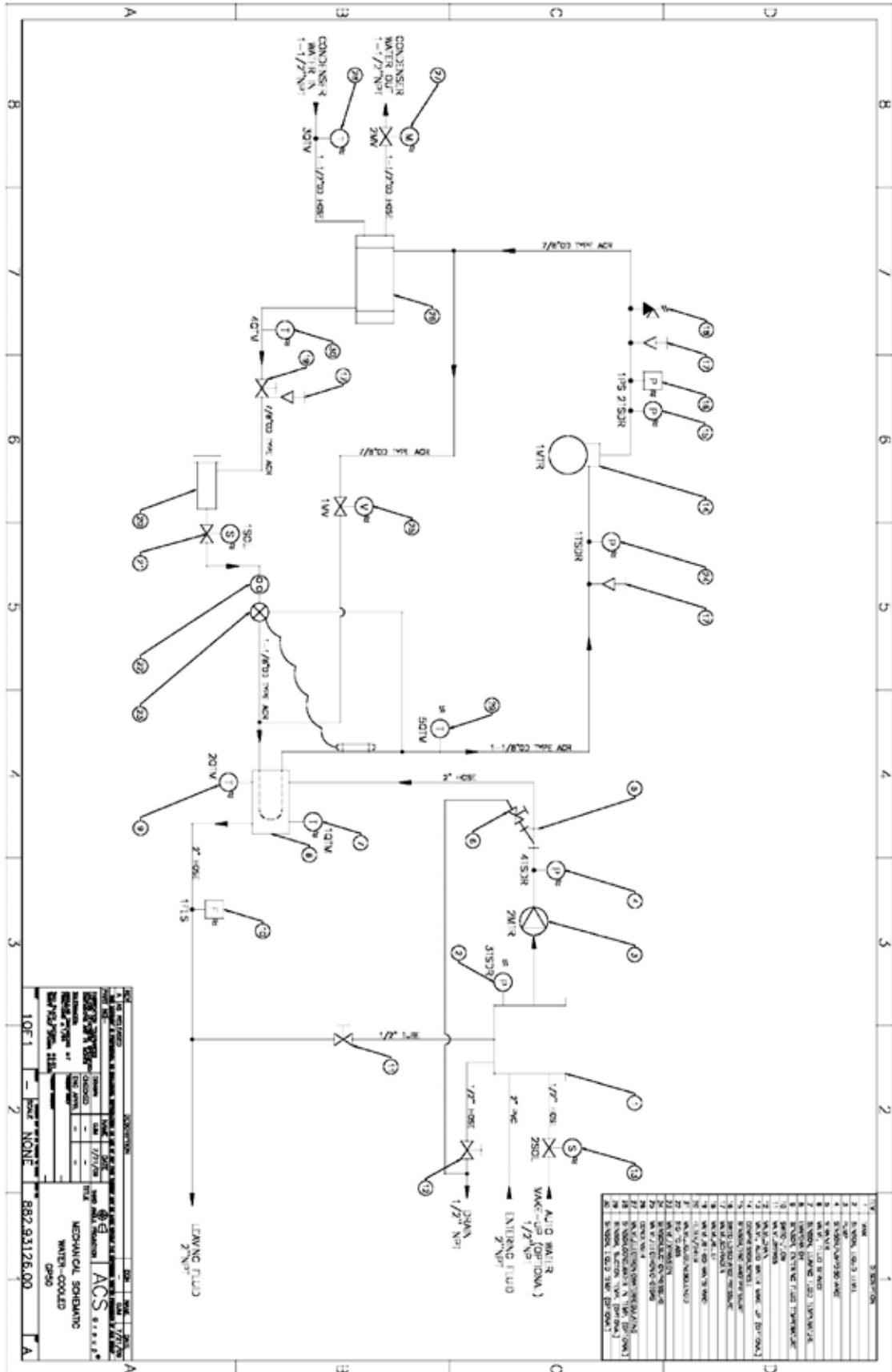

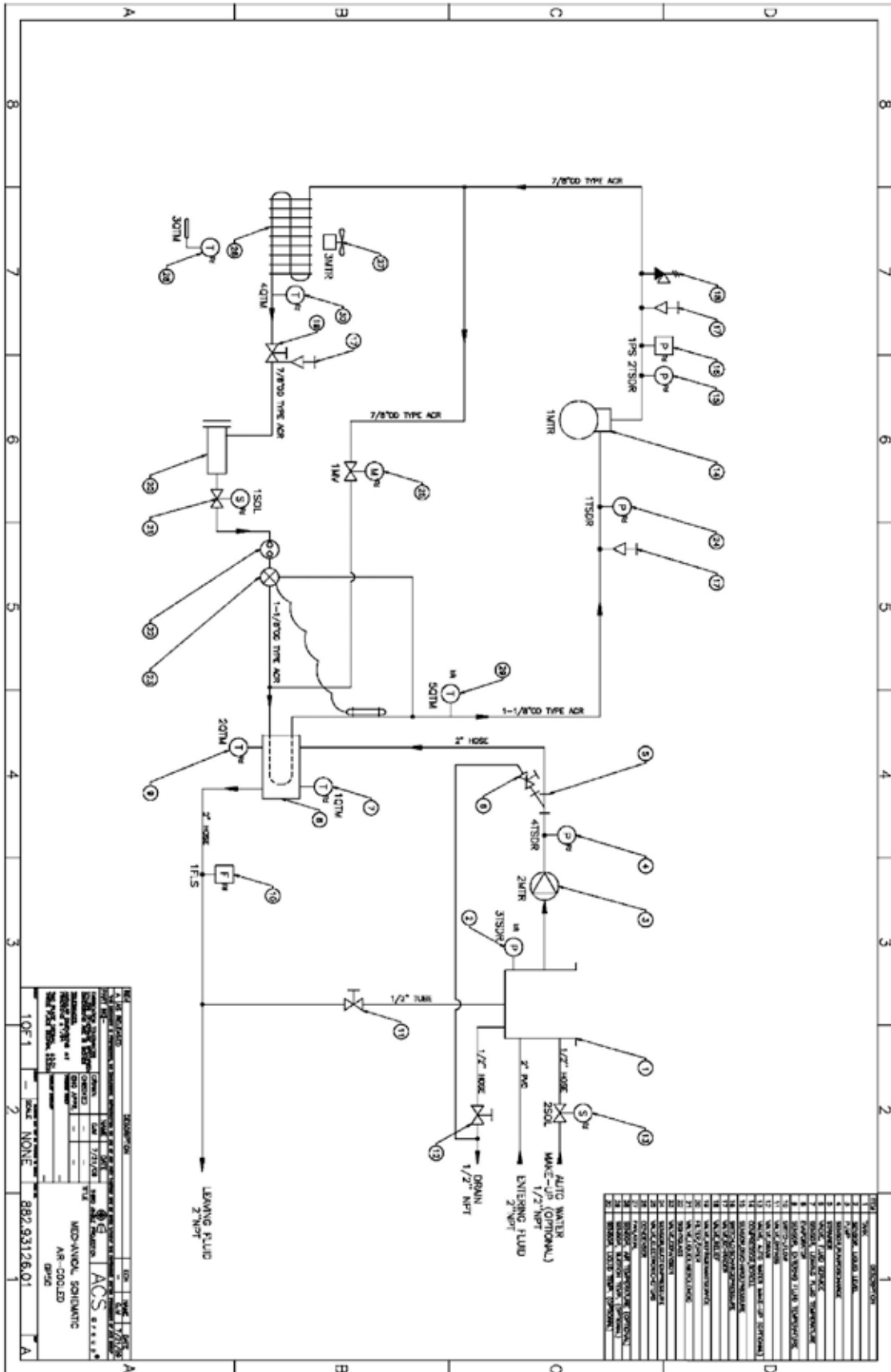

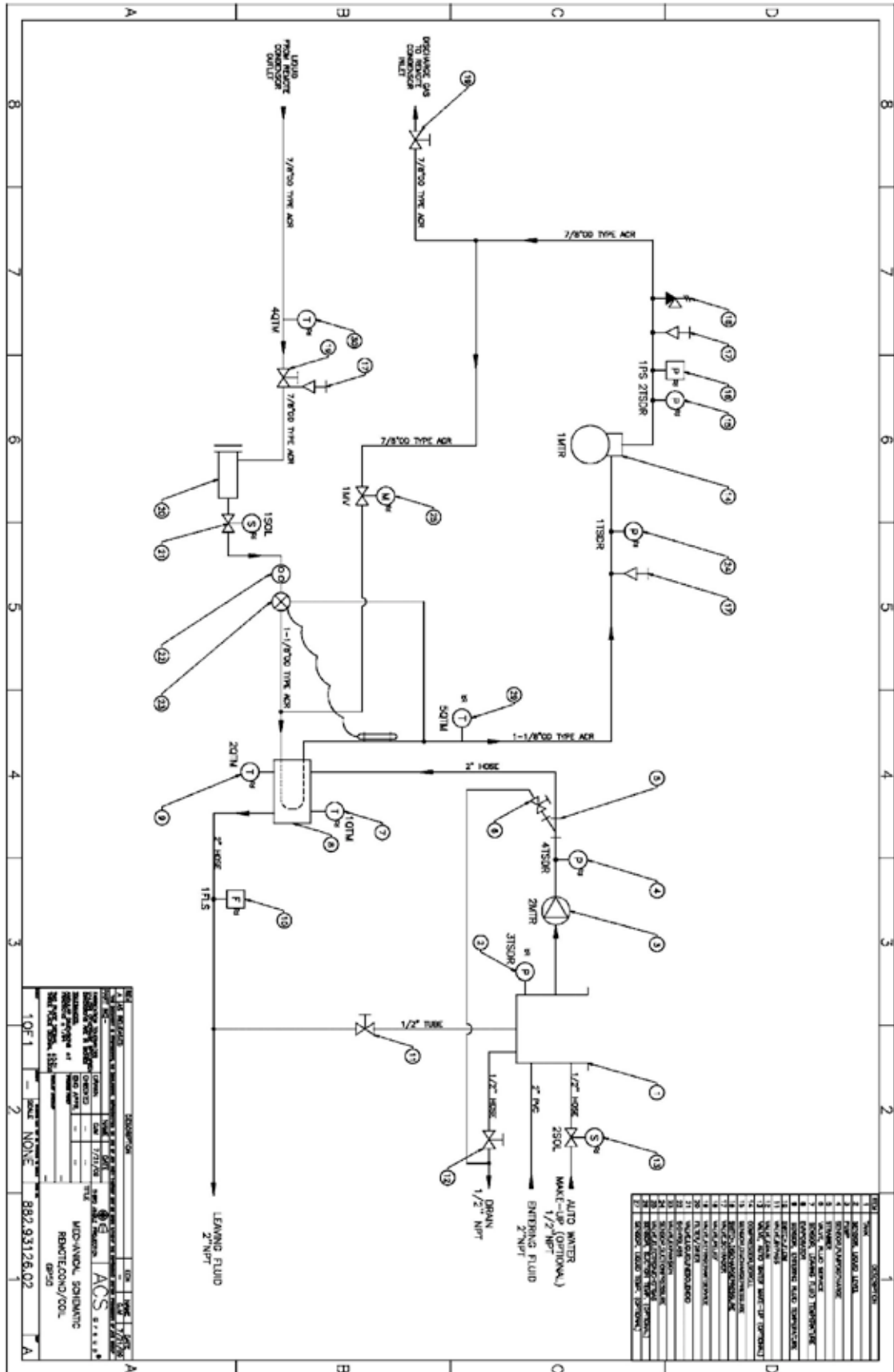

Free Manuals Download Website

<http://myh66.com>

<http://usermanuals.us>

<http://www.somanuals.com>

<http://www.4manuals.cc>

<http://www.manual-lib.com>

<http://www.404manual.com>

<http://www.luxmanual.com>

<http://aubethermostatmanual.com>

Golf course search by state

<http://golfingnear.com>

Email search by domain

<http://emailbydomain.com>

Auto manuals search

<http://auto.somanuals.com>

TV manuals search

<http://tv.somanuals.com>