

# STIGA VILLA

---

92 M

---

107 M

---

**8211-3037-03**





1.

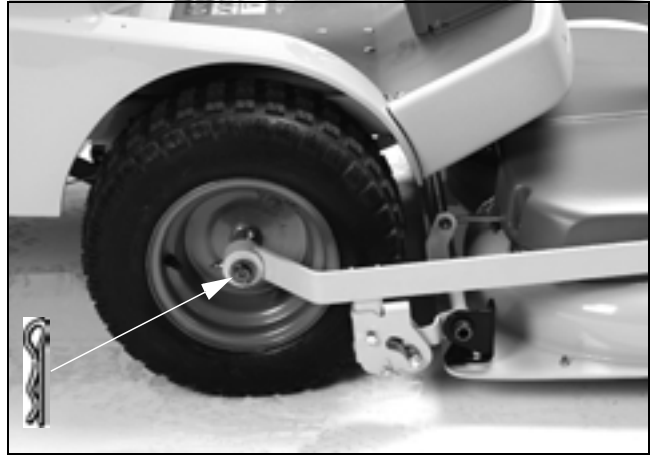

2.

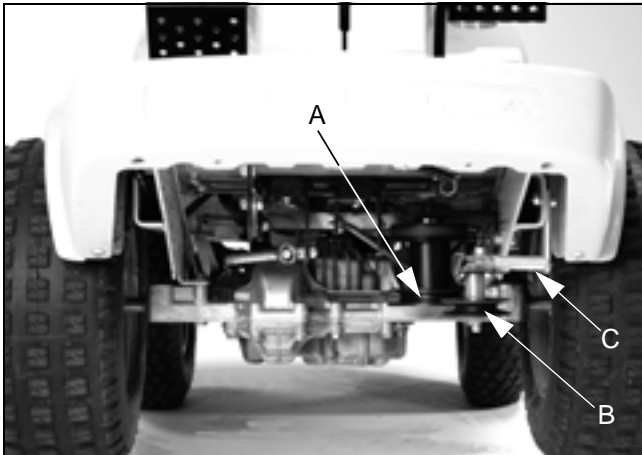

3.

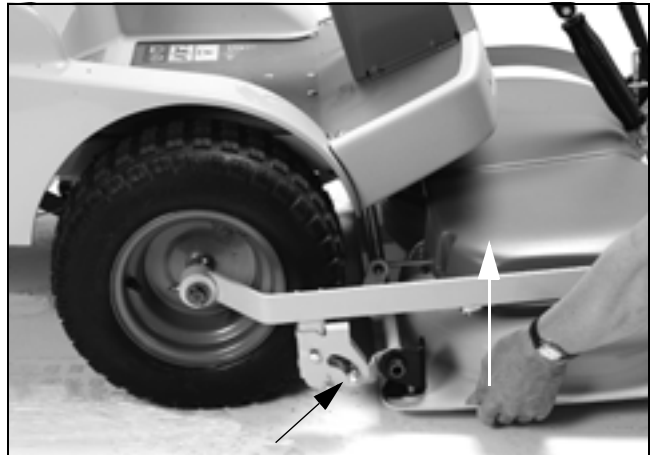

4.

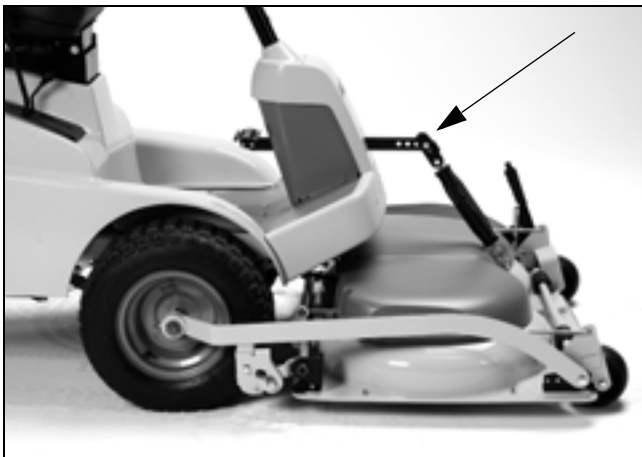

5.

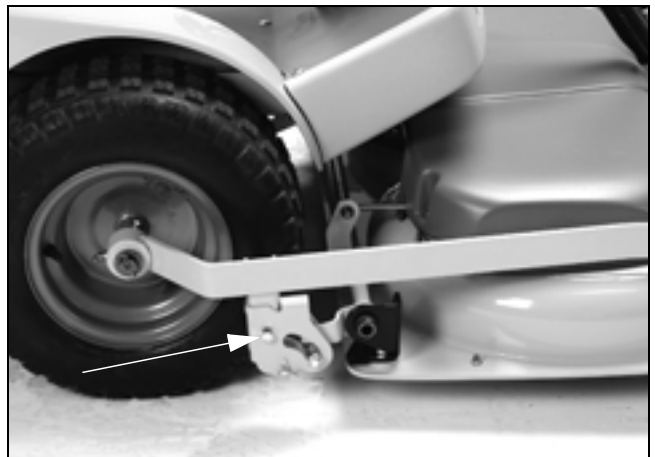

6.

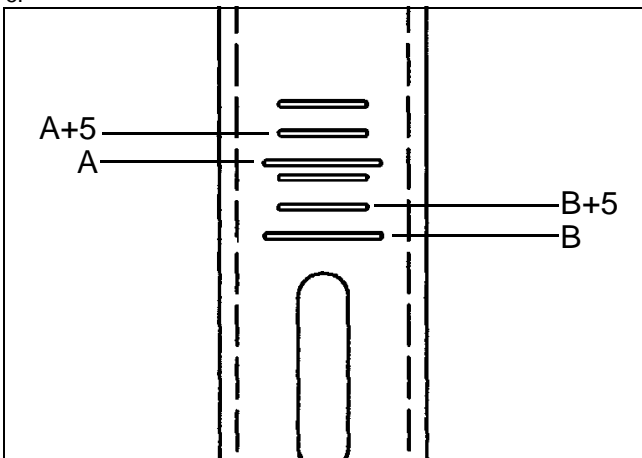

7.

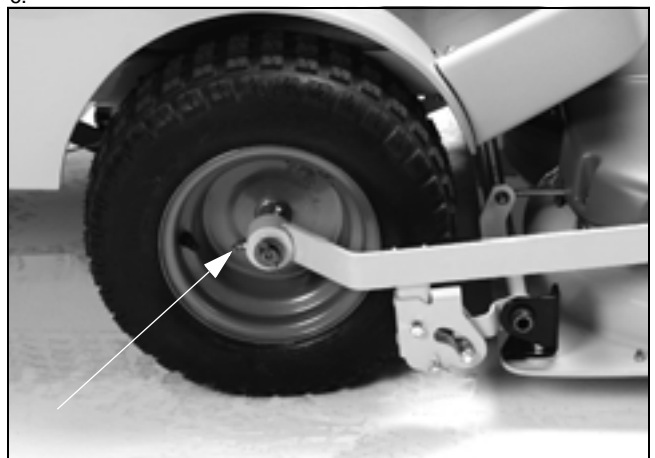

8.

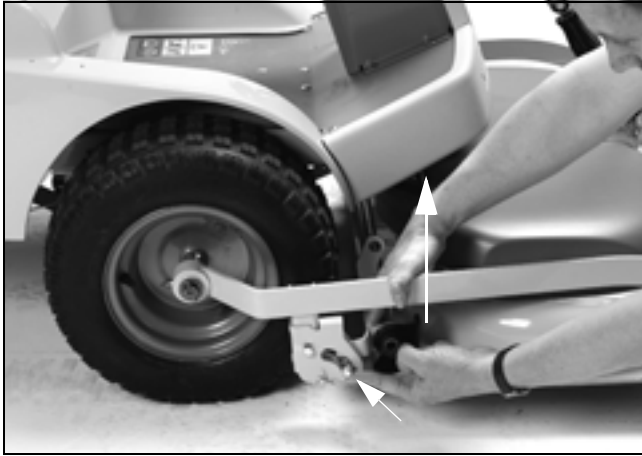

9.



10.

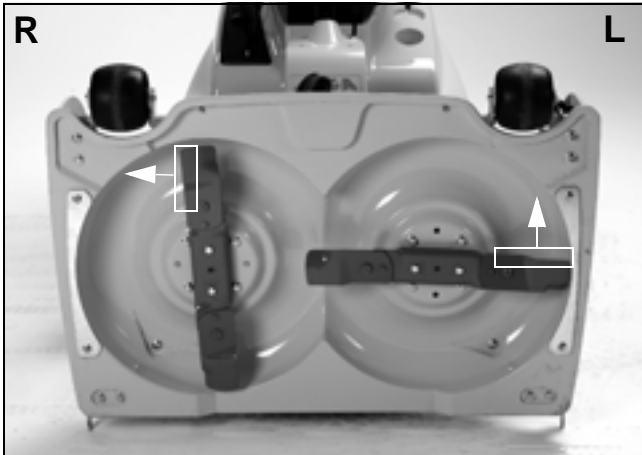

11.

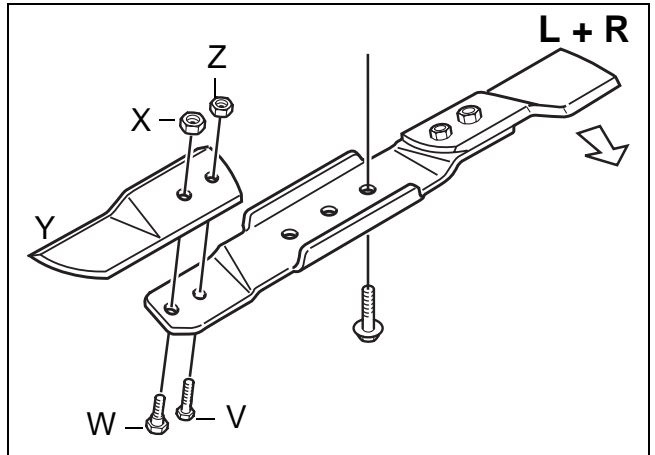

12.

## SYMBOLS

The following symbols can be found on the machine to remind you of the care and attention that are required during use.

The symbols mean:



Warning!  
Read the instruction manual and the safety manual before using the machine.



Warning!  
Do not insert your hands or feet under the cover when the machine is in operation.



Warning!  
Watch out for discarded objects. Keep onlookers away.



Warning!  
Before starting repair work, remove the spark plug cable from the spark plug.



## INTRODUCTION

### 107 M

This cutting deck is available as standard in two versions:

- with mechanical setting of the cutting height (item no. 13-2930).
- with factory-fitted, electrical setting of the cutting height (item no. 13-2934).

## INSTALLATION

### DECK ARMS

1. Install the left and right deck arms in the cutting deck's front two corners. Use the existing screw and flat washer (fig. 1). Tighten the screw. After tightening, it should be possible to move the deck arms up and down.

2. Do not hook the rear part of the deck arms onto the deck yet (See "Cutting deck" point 7 below).

### CUTTING DECK

1. Place the cutting deck in front of the machine. Set the maximum cutting height.

2. Remove the locking pin and the outermost flat washer from the machine's steering knuckle.

3. Thread one deck arm onto the steering knuckle. Place the flat washer on the steering knuckle and secure with the locking pin. Repeat on the other side (fig. 2).

4. Force the V-belt onto the machine's pulley A (fig. 3).

5. Lift up the deck's rear part past the catch until it drops down. When the weight of the deck is resting on the upper side of the catch, the installation is correct (fig. 4).

6. Tension the belt with belt idler B. The belt idler should be on the inside of the belt and pull out to the left (viewed from the driver's position).

7. Screw the lift spring into the machine's lifting arm. (fig. 5).

8. Connect the electrical contact to the socket on the side of the machine (only applies to item no. 13-2934), (fig. 6).

## SETTING

In order for the deck to cut evenly and attractively, it has to be correctly adjusted:

1. Make sure the air pressure in the tyres is correct:  
Front: 0.4 bar (6 psi).  
Rear: 1.2 bar (17 psi).

2. Place the machine on a level floor. Undo the screws on either side of the deck (fig. 6).

3. On the side of the deck arm are four short and two long lines. The upper long line (A) is the basic setting for a machine with 16" tyres. The lower (B) for a machine with 17" tyres (fig. 7).

*Note: Villa has 16" wheels.*

Depending on the length of the grass, the deck can be adjusted in various ways:

4a. Cutting normal length grass:

Adjust the deck so that the front and rear edge of the cover are the same height above the floor. This position gives the best 'Multiclip effect', i.e. the grass is cut up best.

4b. Cutting long grass:

Adjust the deck so that the cover's rear edge is higher than the front edge. This position means that the deck can release the grass more easily at the rear edge.

5. After setting, tighten the screws properly.

## USE

### CUTTING HEIGHT

The cutting height can be varied between a number of fixed positions, from 30 to 85 mm.

#### Item no. 13-2934:

The cutting height is continuously variable from 30 to 85 mm.

Note: Stated cutting heights apply when the machine is on a firm surface.

### CUTTING TIPS

For optimum 'Multiclip effect', follow these tips:

- cut frequently.
- run the motor at full revs.
- keep the underside of the cutting deck clean.
- use sharp blades.
- do not cut wet grass.
- cut twice (with different cutting heights) if the grass is long.

## SERVICE AND MAINTENANCE

### PREPARATIONS

Unless otherwise stated, all service and maintenance must be carried out on a stationary machine when the motor is not running.



**Prevent the machine from rolling by always applying the parking brake.**



**Prevent unintentional starting of the motor by always stopping the motor, disconnecting the spark plug cable from the spark plug and earthing it. Disconnect the negative cable from the battery.**

### LUBRICATION

The deck arms are equipped with grease nipples (fig. 8).

Lubricate these after every 25 hours of operation (or at least once per season) with universal grease.

### MAINTENANCE TIPS

To make cleaning and maintenance easier, the

cutting deck can be folded up:

1. Set the cutting height setting to the maximum cutting height.
2. Lift the rear edge of the deck with one hand (fig. 9).
3. Push up the catch and release the rear edge of the deck (fig. 9).
4. Repeat the procedure on the other side.
5. Secure the tensioning arm on the hook.
6. Force the belt off the machine's pulley.
7. Fold up the deck to the vertical position (fig. 10).

When the deck is folded down to working position, ensure that the catch drops down into position when the rear edge of the deck is lifted up (fig. 4).

### CLEANING

After each use, the underside of the cutting deck should be rinsed off.

If the grass has dried solid, scrape clean the underside.

If necessary, paint the underside to prevent corrosion.

### BLADES



**Use protective gloves when changing blades to avoid cutting yourself.**

Ensure that the blades are always sharp. This produces the best cutting results.

Always check the blades after a collision. If the blade system has been damaged, defective parts should be replaced.



**Always use original spare parts. Non-original spare parts can entail a risk of injury, even if they fit the machine.**

Install the blades according to fig. 11 where the blade edge is marked. The folded-up edge of the blade should be positioned inwards towards the blade mount.

The cutting system comprises two blade bars with two replaceable blades Y (fig. 12). When replacing blades, both should be replaced to avoid imbalance.

Install the new blades. Tighten screws V and W properly. Tightening torque: V - 9.8 Nm, W - 24

Nm.

In the event of a powerful collision, the blades may be bent out. Undo the locking nut X and fold back the blade. Install a new original break bolt V. Tighten the locking nuts X and Z.

## POSITIVE DRIVE BELT

Both blades are powered inside the deck by a positive drive belt.

If one of the blades has struck a solid object (e.g. a stone), the belt tension may be altered. This can lead to the positive drive belt 'over-meshing' which, in the long term, can damage the blades.



**Following a powerful collision, always check that both blades are at right-angles to each other (fig. 11).**

The working areas of the blades overlap each other. If the blades' position in relation to each other has been altered, there is a considerable risk of the blades striking each other. This can entail serious damage to the cutting deck.

If this is the case, take the machine and cutting deck to a service workshop for repair and inspection.

---

## SPARE PARTS

---

STIGA original spare parts and accessories are designed specifically for STIGA machines. Please note that 'non-original' spare parts and accessories have not been checked or approved by STIGA.



**The use of such parts and accessories can affect the function and safety of the machine. STIGA accepts no responsibility for damage or injuries caused by such products.**

---

## PATENT - DESIGN REGISTRATION

---

This machine or parts thereof is covered by the following patent and design registration:

9902299-8 (SE), SE/00/01222 (PCT)

*STIGA reserves the right to make alterations to the product without prior notification.*

## Free Manuals Download Website

<http://myh66.com>

<http://usermanuals.us>

<http://www.somanuals.com>

<http://www.4manuals.cc>

<http://www.manual-lib.com>

<http://www.404manual.com>

<http://www.luxmanual.com>

<http://aubethermostatmanual.com>

Golf course search by state

<http://golfingnear.com>

Email search by domain

<http://emailbydomain.com>

Auto manuals search

<http://auto.somanuals.com>

TV manuals search

<http://tv.somanuals.com>