

**STIGA**<sup>®</sup>



**COLLECTOR**

**45 COMBI EL**  
**45S COMBI EL**

71503821/0

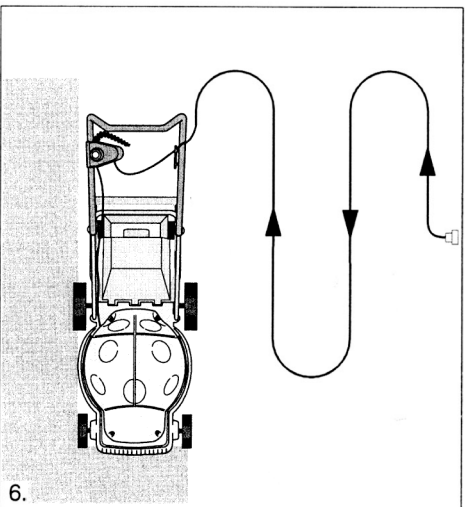
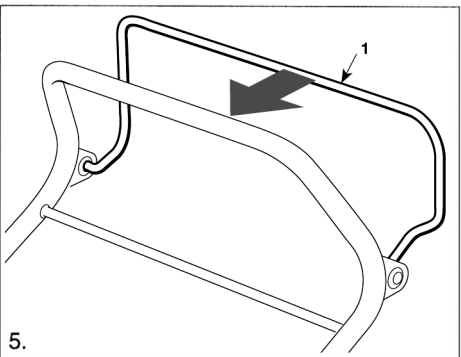
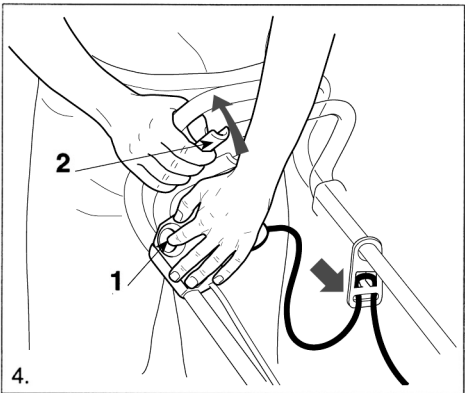
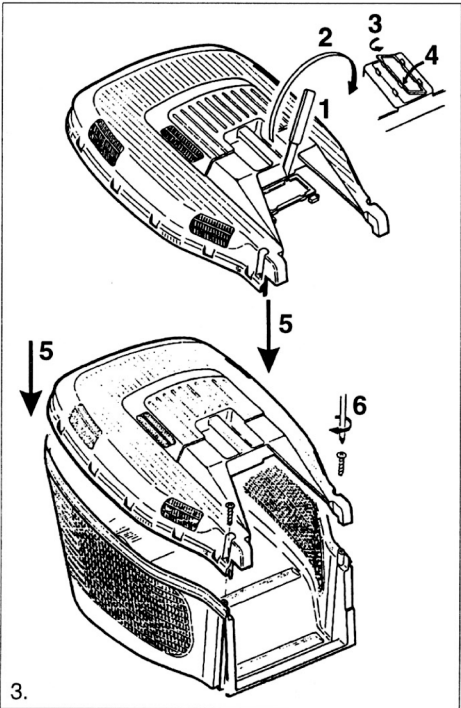
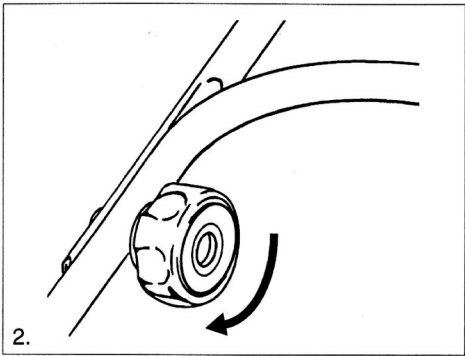
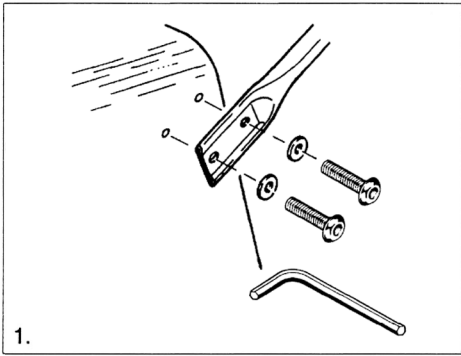

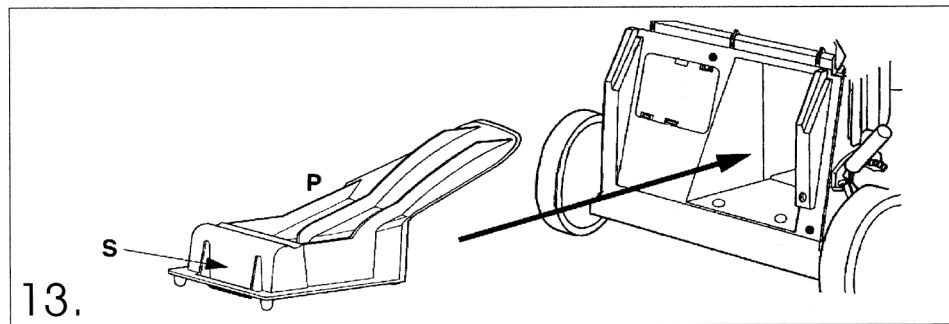
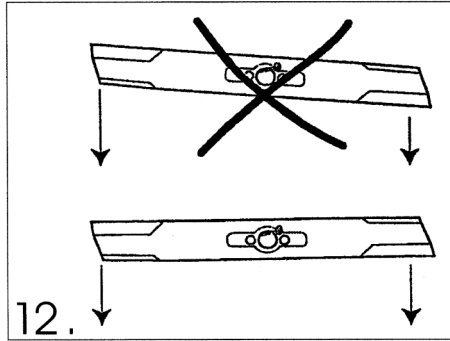
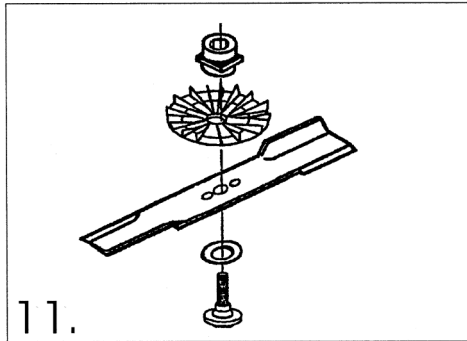
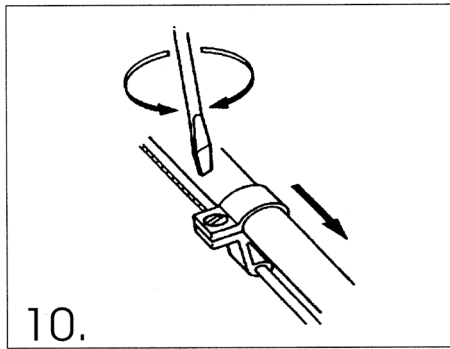
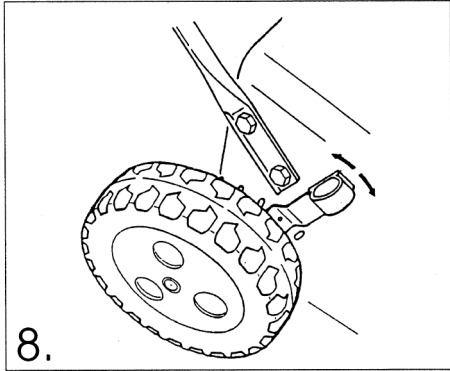
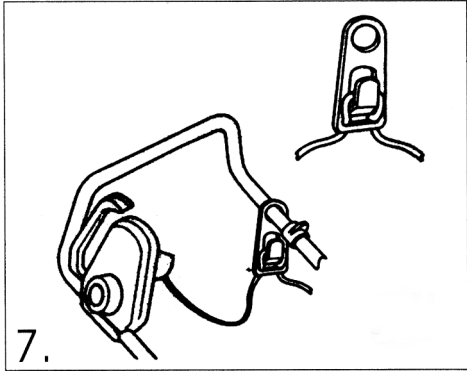

GB

ENGLISH

GB

## SAFETY REGULATIONS

### A) TRAINING

- 1) Read the instructions carefully. Get familiar with the controls and the proper use of the equipment. Learn how to stop the engine quickly.
- 2) Only use the lawnmower for the purpose for which it was designed, i.e. for cutting and collecting grass. Any other use can be hazardous, causing injury or damage to people and/or property.
- 3) Never allow children or people unfamiliar with these instructions to use the lawnmower. Local regulations may restrict the age of the operator.
- 4) Never use the lawnmower:
  - When people, especially children, or pets are nearby;
  - If the operator has taken medicine or substances that can affect his ability to react and concentrate.
- 5) Remember that the operator or user is responsible for accidents or hazards occurring to other people or their property.

### B) PREPARATION

- 1) While mowing, always wear sturdy footwear and long trousers. Do not operate the equipment when barefoot or wearing open sandals.
- 2) Thoroughly inspect the area where the equipment is to be used and remove all objects which may be thrown by the machine (stones, sticks, metal wire, bones, etc.)
- 3) Before use, always inspect the machine, especially the condition of the blades, and check that the screws and cutting assembly are not worn or damaged. Replace worn or damaged blades and screws in sets to preserve balance.
- 4) Before mowing, attach the discharge opening guards (grass-catcher or stone-guard).
- 5) **WARNING: DANGER!** Damp and electricity do not go together:
  - cables must be handled and wired when dry
  - never allow contact between an electric socket or cable with a wet area (puddles or damp grass);
  - connections between cables and sockets must be of the waterproof type. Only use extension cables with moulded-on waterproof or approved sockets available commercially.
  - power the machine using a residual current device (RCD Residual Current Device) with max. 30 mA tripping current.
- 6) The power supply cables must not be of lower quality than the H05RN-F or H05VV-F type with minimum cross-section size of 1.5 mm<sup>2</sup> and max. 25 m long.
- 7) Attach the cable onto the cable clamp before

starting the machine.

- 8) The permanent wiring of any electrical device to the mains must be carried out by a qualified electrician, in accordance with electrical regulations in force. Incorrect wiring may cause severe injury or death.

### C) OPERATION

- 1) Mow only in daylight or good artificial light.
- 2) Avoid operating the equipment on wet grass or in the rain.
- 3) Never go over the electric cable with the lawnmower. While cutting, the cable should always be pulled behind the lawnmower and always from the area of grass already cut. Use the cable clamp as described in this manual to prevent the cable from disconnecting by accident. Ensure that it is properly inserted without forcing into the power socket.
- 4) Never pull the lawnmower by its power cable or pull the cable to remove the plug. Do not expose the cable to sources of heat or let it come in contact with oil, solvents or sharp objects.
- 5) Always be sure of your footing on slopes.
- 6) Walk, never run and do not allow yourself to be pulled along by the lawnmower.
- 7) Mow across the face of slopes, never up and down.
- 8) Exercise extreme caution when changing direction on slopes.
- 9) Do not mow on slopes that are too steep.
- 10) Exercise extreme caution when pulling the lawnmower towards you.
- 11) Stop the blade if the lawnmower has to be tilted for transportation when crossing surfaces other than grass, and when transporting the lawnmower to and from the area to be mowed.
- 12) Never operate the lawnmower with defective guards, or without safety devices, such as the stone-guard and/or grass-catchers, in place.
- 13) On power-driven models, disengage the drive clutch before starting the engine.
- 14) Start the engine carefully, following the instructions and keeping feet well away from the blade.
- 15) Do not tilt the lawnmower when switching on the engine unless it is strictly necessary for start-up. In this case, do not tilt it more than is strictly necessary and only lift the part furthest away from the operator. Check that both hands are positioned correctly before lowering the lawnmower.
- 16) Do not put hands or feet near or under rotating parts. Keep clear of the discharge opening at all times.
- 17) Never pick up or carry a lawnmower while the engine is running.
- 18) Stop the engine and disconnect the power supply cable:
  - before carrying out any work underneath the

GB

ENGLISH

GB

cutting deck or before unclogging the chute;

- before checking, cleaning or working on lawnmower;
- after striking a foreign object. Inspect the lawnmower for damage and make repairs before restarting and operating the lawnmower;
- if the lawnmower starts to vibrate abnormally, find and remove the cause of the vibration immediately;
- whenever you leave the lawnmower unattended.
- when transporting the equipment.

19) Stop the engine:

- every time you remove or replace the grass-catcher.
- before adjusting the grass cutting height.

20) When mowing, always keep to a safe distance from the rotating blade. This distance is the length of the handle.

#### D) MAINTENANCE AND STORAGE

- 1) Keep all nuts, bolts and screws tight to be sure the equipment is in safe working condition. Regular maintenance is essential for safety and performance.
- 2) To reduce the fire hazard, keep the lawnmower, especially the engine, free of grass, leaves, or excessive grease. Do not leave containers with grass cuttings in rooms.
- 3) Check the stone-guard and grass-catcher frequently for wear and deterioration.
- 4) Periodically check the electric cables and replace them if they are damaged or if the insulation has been damaged. Never touch a badly insulated cable if it still connected to the power supply. Remove the cable from the socket before taking any action.
- 5) Wear strong work gloves when removing and reassembling the blade.
- 6) Check the blade's balance after sharpening.

#### THE ENVIRONMENT

In order to protect the environment, we recommend that the following points should be given special consideration:

- Do not dispose of used lead-acid batteries in a garbage bin. Take them to a battery collection point for recycling (applies to battery-powered machines and machines with battery start).
- When, after many years of service, your machine needs to be replaced or is no longer required, we recommend that the machine is returned to your distributor for recycling.

#### SERVICE

##### ACCESSORIES/SPARE PARTS



Always use genuine spare parts and accessories. Non-genuine spare parts and accessories have not been checked and approved by the lawnmower manufacturer. Use of non-genuine spare parts and accessories can lead to the risk of injury even if they fit the machine. The lawnmower manufacturer does not accept any liability for injuries caused by the use of such parts or accessories.

Genuine spare parts are stocked by authorised service centres and by many dealers.

We recommend that you take the machine to an authorised service centre for annual servicing, maintenance and inspection of safety equipment.

For servicing and spare parts contact your distributor.

#### PRODUCT IDENTITY

The identity of the product is determined by the article and serial numbers of the machine.

These can be found on the label fixed to the chassis of the machine:

ART. NR. →

SERIE NR. →

Model: .....	CE	LWA
Type: .....	dB	
(Year).....	S/N°.....	

Use this identification whenever you contact a service centre or buy replacement parts.

After buying the machine, write the above numbers on the back page of this booklet as soon as possible.

The manufacturer reserves the right to make changes to the product without prior notice.

GB

ENGLISH

GB

## SYMBOLS

The following symbols are displayed on the machine in order to remind you about the safety precautions and attention necessary when using the machine.

The symbols mean:



Warning! Read the Instruction Book and Safety Manual before using the machine.



Warning! Keep spectators away. Beware of objects being flung out.



Warning! Before starting any repair work, disconnect the plug from the wall socket.



Warning! Keep the extension cord away from the blade.



Warning! Do not put hands or feet under the cover of the machine when it is running.



Warning! The blade continues to rotate even after the machine has been switched off.



## IMPORTANT

Equipment marked with an asterisk (\*) is included as standard equipment only for certain models or specific country versions.

## ASSEMBLING

### STEERING

Fold up the handle. By tightly screwing the lower part of the handle into the steering sockets' lower or upper holes (A or B), the steering height can be adapted to suit the operator (fig. 1).

Tighten the locking knobs to fix the upper part of the handle (fig. 2).

### GRASS COLLECTOR

Assemble the grass collector (fig. 3). Open the cover and place the grass collector in the ejector opening on the mower.

Note! The lawn mower can be used without the grass collector. The grass will then collect in a bead behind the machine.

### MULTICLIP

When delivered, the machine is equipped with a plug (P) mounted in the grass evacuation opening (fig. 13). The machine can be used for "Multiclip", i.e. when cutting the grass is finely chopped by the blade. The grass is then spread into the lawn where it decomposes. In this way, nutrients are put back into the lawn.

To remove the plug, press in the catch (S). When remounting the plug, make sure that both the pins are pressed down into the holes, so that the plug snaps into place.

## USING THE MOWER

### CONNECTING

Connect the machine to an earthed, single phase electric socket.

Check that the extension cable is not damaged, each time before using the machine. The machine may not be used if the extension cable is damaged. Relieve the extension cable in the load relief unit on the steering handle (fig. 7).

We recommend that you use a residual current circuit breaker (RCB) previously known as earth leakage circuit breaker. It will cut off the power if anything happens to the machine or the extension lead. If you use a portable RCB this must be fitted between the electric socket and the extension lead. Test the operation of the RCB before use.

If uncertain, contact your retailer.

### START/STOP OF MOTOR



**Keep hands and feet well away from the rotating blade(s). Never put your hand or foot under the blade casing or in the grass evacuation unit while the motor is running.**

When starting up the motor, press the handlebar to lift the front wheels and in that way reduce the resistance from the grass at the starting moment.

Do not engage and dis-engage the motor repeatedly since this will build up heat because of the high current when starting, and this could, consequently, cause motor damages.

Press the block button 1. Start the motor by pressing in the starter grip 2 against the handle bar (fig. 4). Release the starter grip to stop the motor.

GB

ENGLISH

GB

## OVERLOADING THE MOTOR (\*)

The lawn mower has an integrated overload protector. If this trips the motor will not start. Let the motor cool for 2 minutes before restarting.

If the mower still does not start, contact an authorised service workshop.

## DRIVE (\*)

Connect the drive by pressing in the clutch lever towards the handle bar. Disconnect the drive by releasing the clutch lever (fig. 5).

## MOWING TIPS

Always mow so the cable is laid out behind you on the grass (fig. 6).



**Never cross the cable! Should this happen by accident, stop the motor, pull out the plug and check if the cable is damaged.**

Before mowing the lawn, take care to remove any stones toys and other hard objects.

Empty the grass collector in good time so that the grass deflector does not get blocked and reduce grass collection capacity.

To avoid overloading the motor, do not push the mower too quickly in long grass.

Always use a well sharpened blade.

Do not use the mower when it is raining or when the grass is wet.

## CUTTING HEIGHT



**Do not set the cutting height so low that the blade/ blades can hit uneven ground. When adjusting the cutting height - always first disconnect the plug.**

The mower is fitted with a single lever control for adjusting the cutting height. Pull the lever outwards and adjust the cutting height to the position which is most suitable for your lawn (fig. 8).

## CLEANING

In order to function properly the motor must be effectively cooled. This is done by a fan which sucks in air at the air intake on the motor casing (fig. 9).

To make sure that the cooling system functions properly the air intake must be thoroughly cleaned if it has become blocked.

The machine should be cleaned each time after use. For best possible mowing results it is important that the underside of the chassis is kept clean. Use a

brush or blow with compressed air.

The machine must not be washed down with water.

## MAINTENANCE

### CLUTCH CABLE (\*)

If the clutch lever is pressed in but the mower still does not move, the clutch cable must be adjusted. Loosen the cable attachment and move it downwards to stretch the clutch cable (fig. 10). Do not stretch the cable so hard that the clutch lever, cable or transmission risks being damaged.

### CHANGING BLADE



**You must never service the motor or the lawn mower before first shutting off the motor and pulling out the plug.**

**Use protective gloves to prevent cuts when changing blades/knifeblades.**

Blunt and damaged blades tear off the grass and spoil the look of the lawn after mowing. New, well sharpened blades cut the grass cleanly, so that the lawn looks green and fresh even after mowing.

To change the blade, loosen the blade bolt. Mount the new blade so that it sits in the same way as the old one and tighten the blade bolt (fig. 11). Tightening torque: 20 Nm.

When replacing the blade, the blade bolt should also be replaced.

The guarantee does not cover damage to the blade, blade holder or motor caused by running into obstacles.

When replacing the blade, the blade holder and blade bolt, always use original spare parts. Non-authentic spare parts could lead to the risk of personal injury or damage, even if they fit the machine.

### SHARPENING THE BLADE

Sharpening of the blade must be done by wet method grinding, using a whetstone or a grindstone.

For the sake of safety, the blade should not be sharpened on an emery wheel. A very high temperature could cause the blade to become brittle.







**Once the blade has been sharpened, it must then be balanced so as to avoid vibration damage (fig. 12).**

### STORAGE

Thoroughly clean the mower and store it indoors in a dry place.



_____		 <b>LWA</b>
Model: .....		
Type: .....	 	 <b>dB</b>
_____		
(Year). ....	S/N° .....	

**GGP ITALY SPA** • Via del lavoro,6 • I-31033 Castelfranco Veneto (TV) - ITALY





## Free Manuals Download Website

<http://myh66.com>

<http://usermanuals.us>

<http://www.somanuals.com>

<http://www.4manuals.cc>

<http://www.manual-lib.com>

<http://www.404manual.com>

<http://www.luxmanual.com>

<http://aubethermostatmanual.com>

Golf course search by state

<http://golfingnear.com>

Email search by domain

<http://emailbydomain.com>

Auto manuals search

<http://auto.somanuals.com>

TV manuals search

<http://tv.somanuals.com>