

36" (914) Framed Electric Cooktop

MODEL CT36E

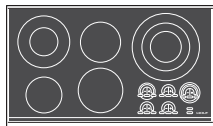

Model CT36E

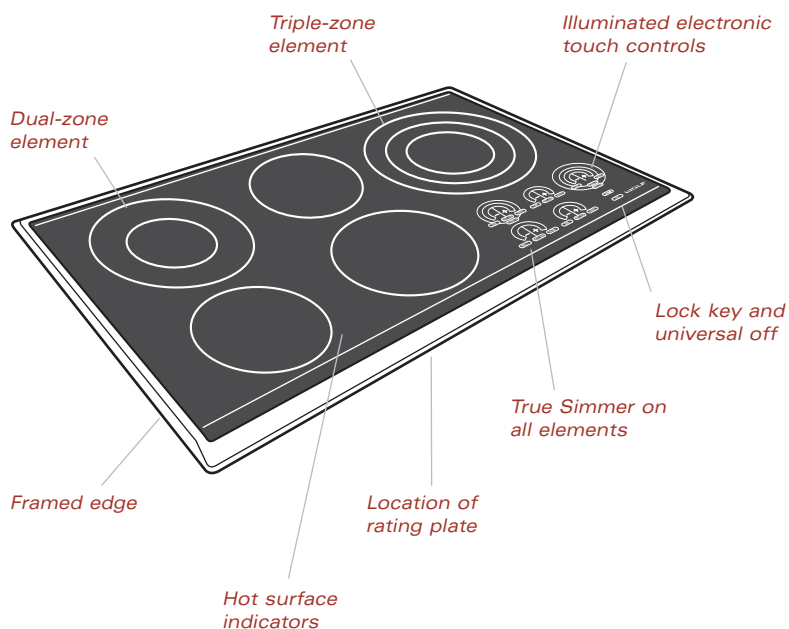

► The Wolf Model CT36E 36" (914) framed electric cooktop is available with the classic, platinum or carbon stainless steel trim finish.



This appliance is certified by Star-K to meet strict religious regulations in conjunction with specific instructions found on www.star-k.org.

Behind the sophisticated, minimalist exterior, beneath that perfectly smooth, subtly patterned glass that cleverly reduces scratches, there is a high-performance cooking tool.

The black ceramic glass top is beautifully complemented by your choice of classic, platinum or carbon stainless steel trim finish.

Multiple cooking elements with different zones offers exceptional control of temperature for pans and pots of every size. All of the heating elements offer True Simmer along with one element that enables you to set a temperature for melting.

Let Wolf, the corporate companion and kitchen soul mate of Sub-Zero, fuel your passion for cooking and kitchen design.

36" (914) Framed Electric Cooktop

MODEL CT36E

FEATURES

- ▶ Classic, platinum and carbon stainless steel trim finishes
- ▶ Easy-to-clean black ceramic glass surface is resistant to scratching, staining, impact and heat—translucent surface allows you to see the glow of hot elements
- ▶ Illuminated electronic touch controls with graduated control lighting
- ▶ Five ribbon-type radiant heating elements with eight temperature zones
- ▶ Triple-zone and dual-zone elements for flexible cooking
- ▶ True Simmer setting on all elements
- ▶ Melt setting on one element
- ▶ Hot surface indicators on all elements
- ▶ High frequency pulsation elements improve cooking performance and control
- ▶ Temperature limiter to ensure that safe operating temperature of ceramic glass is never exceeded
- ▶ Child safety lock key and universal off
- ▶ Certified by Star-K to meet religious regulations
- ▶ CSA certified for US and Canada
- ▶ Two and five year residential warranty – exclusions apply; warranty information can be found on our website, wolfappliance.com

OVERALL DIMENSIONS ▼

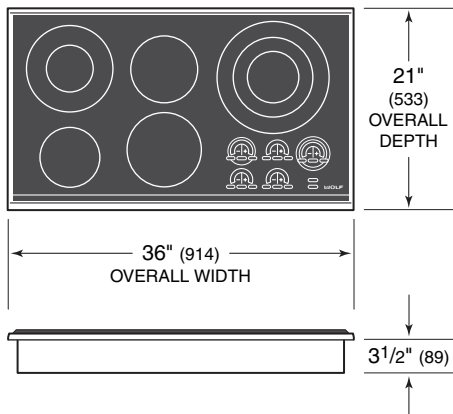

Dimensions may vary by $\pm 1/8$ " (3).

Dimensions in parentheses are in millimeters unless otherwise specified.

36" (914) Framed Electric Cooktop

MODEL CT36E

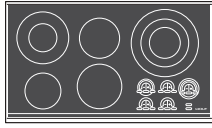

Model CT36E

MODEL OPTIONS ▼

Classic Stainless Trim	CT36E/S
Platinum Stainless Trim	CT36E/P
Carbon Stainless Trim	CT36E/B

VENTILATION OPTIONS

- ▶ 36" (914) Cooktop or Pro wall hood or liner
- ▶ 36" (914) downdraft ventilation system
- ▶ 42" (1067) Cooktop or Pro island hood

For additional information, refer to the Wolf Cooktop Ventilation or Pro Ventilation sections of our website, wolfappliance.com.

ACCESSORIES

- ▶ Filler strip

Accessories are available through your Wolf dealer. To obtain local dealer information, visit the Locator section of our website, wolfappliance.com.

SPECIFICATIONS ▼

Overall Cooktop Width	36" (914)
Overall Cooktop Height	3 1/2" (89)
Overall Cooktop Depth	21" (533)
Cooktop Cut-Out Width	34 3/8" (873)
Cooktop Cut-Out Depth	19 1/4" (489)
Minimum Cabinet Depth	22 3/4" (578)
Heating Element Maximum Power	(1) Triple – 2700 W outer / 2200 W middle / 1050 W inner (1) Dual – 2200 W outer / 750 W inner (3) Single – 1800 W, 1500 W and 1200 W
Heating Element Outer Diameter	(1) Triple – 11 7/8" (302) (1) Dual – 9 1/8" (232) (3) Single – 7 7/8" (200), 7 1/8" (181) and 6 1/2" (165)
Electrical Supply Requirements	240 V AC / 60 Hz / 50 amp 208 V AC / 60 Hz / 40 amp
Conduit	4 ft (1.2 m) flexible 3-wire
Electric Rating	9.4 kW at 240 V 7.1 kW at 208 V
Shipping Weight	60 lbs (27 kg)
Special Note	Cooktop can be installed above a Wolf built-in single oven

Specifications are subject to change without notice.

36" (914) Framed Electric Cooktop
MODEL CT36E

INSTALLATION SPECIFICATIONS

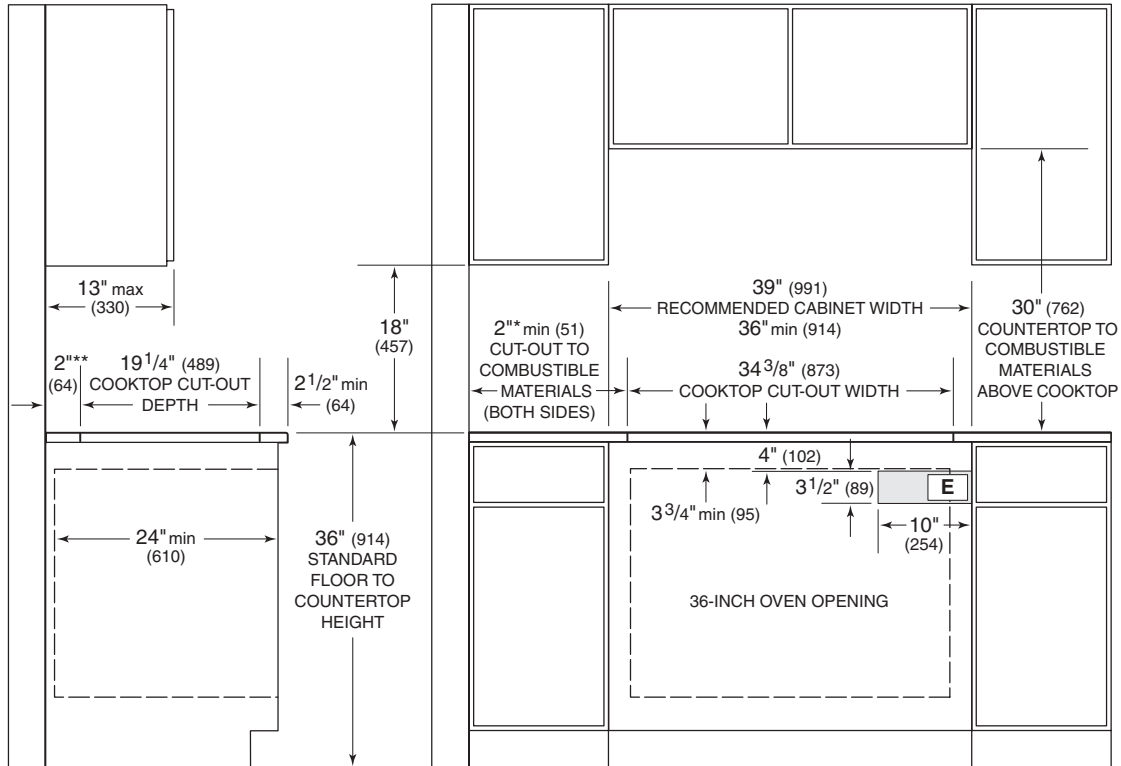

**Minimum clearance from both side edges of cooktop cut-out to combustible materials up to 18" (457) above countertop. **Minimum clearance from rear edge of cooktop cut-out to combustible materials up to 18" (457) above countertop.*

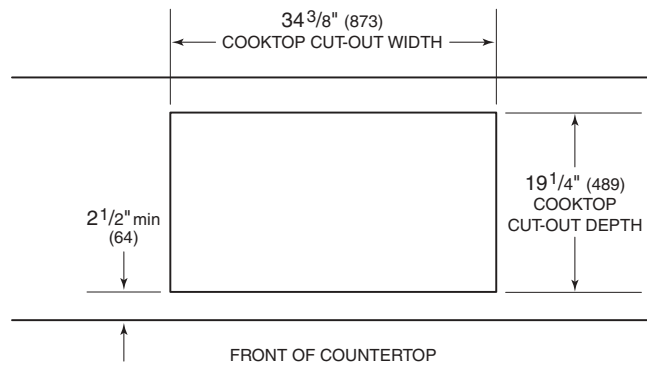

DIMENSIONS

Cooktop Cut-Out Width	34 ³ / ₈ " (873)
Recommended Cabinet Width	39" (991)
Cooktop Cut-Out Depth	19 ¹ / ₄ " (489)
Minimum Cabinet Depth	22 ³ / ₄ " (578)
Location of Electrical	Within shaded area

See Installation Instructions shipped with unit for detailed specifications.

36" (914) Framed Electric Cooktop

MODEL CT36E

INSTALLATION NOTES

- ▶ Refer to the illustrations and specifications for overall dimensions, cut-out dimensions and installation specifics.
- ▶ Wolf recommends using 39" (991) cabinets with the 36" (914) cooktop.
- ▶ A Wolf downdraft system, Cooktop or Pro ventilation hood is recommended. When installing a ventilation hood, refer to the specific requirements of the hood for the minimum dimension to the countertop. Also refer to Ventilation Recommendations in the Cooktop Ventilation or Pro Ventilation sections of our website, wolfappliance.com.
- ▶ The Wolf 36" (914) framed electric cooktop requires a separate, grounded 3-wire 240 V AC, 60 Hz, 50 amp or 208 V AC, 60 Hz, 40 amp service with its own circuit breaker. It is provided with a 4' (1.2 m) flexible 3-wire conduit for connection at the electrical supply. Locate electrical within the shaded area shown in the Installation Specifications illustration on page 4.

IMPORTANT NOTE: A ground fault circuit interrupter (GFCI) is not recommended and may cause interruption of operation.

- ▶ A Wolf 36" (914) or 30" (762) built-in single oven may be installed below this cooktop. For this installation, the electrical supply for the cooktop should be installed in the adjacent cabinet. Refer to page 6 for additional specifications. Be aware of the depth of the cooktop when planning for this installation.

IMPORTANT NOTE: Wolf electric cooktops are designed and agency approved for installation with Wolf built-in ovens only.

IMPORTANT NOTE: When a built-in oven is installed below the cooktop, unless you are using cabinets deeper than 24" (610), it is recommended that the electrical supply for the oven be placed in an adjacent cabinet within reach of the conduit. A 2" (51) diameter hole to route the conduit through cabinetry will be required. Refer to page 6 for location of electrical supply and additional specifications.

- ▶ You must follow all National Electrical Code regulations. In addition, be aware of local codes and ordinances when installing your service.
- ▶ When a 36" (914) oven is installed below a cooktop, it is recommended that the rough opening for the oven be 7³/₄" (197) from the floor to ease the use of the oven door. The bottom cabinet support must be able to support 250 lbs (113 kg).
- ▶ If the 36" (914) framed electric cooktop is to be used with any combination of additional cooktop units or modules with a filler strip, the cut-out width increases to 35" (889). When multiple cooktop units or modules are installed side by side, refer to the countertop cut-out dimensions on page 7.
- ▶ Refer to the installation instructions shipped with each Wolf product for detailed specifications.

▲ WARNING

This cooktop is intended for indoor use only.

36" (914) Framed Electric Cooktop

MODEL CT36E

INSTALLATION OF 36" ELECTRIC COOKTOP ABOVE A BUILT-IN OVEN

A Wolf 36" (914) framed electric cooktop may be installed above the Wolf 36" (914) built-in single oven. Refer to the illustration below for specifications for this installation.

IMPORTANT NOTE: When a oven is installed below the cooktop, unless you are using cabinets deeper than 24" (610), it is recommended that the electrical supply for the oven and the electrical supply for the cooktop be located in the adjacent right side cabinet. A 2" (51) diameter hole to route the conduit through cabinetry will be required.

IMPORTANT NOTE: Wolf electric cooktops are designed and agency approved for installation with Wolf built-in ovens only.

Wolf recommends using 39" (991) wide cabinets for this installation. A minimum 24" (610) of usable cabinet depth is required. The cabinet base must be able to support 250 lbs (113 kg). It is recommended that the rough opening for the oven be 7³/₄" (197) from the floor to ease use of the oven door.

A Wolf 36" (914) framed electric cooktop may also be installed above the Wolf 30" (762) single oven.

For electrical requirements and additional specifications for the built-in oven, refer to the Built-In Ovens section of our website, wolfappliance.com.

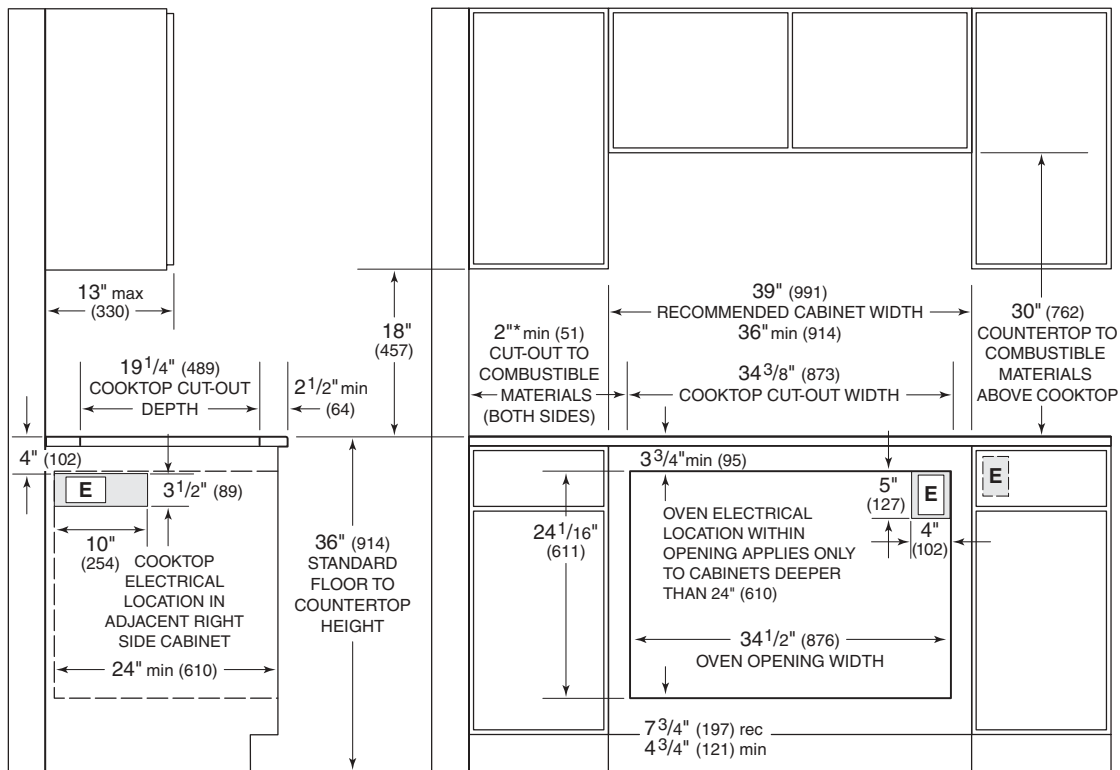

*Minimum clearance from both side edges of cooktop cut-out to combustible materials up to 18" (457) above countertop. Unless you are using cabinets deeper than 24" (610), the electrical supply for the oven and the electrical supply for the cooktop should be located in the adjacent right side cabinet as shown.

Installation specifications for a 36" (914) framed electric cooktop installed above a 36" (914) built-in oven.

Dimensions in parentheses are in millimeters unless otherwise specified.

36" (914) Framed Electric Cooktop

MODEL CT36E

INTEGRATED MODULES— MULTIPLE UNIT INSTALLATION

With Wolf's integrated modules, you have the ultimate in customization. You can create your own design by mixing and matching the various components within this system. And when you couple these modules with other cooktops within the Wolf inventory you and your client will truly understand freedom of choice.

Some Wolf integrated modules can be installed together or with a 30" (762) or 36" (914) cooktop. When multiple units are installed side by side, the cut-out dimensions that are shown in the illustration are derived by adding 1 1/4" (32) additional space for each additional unit, to give you your total cut-out width. Refer to the illustration below for countertop cut-out dimensions for installation of multiple cooktops.

IMPORTANT NOTE: Refer to the pages for each specific integrated module for installation limitations.

IMPORTANT NOTE: Where multiple cooktops and/or modules are installed side by side, each unit must have its own separate recommended electrical circuit.

When two or more cooktops or modules are installed together, an integrated module filler strip is recommended. Contact your Wolf dealer for information on this accessory component.

For electrical requirements, additional specifications and installation limitations, refer to the **Integrated Modules** pages on our website, wolfappliance.com.

IMPORTANT NOTE: Review specific installation instructions for product to product capabilities.

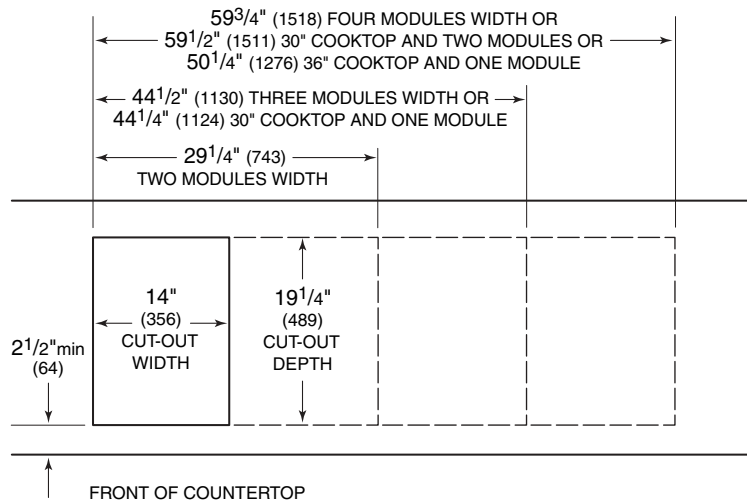

Countertop cut-out dimensions for installation of multiple cooktop units.

Dimensions in parentheses are in millimeters unless otherwise specified.

Free Manuals Download Website

<http://myh66.com>

<http://usermanuals.us>

<http://www.somanuals.com>

<http://www.4manuals.cc>

<http://www.manual-lib.com>

<http://www.404manual.com>

<http://www.luxmanual.com>

<http://aubethermostatmanual.com>

Golf course search by state

<http://golfingnear.com>

Email search by domain

<http://emailbydomain.com>

Auto manuals search

<http://auto.somanuals.com>

TV manuals search

<http://tv.somanuals.com>