

SUPER[®]

SUPER[®] X7DA3+

USER'S MANUAL

Revision 1.0a

The information in this User's Manual has been carefully reviewed and is believed to be accurate. The vendor assumes no responsibility for any inaccuracies that may be contained in this document, makes no commitment to update or to keep current the information in this manual, or to notify any person or organization of the updates. **Please Note: For the most up-to-date version of this manual, please see our web site at www.supermicro.com.**

Super Micro Computer, Inc. ("Supermicro") reserves the right to make changes to the product described in this manual at any time and without notice. This product, including software, if any, and documentation may not, in whole or in part, be copied, photocopied, reproduced, translated or reduced to any medium or machine without prior written consent.

IN NO EVENT WILL SUPERMICRO BE LIABLE FOR DIRECT, INDIRECT, SPECIAL, INCIDENTAL, SPECULATIVE OR CONSEQUENTIAL DAMAGES ARISING FROM THE USE OR INABILITY TO USE THIS PRODUCT OR DOCUMENTATION, EVEN IF ADVISED OF THE POSSIBILITY OF SUCH DAMAGES. IN PARTICULAR, SUPERMICRO SHALL NOT HAVE LIABILITY FOR ANY HARDWARE, SOFTWARE, OR DATA STORED OR USED WITH THE PRODUCT, INCLUDING THE COSTS OF REPAIRING, REPLACING, INTEGRATING, INSTALLING OR RECOVERING SUCH HARDWARE, SOFTWARE, OR DATA.

Any disputes arising between manufacturer and customer shall be governed by the laws of Santa Clara County in the State of California, USA. The State of California, County of Santa Clara shall be the exclusive venue for the resolution of any such disputes. Supermicro's total liability for all claims will not exceed the price paid for the hardware product.

FCC Statement: This equipment has been tested and found to comply with the limits for a Class B digital device pursuant to Part 15 of the FCC Rules. These limits are designed to provide reasonable protection against harmful interference in a residential installation. This equipment generates, uses, and can radiate radio frequency energy and, if not installed and used in accordance with the manufacturer's instruction manual, may cause interference with radio communications. However, there is no guarantee that interference will not occur in a particular installation. If this equipment does cause harmful interference to radio or television reception, which can be determined by turning the equipment off and on, you are encouraged to try to correct the interference by one or more of the following measures: Reorient or relocate the receiving antenna. Increase the separation between the equipment and the receiver. Connect the equipment into an outlet on a circuit different from that to which the receiver is connected. Consult the dealer or an experienced radio/television technician for help.

California Best Management Practices Regulations for Perchlorate Materials: This Perchlorate warning applies only to products containing CR (Manganese Dioxide) Lithium coin cells. "Perchlorate Material-special handling may apply. See www.dtsc.ca.gov/hazardouswaste/perchlorate"

WARNING: Handling of lead solder materials used in this product may expose you to lead, a chemical known to the State of California to cause birth defects and other reproductive harm.

Manual Revision: Rev. 1.0a

Release Date: April 4, 2008

Unless you request and receive written permission from Super Micro Computer, Inc., you may not copy any part of this document.

Information in this document is subject to change without notice. Other products and companies referred to herein are trademarks or registered trademarks of their respective companies or mark holders.

Copyright © 2008 by Super Micro Computer, Inc.

All rights reserved.

Printed in the United States of America

Preface

About This Manual

This manual is written for system integrators, PC technicians and knowledgeable PC users. It provides information for the installation and use of the **SUPER** X7DA3+ motherboard. The **SUPER** X7DA3+ supports dual Intel Quad-Core and Dual-Core processors with a front side bus speed of 1.333 GHz/1.066 GHz/667 MHz. With two 64-bit Quad-Core and Dual-Core processors built-in, the X7DA3+ offers substantial functionality enhancements to the motherboards based on the Intel Quad-Core/Dual-Core architecture while remaining compatible with the IA-32 software. The features include the Intel Virtualization Technology, Hyper Pipelined Technology, Execution Trace Cache, Thermal Monitor 1/2 (TM1/TM2), Enhanced Intel SpeedStep technology, Advanced Dynamic Execution, Advanced Transfer Cache, Streaming SIMD Extensions 3 (SSE3) and Extended Memory 64 Technology (EM64T). These features allow the motherboard to operate at much higher speeds with better power management in much safer thermal environments than the traditional motherboards. The X7DA3+ is ideal for high performance quad processor or dual processor workstation and enterprise server environments. Refer to our web site (<http://www.supermicro.com/products/>) for updates on supported processors. This product is intended to be professionally installed.

Manual Organization

Chapter 1 describes the features, specifications and performance of the motherboard and provides detailed information about the chipset.

Chapter 2 provides hardware installation instructions. Read this chapter when installing the processor, memory modules and other hardware components into the system. If you encounter any problems, see **Chapter 3**, which describes troubleshooting procedures for the video, the memory and the system setup stored in CMOS.

Chapter 4 includes an introduction to BIOS and provides detailed information on running the CMOS Setup utility.

Appendix A and **Appendix B** provide BIOS POST Messages and POST Codes. **Appendix C, Appendix D and Appendix E** list HostRAID, Windows OS and Other Software Program Installation Instructions.

Conventions Used in the Manual

Special attention should be given to the following symbols for proper installation and to prevent damage done to the components or injury to yourself:



Danger/ Caution: Instructions to be strictly followed to prevent catastrophic system failure or to avoid bodily injury.



Warning: Important information given to ensure proper system installation or to prevent damage to the components.

Note: Additional Information given to differentiate various models or to ensure correct system setup.

Table of Contents

Preface

About This Manual	iii
Manual Organization	iii
Conventions Used in the Manual	iii

Chapter 1: Introduction

1-1 Overview	1-1
Checklist	1-1
Contacting Supermicro	1-2
SUPER [®] X7DA3+ Image	1-3
SUPER [®] X7DA3+ Layout	1-4
Quick Reference	1-5
Motherboard Features.....	1-6
Intel 5000X (Green creek) Chipset: System Block Diagram	1-8
1-2 Chipset Overview	1-9
1--3 Special Features	1-10
1-4 PC Health Monitoring	1-10
1-5 ACPI Features	1-11
1-6 Power Supply	1-12
1-7 Super I/O	1-12

Chapter 2: Installation

2-1 Static-Sensitive Devices	2-1
Precautions.....	2-1
Unpacking	2-1
2-2 Motherboard Installation	2-1
2-3 Processor and Heatsink Installation	2-2
2-4 Installing DIMMs	2-6
2-5 Control Panel Connectors and IO Ports	2-8
A. Back Panel Connectors/IO Ports.....	2-8
B. Front Control Panel.....	2-9
C. Front Control Panel Pin Definitions	2-10
NMI Button	2-10
Power LED	2-10
HDD LED	2-11
NIC1/NIC2 LED Indicators	2-11
Overheat/Fan Fail LED	2-12
Power Fail LED	2-12

	Reset Button	2-13
	Power Button	2-13
2-6	Connectors and Headers.....	2-14
	ATX Power Connector	2-14
	Processor Power Connector	2-14
	Universal Serial Bus (USB).....	2-15
	Chassis Intrusion	2-15
	Fan Headers	2-16
	ATX PS/2 Keyboard and Mouse Ports.....	2-17
	Serial Port	2-17
	Wake-On-Ring.....	2-18
	Wake-On-LAN	2-18
	GLAN 1/2 (Ethernet) Ports.....	2-19
	Speaker/Power LED Header	2-19
	Power Fault	2-20
	Overheat/Fan Fail LED	2-20
	SMB Connector.....	2-21
	Power SMB Connector.....	2-21
	Compact Flash Card PWR Connector.....	2-22
	SGPIO Headers	2-22
	High Definition Audio.....	2-23
	CD Connector.....	2-23
2-7	Jumper Settings	2-24
	Explanation of Jumpers	2-24
	GLAN Enable/Disable	2-24
	CMOS Clear	2-25
	Watch Dog.....	2-25
	3rd PWR Supply PWR Fault.....	2-26
	SAS Controller Enable	2-26
	Compact Flash Master/Slave Enable/Disable.....	2-27
	Alarm Reset.....	2-27
	SMB to PCI-X/PCI-E Slots	2-28
2-8	Onboard Indicators	2-29
	GLAN LEDs.....	2-29
	Onboard Power LED	2-29
	Onboard SAS Activity LED Indicators.....	2-30
2-9	Parallel Port, Floppy, SIMLP IPMI, Hard Disk Drive and SAS Connections	2-31
	Parallel Port Connector	2-31
	Floppy Connector	2-32

SIMLP IPMI Slot.....	2-32
IDE Connectors	2-33
SAS Connectors.....	2-34

Chapter 3: Troubleshooting

3-1 Troubleshooting Procedures	3-1
Before Power On.....	3-1
No Power.....	3-1
No Video	3-1
Losing the System's Setup Configuration	3-2
Memory Errors.....	3-2
3-2 Technical Support Procedures	3-2
3-3 Frequently Asked Questions	3-3
3-4 Returning Merchandise for Service	3-4

Chapter 4: BIOS

4-1 Introduction	4-1
4-2 Running Setup	4-2
4-3 Main BIOS Setup	4-2
4-4 Advanced Setup	4-6
4-5 Security Setup	4-23
4-6 Boot Setup.....	4-24
4-7 Exit.....	4-25

Appendices:

Appendix A: BIOS POST Messages.....	A-1
Appendix B: BIOS POST Codes.....	B-1
Appendix C: Installing the Adaptec HostRAID Utility and the Windows OS	C-1
Appendix D: Intel HostRAID and the Windows OS Setup Guidelines	D-1
Appendix E: Installing Other Software Programs and Drivers	E-1

Chapter 1

Introduction

1-1 Overview

Checklist

Congratulations on purchasing your computer motherboard from an acknowledged leader in the industry. Supermicro boards are designed with the utmost attention to detail to provide you with the highest standards in quality and performance. Check that the following items have all been included with your motherboard. If anything listed here is damaged or missing, contact your retailer.

All the items are included in the retail box.

One (1) Supermicro Mainboard

One (1) ribbon cable for IDE devices (CBL-0036L-02)

One (1) floppy ribbon cable (CBL-0022L)

Four (4) SATA cables (CBL-0044L)

Two (2) I-Pass-to-4 SATA Straight Through Cables (CBL-0097L-02)

One (1) I/O backpanel shield (MCP-260-74301-0N)

One (1) Supermicro CD containing drivers and utilities

One (1) User's/BIOS Manual

Contacting Supermicro

Headquarters

Address: Super Micro Computer, Inc.
980 Rock Ave.
San Jose, CA 95131 U.S.A.

Tel: +1 (408) 503-8000

Fax: +1 (408) 503-8008

Email: marketing@supermicro.com (General Information)
support@supermicro.com (Technical Support)

Web Site: www.supermicro.com

Europe

Address: Super Micro Computer B.V.
Het Sterrenbeeld 28, 5215 ML
's-Hertogenbosch, The Netherlands

Tel: +31 (0) 73-6400390

Fax: +31 (0) 73-6416525

Email: sales@supermicro.nl (General Information)
support@supermicro.nl (Technical Support)
rma@supermicro.nl (Customer Support)

Asia-Pacific

Address: Super Micro Computer, Inc.
4F, No. 232-1, Liancheng Rd.
Chung-Ho 235, Taipei County
Taiwan, R.O.C.

Tel: +886-(2) 8226-3990

Fax: +886-(2) 8226-3991

Web Site: www.supermicro.com.tw

Technical Support:

Email: support@supermicro.com.tw

Tel: 886-2-8228-1366, ext.132 or 139

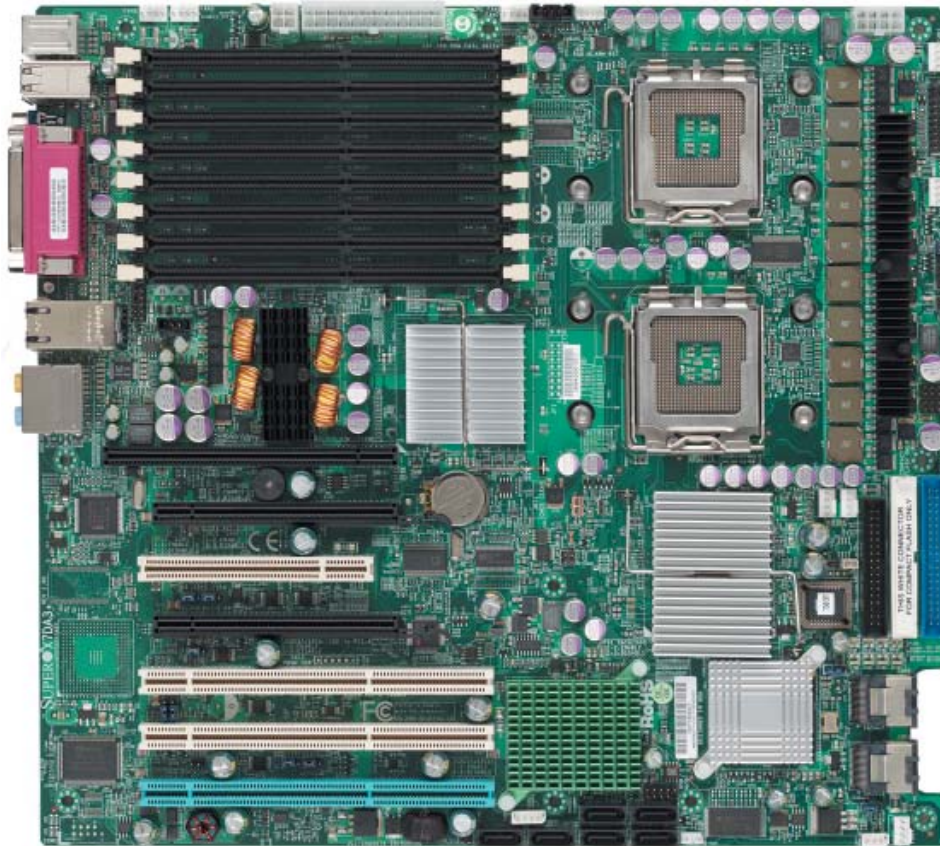
SUPER X7DA3+ Image

Note: The drawings and pictures shown in this manual were based on the latest PCB Revision available at the time of publishing of the manual. The motherboard you've received may or may not look exactly the same as the graphics shown in the manual.

SUPER X7DA3+ Motherboard Layout

(not drawn to scale)

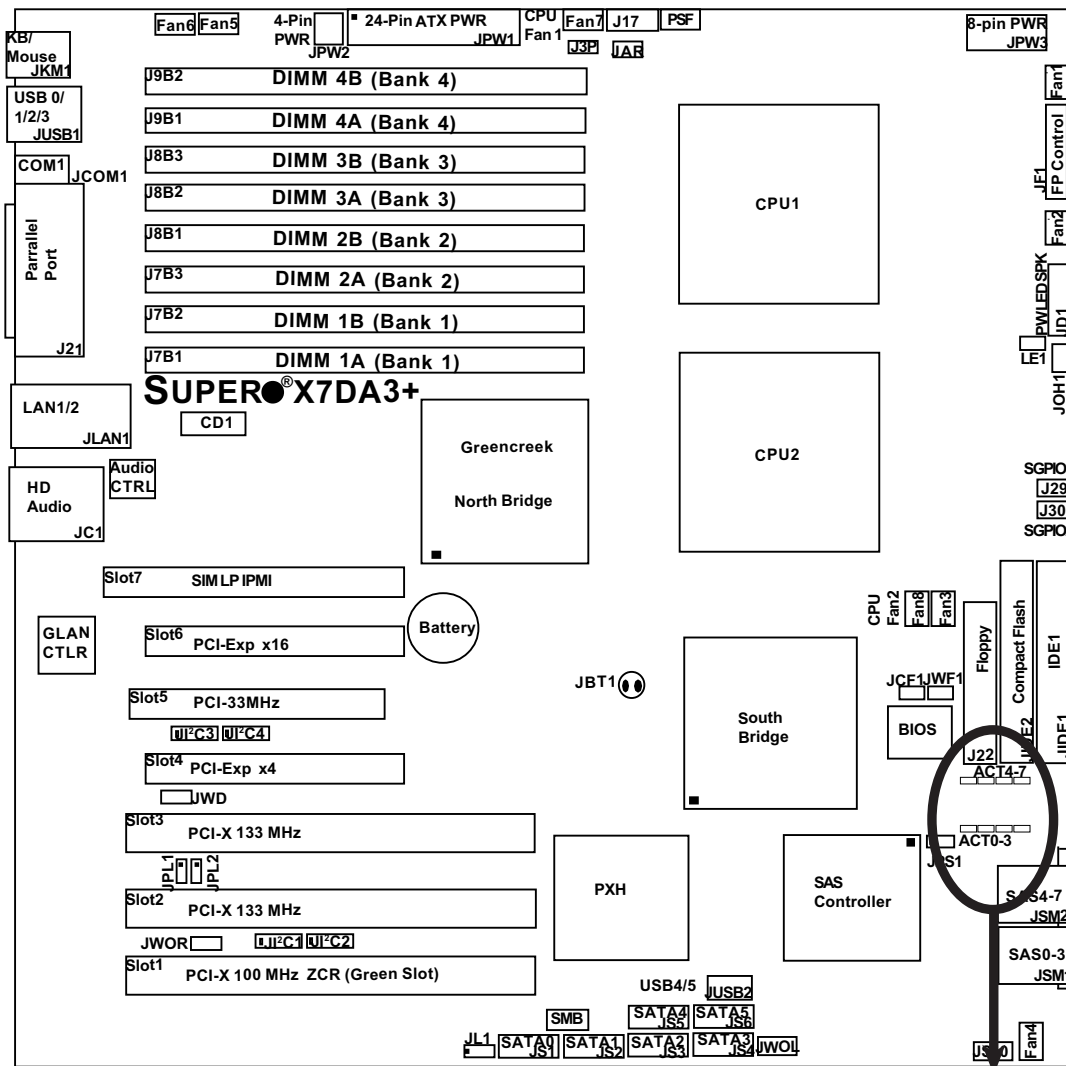

SAS ACT4-7 LEDs

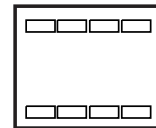

SAS ACT0-3 LEDs

Notes:

1. Jumpers not indicated are for test purposes only.
2. See Chapter 2 for detailed information on jumpers, I/O ports and JF1 front panel connections.
3. "■" indicates the location of Pin 1.
4. Please install the ZCR card on the green slot for it to work properly.
5. The drawings and pictures shown in this manual were based on the latest PCB Revision available at the time of publishing of the manual. The motherboard you've received may or may not look exactly the same as the graphics shown in the manual.

Quick Reference (X7DA3+)

Jumper	Description	Default Setting
J3P	3rd PWR Failure Detect	Off (Disabled)
JAR	Alarm Reset	Off (Disabled)
JBT1	CMOS Clear	See Chapter 2
JCF1	Compact Card Master/Slave Select	On (Master)
JI ² C1/JI ² C2	SMB to PCI-X Slots	Pins 2-3 (Disabled)
JI ² C3/JI ² C4	SMB to PCI-E Slots	Pins 2-3 (Disabled)
JPS1	SAS Controller Enable	Pins 1-2 (Enabled)
JPL1/JPL2	GLAN1/GLAN2 Enable	Pins 1-2 (Enabled)
JWD	Watch Dog	Pins 1-2 (Reset)
Connector	Description	
ATX PWR (JPW1)	Primary 24-Pin ATX PWR Connector	
Aux. PWR/CPU PWR	+12V 4-pin PWR (JWP2)/+12V 8-pin PWR(JPW3)	
HD Audio (JC1)	High Definition Audio Connector (JC1)	
Chassis Intrusion (JL1)	Chassis Intrusion Header	
COM1 (JCOM1)	COM1 Serial Port Connector	
Compact PWR (JWF1)	Compact Card PWR Connector	
DIMM#1A-DIMM#4B	Memory DDRII Fully Buffered DIMM Slots	
FAN 1-8	Fans 1-8 (Fan7: CPU Fan1, Fan8: CPU Fan2)	
Floppy (J22)	Floppy Disk Drive Connector	
FP Control (JF1)	Front Control Panel Connector	
GLAN 1/2 (JLAN1)	G-bit Ethernet Ports	
IDE1/IDE2(Note 1 Below)	IDE1 Hard Drive (JIDE1)/Compact Flash Card (JIDE2)	
LE1 LED (Note 2 Below)	5V Standby PWR LED Indicator	
OH LED (JOH1)	Overheat LED	
Parallel (J21)	Parallel (Printer) Port	
PWR LED/SPKR (JD1)	PWR LED(pins1-3)/SpeakerHeader (pins 4-7)	
PWR SMB (J17)	Power System Management (I ² C) Header	
PSF	Power Supply Failure (See Chapter 2)	
SAS#0-#3,#4-#7(JSM1/2)	SAS (Serial Attached SCSI) Connectors #0-#3, #4-#7	
SATA#0-#5(JS1-JS6)	Serial ATA Connectors #0-5	
SGPIO 1/2(J29,J30)	Serial General Purpose Input/Output Headers	
SMB (J18)	System Management Bus Header	
Slot 7	SIM Low Profile IPMI Connector	
USB 0/1/2/3 (JUSB1)	Back Panel USB 0/1/2/3(JUSB1)	
USB 4/5 (JUSB2)	Front Panel USB4/5 (JUSB2)	
WOL (JWOL)	Wake-on-LAN Header	
WOR (JWOR)	Wake-on-Ring Header	

Notes: 1.JIDE2 is for Compact Card Use only. JCF1 is used to configure the compact flash card as a master or a slave drive. Be sure to connect JWF1 to a power supply to provide power to the compact flash card. 2. When LE1 is on, the Standby Power is on. Unplug the PWR cables before changing components.

Motherboard Features

CPU

- Dual Intel® 64-bit LGA 771 Quad-Core/Dual-Core Xeon 5300/5100/5000 Series processors at a front side bus speed of 1.333 GHz/1.066 GHz/667 MHz

Memory

- Eight 240-pin DIMM sockets with support up to 32 GB ECC DDR2 FBD 667/533 Memory (See Section 2-3 in Chapter 2 for DIMM Slot Population.)

Chipset

- Intel 5000X (Greencreek) chipset, including: the 5000X (Greencreek) Memory Control Hub (MCH), the Enterprise South Bridge 2 (ESB2), and the I/O subsystem (PXH-V).

Expansion Slots

Two PCI-E slots (one x16 signal on x16 slot, one x4 signal on x16 slot)
Three 64-bit PCI-X slots (two: PCI-X-133 slots, one PCI-X-100 ZCR Slot)
One PCI-33 MHz slot
One Low Profile IPMI slot

BIOS

- 8 Mb Phoenix® Flash ROM
- DMI 2.1, PCI 2.2, ACPI 1.0, Plug and Play (PnP), SMBIOS 2.3, PCI-X 1.0

PC Health Monitoring

- Onboard voltage monitors for CPU cores, chipset voltage, 1.8V, 3.3V, +5V, +12V, -12V, 3.3V standby and 5V standby
- Fan status monitor with firmware speed control
- CPU/chassis temperature monitors
- Platform Environment Control Interface (PECI)
- CPU slow-down on temperature overheat
- CPU thermal trip support for processor protection
- Power-up mode control for recovery from AC power loss
- Auto-switching voltage regulator for CPU core
- System overheat LED and control
- Chassis intrusion detection
- System resource alert

ACPI Features

- Slow blinking LED for suspend state indicator
- Main switch override mechanism

Onboard I/O

- Adaptec AIC-9410W SAS Controller w/HostRAID support (RAID 0, 1,10)
- Intel ESB-2 South Bridge supports 6 SATA connectors (w/RAID 0, 1, 5,10) (For the Windows OS only)
- One SIM Low Profile IPMI slot
- Intel 82563EB Gigabit Dual-Port Ethernet controller
- 1 EIDE Ultra DMA/100 bus master interfaces w/2 devices supported
- 1 floppy port interface
- 1 serial port
- 1 EPP/ECP Parallel Port
- 7.1+2 Channel High Definition Audio Connection
- Super I/O: Winbond W83627HG w/Hardware Monitor support: W83793G
- PS/2 mouse and PS/2 keyboard ports
- Up to 6 USB 2.0 (Universal Serial Bus) (4 ports, 2 Headers)
- Super I/O

Other

- External modem ring-on
- Wake-on-LAN (WOL)
- Wake-on-Ring (WOR)
- Console redirection
- Onboard Fan Speed Control by Thermal Management via BIOS

CD/Diskette Utilities

- BIOS flash upgrade utility and device drivers

Dimensions

- Ext. ATX 12.08" x 13.05" (306.8 mmx 331.5 mm)

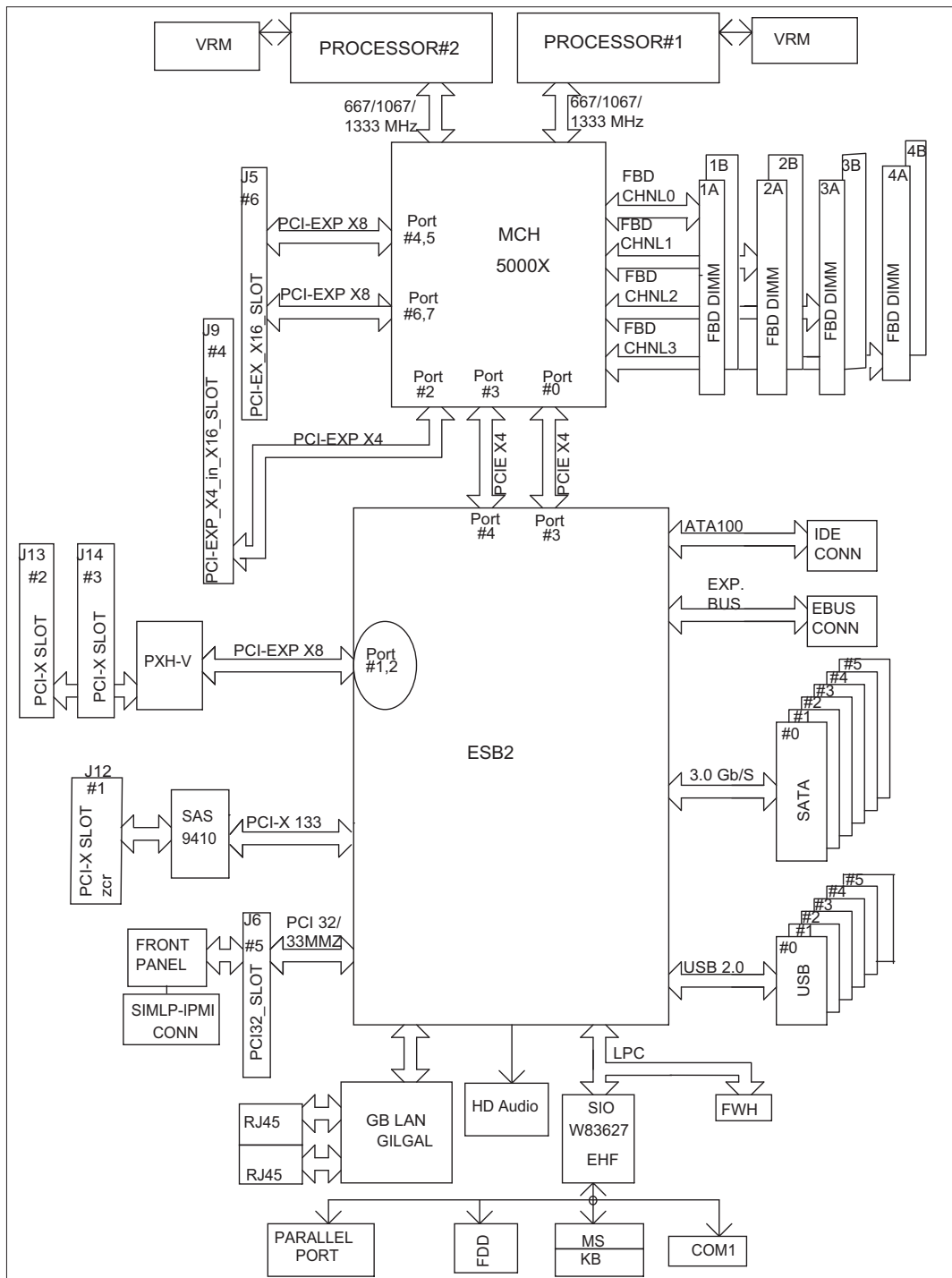

Block Diagram of the 5000X (Greencreek) Chipset

Note: This is a general block diagram. Please see the previous Motherboard Features pages for details on the features of each motherboard.

1-2 Chipset Overview

Built upon the functionality and the capability of the 5000X (Greencreek) chipset, the X7DA3+ motherboard provides the performance and feature set required for dual processor-based workstations with configuration options optimized for communications, presentation, storage, computation or database applications. The 5000X (Greencreek) chipset supports single or dual Xeon 64-bit dual core processor with front side bus speeds of up to 1.333 GHz. The chipset consists of the 5000X (Greencreek) Memory Controller Hub (MCH), the Enterprise South Bridge 2 (ESB2), and the I/O subsystem (PXH-V).

The 5000X (Greencreek) MCH chipset is designed for symmetric multiprocessing across two independent front side bus interfaces. Each front side bus uses a 64-bit wide, 1.333 GHz data bus that transfers data at 10.7 GB/sec. The MCH chipset connects up to 8 Fully Buffered DIMM modules, providing a total of 32.0 GB/s for DDR2 667/533 memory. The MCH chipset also provides one x8 PCI-Express and one x4 ESI interface to the ESB2. In addition, the 5000X (Greencreek) chipset offers a wide range of RAS features, including memory interface ECC, x4/x8 Single Device Data Correction, CRC, parity protection, memory mirroring and memory sparing.

Xeon Dual Core Processor Features

Designed to be used with conjunction of the 5000X (Greencreek) chipset, the Xeon Dual Core Processors provide a feature set as follows:

The Xeon Dual Core Processors

L1 Cache Size: Instruction Cache (32KB/16KB), Data Cache (32KB/24KB)

L2 Cache Size: 2MB (per core)

Data Bus Transfer Rate: 8.5 GB/s

Package: FC-LGA6/FC-LGA4, 771 Lands

1-3 Special Features

Recovery from AC Power Loss

BIOS provides a setting for you to determine how the system will respond when AC power is lost and then restored to the system. You can choose for the system to remain powered off (in which case you must hit the power switch to turn it back on) or for it to automatically return to a power-on state. See the Power Lost Control setting in the Advanced BIOS Setup section (Boot Features) to change this setting. The default setting is **Last State**.

1-4 PC Health Monitoring

This section describes the PC health monitoring features of the X7DA3+. All have an onboard System Hardware Monitor chip that supports PC health monitoring.

Onboard Voltage Monitoring

An onboard voltage monitor will scan these voltages continuously: CPU Cores, Chipset Voltage, +3.3V, +5V, +12V, -12V, +3.3V Standby, +5V Standby and Vbat. Once a voltage becomes unstable, a warning is given or an error message is sent to the screen. Users can adjust the voltage thresholds to define the sensitivity of the voltage monitor.

Fan Status Monitor with Firmware Control

The PC health monitor can check the RPM status of the cooling fans. The onboard CPU and chassis fans are controlled by Thermal Management via BIOS (under Hardware Monitoring in the Advanced Setting).

Environmental Temperature Control

The thermal control sensor monitors the CPU temperature in real time and will turn on the thermal control fan whenever the CPU temperature exceeds a user-defined threshold. The overheat circuitry runs independently from the CPU. Once it detects that the CPU temperature is too high, it will automatically turn on the thermal fan control to prevent any overheat damage to the CPU. The onboard chassis thermal circuitry can monitor the overall system temperature and alert users when the chassis temperature is too high.

CPU Fan Auto-Off in Sleep Mode

The CPU fan activates when the power is turned on. It continues to operate when the system enters Standby mode. When in sleep mode, the CPU will not run at full power, thereby generating less heat.

CPU Overheat LED and Control

This feature is available when the user enables the CPU overheat warning function in the BIOS. This allows the user to define an overheat temperature. When this temperature is exceeded, both the overheat fan and the warning LED are triggered.

System Resource Alert

This feature is available when used with Supero Doctor III in the Windows OS environment or used with Supero Doctor II in Linux. Supero Doctor is used to notify the user of certain system events. For example, if the system is running low on virtual memory and there is insufficient hard drive space for saving the data, you can be alerted of the potential problem. You can also configure Supero Doctor to provide you with warnings when the system temperature goes beyond a pre-defined range.

1-5 ACPI Features

ACPI stands for Advanced Configuration and Power Interface. The ACPI specification defines a flexible and abstract hardware interface that provides a standard way to integrate power management features throughout a PC system, including its hardware, operating system and application software. This enables the system to automatically turn on and off peripherals such as CD-ROMs, network cards, hard disk drives and printers. This also includes consumer devices connected to the PC such as VCRs, TVs, telephones and stereos.

In addition to enabling operating system-directed power management, ACPI provides a generic system event mechanism for Plug and Play and an operating system-independent interface for configuration control. ACPI leverages the Plug and Play BIOS data structures while providing a processor architecture-independent implementation that is compatible with Windows 2000, Windows XP and Windows 2003 Server.

Slow Blinking LED for Suspend-State Indicator

When the CPU goes into a suspend state, the chassis power LED will start blinking to indicate that the CPU is in suspend mode. When the user presses any key, the CPU will wake-up and the LED will automatically stop blinking and remain on.

Main Switch Override Mechanism

When an ATX power supply is used, the power button can function as a system suspend button to make the system enter a SoftOff state. The monitor will be suspended and the hard drive will spin down. Pressing the power button again will cause the whole system to wake-up. During the SoftOff state, the ATX power

supply provides power to keep the required circuitry in the system alive. In case the system malfunctions and you want to turn off the power, just press and hold the power button for 4 seconds. This option can be set in the Power section of the BIOS Setup routine.

External Wake-On-LAN

Wake-On-LAN is defined as the ability of a management application to remotely power up a computer that is powered off. Remote PC setup, up-dates and asset tracking can occur after hours and on weekends so that daily LAN traffic is kept to a minimum and users are not interrupted. The motherboard has a 3-pin header (WOL) to connect to the 3-pin header on a Network Interface Card (NIC) that has WOL capability. In addition, an onboard LAN controller can also support WOL without any connection to the WOL header. The 3-pin WOL header is to be used with a LAN add-on card only.

Note: Wake-On-LAN requires an ATX 2.01 (or above) compliant power supply.

1-6 Power Supply

As with all computer products, a stable power source is necessary for proper and reliable operation. It is even more important for processors that have high CPU clock rates.

The X7DA3+ can only accommodate 24-pin ATX power supply. Although most power supplies generally meet the specifications required by the motherboard, some are inadequate. You should use one that will supply at least 400W of power. In addition, the 12V 8-pin and the 4-pin are also required for adequate power supply to the system. Also your power supply must supply 1.5A for the Ethernet ports.

It is strongly recommended that you use a high quality power supply that meets ATX power supply Specification 2.01 or above. It must also be SSI compliant (For more information, please refer to the website at <http://www.ssiforum.org/>). Additionally, in areas where noisy power transmission is present, you may choose to install a line filter to shield the computer from noise. It is recommended that you also install a power surge protector to help avoid problems caused by power surges.

1-7 Super I/O

The disk drive adapter functions of the Super I/O chip include a floppy disk drive controller that is compatible with industry standard 82077/765, a data separator, write pre-compensation circuitry, decode logic, data rate selection, a clock generator, drive interface control logic and interrupt and DMA logic. The wide range of

functions integrated onto the Super I/O greatly reduces the number of components required for interfacing with floppy disk drives. The Super I/O supports 360 K, 720 K, 1.2 M, 1.44 M or 2.88 M disk drives and data transfer rates of 250 Kb/s, 500 Kb/s or 1 Mb/s. It also provides two high-speed, 16550 compatible serial communication ports (UARTs). Each UART includes a 16-byte send/receive FIFO, a programmable baud rate generator, complete modem control capability and a processor interrupt system. Both UARTs provide legacy speed with baud rate of up to 115.2 Kbps as well as an advanced speed with baud rates of 250 K, 500 K, or 1 Mb/s, which support higher speed modems.

The Super I/O supports one PC-compatible printer port (SPP), Bi-directional Printer Port (BPP) , Enhanced Parallel Port (EPP) or Extended Capabilities Port (ECP).

The Super I/O provides functions that comply with ACPI (Advanced Configuration and Power Interface), which includes support of legacy and ACPI power management through an SMI or SCI function pin. It also features auto power management to reduce power consumption.

Notes

Chapter 2

Installation

2-1 Static-Sensitive Devices

Electro-Static-Discharge (ESD) can damage electronic components. To prevent damage to your system board, it is important to handle it very carefully. The following measures are generally sufficient to protect your equipment from ESD.

Precautions

- Use a grounded wrist strap designed to prevent static discharge.
- Touch a grounded metal object before removing the board from the antistatic bag.
- Handle the board by its edges only; do not touch its components, peripheral chips, memory modules or gold contacts.
- When handling chips or modules, avoid touching their pins.
- Put the motherboard and peripherals back into their antistatic bags when not in use.
- For grounding purposes, make sure your computer chassis provides excellent conductivity between the power supply, the case, the mounting fasteners and the motherboard.

Unpacking

The motherboard is shipped in antistatic packaging to avoid static damage. When unpacking the board, make sure the person handling it is static protected.

2-2 Motherboard Installation

(Note: Be sure to mount the motherboard into the chassis before you install the CPU onto the motherboard.)

All motherboards have standard mounting holes to fit different types of chassis. Make sure that the locations of all the mounting holes for both motherboard and chassis match. Make sure that the metal standoffs click in or are screwed in tightly. Then, use a screwdriver to secure the motherboard onto the motherboard tray. **(Note: some components are very close to the mounting holes. Please take precautionary measures to prevent damage done to these components when you install the motherboard into the chassis.)**

2-3 Processor and Heatsink Installation



When handling the processor package, avoid placing direct pressure on the label area of the fan.

- Notes:**
1. Always connect the power cord last and always remove it before adding, removing or changing any hardware components. Make sure that you install the processor into the CPU socket before you install the CPU heatsink.
 2. Intel's boxed Xeon CPU package contains the CPU fan and heatsink assembly. If you buy a CPU separately, make sure that you use only Intel-certified multi-directional heatsink and fan.
 3. The Intel Xeon LGA 771 heatsink and fan comes with a push-pin design and no tool is needed for installation.
 4. Make sure to install the motherboard into the chassis before you install the CPU heatsink and fan.
 5. When purchasing an LGA 771 CPU or when receiving a motherboard with an LGA 771 CPU pre-installed, make sure that the CPU plastic cap is in place and none of the CPU pins are bent; otherwise, contact the retailer immediately.
 6. Refer to the MB Features Section for more details on CPU support.

Installing the LGA771 Processor

1. Press the load lever to release the load plate, which covers the CPU socket, from its locking position.

2. Gently lift the load lever to open the load plate.

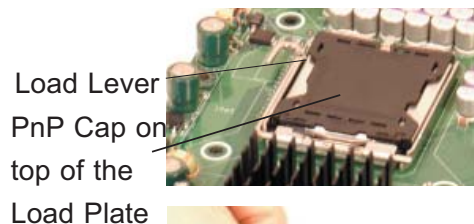

Load Plate (with PnP Cap attached)

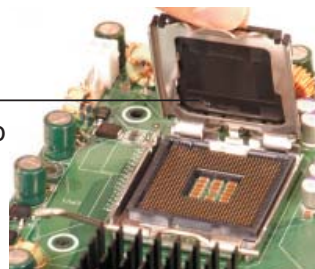

3. Use your thumb and your index finger to hold the CPU at the North Center Edge and the South Center Edge of the CPU.

4. Align CPU Pin1 (the CPU corner marked with a triangle) against the socket corner that is marked with a triangle cutout.

5. Align the CPU key that is the semi-circle cutout below a gold dot against the socket key, the Notch on the same side of the triangle cutout on the socket.

6. Once aligned, carefully lower the CPU straight down to the socket. (Do not drop the CPU on the socket. Do not move the CPU horizontally or vertically. Do not rub the CPU against the surface or against any pins of the socket to avoid damage to the CPU or the socket.)

7. With the CPU inside the socket, inspect the four corners of the CPU to make sure that the CPU is properly installed.

8. Use your thumb to gently push the load lever down to the lever lock.

9. If the CPU is properly installed into the socket, the plastic PnP cap will be automatically released from the load plate when the load lever is pushed in the lever lock. Remove the PnP cap from the motherboard.

 **(Warning:** Please save the plastic PnP cap. The motherboard must be shipped with the PnP cap properly installed to protect the CPU socket pins. Shipment without the PnP cap properly installed will cause damage to the socket pins.)

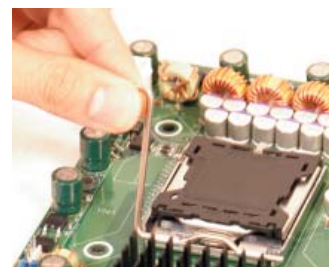
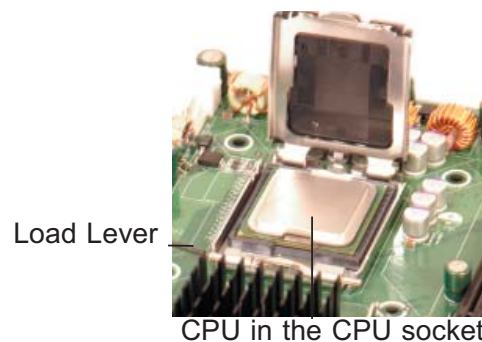
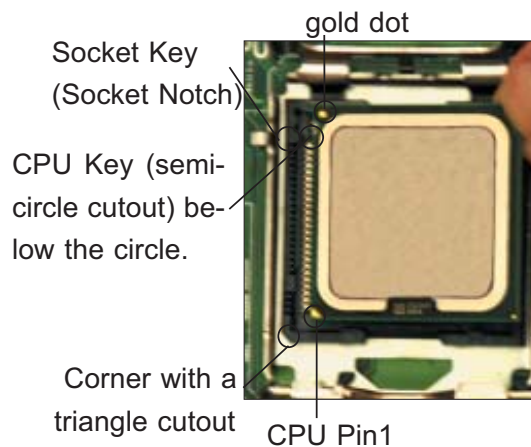

Plastic cap is released from the load plate if CPU properly installed.



Installing the Heatsink

CEK Heatsink Installation

1. Do not apply any thermal grease to the heatsink or the CPU die-the required amount has already been applied.

2. Place the heatsink on top of the CPU so that the four mounting holes are aligned with those on the retention mechanism.

3. Screw in two diagonal screws (ie the #1 and the #2 screws) until just snug (-do not fully tighten the screws to avoid possible damage to the CPU.)

4. Finish the installation by fully tightening all four screws.

CEK Passive Heatsink

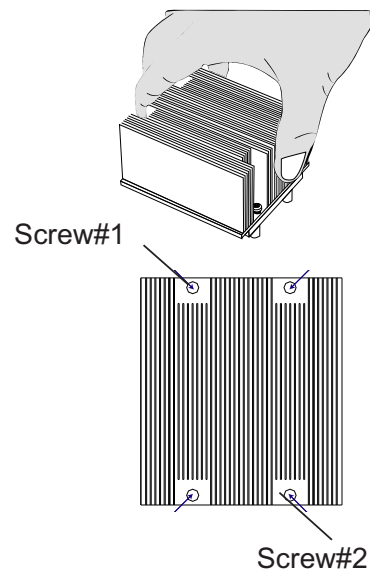
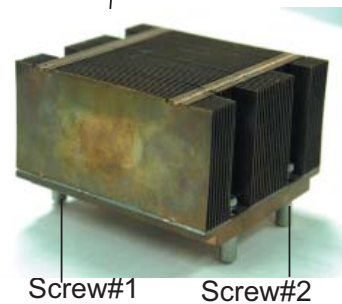

Uninstalling the Heatsink



(Warning: We do not recommend that the CPU or the heatsink be removed. However, if you do need to remove the heatsink, please follow the instructions below to uninstall the heatsink to prevent damage done to the CPU or the CPU socket.)

1. Unscrew and remove the heatsink screws from the motherboard in the sequence as shown in the picture on the right.

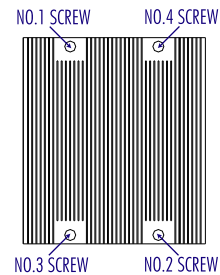

2. Hold the heatsink as shown in the picture on the right and gently wriggle the heatsink to loosen it from the CPU. (Do not use excessive force when wriggling the heatsink!!)

3. Once the CPU is loosened, remove the heatsink from the CPU socket.

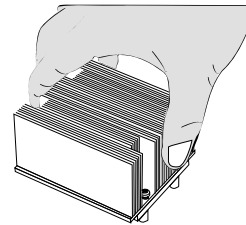

4. Clean the surface of the CPU and the heatsink to get rid of the old thermal grease. Reapply the proper amount of thermal grease on the surface before you re-install the CPU and the heatsink.

2-4 Installing DIMMs

Note: Check the Supermicro web site for recommended memory modules.

CAUTION



Exercise extreme care when installing or removing DIMM modules to prevent any possible damage. Also note that the memory is interleaved to improve performance (see step 1).

DIMM Installation (See Figure 2-2)

1. Insert the desired number of DIMMs into the memory slots, starting with Bank 1. (For optimal memory performance, please install four modules at a time. Please refer to the table below.)
2. Insert each DIMM module vertically into its slot. Pay attention to the notch along the bottom of the module to prevent inserting the DIMM module incorrectly.
3. Gently press down on the DIMM module until it snaps into place in the slot. Repeat for all modules (see step 1 above).

Memory Support

The X7DA3+ supports up to 32 GB fully buffered (FBD) ECC DDR2 533/667 in 8 DIMMs. Populating DIMM modules with a pair (or pairs) of memory modules that are of the same size and of the same type in Bank1, Bank2, Bank3 and Bank4 will result in interleaving memory.

Note 1: Due to the OS limitations, some operating systems may not show more than 4 GB of memory.

Optimized DIMM Population Configurations								
Number of DIMMs	Branch0				Branch1			
	Bank 1 (Channel 0)		Bank 2 (Channel 1)		Bank 3 (Channel 2)		Bank 4 (Channel 3)	
2 DIMMs	1A	----	2A	----	----	----	----	----
4 DIMMs	1A	----	2A	----	3A	----	4A	----
6 DIMMs	1A	1B	2A	2B	3A	----	4A	----
8 DIMMs	1A	1B	2A	2B	3A	3B	4A	4B

(*Notes: i. DIMM slot# specified: DIMM slot to be populated; “---”: DIMM slot not to be populated. ii. Both FBD 533 MHz and 667MHz DIMMs are supported; however, you need to use the memory modules of the same speed and of the same type on a motherboard. iii. Interleaved memory is supported when pairs of DIMM modules are installed. To optimize memory performance, please install pairs of DIMMs in **both Branch 0 and Branch 1**. iv. For memory to work properly, you need to follow the restrictions listed above.)

Note 2: Due to memory allocation to system devices, memory remaining available for operational use will be reduced when 4 GB of RAM is used. The reduction in memory availability is disproportional. (Refer to the following Memory Availability Table for details.)

Possible System Memory Allocation & Availability		
System Device	Size	Physical Memory Remaining (-Available) (4 GB Total System Memory)
Firmware Hub flash memory (System BIOS)	1 MB	3.99
Local APIC	4 KB	3.99
Area Reserved for the chipset	2 MB	3.99
I/O APIC (4 Kbytes)	4 KB	3.99
PCI Enumeration Area 1	256 MB	3.76
PCI Express (256 MB)	256 MB	3.51
PCI Enumeration Area 2 (if needed) -Aligned on 256-MB boundary-	512 MB	3.01
VGA Memory	16 MB	2.85
TSEG	1 MB	2.84
Memory available to OS and other applications		2.84

Installing and Removing DIMMs

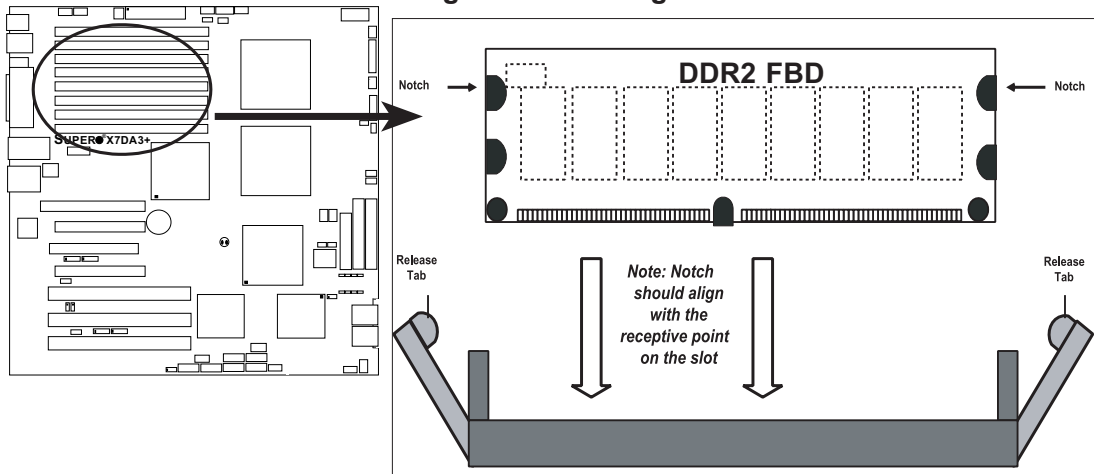

To Install: Insert module vertically and press down until it snaps into place. Pay attention to the alignment notch at the bottom.

To Remove:
Use your thumbs to gently push the release tabs near both ends of the module. This should release it from the slot.

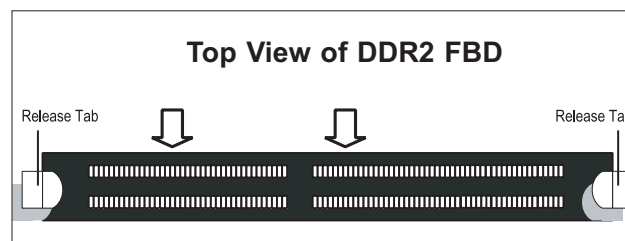

2-5 Control Panel Connectors/IO Ports

The I/O ports are color coded in conformance with the PC 99 specification. See Figure 2-3 below for the colors and locations of the various I/O ports.

Back Panel Connectors/IO Ports

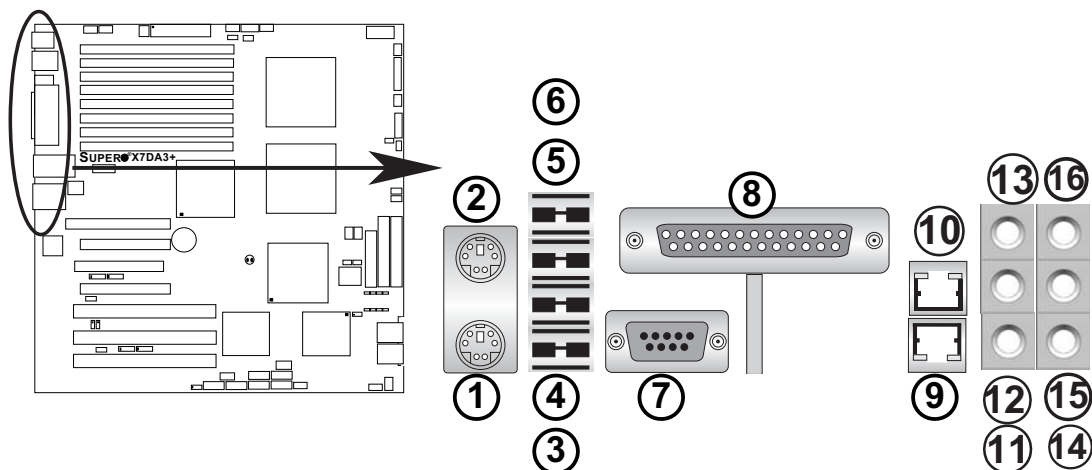

Back Panel I/O Port Locations and Definitions

Back Panel Connectors

1. Keyboard (Purple)
2. PS/2 Mouse (Green)
3. Back Panel USB Port 0
4. Back Panel USB Port 1
5. Back Panel USB Port 2
6. Back Panel USB Port 3
7. COM Port 1 (Turquoise)
8. Parallel Port (Printer)
9. Gigabit LAN 2
10. Gigabit LAN 1
11. Side_Surround (Grey)
12. Back_Surround (Black)
13. CEN/LFE (Orange)
14. Microphone-In (Pink)
15. Front (Green)
16. Line-In (Blue)

(See Section 2-5 for details.)

Front Control Panel

JF1 contains header pins for various buttons and indicators that are normally located on a control panel at the front of the chassis. These connectors are designed specifically for use with Supermicro server chassis. See Figure 2-4 for the descriptions of the various control panel buttons and LED indicators. Refer to the following section for descriptions and pin definitions.

JF1 Header Pins

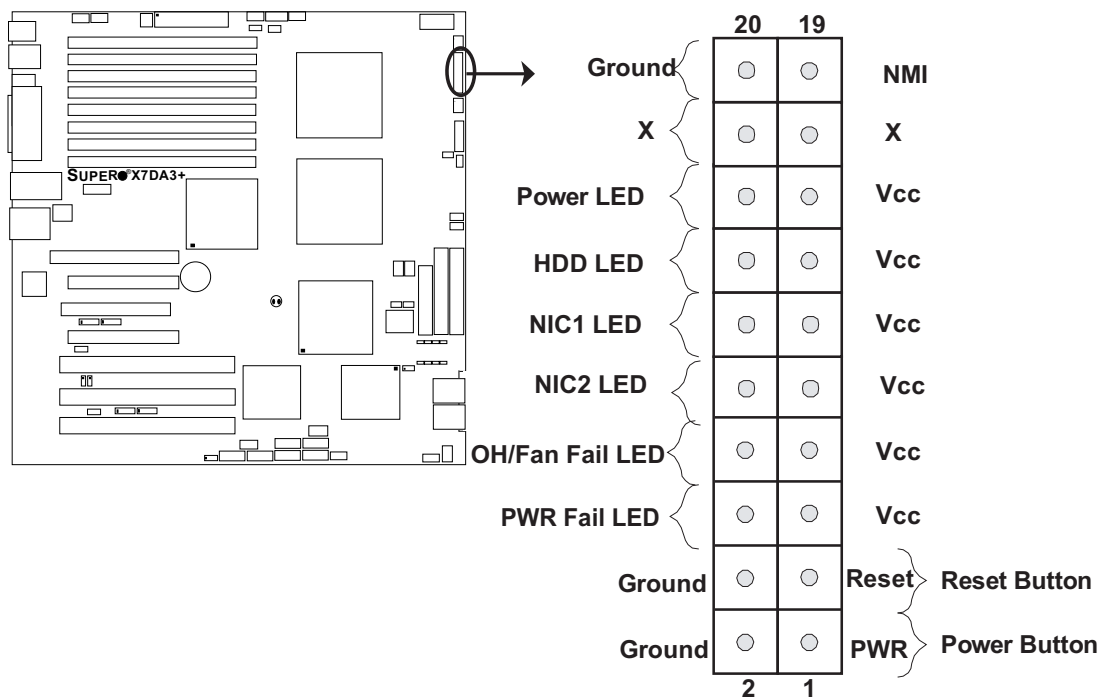

Front Control Panel Pin Definitions

NMI Button

The non-maskable interrupt button header is located on pins 19 and 20 of JF1. Refer to the table on the right for pin definitions.

NMI Button Pin Definitions (JF1)	
Pin#	Definition
19	Control
20	Ground

Power LED

The Power LED connection is located on pins 15 and 16 of JF1. Refer to the table on the right for pin definitions.

Power LED Pin Definitions (JF1)	
Pin#	Definition
15	+5V
16	Ground

A. NMI

B. PWR LED

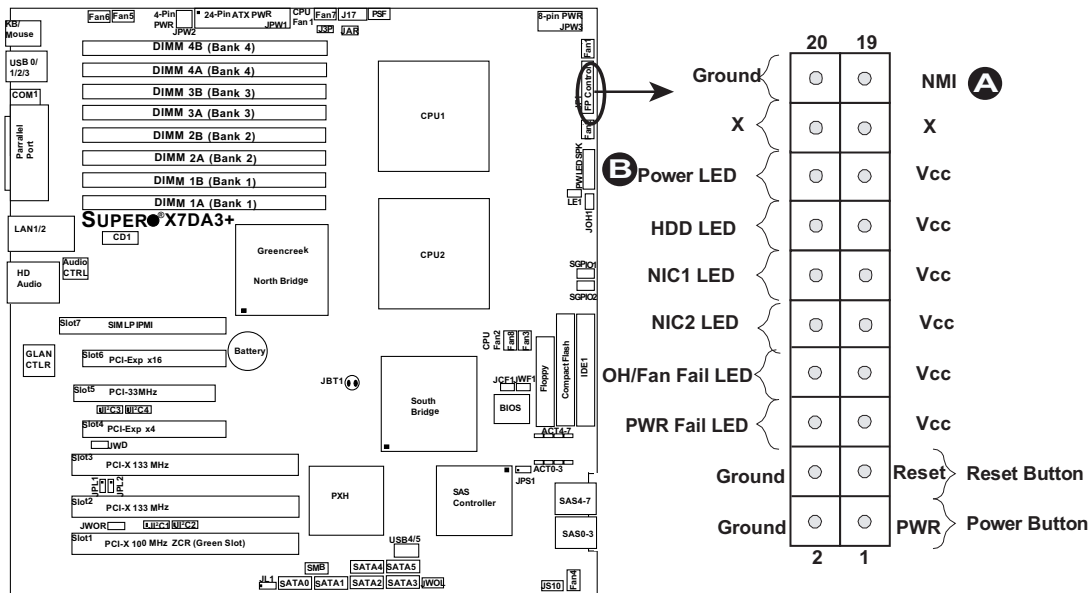

HDD LED

The HDD LED connection is located on pins 13 and 14 of JF1. Attach the hard drive LED cable here to display disk activity (for any hard drives on the system, including SAS, Serial ATA and IDE). See the table on the right for pin definitions.

HDD LED Pin Definitions (JF1)	
Pin#	Definition
13	+5V
14	HD Active

NIC1/NIC2 LED Indicators

The NIC (Network Interface Controller) LED connection for GLAN port1 is located on pins 11 and 12 of JF1 and the LED connection for GLAN Port2 is on Pins 9 and 10. Attach the NIC LED cables to display network activity. Refer to the table on the right for pin definitions.

GLAN1/2 LED Pin Definitions (JF1)	
Pin#	Definition
9/11	Vcc
10/12	Ground

A. HDD LED

B. NIC1 LED

C. NIC2 LED

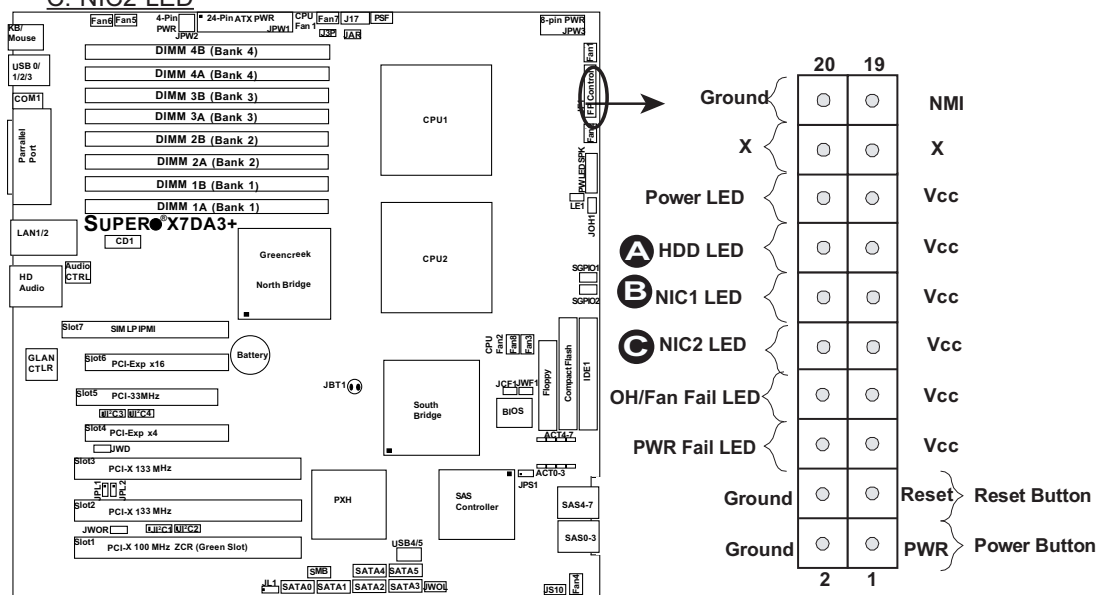

Overheat/Fan Fail LED (OH)

Connect an LED to the OH/Fan Fail connection on pins 7 and 8 of JF1 to provide advanced warning of chassis overheating or fan failure. Refer to the table on the right for pin definitions.

OH/Fan Fail LED Pin Definitions (JF1)	
Pin#	Definition
7	Vcc
8	Ground

OH/Fan Fail Indicator Status	
State	Definition
Off	Normal
On	Overheat
Flashing	Fan Fail

Power Fail LED

The Power Fail LED connection is located on pins 5 and 6 of JF1. Refer to the table on the right for pin definitions.

PWR Fail LED Pin Definitions (JF1)	
Pin#	Definition
5	Vcc
6	Ground

A. OH/Fan Fail LED

B. PWR Supply Fail

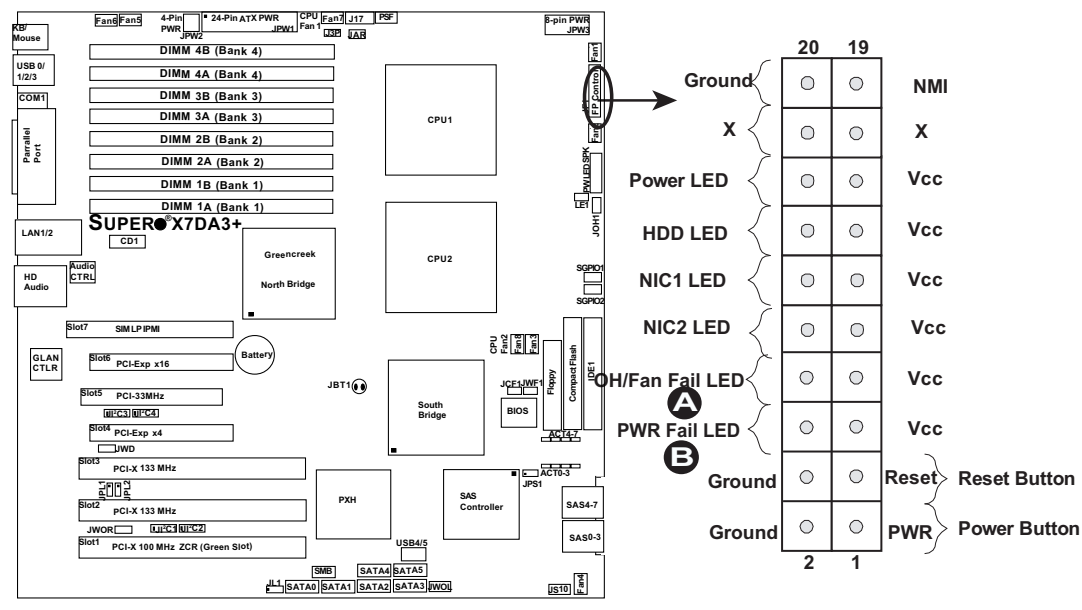

Reset Button

The Reset Button connection is located on pins 3 and 4 of JF1. Attach it to the hardware reset switch on the computer case. Refer to the table on the right for pin definitions.

Reset Button Pin Definitions (JF1)	
Pin#	Definition
3	Reset
4	Ground

Power Button

The Power Button connection is located on pins 1 and 2 of JF1. Momentarily contacting both pins will power on/off the system. This button can also be configured to function as a suspend button (with a setting in BIOS - see Chapter 4). To turn off the power when set to suspend mode, press the button for at least 4 seconds. Refer to the table on the right for pin definitions.

Power Button Pin Definitions (JF1)	
Pin#	Definition
1	Signal
2	+3V Standby

A. Reset Button

B. PWR Button

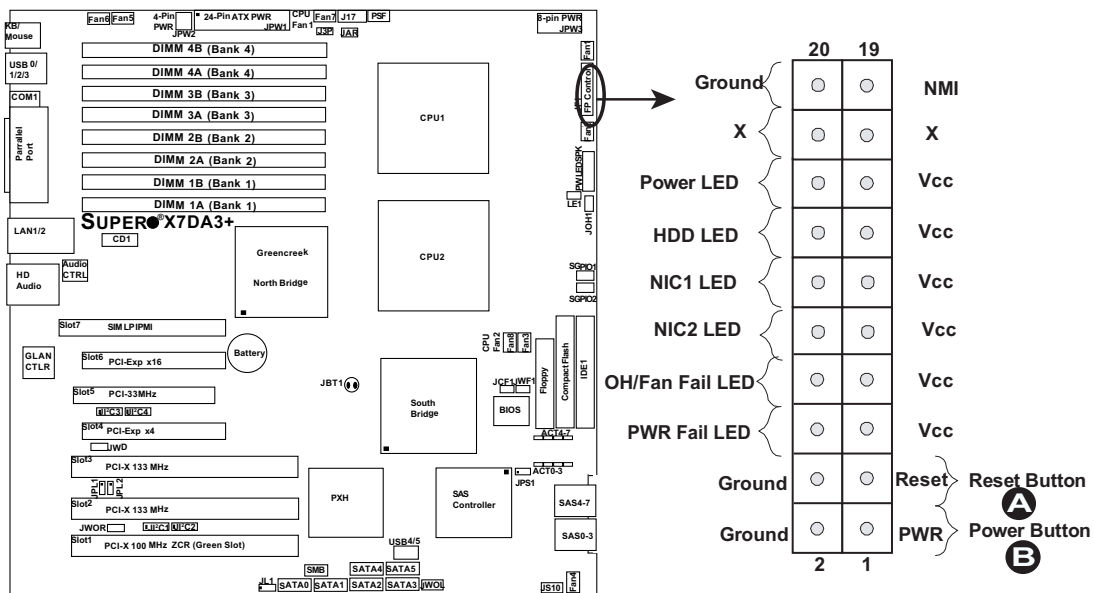

2-6 Connectors and Headers

ATX Power Connector

There are a 24-pin main power supply connector(JPW1) and an 8-pin CPU PWR connector (JPW3) on the motherboard. These power connectors meet the SSI EPS 12V specification. The 4-pin 12V PWR supply located at JPW2 is also required to provide adequate power to the system. See the table on the right for pin definitions. For the 8-pin PWR (JPW3), please refer to the item listed below.

Pin#	Definition	Pin #	Definition
13	+3.3V	1	+3.3V
14	-12V	2	+3.3V
15	COM	3	COM
16	PS_ON	4	+5V
17	COM	5	COM
18	COM	6	+5V
19	COM	7	COM
20	Res (NC)	8	PWR_OK
21	+5V	9	5VSB
22	+5V	10	+12V
23	+5V	11	+12V
24	COM	12	+3.3V

Required Connection

Processor Power Connector

In addition to the Primary ATX power connector (above), the 12V 8-pin CPU PWR connector at JPW3 must also be connected to your power supply. See the table on the right for pin definitions.

12V 4-pin Power Connector Pin Definitions		12V 8-pin Power Connector Pin Definitions	
Pins	Definition	Pins	Definition
1 and 2	Ground	1 through 4	Ground
3 and 4	+12V	5 through 8	+12V

Required Connection

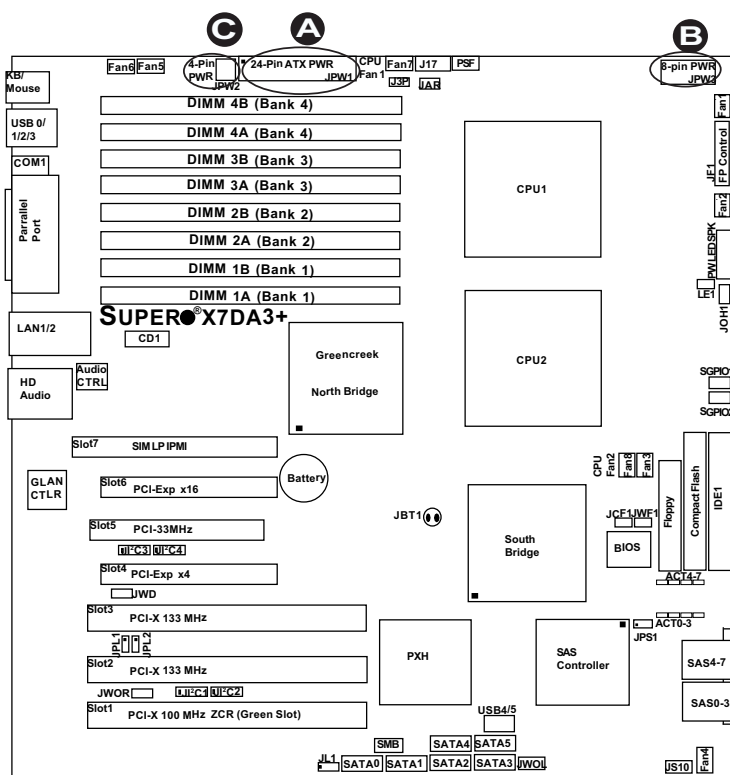

- A. 24-pin ATX PWR
- B. 8-pin Processor PWR
- C. 4-pin PWR

Universal Serial Bus (USB)

There are six USB 2.0 (Universal Serial Bus) ports/headers on the motherboard. Four of them are Back Panel USB ports (USB#0/1/2/3: JUSB1), and the other two are Front Panel USB headers (USB#4/5:JUSB2). See the tables on the right for pin definitions.

Back Panel USB (USB0/1/2/3)	
Pin#	Definitions
1	+5V
2	PO-
3	PO+
4	Ground
5	N/A

Front Panel USB Pin Definitions (USB4)			
USB4		USB5	
Pin #	Definition	Pin #	Definition
1	+5V	1	+5V
2	PO-	2	PO-
3	PO+	3	PO+
4	Ground	4	Ground
5	Key	5	No connection

Chassis Intrusion

A Chassis Intrusion header is located at JL1 on the motherboard. Attach the appropriate cable from the chassis to inform you of a chassis intrusion when the chassis is opened.

Chassis Intrusion Pin Definitions (JL1)	
Pin#	Definition
1	Intrusion Input
2	Ground

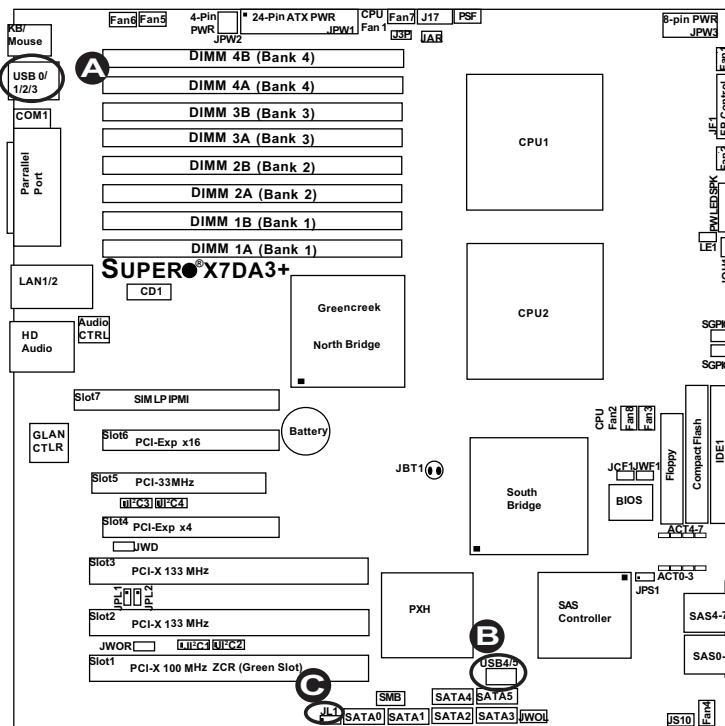

- A. Back panel USB Ports 01/2/3
- B. Front Panel USB 4/5
- C. Chassis Intrusion

Fan Headers

The X7DA3+ has eight chassis/system fan headers (Fan1 to Fan8), including two CPU Fans (Fans 7/8). (**Note:** Pins 1-3 of 4-pin fan headers are backward compatible with the traditional 3-pin fans). See the table on the right for pin definitions. (The onboard fan speeds are controlled by Thermal Management via BIOS Hardware Monitor in the Advanced Setting. **Note:** The Manufacturer Default is set to Disabled to allow the fans to constantly run at the full speed. When using Thermal Management setting, please use all 3-pin fans or all 4-pin fans on the motherboard.)

Fan Header Pin Definitions (Fan1-8)	
Pin#	Definition
1	Ground
2	+12V
3	Tachometer
4	Pulse Width Modulation

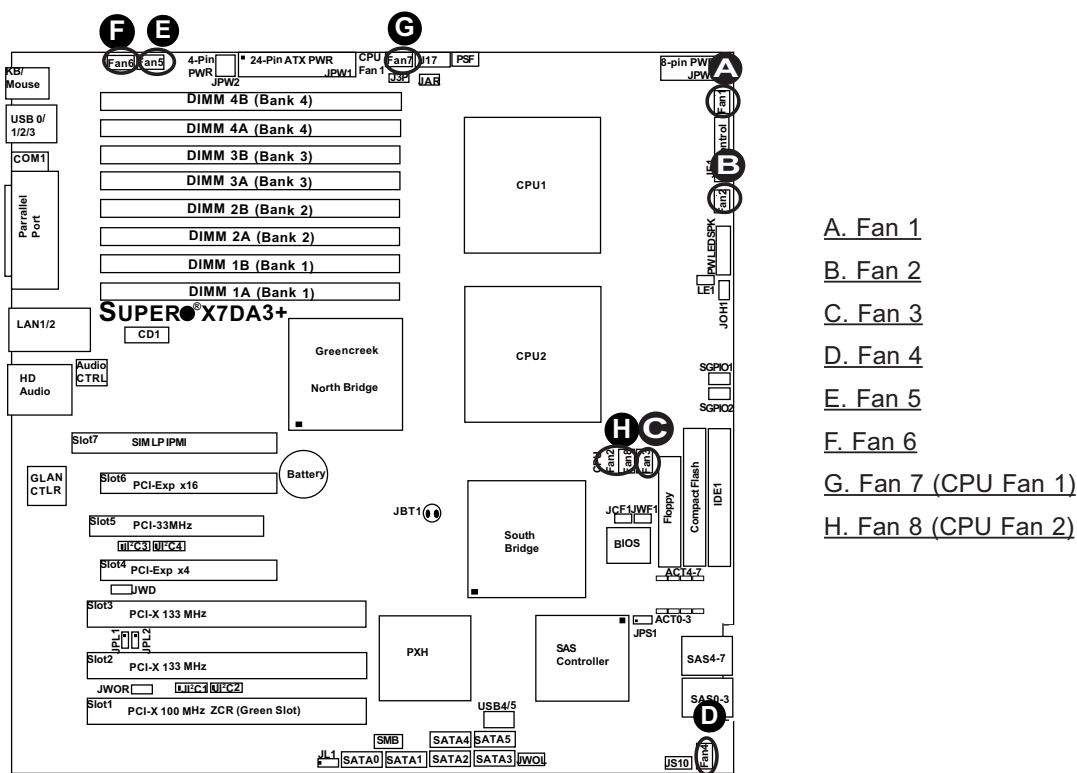

- A. Fan 1
- B. Fan 2
- C. Fan 3
- D. Fan 4
- E. Fan 5
- F. Fan 6
- G. Fan 7 (CPU Fan 1)
- H. Fan 8 (CPU Fan 2)

ATX PS/2 Keyboard and PS/2 Mouse Ports

The ATX PS/2 keyboard and the PS/2 mouse are located at JKM1. See the table on the right for pin definitions. (The mouse port is above the keyboard port. See the table on the right for pin definitions.)

PS/2 Keyboard and Mouse Port Pin Definitions	
Pin#	Definition
1	Data
2	NC
3	Ground
4	VCC
5	Clock
6	NC

Serial Port

COM1 is a connector located at JCOM1 on the IO Backpanel. See the table on the right for pin definitions.

Serial Port Pin Definitions (COM1)			
Pin #	Definition	Pin #	Definition
1	CD	6	DSR
2	RD	7	RTS
3	TD	8	CTS
4	DTR	9	RI
5	Ground	10	NC

(NC: No Connection.)

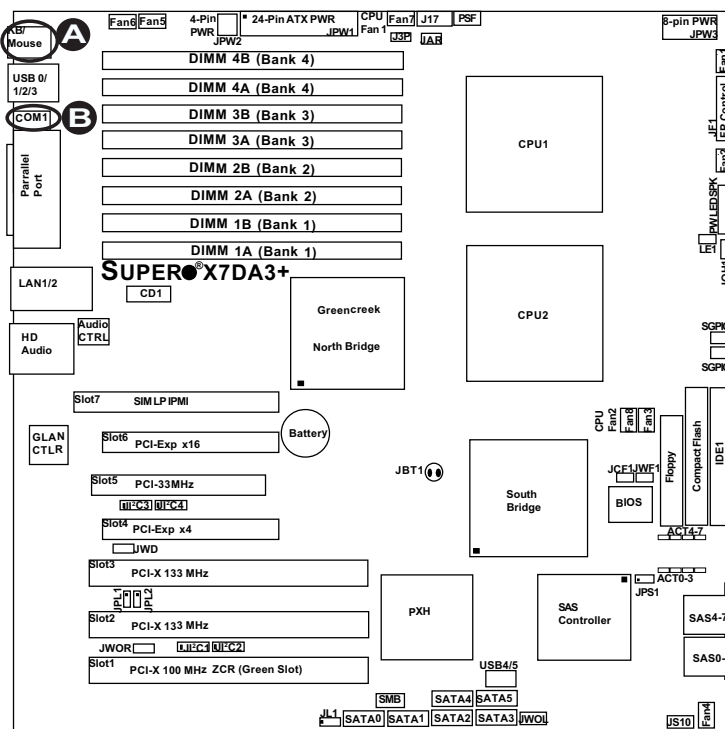

A. Keyboard/Mouse

B. COM1

Wake-On-Ring

The Wake-On-Ring header is designated JWOR. This function allows your computer to receive and be "woken up" by an incoming call to the modem when the system is in the suspend state. See the table on the right for pin definitions. You must have a Wake-On-Ring card and cable to use this feature.

Wake-On-Ring Pin Definitions (JWOR)	
Pin#	Definition
1	Ground
2	Wake-up

Wake-On-LAN

The Wake-On-LAN header is located at JWOL on the motherboard. See the table on the right for pin definitions. (You must also have a LAN card with a Wake-On-LAN connector and cable to use this feature.)

Wake-On-LAN Pin Definitions (JWOL)	
Pin#	Definition
1	+5V Standby
2	Ground
3	Wake-up

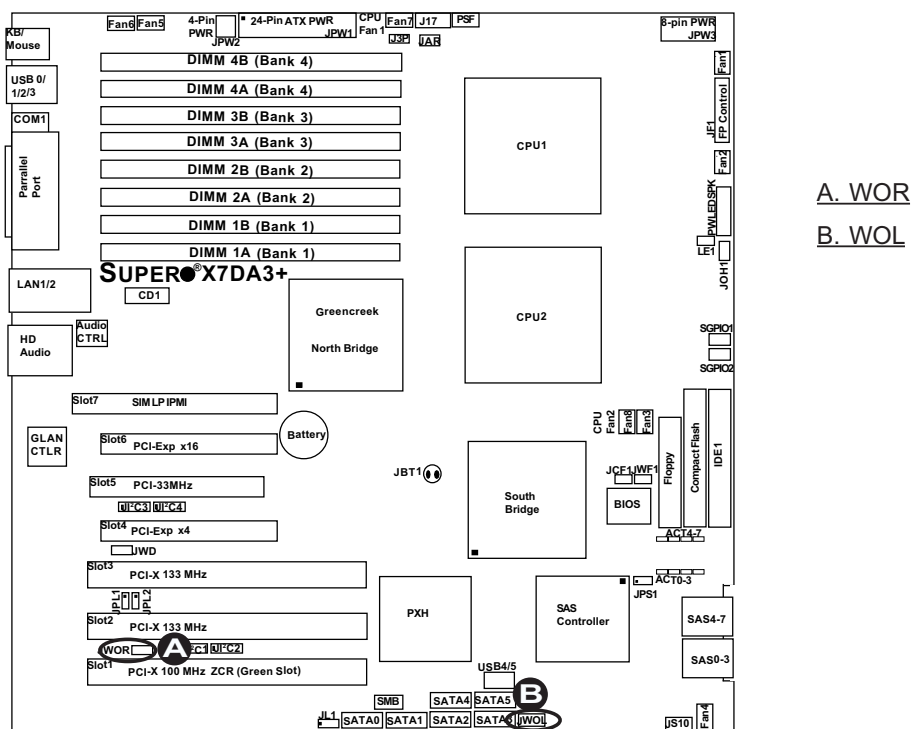

GLAN 1/2 (Giga-bit Ethernet Ports)

Two G-bit Ethernet ports are located at JLAN1 on the IO backplane. This port accepts RJ45 type cables.



Power LED/Speaker

On the JD1 header, pins 1-3 are for a power LED and pins 4-7 are for the speaker. See the table on the right for speaker pin definitions. **Note:** The speaker connector pins are to be used with an external speaker. If you wish to use the onboard speaker, you should close pins 6-7 with a jumper.

Speaker Connector	
Pin Setting	Definition
Pins 6-7	Internal Speaker
Pins 4-7	External Speaker

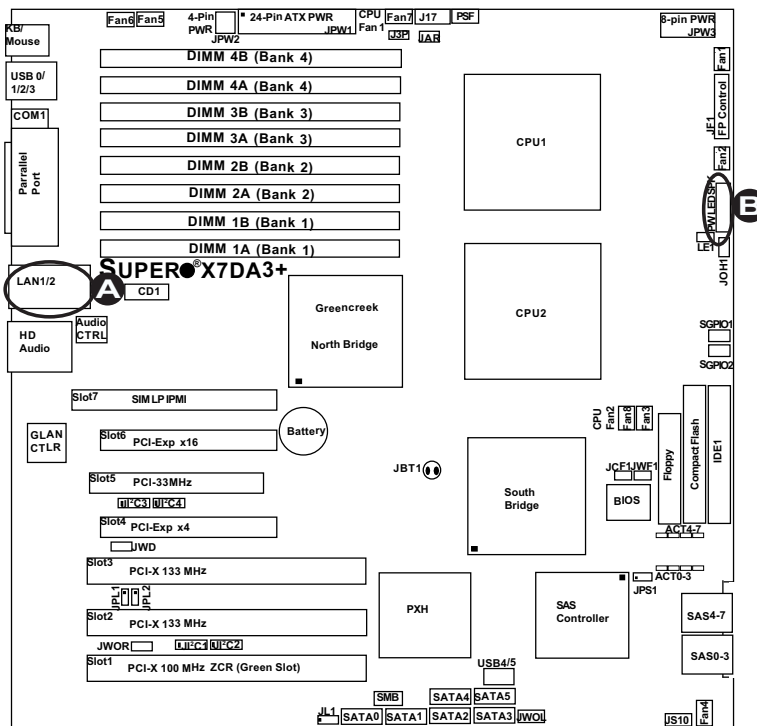

- A. GLAN1/2
- B. PWR LED/Speaker

Power Fault (PWR Supply Failure)

Connect a cable from your power supply to the Power Fail header (PSF) to provide warning of power supply failure. This warning signal is passed through the PWR_LED pin to indicate of a power failure on the chassis. See the table on the right for pin definitions.

PWR Supply Fail LED Pin Definitions	
Pin#	Definition
1	PWR 1: Fail
2	PWR 2: Fail
3	PWR 3: Fail
4	Signal: Alarm Reset

Note: This feature is only available when using Supermicro redundant power supplies.

Overheat LED/Fan Fail (JOH1)

The JOH1 header is used to connect an LED to indicate chassis overheating. This LED blinks when there is a fan failure. Refer to the table on right for pin definitions.

Overheat LED Pin Definitions	
Pin#	Definition
1	5vDC
2	OH Active

OH/Fan Fail LED	
State	Message
Solid	Overheat
Blinking	Fan Fail

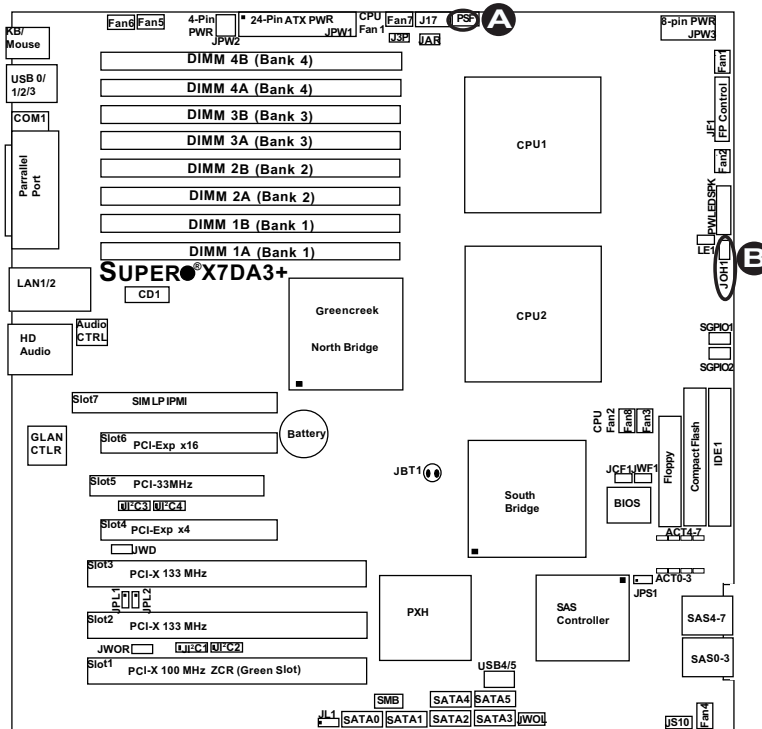

A. Power Fault
B. Overheat LED

SMB

A System Management Bus header is located at J18. Connect the appropriate cable here to utilize SMB on your system.

SMB Header Pin Definitions	
Pin#	Definition
1	Data
2	Ground
3	Clock
4	No Connection

Power SMB (I²C) Connector

Power SMB (I²C) Connector (J17) monitors onboard power supply, fan and system temperature. See the table on the right for pin definitions.

PWR SMB Pin Definitions	
Pin#	Definition
1	Clock
2	Data
3	PWR Fail
4	Ground
5	+3.3V

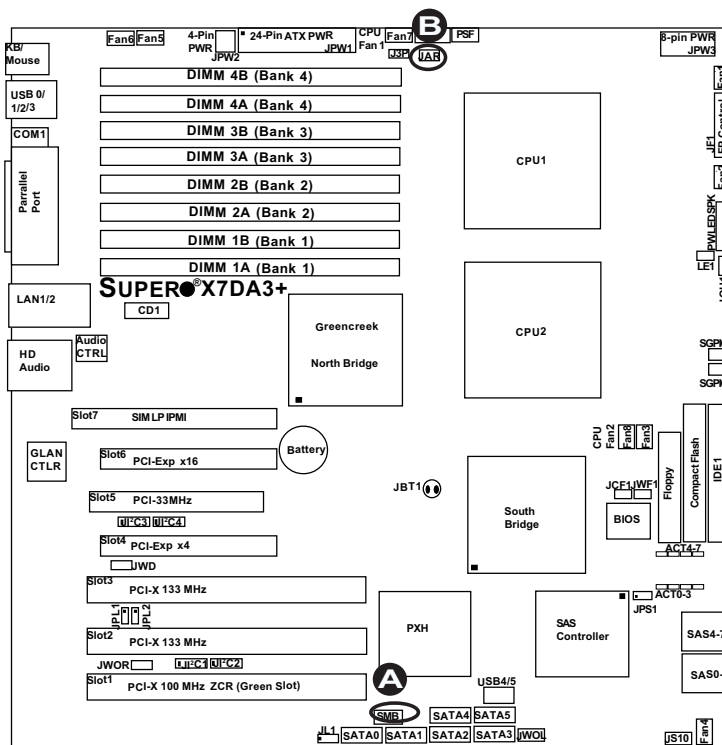

- A. SMB
- B. PWR SMB

Compact Flash Card PWR Connector

A Compact Flash Card Power Connector is located at JWF1. For the Compact Flash Card to work properly, you will need to configure the Jumper-JCF1 properly and connect a Compact Flash Card power cable to JWF1 first. Refer to the board layout below for the location.

Compact Flash Card PWR Connector	
Jumper	Definition
On	Compact Flash Power On
Off	Compact Flash Power Off

SGPIO Headers

There are two SGPIO (Serial General Purpose Input/Output) headers (J29, J30) located on the motherboard. These headers support serial link interfaces for the onboard SATA connectors. See the table on the right for pin definitions. Refer to the board layout below for the location.

SGPIO Pin Definitions			
Pin#	Definition	Pin	Definition
1	NC	2	NC
3	Ground	4	DATA Out
5	Load	6	Ground
7	Clock	8	NC

Note: NC= No Connections

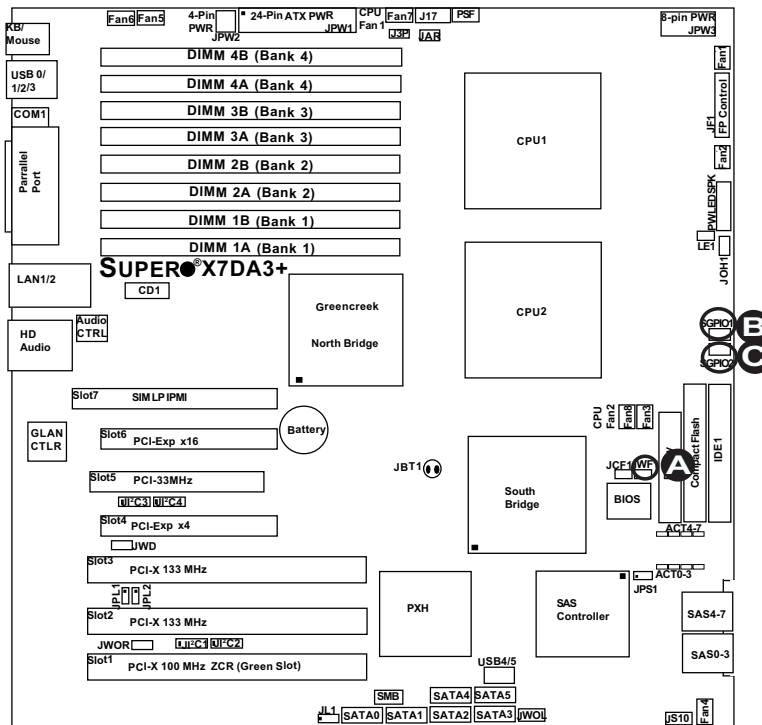

- A. Compact Flash PWR
- B. SGPIO 1
- C. SGPIO 2

High Definition Audio (HD Audio)

The X7DA3+ features a 7.1+2 Channel High Definition Audio (HDA) (JC1) codecs that provide 10 DAC channels, simultaneously supporting 7.1 sound playback with 2 channels of independent stereo sound output (multiple streaming) through the front panel stereo out (for front L&R, rear L&R), center and subwoofer speakers. Use the advanced software included in the CD-ROM that came with your motherboard and enable the Audio settings in the BIOS to use this feature. Sound is then output through the Line In, Line Out and MIC jacks (see the graphics at right). Be sure to enable this function in the BIOS to use this feature.

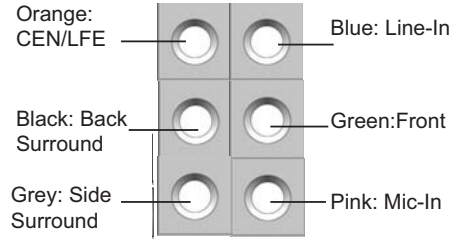

CD Connector

A CD connectors (CD1) is located below the memory modules. See the tables on the right for pin definitions.

CD1 Pin Definition	
Pin#	Definition
1	Left
2	Ground
3	Ground
4	Right

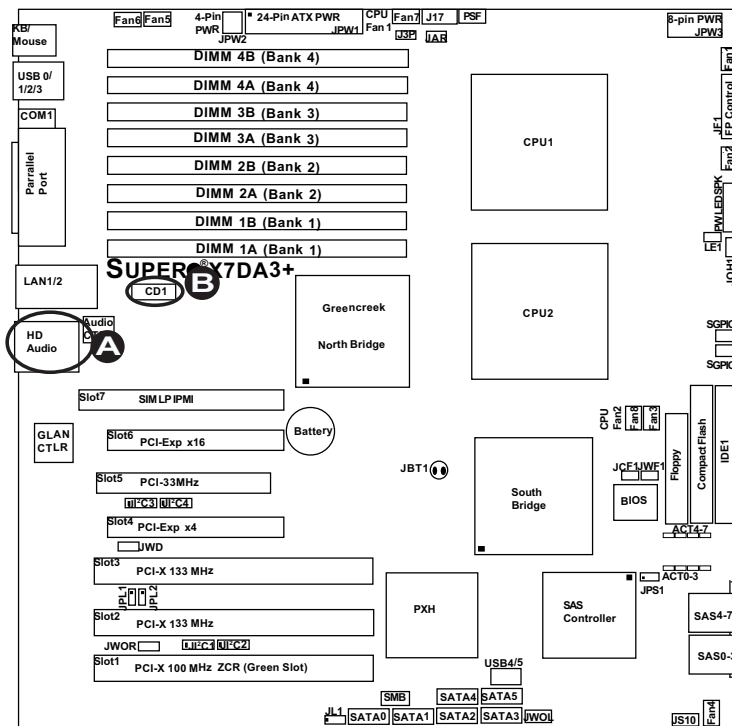

A. HD Audio

B. CD1

2-7 Jumper Settings

Explanation of Jumpers

To modify the operation of the motherboard, jumpers can be used to choose between optional settings. Jumpers create shorts between two pins to change the function of the connector. Pin 1 is identified with a square solder pad on the printed circuit board. See the motherboard layout pages for jumper locations.

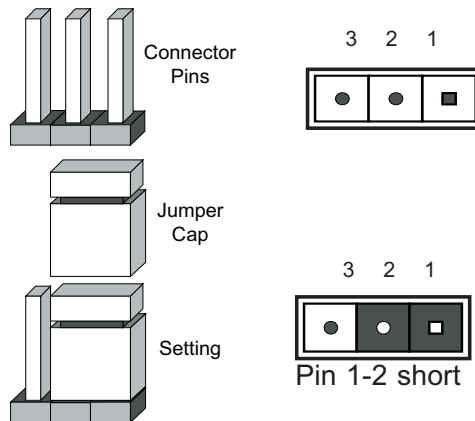

Note: On two pin jumpers, "Closed" means the jumper is on and "Open" means the jumper is off the pins.

GLAN Enable/Disable

JPL1/JPL2 enable or disable GLAN Port1 and GLAN Port2 on the motherboard. See the table on the right for jumper settings. The default setting is enabled.

GLAN Enable	
Pin#	Definition
1-2	Enabled (default)
2-3	Disabled

- A. GLAN Port1 Enable
- B. GLAN Port2 Enable

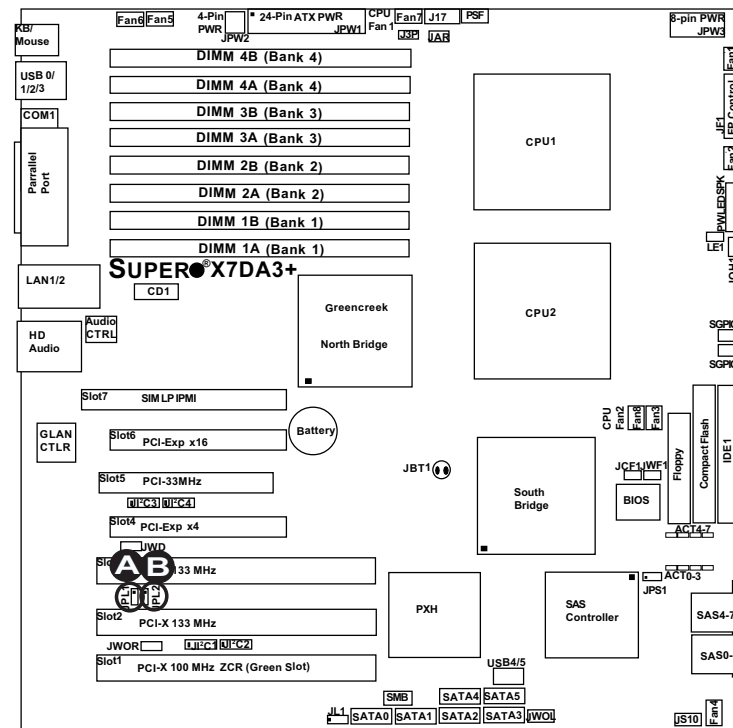

CMOS Clear

JBT1 is used to clear CMOS. Instead of pins, this "jumper" consists of contact pads to prevent the accidental clearing of CMOS. To clear CMOS, use a metal object such as a small screwdriver to touch both pads at the same time to short the connection. Always remove the AC power cord from the system before clearing CMOS.

Note: For an ATX power supply, you must completely shut down the system, remove the AC power cord and then short JBT1 to clear CMOS.

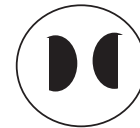

Watch Dog Enable/Disable

Watch Dog is a system monitor that can reboot the system when a software application hangs. Close Pins 1-2 to reset the system if an application hangs. Close Pins 2-3 to generate a non-maskable interrupt signal for the application that hangs. See the table on the right for jumper settings. Watch Dog must also be enabled in the BIOS.

Watch Dog Jumper Settings (JWD)	
Jumper Setting	Definition
Pins 1-2	Reset (default)
Pins 2-3	NMI
Open	Disabled

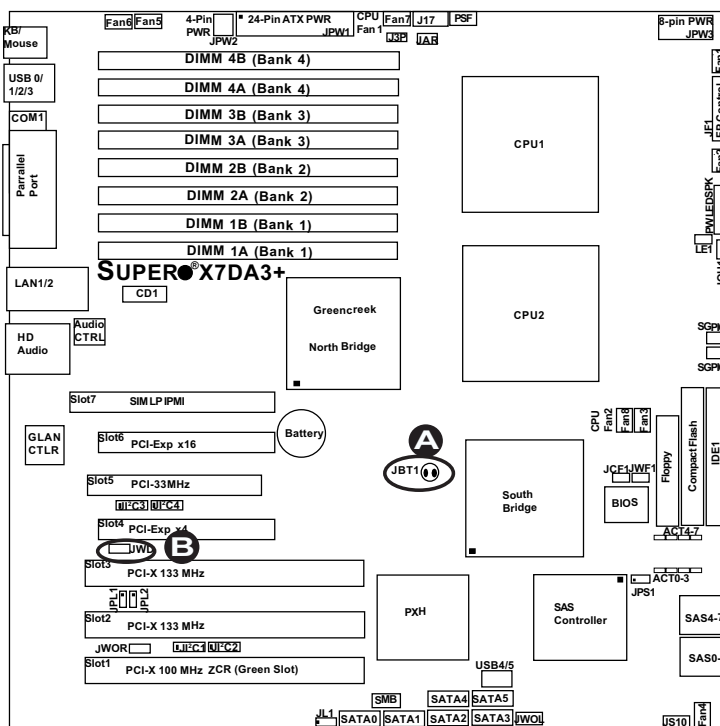

- A. Clear CMOS
- B. Watch Dog Enable

3rd PWR Supply PWR Fault Detect (J3P)

The system can notify you in the event of a power supply failure. This feature is available when three power supply units are installed in the chassis with one acting as a backup. If you only have one or two power supply units installed, you should disable this (the default setting) with J3P to prevent false alarms.

3rd PWR Supply PWR Fault Jumper Settings	
Jumper Setting	Definition
Closed	Enabled
Open	Disabled (Default)

SAS Controller Enable/Disable

JPS1 enables or disables the AIC 9140W Adaptec SAS Controller on the motherboard. See the table on the right for jumper settings. The default setting is enabled.

SAS Controller Enable Jumper Settings	
Jumper Setting	Definition
Pins 1-2	Enabled (default)
Pins 2-3	Disabled

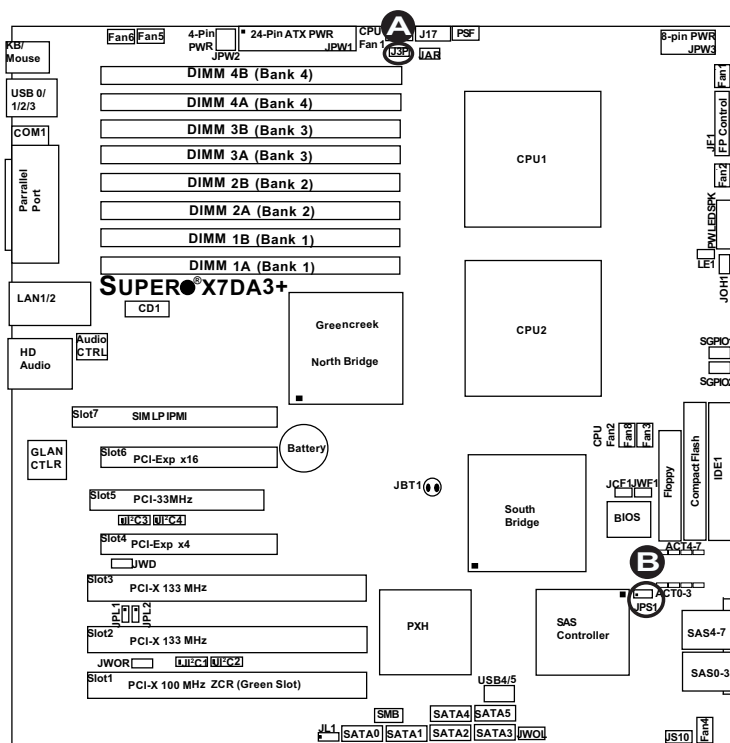

A. 3rd PWR Fail
B. SAS Enable

Compact Flash Master/Slave Select

A Compact Flash Master/Slave Select Jumper is located at JCF1. Close this jumper to enable Compact Flash Card. For the Compact Flash Card or the Compact Flash Jumper (JCF1) to work properly, you will need to connect the Compact Flash Card power cable to JWF1 first. Refer to the board layout below for the location.

Compact Flash Card Master/Slave Select	
Jumper	Definition
Open	Slave
Closed	Master

Alarm Reset

If three power supplies are installed and Alarm Reset (JAR) is enabled, the system will notify you when any of the three power modules fails. Connect JAR to a micro-switch to enable you to turn off the alarm that is activated when a power module fails. See the table on the right for pin definitions.

Alarm Reset	
Pin Setting	Definition
Pin 1	Ground
Pin 2	+5V

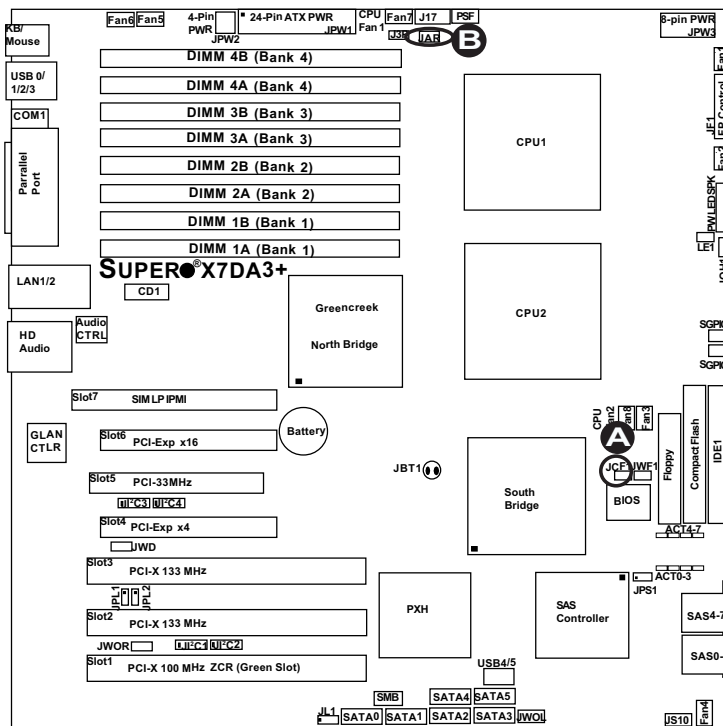

- A. Compact Flash Master/Slave Select
- B. Alarm Reset

SMB to PCI-X/PCI-E Slots

Jumpers JI²C1/JI²C2 allow you to connect PCI-X Slots to the System Management Bus and Jumpers JI²C3/JI²C4 allow you to connect PCI-Exp. Slots to the System Management Bus. See the table on the right for jumper settings.

SMBus to PCI-X/PCI-Exp Slots Jumper Settings	
Jumper Setting	Definition
Pins 1-2	Enabled
Pins 2-3	Disabled (Default)

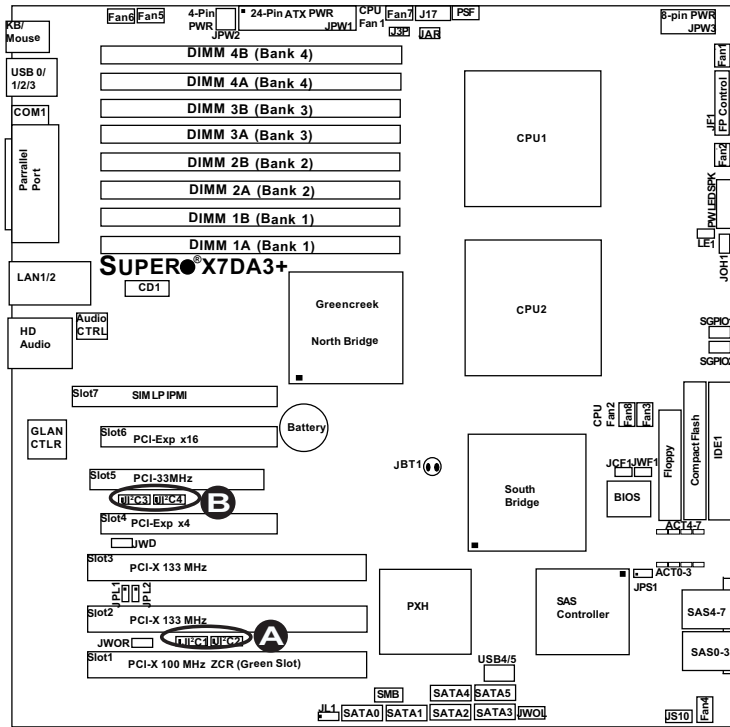

- A. JI²C 1/2
- B. JI²C 3/4
- C. SAS Enable

2-8 Onboard Indicators

GLAN LEDs

There are two GLAN ports on the motherboard. Each Gigabit Ethernet LAN port has two LEDs. The green LED indicates activity, while the Link LED may be green, amber or off to indicate the speed of the connection. See the tables at right for more information.

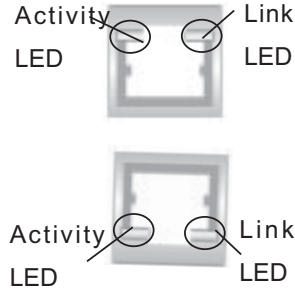

GLAN Activity Indicator		
Color	Status	Definition
Green	Flashing	Active

Onboard Power LED

There is an Onboard Power LED located on the motherboard. When this LED is lit, the onboard power is on. Be sure to turn off the system and unplug the power cord before removing or installing components. See the layout below for the LED location.

GLAN Link Indicator	
LED Color	Definition
Off	No Connection or 10 Mbps
Green (On)	100 Mbps
Amber (On)	1 Gbps

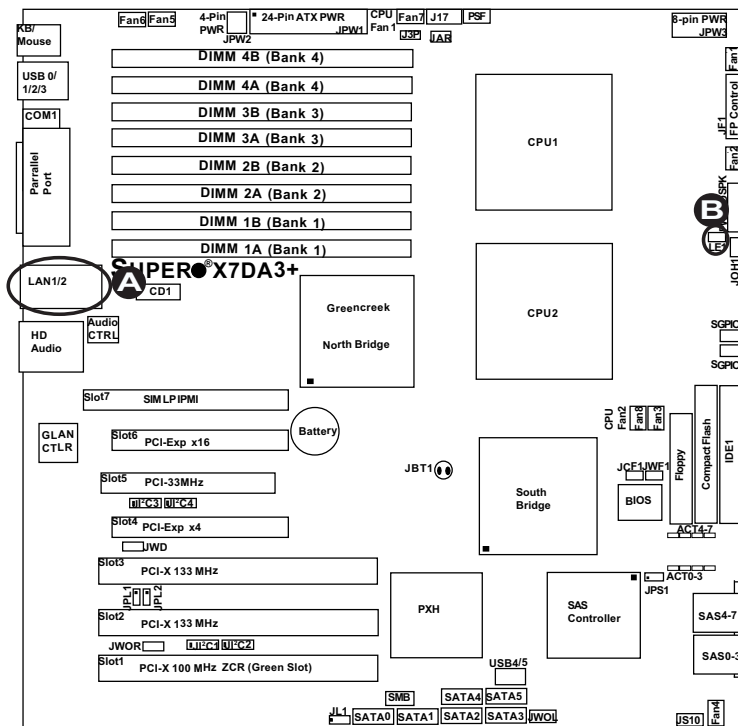

- A. GLAN Port1 LEDs
- B. Standby PWR LED

Onboard SAS Activity LED Indicators

There are eight Onboard SAS Activity LED indicators on the X7DA3+. LED Indicators Act#0 to Act#7 indicate onboard SAS connector activities. See the table on the right for more information.

Onboard SAS_Activity_LED Indicators (Note: Act=Active)			
Act#	Definition	Act#	Definition
Act#0	SAS0:Act	Act#4	SAS4:Act
Act#1	SAS1:Act	Act#5	SAS5:Act
Act#2	SAS2:Act	Act#6	SAS6:Act
Act#3	SAS3:Act	Act#7	SAS7:Act

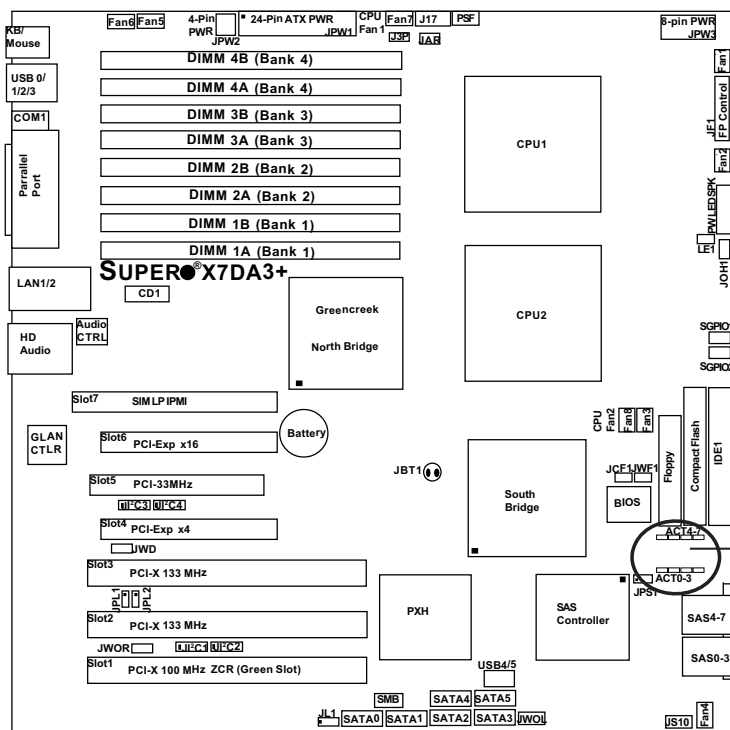

- A. SAS Act. #0-#3 LEDs
- B. SAS Act. #4-#7 LEDs

2-9 Parallel Port, Floppy Drive, Hard Disk Drive and SIMLP IPMI Connections

Note the following when connecting the floppy and hard disk drive cables:

- The floppy disk drive cable has seven twisted wires.
- A red mark on a wire typically designates the location of pin 1.
- A single floppy disk drive ribbon cable has two connectors to provide for two floppy disk drives. The connector with twisted wires always connects to drive A, and the connector that does not have twisted wires always connects to drive B.

Parallel (Printer) Port Connector

The parallel (printer) port is located at J21. See the table on the right for pin definitions.

Parallel (Printer) Port Connector Pin Definitions			
Pin#	Definition	Pin #	Definition
1	Strobe-	2	Auto Feed-
3	Data Bit 0	4	Error-
5	Data Bit 1	6	Init-
7	Data Bit 2	8	SLCT IN-
9	Data Bit 3	10	GND
11	Data Bit 4	12	GND
13	Data Bit 5	14	GND
15	Data Bit 6	16	GND
17	Data Bit 7	18	GND
19	ACK	20	GND
21	BUSY	22	Write Data
23	PE	24	Write Gate
25	SLCT	26	NC

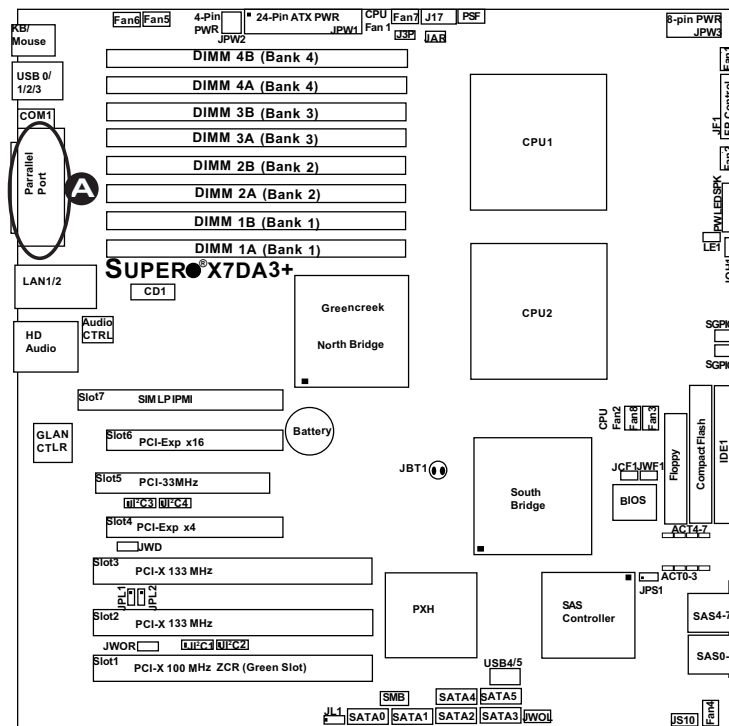

A. Parallel Port

Floppy Connector

The floppy connector is located at J22. See the table below for pin definitions.

Floppy Drive Connector Pin Definitions (Floppy)			
Pin#	Definition	Pin #	Definition
1	Ground	2	FDHDIN
3	Ground	4	Reserved
5	Key	6	FDEDIN
7	Ground	8	Index
9	Ground	10	Motor Enable
11	Ground	12	Drive Select B
13	Ground	14	Drive Select B
15	Ground	16	Motor Enable
17	Ground	18	DIR
19	Ground	20	STEP
21	Ground	22	Write Data
23	Ground	24	Write Gate
25	Ground	26	Track 00
27	Ground	28	Write Protect
29	Ground	30	Read Data
31	Ground	32	Side 1 Select
33	Ground	34	Diskette

SIMLP IPMI Slot

There is a SIM Low Profile IPMI Slot on the motherboard. Refer to the layout below for the SIMLP IPMI Slot location.

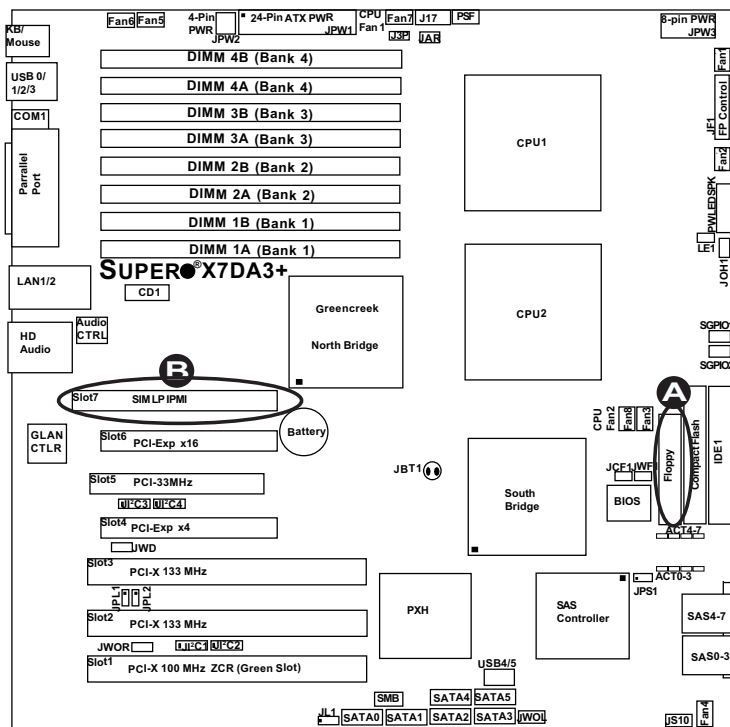

A. Floppy

B. SIMLP IPMI

IDE Connectors

There are two IDE Connectors (JIDE1: Blue, JIDE2: White) on the motherboard. The blue IDE connector (JIDE1) is designated the Primary IDE Drive. The white IDE connector (JIDE2) is designated as the Secondary IDE Drive, reserved for Compact Flash Card use only. (See the note below.) See the table on the right for pin definitions.

Note: JIDE2 (the white slot) is reserved for Compact Flash Card use only. Do not use it for other devices. If JIDE2 is populated with a Compact Flash Card, JIDE1 (the blue slot) will be available for one device only. For the Compact Flash Card to work properly, you will need to connect a power cable to JWF1 first.

IDE Drive Connectors Pin Definitions			
Pin#	Definition	Pin #	Definition
1	Reset IDE	2	Ground
3	Host Data 7	4	Host Data 8
5	Host Data 6	6	Host Data 9
7	Host Data 5	8	Host Data 10
9	Host Data 4	10	Host Data 11
11	Host Data 3	12	Host Data 12
13	Host Data 2	14	Host Data 13
15	Host Data 1	16	Host Data 14
17	Host Data 0	18	Host Data 15
19	Ground	20	Key
21	DRQ3	22	Ground
23	I/O Write	24	Ground
25	I/O Read	26	Ground
27	IOCHRDY	28	BALE
29	DACK3	30	Ground
31	IRQ14	32	IOCS16
33	Addr1	34	Ground
35	Addr0	36	Addr2
37	Chip Select 0	38	Chip Select 1
39	Activity	40	Ground

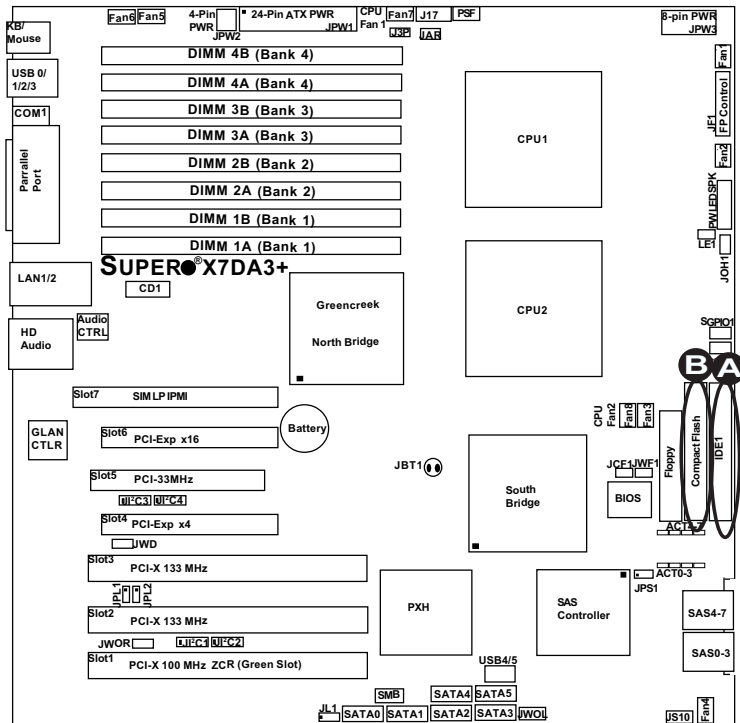

- A. IDE#1
- B. IDE#2 (Compact Flash)

SAS Connectors

There are eight Serial Attached SCSI (SAS#0-#3, SAS#4-#7) on the motherboard. See the tables on the right for pin definitions.

SAS Connector Pin Definitions			
Pin#	Definition	Pin #	Definition
A1	Ground	B1	Ground
A2	RX 0+	B2	TX 0+
A3	RX 0-	B3	TX 0-
A4	Ground	B4	Ground
A5	RX 1+	B5	TX 1+
A6	RX 1-	B6	TX 1-
A7	Ground	B7	Ground
A8	SB7	B8	SB0
A9	SB3	B9	SB1
A10	SB4	B10	SB2
A11	SB5	B11	SB6
A12	Ground	B12	Ground
A13	RX 2+	B13	TX 2+
A14	RX 2-	B14	TX 2-
A15	Ground	B15	Ground
A16	RX 3+	B16	TX 3+
A17	RX 3-	B17	TX 3-
A18	Ground	B18	Ground

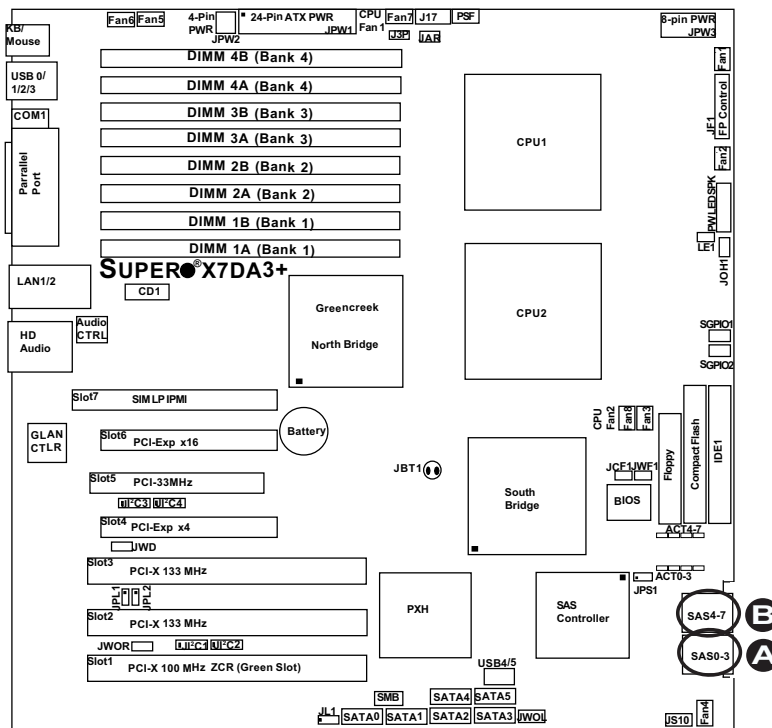

A. SAS #0-#3

B. SAS #4-#7

Chapter 3

Troubleshooting

3-1 Troubleshooting Procedures

Use the following procedures to troubleshoot your system. If you have followed all of the procedures below and still need assistance, refer to the 'Technical Support Procedures' and/or 'Returning Merchandise for Service' section(s) in this chapter.

Note: Always disconnect the power cord before adding, changing or installing any hardware components.

Before Power On

1. Make sure that there are no short circuits between the motherboard and chassis.
2. Disconnect all ribbon/wire cables from the motherboard, including those for the keyboard and mouse.
3. Remove all add-on cards.
4. Install one CPU (making sure it is fully seated) and connect the chassis speaker and the power LED to the motherboard. (Check all jumper settings as well.)

No Power

1. Make sure that there are no short circuits between the motherboard and the chassis.
2. Make sure that all jumpers are set to their default positions.
3. Check that the 115V/230V switch on the power supply is properly set.
4. Turn the power switch on and off to test the system.
5. The battery on your motherboard may be old. Check to make sure that it still supplies ~3VDC. If it does not, replace it with a new one.

No Video

1. If the power is on, but you have no video, remove all the add-on cards and cables.
2. Use the speaker to determine if any beep codes exist. Refer to the Appendix B for details on beep codes.
3. Remove all memory modules and turn on the system. (If the alarm is on, check the specs of the memory, reset the memory or try a different one.)

Losing the System's Setup Configuration

1. Make sure that you are using a high quality power supply. A poor quality power supply may cause the system to lose the CMOS setup information. Refer to Section 1-6 for details on recommended power supplies.
2. The battery on your motherboard may be old. Check to make sure that it still supplies ~3VDC. If it does not, replace it with a new one.
3. If the above steps do not fix the Setup Configuration problem, contact your vendor for repairs.

NOTE

If you are a system integrator, VAR or OEM, a POST diagnostics card is recommended. For I/O port 80h codes, refer to App. B.

Memory Errors

1. Make sure that the DIMM modules are properly and fully installed.
2. Check if different speeds of DIMMs have been installed and make sure that the BIOS setup is configured for the fastest speed of RAM used. It is recommended to use the same RAM speed for all DIMMs in the system.
3. Make sure you are using the correct type of DDR2 FBD (Fully Buffered) ECC 533/667 SDRAM (recommended by the manufacturer.)
4. Check for bad DIMM modules or slots by swapping a single module between four slots and noting the results.
5. Make sure that all memory modules are fully seated in their slots. As an interleaved memory scheme is used, you must install pair(s) of modules at a time, beginning with Branch 1, then Branch 2, and so on (see Page 2-6).
6. Check the position of the 115V/230V switch on the power supply.

3-2 Technical Support Procedures

Before contacting Technical Support, please take the following steps. Also, note that as a motherboard manufacturer, Super Micro does not sell directly to end-users, so it is best to first check with your distributor or reseller for troubleshooting services. They should know of any possible problem(s) with the specific system configuration that was sold to you.

1. Please go through the 'Troubleshooting Procedures' and 'Frequently Asked Question' (FAQ) sections in this chapter or see the FAQs on our web site <http://www.supermicro.com/support/faqs/> before contacting Technical Support.
 2. BIOS upgrades can be downloaded from our web site at <http://www.supermicro.com/support/bios/>.
-

Note: Not all BIOS can be flashed. It depends on the modifications to the boot block code.

3. If you still cannot resolve the problem, make sure to have the following information ready when contacting Super Micro for technical support:

- Motherboard model and PCB revision number
- BIOS release date/version (this can be seen on the initial display when your system first boots up)
- System configuration

An example of a Technical Support form is on our web site at <http://www.supermicro.com/support/contact.cfm/>).

4. Distributors: For immediate assistance, please have your account number ready when placing a call to our technical support department. We can be reached by e-mail at support@supermicro.com or by fax at: (408) 503-8000, option 2.

3-3 Frequently Asked Questions

Question: What are the various types of memory that my motherboard can support?

Answer: The X7DA3+ has eight 240-pin DIMM slots that support DDR2 FBD ECC 533/667 SDRAM modules. It is strongly recommended that you do not mix memory modules of different speeds and sizes.

Question: How do I update my BIOS?

Answer: It is recommended that you **do not** upgrade your BIOS if you are experiencing no problems with your system. Updated BIOS files are located on our web site at <http://www.supermicro.com/support/bios/>. Please check our BIOS warning message and the information on how to update your BIOS on our web site. Also, check the current BIOS revision and make sure that it is newer than your BIOS before downloading. Select your motherboard model and download the BIOS file to your computer. Unzip the BIOS files onto a bootable floppy and reboot your system. Follow the Readme.txt to continue flashing the BIOS.



(Warning: Do not shut down or reset the system while updating BIOS to prevent possible system boot failure!)

Question: What's on the CD that came with my motherboard?

Answer: The supplied compact disc has quite a few drivers and programs that will greatly enhance your system. We recommend that you review the CD and install the applications you need. Applications on the CD include chipset drivers for Windows and security and audio drivers.

3-4 Returning Merchandise for Service

A receipt or copy of your invoice marked with the date of purchase is required before any warranty service will be rendered. You can obtain service by calling your vendor for a Returned Merchandise Authorization (RMA) number. When returning to the manufacturer, the RMA number should be prominently displayed on the outside of the shipping carton, and mailed prepaid or hand-carried. Shipping and handling charges will be applied for all orders that must be mailed when service is complete.

This warranty only covers normal consumer use and does not cover damages incurred in shipping or from failure due to the alteration, misuse, abuse or improper maintenance of products.

During the warranty period, contact your distributor first for any product problems.

Chapter 4

BIOS

4-1 Introduction

This chapter describes the Phoenix BIOS™ Setup utility for the X7DA3+. The Phoenix ROM BIOS is stored in a flash chip and can be easily upgraded using a floppy disk-based program.

Note: Due to periodic changes to the BIOS, some settings may have been added or deleted and might not yet be recorded in this manual. Please refer to the Manual Download area of the Supermicro web site <<http://www.supermicro.com>> for any changes to the BIOS that may not be reflected in this manual.

System BIOS

The BIOS is the Basic Input Output System used in all IBM® PC, XT™, AT®, and PS/2® compatible computers. The Phoenix BIOS stores the system parameters, types of disk drives, video displays, etc. in the CMOS. The CMOS memory requires very little electrical power. When the computer is turned off, a backup battery provides power to the CMOS logic, enabling it to retain system parameters. When a computer is powered on, the computer is configured with the values stored in the CMOS logic by the system BIOS, which gains control at boot up.

How To Change the Configuration Data

The CMOS information that determines the system parameters may be changed by entering the BIOS Setup utility. This Setup utility can be accessed by pressing the <Delete> key at the appropriate time during system boot. (See below.)

Starting the Setup Utility

Normally, the only visible POST (Power On Self Test) routine is the memory test. As the memory is being tested, press the <Delete> key to enter the main menu of the BIOS Setup utility. From the main menu, you can access the other setup screens, such as the Security and Power menus. Beginning with Section 4-3, detailed descriptions are given for each parameter setting in the Setup utility.



Warning: Do not shut down or reset the system while updating BIOS to prevent possible boot failure.

4-2 Running Setup

Default settings are in bold text unless otherwise noted.

The BIOS setup options described in this section are selected by choosing the appropriate text from the main BIOS Setup screen. All displayed text is described in this section, although the screen display is often all you need to understand how to set the options (see the next page).

When you first power on the computer, the Phoenix BIOS™ is immediately activated.

While the BIOS is in control, the Setup program can be activated in one of two ways:

1. By pressing <Delete> immediately after turning the system on, or
2. When the message shown below appears briefly at the bottom of the screen during the POST (Power On Self-Test), press the <Delete> key to activate the main Setup menu:

Press the <Delete> key to enter Setup

4-3 Main BIOS Setup

All main Setup options are described in this section. The main BIOS Setup screen is displayed below.

Use the Up/Down arrow keys to move between the different settings in each menu. Use the Left/Right arrow keys to change the options for each setting.

Press the <Esc> key to exit the CMOS Setup Menu. The next section describes in detail how to navigate through the menus.

Items that use submenus are indicated with the ► icon. With the item highlighted, press the <Enter> key to access the submenu.

Main BIOS Setup Menu

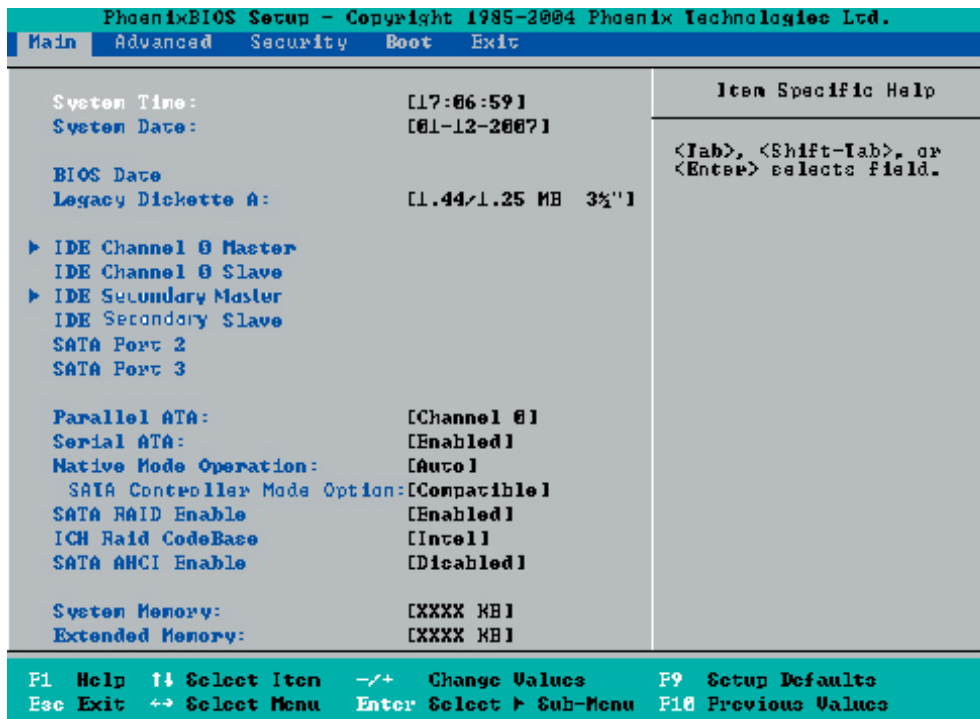

Main Setup Features

System Time

To set the system date and time, key in the correct information in the appropriate fields. Then press the <Enter> key to save the data.

System Date

Using the arrow keys, highlight the month, day and year fields, and enter the correct data. Press the <Enter> key to save the data.

BIOS Date

The item displays the date that the BIOS was built.

Legacy Diskette A

This setting allows the user to set the type of floppy disk drive installed as diskette A. The options are Disabled, 360Kb 5.25 in, 1.2MB 5.25 in, 720Kb 3.5 in, **1.44/1.25MB**, 3.5 in and 2.88MB 3.5 in.

► IDE Channel 0 Master/Slave, Secondary Master/Slave, SATA Port2, SATA Port3

These settings allow the user to set the parameters of IDE Channel 0 Master/Slave, Secondary Master/Slave, SATA Port2, SATA Port3 slots. Hit <Enter> to activate the following submenu screen for detailed options of these items. Set the correct configurations accordingly. The items included in the submenu are:

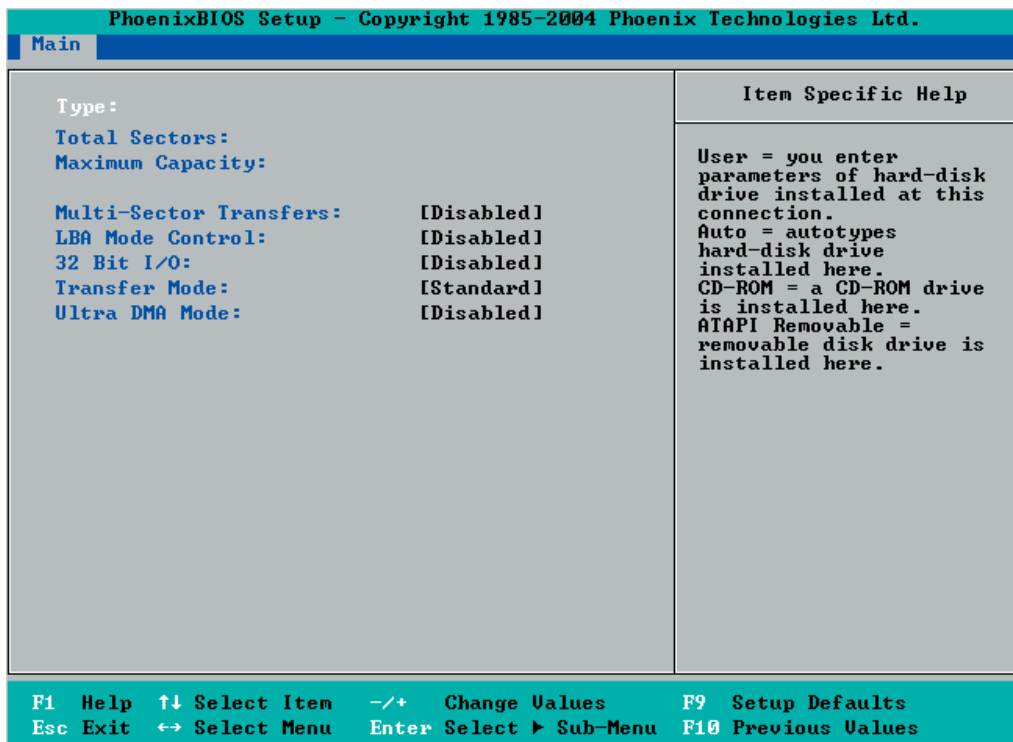

Type

This option allows the user to select the type of IDE hard drive. The option **Auto** will allow the BIOS to automatically configure the parameters of the HDD installed at the connection. Enter a number between 1 to 39 to select a predetermined HDD type. Select User to allow the user to enter the parameters of the HDD installed. Select CDROM if a CDROM drive is installed. Select ATAPI if a removable disk drive is installed.

Total Sectors: This item displays the number of total sectors available in the LBA Format.

Maximum Capacity: This item displays the maximum capacity in the LBA Format.

Multi-Sector Transfer

This item allows the user to specify the number of sectors per block to be used in multi-sector transfer. The options are **Disabled**, 4 Sectors, 8 Sectors, and 16 Sectors.

LBA Mode Control

This item determines whether the Phoenix BIOS will access the IDE Channel 0 Master Device via the LBA mode. The options are **Enabled** and Disabled.

32 Bit I/O

This option allows the user to enable or disable the function of 32-bit data transfer. The options are Enabled and **Disabled**.

Transfer Mode

This option allows the user to set the transfer mode. The options are **Standard**, Fast PIO1, Fast PIO2, Fast PIO3, Fast PIO4, FPIO3/DMA1 and **FPIO4/DMA2**.

Ultra DMA Mode

This option allows the user to select Ultra DMA Mode. The options are **Disabled**, Mode 0, Mode 1, **Mode 2**, Mode 3, Mode 4, and Mode 5.

Parallel ATA

This setting allows the user to enable or disable the function of Parallel ATA. The options are Disabled and **Enabled**.

Serial ATA

This setting allows the user to enable or disable the function of Serial ATA. The options are Disabled and **Enabled**.

Native Mode Operation

This feature allows you to select Serial ATA for SATA or Auto (Native Mode) for ATA. The options are: Serial ATA and **Auto**.

SATA Controller Mode

Select **Compatible** to allow the SATA and PATA drives to be automatically-detected and be placed in the Legacy Mode by the BIOS. Select Enhanced to allow the SATA and PATA drives to be to be automatically-detected and be placed in the Native IDE Mode. (**Note: The Enhanced mode is supported by the Windows 2000 OS or a later version.**)

Serial ATA (SATA) RAID Enable (Available when SATA Controller is enabled.)

Select Enable to enable Serial ATA RAID Functions. (For the Windows OS environment, use the RAID driver if this feature is set to Enabled. When this item is set to Enabled, the item: "ICH RAID Code Base" will be available for you to select either Intel or Adaptec Host RAID firmware to be activated. If this item is set to **Disabled**, the item-SATA AHCI Enable will be available.) The options are Enabled and **Disabled**.

ICH RAID Code Base (Available when SATA RAID is enabled.)

Select Intel to enable Intel's SATA RAID firmware. Select Adaptec to use Adaptec's HostRAID firmware. The options are **Intel** and Adaptec.

SATA AHCI (Available when SATA RAID is disabled.)

Select Enable to enable the function of Serial ATA Advanced Host Interface. (Take caution when using this function. This feature is for advanced programmers only. The options are Enabled and **Disabled**.)

System Memory

This display informs you how much system memory is recognized as being present in the system.

Extended Memory

This display informs you how much extended memory is recognized as being present in the system.

4-4 Advanced Setup

Choose Advanced from the Phoenix BIOS Setup Utility main menu with the arrow keys. You should see the following display. The items with a triangle beside them have sub menus that can be accessed by highlighting the item and pressing <Enter>.

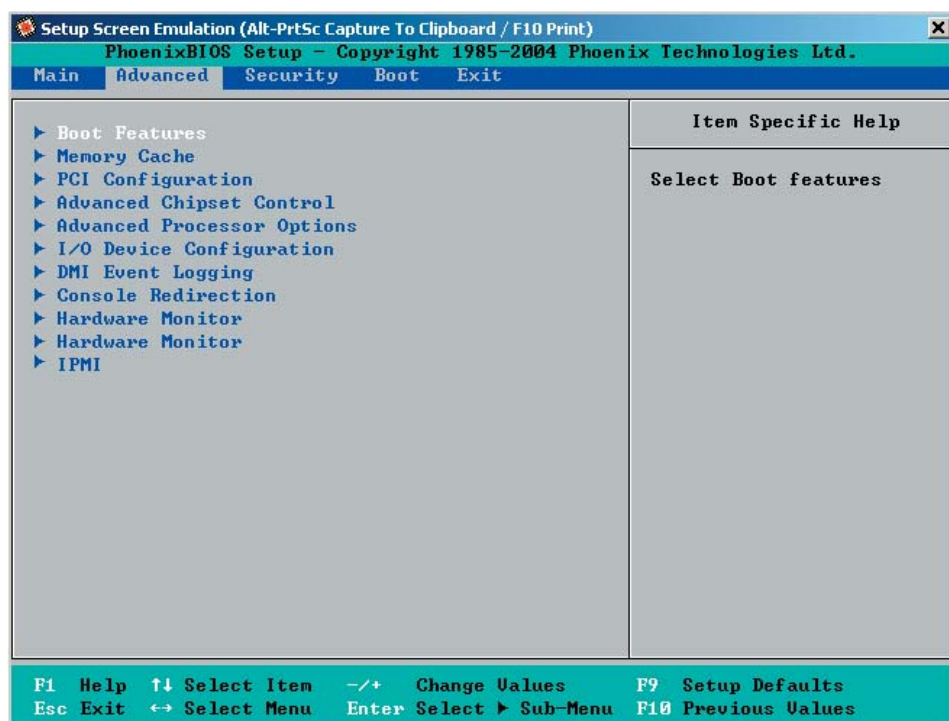

► Boot Features

Access the submenu to make changes to the following settings.

QuickBoot Mode

If enabled, this feature will speed up the POST (Power On Self Test) routine by skipping certain tests after the computer is turned on. The settings are **Enabled** and Disabled. If Disabled, the POST routine will run at normal speed.

Quiet Boot

This setting allows you to **Enable** or Disable the graphic logo screen during boot-up.

POST Errors

Select **Enabled** to temporarily halt system boot and display POST (Power-On-Self Testing) error messages when errors occur during bootup. Select Disable to continue with system boot even when an error occurs. The options are **Enabled** and Disabled.

ACPI Mode

Select **Yes** to use ACPI (Advanced Configuration and Power Interface) power management on your system. The options are **Yes** and No.

ACPI Sleep Mode

This option allows you to decide how you are going to use the ACPI (Advanced Configuration and Power Interface) power management on your system when it is in the sleep mode. The options are **S1**, S1&S3, and S3.

Power Button Behavior

If set to **Instant-Off**, the system will power off immediately as soon as the user hits the power button. If set to 4-sec., the system will power off when the user presses the power button for 4 seconds or longer. The options are **Instant-off** and 4-sec override.

Resume On Modem Ring

Select On to wake your system up when an incoming call is received by your modem. The options are On and **Off**.

Keyboard On Now Function

This feature allows you to determine how a user can power on the system by using the keyboard when it is in S3 or S5 state. Select **Disable** to disable this feature. Select Space to allow the user to power on the system when the user presses the <Space> bar. Select Password to allow the user to power on the system by entering a pre-set password. (The preset password must be 5-character long.)

Power Loss Control

This setting allows you to decide how the system will react when power returns after an unexpected loss of power. The options are Stay Off, Power On, and **Last State**.

Watch Dog

If enabled, this option will automatically reset the system if the system is not active for more than 5 minutes. The options are Enabled and **Disabled**.

Summary Screen

This setting allows you to **Enable** or Disable the summary screen which displays the system configuration during bootup.

► Memory Cache

Cache System BIOS Area

This setting allows you to designate a reserve area in the system memory to be used as a System BIOS buffer to allow the BIOS to write (cache) data into this reserved memory area. Select **Write Protect** to enable this function, and this area will be reserved for BIOS ROM access only. Select Uncached to disable this function and make this area available for other devices.

Cache Video BIOS Area

This setting allows you to designate a reserve area in the system memory to be used as a Video BIOS buffer to allow the BIOS to write (cache) data into this reserved memory area. Select **Write Protect** to enable the function and this area will be reserved for Video BIOS ROM access only. Select Uncached to disable this function and make this area available for other devices.

Cache Base 0-512K

512K to be cached (written) into a buffer, a storage area in Static DRAM (SDRAM) or to be written into L1, L2 cache inside the CPU to speed up CPU operations. Select Uncached to disable this function. Select Write Through to allow data to be cached into the buffer and written into the system memory at the same time. Select Write Protect to prevent data from being written into the base memory area of Block 0-512K. Select Write Back to allow the CPU to write data back directly from the buffer without writing data to the System Memory for fast CPU data processing and operation. The options are Uncached, Write Through, Write Protect, and **Write Back**.

Cache Base 512K-640K

If enabled, this feature will allow the data stored in the memory area: 512K-640K to be cached (written) into a buffer, a storage area in the Static DRAM (SDRAM) or written into L1, L2, L3 cache inside the CPU to speed up CPU operations.

Select **Uncached** to disable this function. Select **Write Through** to allow data to be cached into the buffer and written into the system memory at the same time. Select **Write Protect** to prevent data from being written into the base memory area of Block 512-640K. Select **Write Back** to allow the CPU to write data back directly from the buffer without writing data to the System Memory for fast CPU data processing and operation. The options are **Uncached**, **Write Through**, **Write Protect**, and **Write Back**.

Cache Extended Memory

If enabled, this feature will allow the data stored in the extended memory area to be cached (written) into a buffer, a storage area in Static DROM (SDROM) or written into L1, L2, L3 cache inside the CPU to speed up CPU operations. Select **Uncached** to disable this function. Select **Write Through** to allow data to be cached into the buffer and written into the system memory at the same time. Select **Write Protect** to prevent data from being written into the system memory area above 1MB. Select **Write Back** to allow the CPU to write data back directly from the buffer without writing data to the System Memory for fast CPU data processing and operation. The options are **Uncached**, **Write Through**, **Write Protect**, and **Write Back**.

Discrete MTRR Allocation

If enabled, MTRRs (-Memory Type Range Registers) are configured as distinct, separate units and cannot be overlapped. If enabled, the user can achieve better graphic effects when using a Linux graphic driver that requires the write-combining configuration with 4GB or more memory. The options are **Enabled** and **Disabled**.

►PCI Configuration

Access the submenu to make changes to the following settings for PCI devices.

Onboard GLAN1/Onboard GLAN2 (Gigabit- LAN) OPROM Configure

Enabling this option provides the capability to boot from GLAN. The options are **Disabled** and **Enabled**.

Onboard Storage OPROM Configure (Available if an onboard MASS Storage Controller is detected.)

Select **Enable** to allow the user to boot from a onboard mass storage device. The options are **Enabled** and **Disabled**.

Default Primary Video Adapter

This feature allows the user to specify which video adapter to be used as the default primary video adapter--the onboard video adapter or others. The options are **Other** and **Onboard Video**.

Emulated IRQ Solutions

When Enabled, the Emulated IRQ Scheme will allow PCI devices to run on legacy operating systems that use the MSI mechanism to generate INTX compatible interrupts. The options are **Disabled** and **Enabled**.

PCI-Exp. I/O Performance

Some add-on cards perform faster with the coalesce feature, which limits the payload size to 128 Bytes; while others perform better with a payload size of 256 Bytes, which inhibits the coalesce feature. Please refer to your add-on card user guide for the desired setting. The options are **Payload (256 Bytes)** and **Coalesce Enabled (128 Bytes)**.

PCI Parity Error Forwarding

The feature allows SERR and PERR errors detected in the PCI slots to be sent (forwarded) to the BIOS DMI Event Log for the user to review. The options are **Enabled** and **Disabled**.

ROM Scan Ordering

This feature allows the user to decide which Option ROM to be activated first. The options are **Onboard first** and **Add-On first**.

PCI Fast Delayed Transaction

Enable this function to improve DMA data transfer rate for a PCI 32-bit multimedia card. The options are **Enable** and **Disabled**.

Reset Configuration Data

If set to Yes, this setting clears the Extended System Configuration Data- (ESCD) area. The options are **Yes** and **No**.

Frequency for PCI-X#1/Mass (Mass Storage)

This option allows the user to change the bus frequency for the devices installed in the slot indicated. The options are **Auto**, **PCI 33 MHz**, **PCI 66 MHz**, **PCI-X 66 MHz**, **PCI-X 100 MHz**, and **PCI-X 133 MHz**.

Frequency for PCI-X#2-#3

This option allows the user to change the bus frequency for the devices installed in the slot indicated. The options are **Auto**, **PCI 33 MHz**, **PCI 66 MHz**, **PCI-X 66 MHz**, **PCI-X 100 MHz**, and **PCI-X 133 MHz**.

► **Slot#1 PCI-X100 MHz ZCR, Slot#2 PCI-X 133MHz, Slot#3 PCI-X 133MHz, Slot#4 PCI-E x4, Slot#5 PCI-33MHz and Slot#6 PCI-E x16**

Access the submenu for each of the settings above to make changes to the following:

Option ROM Scan

When enabled, this setting will initialize the device expansion ROM. The options are **Enabled** and Disabled.

Enable Master

This setting allows you to enable the selected device as the PCI bus master. The options are **Enabled** and Disabled.

Latency Timer

This setting allows you to set the clock rate for Bus Master. A high-priority, high-throughput device may benefit from a greater clock rate. The options are **Default**, 0020h, 0040h, 0060h, 0080h, 00A0h, 00C0h, and 00E0h. For Unix, Novell and other Operating Systems, please select the option: other. If a drive fails after the installation of a new software, you might want to change this setting and try again. A different OS requires a different Bus Master clock rate.

Large Disk Access Mode

This setting determines the size of a hard drive to be accessed by the user. The options are **DOS** or Other (for Unix, Novelle NetWare and other operating systems).

► Advanced Chipset Control

Access the submenu to make changes to the following settings.



Warning: Take Caution when changing the Advanced settings. Incorrect values entered may cause the system to malfunction. Also, a very high DRAM frequency or incorrect DRAM timing may cause system instability. When this occurs, revert the setting to the default setting.

SERR Signal Condition

This setting specifies the ECC Error conditions that an SERR# is to be asserted. The options are None, **Single Bit**, Multiple Bit, and Both.

4GB PCI Hole Granularity

This feature allows you to select the granularity of PCI holes for the PCI slots. If MTRRs are not enough, this option may be used to reduce MTRR occupation. The options are: **256 MB**, 512 MB, 1GB and 2GB.

Memory Branch Mode

This option determines how the two memory branches operate. System address space can either be interleaved between the two branches or Sequential from one branch to another. Mirror mode allows data correction by maintaining two copies of data in two branches. Single Channel 0 allows a single DIMM population during system manufacturing. The options are **Interleave**, Sequential, Mirroring, and Single Channel 0.

Branch 0 Rank Sparing/Branch 1 Rank Sparing

Select **enable** to enable the function of memory sparing for Memory Bus Branch 0 or Branch 1. The options are Enabled and **Disabled**.

Branch 0 Rank Interleaving/Branch 1 Rank Interleaving

Select enable to enable Interleaved Memory for Memory Bus Branch 0 Rank or Branch 1 Rank. The options for Memory Interleaving are 1:1, 2:1 and **4:1**.

Enhanced x8 Detection

Select **Enabled** to enable Enhanced x8 DRAM UC Error Detection. The options are Disabled and **Enabled**.

High Temperature DRAM Operation

When set to Enabled, the BIOS will refer to the SPD table to set the maximum DRAM temperature. If disabled, the BIOS will set the maximum DRAM temperature based on a predefined value. The options are Enabled and **Disabled**.

AMB Thermal Sensor

Select Enabled to enable the thermal sensor embedded in the Advanced Memory Buffer on a fully buffered memory module for thermal monitoring. The options are **Disabled** and Enabled.

Thermal Throttle

Select Enabled to enable closed-loop thermal throttling on a fully buffered (FBD) memory module. In the closed-loop thermal environment, thermal throttling will be activated when the temperature of the FBD DIMM module exceeds a predefined threshold. The options are Enabled and **Disabled**.

Global Activation Throttle

Select Enabled to enable the function of open-loop global thermal throttling on the fully buffered (FBD) memory modules and allow global thermal throttling to become active when the number of activate control exceeds a predefined number. The options are Enabled and **Disabled**.

Snoop Filter

Select **Enabled** to eliminate snoop traffic to the graphics port to greatly improve system performance when running graphics intensive applications. The options are **Enabled** and Disabled.

Crystal Beach Features

Select **Enabled** to use the Intel I/O AT (Acceleration Technology) to accelerate the performance of TOE devices. (Note: A TOE device is a specialized, dedicated processor that is installed on an add-on card or a network card to handle some or all packet processing of this add-on card. For this motherboard, the TOE device is built inside the ESB 2 South Bridge chip.) The options are **Enabled** and Disabled.

HD (High Definition) Audio Controller

This option allows the user to enable or disable the onboard HD Audio Controller. Select **Auto** to allow the HD Audio Controller to be automatically enabled when detected by the BIOS. The options are Disabled and **Auto**.

Route Port 80h Cycles to

This feature allows the user to decide which bus to send debug information to. The options are Disabled, **PCI** and LPC.

Clock Spectrum Feature

If Enabled, the BIOS will monitor the level of Electromagnetic Interference caused by the components and will attempt to decrease the interference whenever needed. The options are Enabled and **Disabled**.

High Precision Event Time

Select Yes to activate the High Precision Event Timer (HPET), which is capable of producing periodic interrupts at a much higher frequency than a Real-time Clock (RTC) can in synchronizing multimedia streams, providing smooth playback and reducing the dependency on other timestamp calculation devices, such as an x86 RDTSC Instruction embedded in a CPU. The High Precision Event Timer is used to replace the 8254 Programmable Interval Timer. The options for this feature are Yes and **No**.

USB Function

Select Enabled to enable the function of USB devices specified. The settings are **Enabled** and Disabled.

Legacy USB Support

This setting allows you to enable support for Legacy USB devices. The settings are **Enabled** and Disabled.

► Advanced Processor Options

Access the submenu to make changes to the following settings.

CPU Speed

This is a display that indicates the speed of the installed processor.

Frequency Ratio (Available when supported by the CPU.)

The feature allows the user to set the internal frequency multiplier for the CPU. The options are: **Default**, x12, x13, x14, x15, x16, x17 and x18. (**Note:** The settings can be different, depending on the CPU speed.)

Core-Multi-Processing (Available when supported by the CPU.)

Set to Enabled to use a processor's Second Core and beyond. (Please refer to Intel's web site for more information.) The options are Disabled and **Enabled**.

Machine Checking (Available when supported by the CPU.)

Set to Enabled to activate the function of Machine Checking and allow the CPU to detect and report hardware (machine) errors via a set of model-specific registers (MSRs). The options are Disabled and **Enabled**.

Thermal Management 2 (Available when supported by the CPU.)

Set to **Enabled** to use Thermal Management 2 (TM2) which will lower CPU voltage and frequency when the CPU temperature reaches a predefined overheat threshold. Set to Disabled to use Thermal Manager 1 (TM1), allowing CPU clocking to be regulated via CPU Internal Clock modulation when the CPU temperature reaches the overheat threshold.

C1 Enhanced Mode (Available when supported by the CPU.)

Set to Enabled to enable Enhanced Halt State to lower CPU voltage/frequency to prevent overheat. The options are Enabled and **Disabled**. **Note:** please refer to Intel's web site for detailed information.

Execute Disable Bit (Available when supported by the CPU and the OS.)

Set to **Enabled** to enable Execute Disable Bit and allow the processor to classify areas in memory where an application code can execute and where it cannot, and thus preventing a worm or a virus from inserting or creating a flood of codes to overwhelm the processor or damage the system during an attack. (**Note:** this feature is available when your OS and your CPU support the function of Execute Disable Bit.) The options are Disabled and **Enabled**. **Note:** For more information regarding hardware/software support for this function, please refer to Intel's and Microsoft's web sites.

Adjacent Cache Line Prefetch (Available when supported by the CPU.)

The CPU fetches the cache line for 64 bytes if this option is set to Disabled. The CPU fetches both cache lines for 128 bytes as comprised if Enabled. The options are Disabled and **Enabled**.

Hardware Prefetch (Available when supported by the CPU.)

Set to this option to **enabled** to enable the hardware components that are used in conjunction with software programs to prefetch data in order to shorten execution cycles and maximize data processing efficiency. The options are Disabled and **Enabled**.

Direct Cache Access (Available when supported by the CPU.)

Set to Enable to route inbound network IO traffic directly into processor caches to reduce memory latency and improve network performance. The options are **Disabled** and Enabled.

DCA Delay Clocks(Available when supported by the CPU.)

This feature allows the user to set the clock delay setting from snoop to prefetch for Direct Cache Access. Select a setting from 8 (bus cycles) to 120 (bus cycles) (in 8-cycle increment). The default setting is **32 (bus cycles)**.

Intel <R> Virtualization Technology (Available when supported by the CPU.)

Select Enabled to use the feature of Virtualization Technology to allow one platform to run multiple operating systems and applications in independent partitions, creating multiple "virtual" systems in one physical computer. The options are Enabled and **Disabled**. **Note:** If there is any change to this setting, you will need to power off and restart the system for the change to take effect. Please refer to Intel's web site for detailed information.

Intel EIST Support (Available when supported by the CPU.)

Select Enabled to use the Enhanced Intel SpeedStep Technology and allows the system to automatically adjust processor voltage and core frequency in an effort to reduce power consumption and heat dissipation. The options are Enabled and **Disabled**. **Please refer to Intel's web site for detailed information.**

► I/O Device Configuration

Access the submenu to make changes to the following settings.

KBC Clock Input

This setting allows you to select clock frequency for KBC. The options are 6MHz, 8MHz, **12MHz**, and 16MHz.

Serial Port A

This setting allows you to assign control of Serial Port A. The options are **Enabled** (user defined), Disabled, and Auto (BIOS- or OS- controlled).

Base I/O Address

This setting allows you to select the base I/O address for Serial Port A. The options are **3F8**, 2F8, 3E8, and 2E8.

Interrupt

This setting allows you to select the IRQ (interrupt request) for Serial Port A. The options are IRQ3 and **IRQ4**.

Serial Port B (Not for external use, used for IPMI only)

This setting allows you to assign control of Serial Port B. The options are **Enabled** (user defined), Disabled, Auto (BIOS controlled) and OS Controlled.

Mode

This setting allows you to set the type of device that will be connected to Serial Port B. The options are **Normal** and IR (for an infrared device).

Base I/O Address

This setting allows you to select the base I/O address for Serial Port B. The options are 3F8, **2F8**, 3E8 and 2E8.

Interrupt

This setting allows you to select the IRQ (interrupt request) for Serial Port B. The options are **IRQ3** and IRQ4.

Parallel Port

This setting allows you to assign control of the parallel port. The options are **Enabled** (user defined), Disabled and Auto (BIOS-or OS- controlled).

Base I/O Address

Select the base I/O address for the parallel port. The options are **378**, 278 and 3BC.

Interrupt

This setting allows you to select the IRQ (interrupt request) for the parallel port. The options are IRQ5 and **IRQ7**.

Mode

This feature allows you to specify the parallel port mode. The options are Output only, Bi-Directional, EPP and **ECP**.

DMA Channel

This item allows you to specify the DMA channel for the parallel port. The options are DMA1 and **DMA3**.

Floppy Disk Controller

This setting allows you to assign control of the floppy disk controller. The options are **Enabled** (user defined), Disabled, and Auto (BIOS and OS controlled).

Base I/O Address

This setting allows you to select the base I/O address for the parallel port. The options are **Primary** and Secondary.

► DMI Event Logging

Access the submenu to make changes to the following settings.

Event Log Validity

This is a display to inform you of the event log validity. It is not a setting.

Event Log Capacity

This is a display to inform you of the event log capacity. It is not a setting.

View DMI Event Log

Highlight this item and press <Enter> to view the contents of the event log.

Event Logging

This setting allows you to **Enable** or Disable event logging.

ECC Event Logging

This setting allows you to **Enable** or Disable ECC event logging.

Mark DMI Events as Read

Highlight this item and press <Enter> to mark the DMI events as read.

Clear All DMI Event Logs

Select Yes and press <Enter> to clear all DMI event logs. The options are Yes and **No**.

► Console Redirection

Access the submenu to make changes to the following settings.

COM Port Address

This item allows you to specify which COM port to direct the remote console to: Onboard COM A or Onboard COM B. This setting can also be **Disabled**.

BAUD Rate

This item allows you to set the BAUD rate for Console Redirection. The options are 300, 1200, 2400, 9600, **19.2K**, 38.4K, 57.6K, and 115.2K.

Console Type

This item allows you to choose the console redirection type. The options are VT100, VT100,8bit, PC-ANSI, 7bit, **PC ANSI**, VT100+, and VT-UTF8.

Flow Control

This item allows you to set the flow control for the console redirection. The options are: None, XON/XOFF, and **CTS/RTS**.

Console Connection

This item allows you to decide how the console redirection is to be connected: either **Direct** or Via Modem.

Continue CR after POST

This item allows you to decide whether you want to continue with console redirection after POST routines. The options are On and **Off**.

► Hardware Monitor Logic

Note: The Phoenix BIOS will automatically detect the type of CPU(s) and hardware monitoring chip used on the motherboard and will display the Hardware Monitoring Screen accordingly. Your screen may look differently from the one shown below.

CPU Temperature Threshold

This option allows the user to set a CPU temperature threshold that will activate the alarm system when the CPU temperature reaches this pre-set temperature threshold. The options are 70°C, **75°C**, 80°C and 85°C.

Highlight this and hit <Enter> to see the status for each of the following items:

CPU1 Temperature/CPU1 Second Core

CPU2 Temperature/CPU2 Second Core

PECI Agent 1 Temperature/PECI Agent 2 Temperature

PECI Agent 3 Temperature/PECI Agent 4 Temperature

System Temperature

Fan1-Fan8 Speeds: If the feature of Auto Fan Control is enabled, the BIOS will automatically display the status of the fans indicated in this item.

Fan Speed Control Modes

This feature allows the user to decide how the system controls the speeds of the onboard fans. The CPU temperature and the fan speed are correlative. When the CPU on-die temperature increases, the fan speed will also increase, and vice versa. If the option is set to 3-pin fan, the fan speed is controlled by voltage. If the option is set to 4-pin, the fan speed will be controlled by Pulse Width Modulation (PWM). Select 3-pin if your chassis came with 3-pin fan headers. Select 4-pin if your chassis came with 4-pin fan headers. Select Workstation if your system is used as a Workstation. Select Server if your system is used as a Server. Select Disable to disable the fan speed control function and allow the onboard fans to constantly run at full speed (12V). The Options are: **1. Full Speed@12V (Disable)**, 2. Optimized Server w/3-pin, 3. Optimized Workstation w/3-pin, 4. Optimized Server w/4-pin, and 5. Optimized Server w/4-pin.

Voltage Monitoring

The following items will be monitored and displayed:

Vcore A/Vcore B/-12V/P1V5/+3.3V/+12V/5Vsb/5VDD/P_VTT/Vbat

Note: In the Windows OS environment, the Supero Doctor III settings take precedence over the BIOS settings. When first installed, Supero Doctor III adopts the temperature threshold settings previously set in the BIOS. Any subsequent changes to these thresholds must be made within Supero Doctor, since the SD III settings override the BIOS settings. For the Windows OS to adopt the BIOS temperature threshold settings, please change the SDIII settings to be the same as those set in the BIOS.

► IPMI (The option is available only when an IPMI card is installed in the system.)

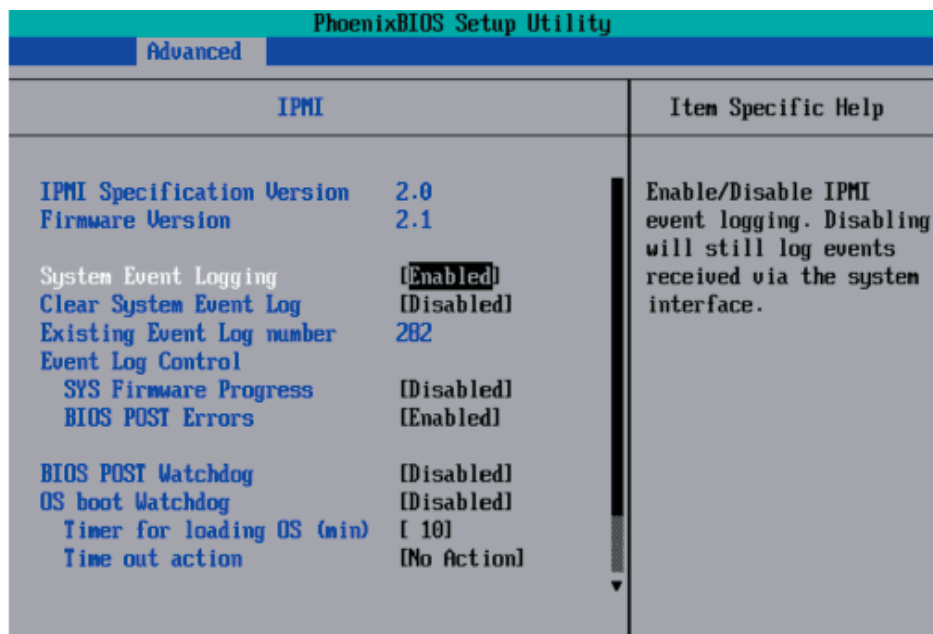

IPMI Specification Version: This item displays the current IPMI Version.

Firmware Version: This item displays the current Firmware Version.

System Event Logging

Select Enabled to enable IPMI Event Logging. When this function is set to Disabled, the system will continue to log events received via system interface. The options are **Enabled** and **Disabled**.

Clear System Event Logging

Enabling this function to force the BIOS to clear the system event logs during the next cold boot. The options are **Enabled** and **Disabled**.

Existing Event Log Number

This item displays the number of the existing event log.

Event Log Control

System Firmware Progress

Enabling this function to log POST progress. The options are **Enabled** and **Disabled**.

BIOS POST Errors

Enabling this function to log POST errors. The options are **Enabled** and **Disabled**.

BIOS POST Watch Dog

Set to **Enabled** to enable POST Watch Dog. The options are **Enabled** and **Disabled**.

OS Boot Watch Dog

Set to Enabled to enable OS Boot Watch Dog. The options are Enabled and Disabled.

Timer for Loading OS (Minutes)

This feature allows the user to set the time value (in minutes) for the previous item: OS Boot Watch Dog by keying-in a desired number in the blank. The default setting is 10 (minutes.) (Please ignore this option when OS Boot Watch Dog is set to Disabled.)

Time Out Option

This feature allows the user to determine what action to take in an event of a system boot failure. The options are **No Action**, Reset, Power Off and Power Cycles.

► System Event Log/System Event Log (List Mode)

These options display the System Event (SEL) Log and System Event (SEL) Log in List Mode. Items include: SEL (System Event Log) Entry Number, SEL Record ID, SEL Record Type, Time Stamp, Generator ID, SEL Message Revision, Sensor Type, Sensor Number, SEL Event Type, Event Description, and SEL Event Data.

```

System Event Log

SEL Entry Number = 1
SEL Record ID = 0001
SEL Record Type = 02 - System Event Record
Timestamp = 02.10.2006 17:11:23
Generator Id = 20 00
SEL Message Rev = 04
Sensor Type = 02 - Voltage
Sensor Number = 0A - -12V
SEL Event Type = 01 - Threshold
Event Description = Lower Non-critical Going Low, Assertion
SEL Event Data = 50 06 0E

F1 Help ↑↓ Select Item -/+ Change Values F9 Setup Defaults
Esc Exit + Select Menu Enter Select ► Sub-Menu F10 Save and Exit

```

► **Realtime Sensor Data**

This feature display information from motherboard sensors, such as temperatures, fan speeds and voltages of various components.

Realtime Sensor Data					
Sensor Type	Sensor Name	Sensor Data	Sensor Units	Lower Limit	Upper Limit
Temp					
	CPU1 CoreA	48.00	degrees C	0.00	75.00
	CPU1 CoreB	54.00	degrees C	0.00	75.00
	CPU2 CoreA	47.00	degrees C	0.00	75.00
	CPU2 CoreB	46.00	degrees C	0.00	75.00
	System	44.00	degrees C	0.00	75.00
Voltage					
	CPU1 Core	1.13	Volts	0.97	1.47
	CPU2 Core	1.16	Volts	0.97	1.47
	3.3V	3.30	Volts	2.95	3.62

F1	Help	↑	Select Item	-/+	Change Values	F9	Setup Defaults
Esc	Exit	+	Select Menu	Enter	Select ▶ Sub-Menu	F10	Save and Exit

4-5 Security Settings

Choose Security from the Phoenix BIOS Setup Utility main menu with the arrow keys. You should see the following display. Security setting options are displayed by highlighting the setting using the arrow keys and pressing <Enter>. All Security BIOS settings are described in this section.

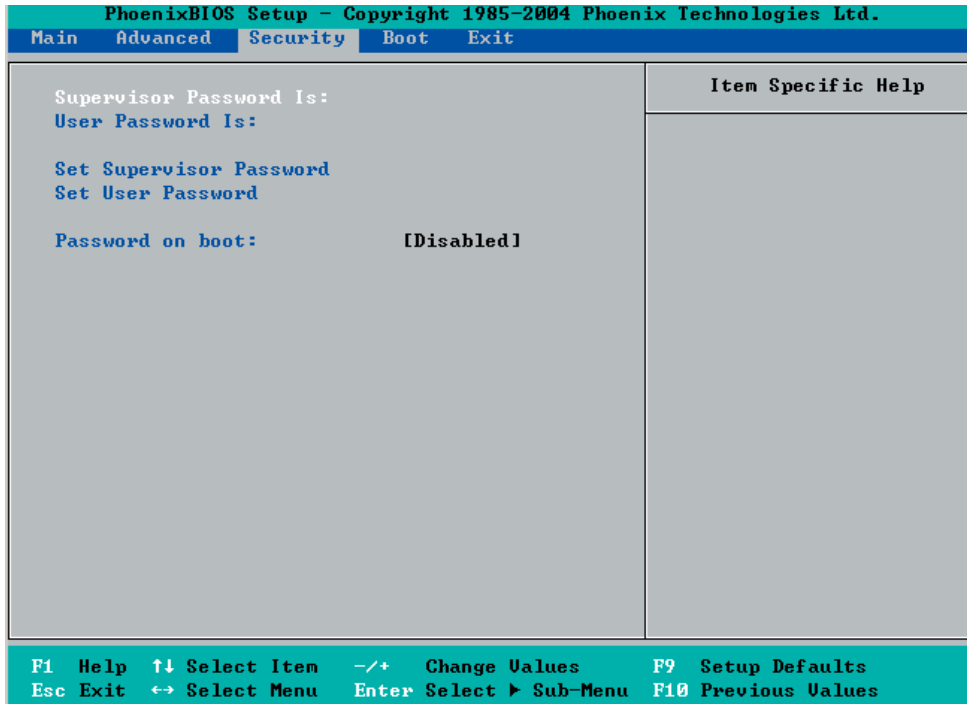

Supervisor Password Is:

This feature indicates if a supervisor password has been entered to the system. Clear means such a password has not been used, and Set means a supervisor password has been entered.

User Password Is:

This feature indicates if a user password has been entered to the system. Clear means such a password has not been used, and Set means a user password has been entered.

Set Supervisor Password

When this item is highlighted, hit the <Enter> key. When prompted, type the Supervisor's password in the dialogue box to set or to change supervisor's password to allow access to the BIOS.

Set User Password

When the item is highlighted, hit the <Enter> key. When prompted, type the user's password in the dialogue box to set or to change the user's password, which will allow access to the system at boot-up.

Password on Boot

This setting allows you to determine if a password is required for a user to enter the system at bootup. The options are Enabled (password required) and **Disabled** (password not required).

4-6 Boot Settings

Choose Boot from the Phoenix BIOS Setup Utility main menu with the arrow keys. You should see the following display. See details on how to change the order and specs of boot devices in the Item Specific Help window. All Boot BIOS settings are described in this section.

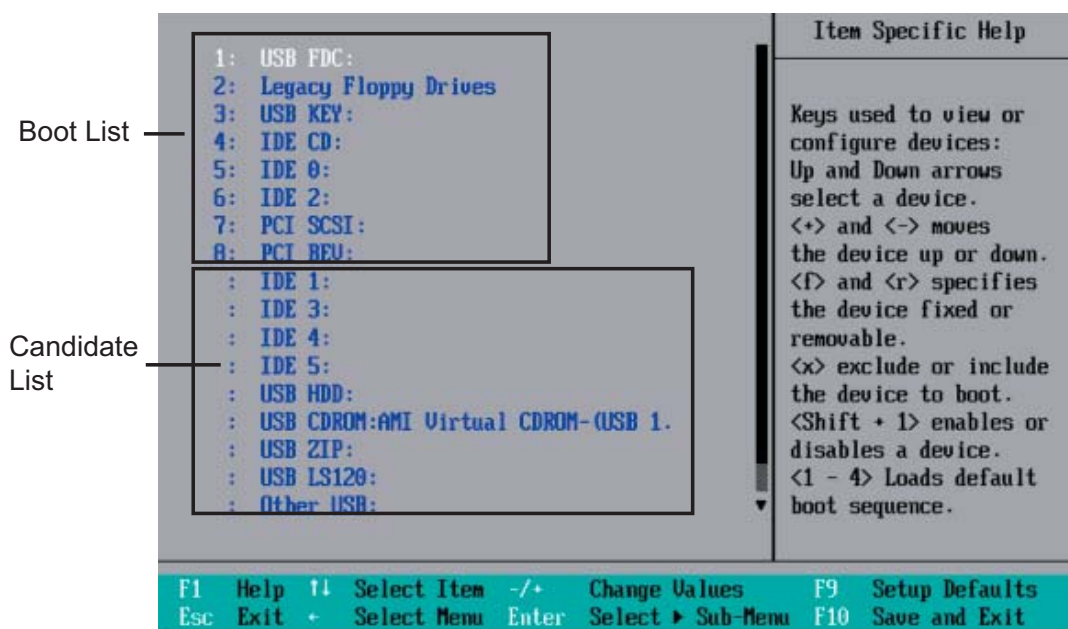

Boot Priority Order/Excluded from Boot Orders

The items included in the boot list section are bootable devices listed in the sequence of boot order as specified. The items included in the candidate list are currently not bootable. Use the <+> key or the <-> key to move the device up or down. Use the <f> key or the <r> key to specify the type of USB device, either fixed or removable. You can select one item from the boot list and hit the <x> key to remove it from the list of bootable devices (to make its resource available for other bootable devices). Conversely, you can select an item from the candidate list and hit the <x> key to remove it from the candidate list and put it in the boot list to make it bootable. See details on how to change the priority of boot order of devices in the "Item Specific Help" window.

4-7 Exit

Choose Exit from the Phoenix BIOS Setup Utility main menu with the arrow keys. You should see the following display. All Exit BIOS settings are described in this section.

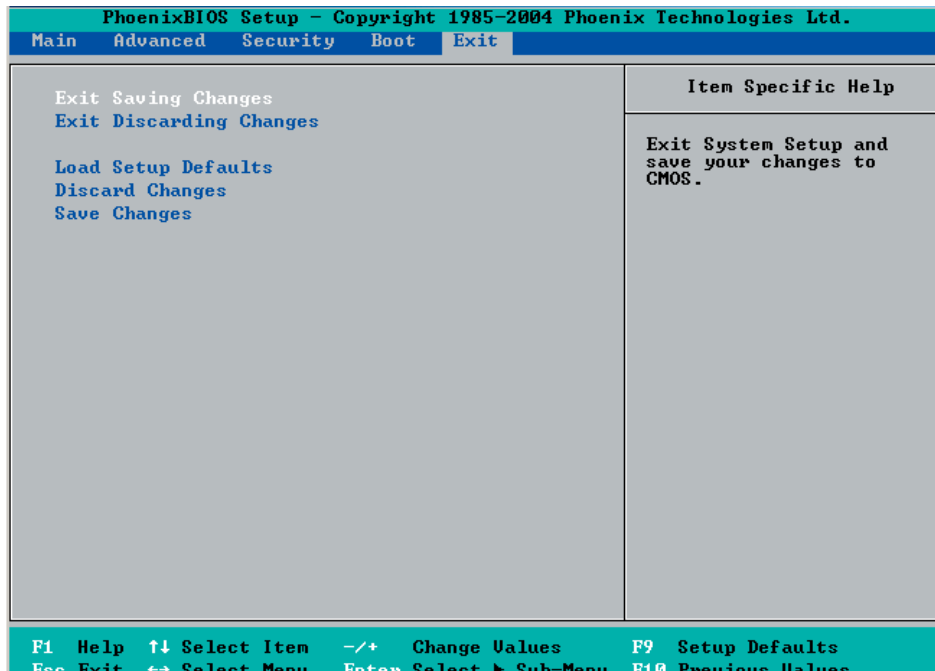

Exit Saving Changes

Highlight this item and hit <Enter> to save any changes you've made and to exit the BIOS Setup utility.

Exit Discarding Changes

Highlight this item and hit <Enter> to exit the BIOS Setup utility without saving any changes you may have made.

Load Setup Defaults

Highlight this item and hit <Enter> to load the default settings for all items in the BIOS Setup. These are the safest settings to use.

Discard Changes

Highlight this item and hit <Enter> to discard (cancel) any changes you've made. You will remain in the Setup utility.

Save Changes

Highlight this item and hit <Enter> to save any changes you've made. You will remain in the Setup utility.

Notes

Appendix A

BIOS POST Messages

During the Power-On Self-Test (POST), the BIOS will check for problems. If a problem is found, the BIOS will activate an alarm or display a message. The following is a list of such BIOS messages.

Failure Fixed Disk

Fixed disk is not working or not configured properly. Check to see if fixed disk is attached properly. Run Setup. Find out if the fixed-disk type is correctly identified.

Stuck key

Stuck key on keyboard.

Keyboard error

Keyboard not working.

Keyboard Controller Failed

Keyboard controller failed test. May require replacing keyboard controller.

Keyboard locked - Unlock key switch

Unlock the system to proceed.

Monitor type does not match CMOS - Run SETUP

Monitor type not correctly identified in Setup

Shadow Ram Failed at offset: nnnn

Shadow RAM failed at offset **nnnn** of the 64k block at which the error was detected.

System RAM Failed at offset: nnnn

System RAM failed at offset **nnnn** of in the 64k block at which the error was detected.

Extended RAM Failed at offset: nnnn Extended memory not working or not configured properly at offset **nnnn**.

System battery is dead - Replace and run SETUP

The CMOS clock battery indicator shows the battery is dead. Replace the battery and run Setup to reconfigure the system.

System CMOS checksum bad - Default configuration used

System CMOS has been corrupted or modified incorrectly, perhaps by an application program that changes data stored in CMOS. The BIOS installed Default Setup Values. If you do not want these values, enter Setup and enter your own values. If the error persists, check the system battery or contact your dealer.

System timer error

The timer test failed. Requires repair of system board.

Real time clock error

Real-Time Clock fails BIOS hardware test. May require board repair.

Check date and time settings

BIOS found date or time out of range and reset the Real-Time Clock. May require setting legal date (1991-2099).

Previous boot incomplete - Default configuration used

Previous POST did not complete successfully. POST loads default values and offers to run Setup. If the failure was caused by incorrect values and they are not corrected, the next boot will likely fail. On systems with control of **wait states**, improper Setup settings can also terminate POST and cause this error on the next boot. Run Setup and verify that the waitstate configuration is correct. This error is cleared the next time the system is booted.

Memory Size found by POST differed from CMOS

Memory size found by POST differed from CMOS.

Diskette drive A error

Diskette drive B error

Drive A: or B: is present but fails the BIOS POST diskette tests. Check to see that the drive is defined with the proper diskette type in Setup and that the diskette drive is attached correctly.

Incorrect Drive A type - run SETUP

Type of floppy drive A: not correctly identified in Setup.

Incorrect Drive B type - run SETUP

Type of floppy drive B: not correctly identified in Setup.

System cache error - Cache disabled

RAM cache failed and BIOS disabled the cache. On older boards, check the cache jumpers. You may have to replace the cache. See your dealer. A disabled cache slows system performance considerably.

CPU ID:

CPU socket number for Multi-Processor error.

EISA CMOS not writeable

ServerBIOS2 test error: Cannot write to EISA CMOS.

DMA Test Failed

ServerBIOS2 test error: Cannot write to extended **DMA** (Direct Memory Access) registers.

Software NMI Failed

ServerBIOS2 test error: Cannot generate software NMI (Non-Maskable Interrupt).

Fail-Safe Timer NMI Failed

ServerBIOS2 test error: Fail-Safe Timer takes too long.

device Address Conflict

Address conflict for specified **device**.

Allocation Error for: device

Run ISA or EISA Configuration Utility to resolve resource conflict for the specified **device**.

CD ROM Drive

CD ROM Drive identified.

Entering SETUP ...

Starting Setup program

Failing Bits: nnnn

The hex number **nnnn** is a map of the bits at the RAM address which failed the memory test. Each 1 (one) in the map indicates a failed bit. See errors 230, 231, or 232 above for offset address of the failure in System, Extended, or Shadow memory.

Fixed Disk n

Fixed disk **n** (0-3) identified.

Invalid System Configuration Data

Problem with NVRAM (CMOS) data.

I/O device IRQ conflict

I/O device IRQ conflict error.

PS/2 Mouse Boot Summary Screen:

PS/2 Mouse installed.

nnnn kB Extended RAM Passed

Where **nnnn** is the amount of RAM in kilobytes successfully tested.

nnnn Cache SRAM Passed

Where **nnnn** is the amount of system cache in kilobytes successfully tested.

nnnn kB Shadow RAM Passed

Where **nnnn** is the amount of shadow RAM in kilobytes successfully tested.

nnnn kB System RAM Passed

Where **nnnn** is the amount of system RAM in kilobytes successfully tested.

One or more I2O Block Storage Devices were excluded from the Setup Boot Menu

There was not enough room in the IPL table to display all installed I2O block-storage devices.

Operating system not found

Operating system cannot be located on either drive A: or drive C:. Enter Setup and see if fixed disk and drive A: are properly identified.

Parity Check 1 nnnn

Parity error found in the system bus. BIOS attempts to locate the address and display it on the screen. If it cannot locate the address, it displays **????**. Parity is a method for checking errors in binary data. A parity error indicates that some data has been corrupted.

Parity Check 2 nnnn

Parity error found in the I/O bus. BIOS attempts to locate the address and display it on the screen. If it cannot locate the address, it displays **????**.

Press <F1> to resume, <F2> to Setup, <F3> for previous

Displayed after any recoverable error message. Press <F1> to start the boot process or <F2> to enter Setup and change the settings. Press <F3> to display the previous screen (usually an initialization error of an **Option ROM**, i.e., an add-on card). Write down and follow the information shown on the screen.

Press <F2> to enter Setup

Optional message displayed during POST. Can be turned off in Setup.

PS/2 Mouse:

PS/2 mouse identified.

Run the I2O Configuration Utility

One or more unclaimed block storage devices have the Configuration Request bit set in the LCT. Run an I2O Configuration Utility (e.g. the SAC utility).

System BIOS shadowed

System BIOS copied to shadow RAM.

UMB upper limit segment address: *nnnn*

Displays the address *nnnn* of the upper limit of **Upper Memory Blocks**, indicating released segments of the BIOS which can be reclaimed by a virtual memory manager.

Video BIOS shadowed

Video BIOS successfully copied to shadow RAM.

Notes

Appendix B

POST Error Beep Codes

This section lists POST (Power On Self Test) error beep codes for the Phoenix BIOS. POST error beep codes are divided into two categories: recoverable and terminal. This section lists Beep Codes for recoverable POST errors.

Recoverable POST Error Beep Codes

When a recoverable type of error occurs during POST, BIOS will display a POST code that describes the problem. BIOS may also issue one of the following beep codes:

- 1 long and two short beeps - video configuration error
- 1 repetitive long beep - no memory detected

Notes

Appendix C

Installing the Adaptec HostRAID Utility and the Windows OS

After all the hardware has been installed, you must first configure the SAS RAID before you install the Windows Operating System and other software drivers.

C-1 The Adaptec Embedded SAS with HostRAID Controller

Note: If you do not wish to configure Adaptec SAS/SATA HostRAID functions, please go directly to Section C-2 and Appendix E for the Windows OS and Other Software Installation instructions. For Intel's ESB2 SATA HostRAID Utility, please refer to Appendix D. For more information on the SAS/SATA RAID settings, please refer to the CD that came with your motherboard.

Introduction to SATA (Serial ATA) and SAS (Serial Attached SCSI)

Serial ATA(SATA) is a physical storage interface. It uses a single cable with a minimum of four wires to create a point-to-point connection between devices. It is a serial link which supports SATA transfer rates up to 150Mbps. Because the serial cables used in Serial ATA are thinner than the traditional cables used in Parallel ATA (PATA), SATA systems provide more efficient system cooling, faster data transfer and better functionality than Parallel ATA. In addition to SATA which is supported by the Intel ESB2 South Bridge, the X7DA3+ has an Adaptec SAS (Serial Attached SCSI) 9410W Controller built in. SAS supports serial link data transfer rates up to 3Gbps. With the dynamic SAS infrastructure built in, the X7DA3+ supports both SATA and SAS, providing the user with unparalleled data storage expansion and inter-connectivity capability.

Using the Adaptec RAID Configuration Utility

The onboard SAS Controller is enabled by default. To disable it, please set Jumper JPS1 to Pins 2-3 (See Page 2-28 in Chapter 2 for details.)

When the system is detecting the SAS Controller BIOS, make sure that the 16-digit Adapter WWN address displays. If this number is not shown, you will not be able to use the controller.

Once the WWN address appears, press the <Ctrl> and <A> keys simultaneously when prompted to access the Adaptec SAS RAID BIOS. (**Note:** Use the arrow keys to highlight an item and then press <Enter> to select an option. To return to the previous menu, press <ESC>.)

A. Using the Array Configuration Utility

The Array Configuration Utility enables you to create, manage, and delete arrays from the controller's BIOS, add and delete spare drives, and initialize drives. During the system startup, press <Ctrl> and <A> simultaneously to display the main menu.

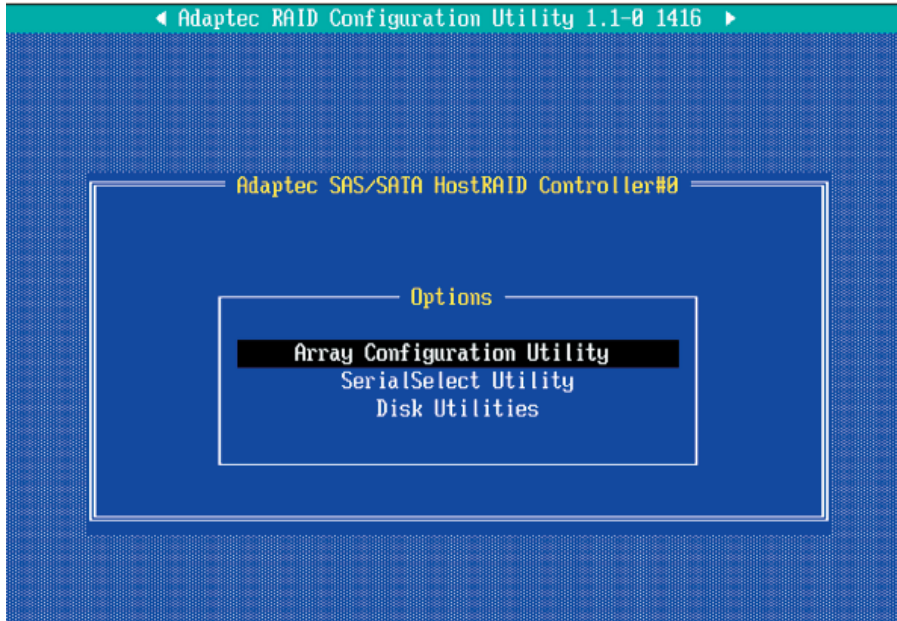

Managing Arrays

From the main menu (as shown above), select "Managing Arrays" and hit <Enter> to access the following submenu:

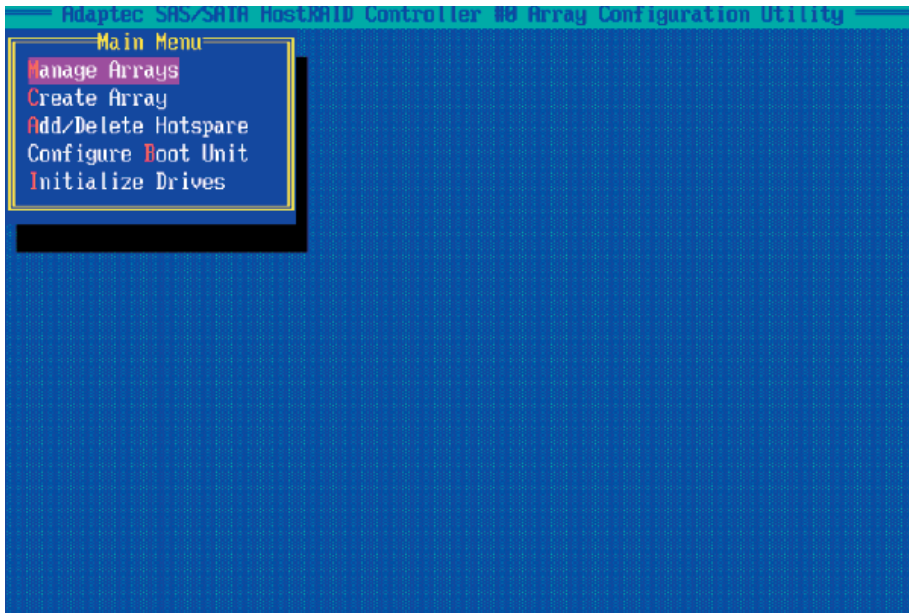

Viewing Array Properties

To view the properties of an existing array:

1. From the Array Configuration Utility menu, select Manage Arrays.
2. From the List of Arrays dialog box, select the array you want to view and press <Enter>.

The Array Properties dialog box displays, showing detailed information on the array, including the physical disks associated with the array.

3. Press <Esc> to return to the previous menu.

Deleting Arrays

Warning: To prevent accidental loss of data, be sure to back up the data on an array before you delete it. Deleted arrays cannot be restored.

To delete an existing array:

1. From the Array Configuration Utility menu, select Manage Arrays.
2. Select the array you wish to delete and press <Delete>.
3. In the Array Properties dialog box, select Delete and press <Enter>. A warning message displays:

Warning!! *Deleting the array will render array unusable. Do you want to delete the array? (Yes/No):*

RAID 1 only—the following prompt is also displayed:

Deleting the partition will result in data loss! Do you also want to delete the partition? (Yes/No):

4. Press <Yes> to delete the array or partition or <No> to return to the previous menu.
5. Press <Esc> to return to the previous menu.

Creating Arrays

Before creating arrays, make sure that the disks for the array are connected and installed in your system. Note that disks with no usable space, or disks that are uninitialized are shown in gray and cannot be used.

To create an array:

1. From the Array Configuration Utility menu, select Create Array.
2. Select the disks for the new array and press <Insert> (as the screen shown below).
(Note: To de-select any disk, highlight the disk and press <Delete>.)

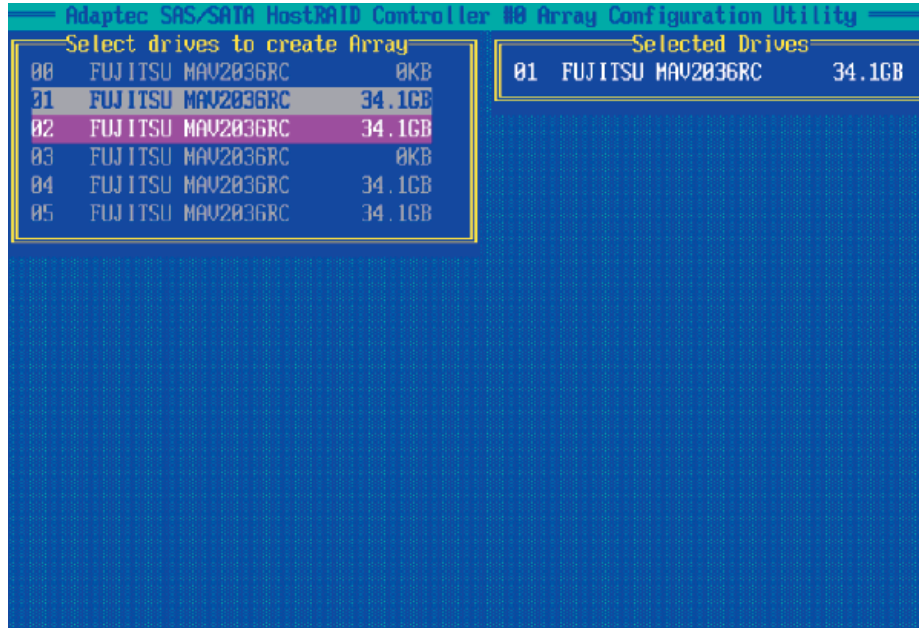

3. After both disks for the new array are selected, press <Enter>. The Array Properties menu displays (as the screen shown below).

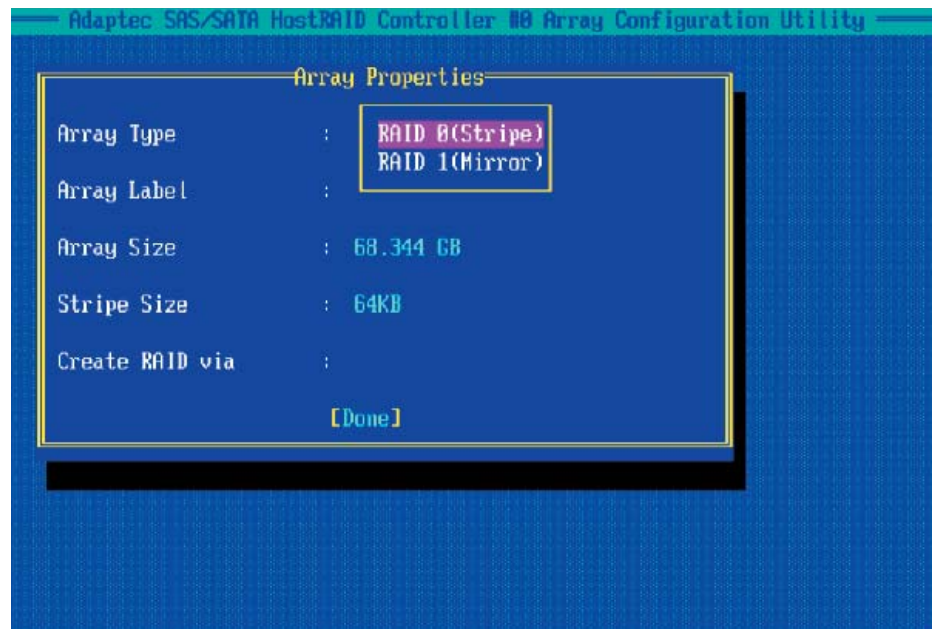

Assigning Array Properties

Once a new array is created, you can assign the properties to the array.

Caution: Once the array is created and its properties are assigned, you cannot change the array properties using the Array Configuration Utility. You will need to use the Adaptec Storage Manager to do so. (Refer to Adaptec's User's Guide in the enclosed CD.)

To assign properties to the new array:

1. In the Array Properties menu (as shown in the screen below), select an array type and press <Enter>.

Only the available array types: RAID 0, and RAID1, are displayed on the screen. (RAID 0 or RAID 1 requires two drives.)

2. Type in an label Under the item Arrays Label, and press <Enter>. (**Note:** The label shall not be more than 15 characters.)

3. For RAID 0, select the desired stripe size. (**Note:** Available stripe sizes are 16, 32, 64LK is default. Please *do not* change the default setting.)

4. You can select between the different creating methods for RAID 0 and RAID 1, using "Create RAID via" .

5. When you are finished, press Done (as shown in the previous screen).

The following table gives examples of when each is appropriate.

Raid Level	Create Via	When Appropriate
RAID 0	No Init	Creating a RAID 0 on new drives
RAID 1	Build1	Any time you wish to create a RAID 1, but especially if you have data on one drive that you wish to preserve
RAID 1	Clear	Creating a RAID 1 on new drives, or when you want to ensure that the array contains no data after creation.
RAID 1	Quick	Fastest way to create a RAID 1. Appropriate when using new drives
RAID 1	Init	

Notes:

1. Before adding a new drive to an array, back up any data contained on the new drive to prevent data loss.
2. If you stop the Build or Clear process on a RAID 1 from Array Configuration Utility, you can restart it by pressing Ctrl+R.
3. If you have used Quick Init to create a RAID 1, you might find some data incompatible after running a consistency check. This is normal.
4. You can use drives of different sizes in a RAID. However, during a build process, only the smaller drive can be selected as the source or first drive.
5. When migrating from single volume to RAID 0, migrating from a larger drive to a smaller drive is allowed. However, the destination drive must be at least half the capacity of the source drive.
6. It is not recommended that you migrate or build an array on Windows dynamic disks (volumes), as it will result in data loss.

Warning: Do not interrupt the creation of a RAID 0 using the Migrate option. If you do, you will not be able to restart, or to recover the data that was on the source drive.

Adding a Bootable Array

To make an array bootable:

1. From the Main menu, select Configure Boot Unit and press <Enter>. The following screen displays.

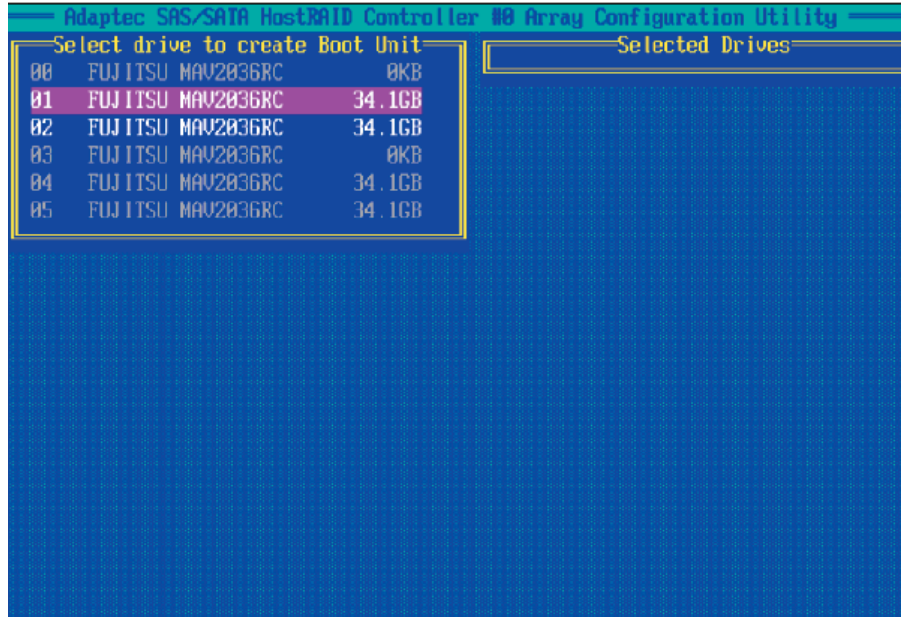

2. From the "Select Drive to Create Boot Unit" list, select the drive you wish to Configure Boot Unit and press <Insert>. The Drive you have selected appears in the right window as shown in the screen below:

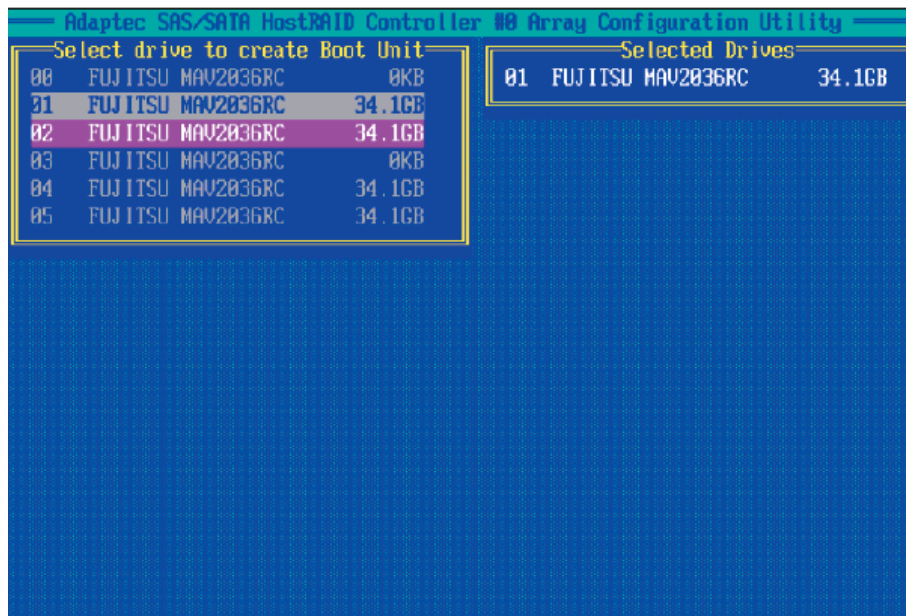

3. Select the disk drive you wish to configure as a bootable drive from the "Selected Drives" List (in the right window) and press <Enter>. The next screen appears.

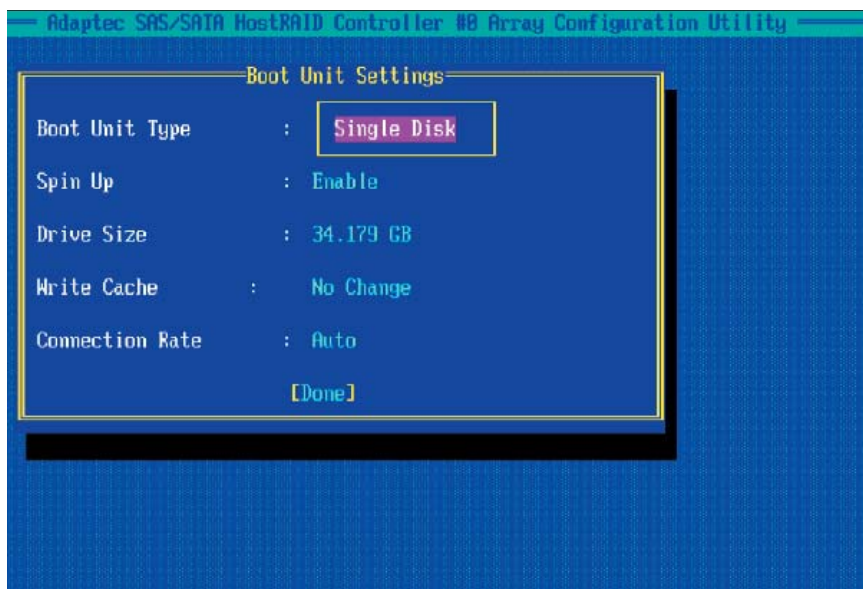

Deleting a Bootable Array

To delete a bootable array:

1. From the Main menu, select Configure Boot Unit and press <Enter>.
2. From the "Select the Boot Unit" list (in the right window), select the bootable drive you wish to delete and press <Delete>. The following screen appears:

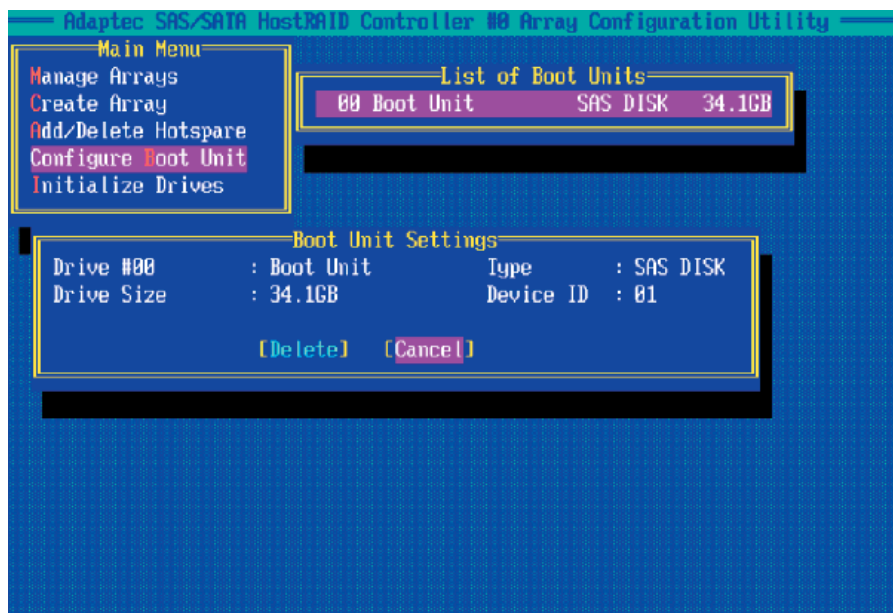

3. When the screen shown above appears, select Delete and press <Enter>.
4. Enter <Y> to delete a bootable array when the following message is displayed: "Do you want to delete the Bootable Unit? (Yes/No):" Then, the bootable array will be deleted.

Adding/Deleting Hotspares

Note: In order to rebuild a RAID (RAID 0 or RAID 1), you will need to add a new HDD as a hotspare.

1. Turn on your computer and press <Ctrl><A> as prompted to access the Adaptec RAID Configuration Utility.
2. From the ARC menu, select Array Configuration Utility.
3. From the Array Configuration Utility menu, select Add/Delete Hotspares and press <Enter>. The following screen appears:

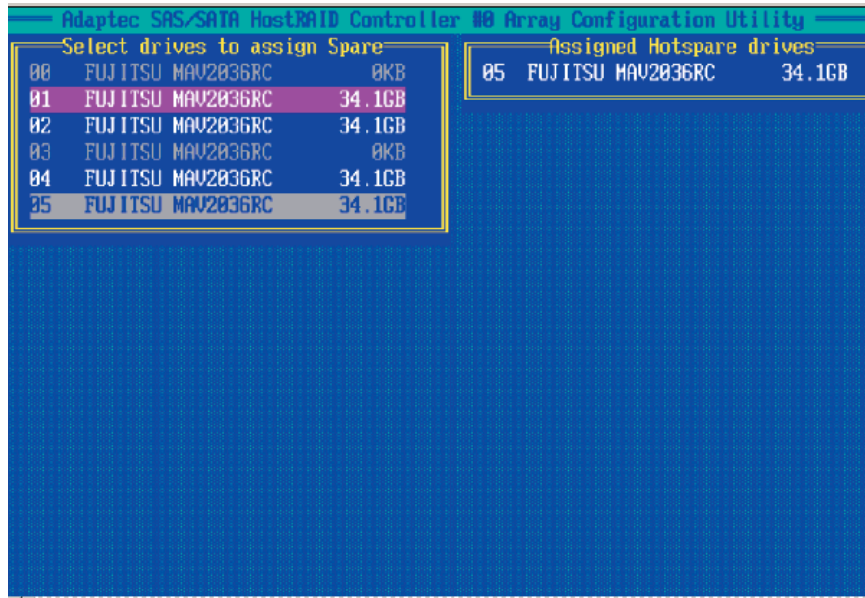

To Add a HotSpare Drive

4. Use the arrow keys to highlight and select the disk you want to designate as a Hotspare, and press <Insert> and <Enter>.
5. Press yes when the following prompt displays : "Do you want to create spare?" (Yes/No?)

The spare drive you have selected will appear in the Select Drive Menu.

To Delete a HotSpare Drive

4. From the List of "Assigned HotSpare Drives" (in the right window), select the hotspare drive you want to delete. Then, press <Delete> and <Enter>.
5. When the following prompt displays: "Do you want to Delete the Hotspare?" (Yes/No?) Press <Yes> to delete the selected hotspare.

The hotspare drive you have selected will be deleted.

Initializing Disk Drives

If an installed disk does not appear in the disk selection list for creating a new array, or if it appears grayed out, you may have to initialize it before you can use it as part of an array. Drives attached to the controller must be initialized before they can be used in an array.

Caution: Initializing a disk overwrites the partition table on the disk and makes any data on the disk inaccessible. If the drive is used in an array, you may not be able to use the array again.

Do not initialize a disk that is part of a boot array. To determine which disks are associated with a particular array, please refer to "Viewing Array Properties."

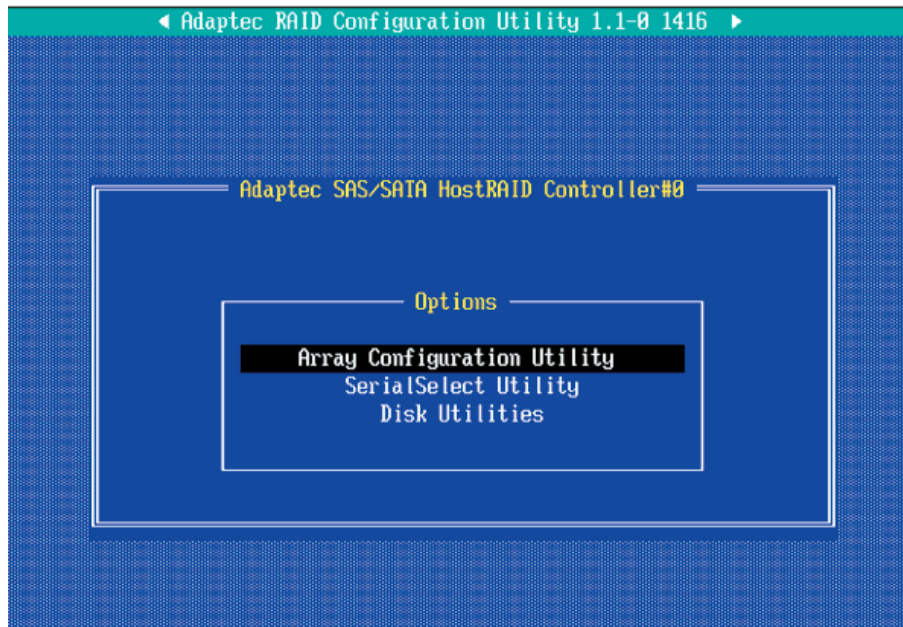

1. Turn on your computer and press <Ctrl><A> as prompted to access the Adaptec RAID Configuration Utility.
2. From the ARC menu, select Array Configuration Utility.
3. From the screen below, select Initialize Drives and press <Enter>.

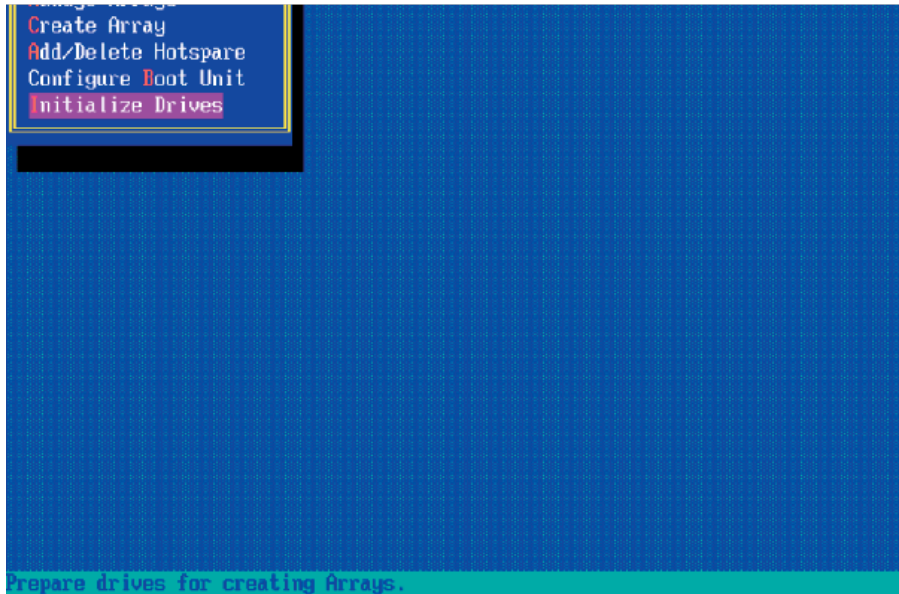

4. From the "Select drives for initialization" list (on the left screen), select the disk you wish to initialize and press <Insert>. The drive you've selected will appear on the "Selected Drives" list as show below:

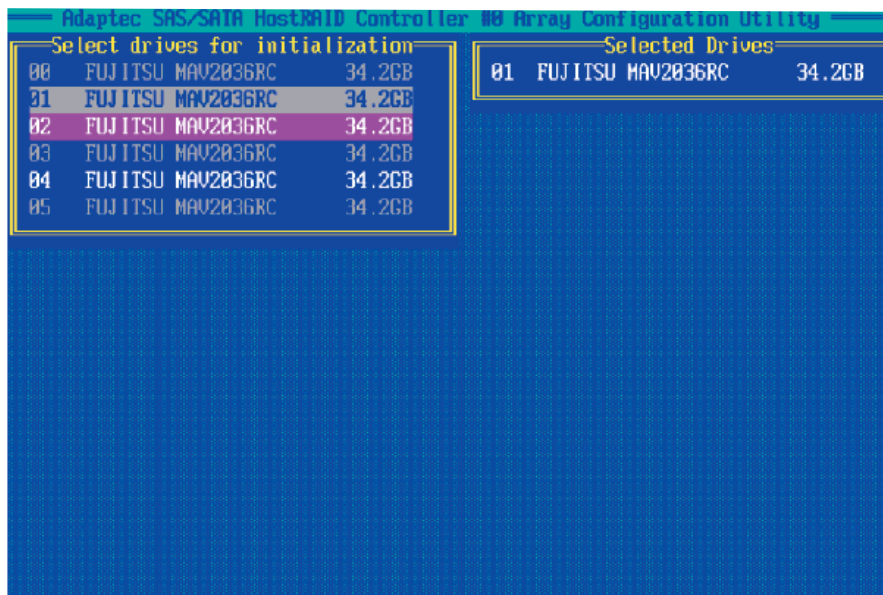

5. Repeat **Step 4** so that both drives you want to initialize are selected and press <Enter>.

6. When the following message appears, make sure that you have selected the correct drive to initialize and press <Y> to initialize the drive or press <N> to quit.

Warning: Initialization will configure the drive(s) as simple volume disk(s). Do you want to continue? (Yes/No):

Press <Yes> to continue with the Initialization.

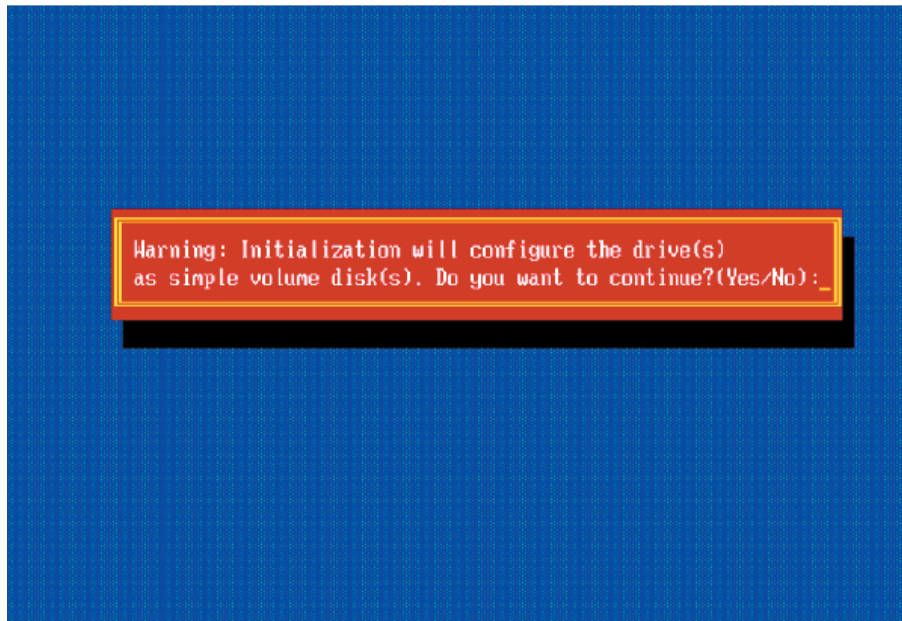

Rebuilding Arrays

Note 1: You can use Rebuilding on Fault Tolerant array (RAID 1) only.

If an array Build or Initialization process is interrupted or critical with one member missing, you must perform a Rebuild to get the array to the Optimal status. For a critical array Rebuild operation, the optimal drive is the source drive.

Note 2: If no spare array exists and a hard disk drive fails, you need to create a spare before you can rebuild an array.

To Rebuild an array:

1 From the Main Menu, select Manage Arrays (as shown in the screen below). From the List of Arrays, select the array you want to Rebuild.

2 Press <Ctrl> <R> for Array Rebuild.

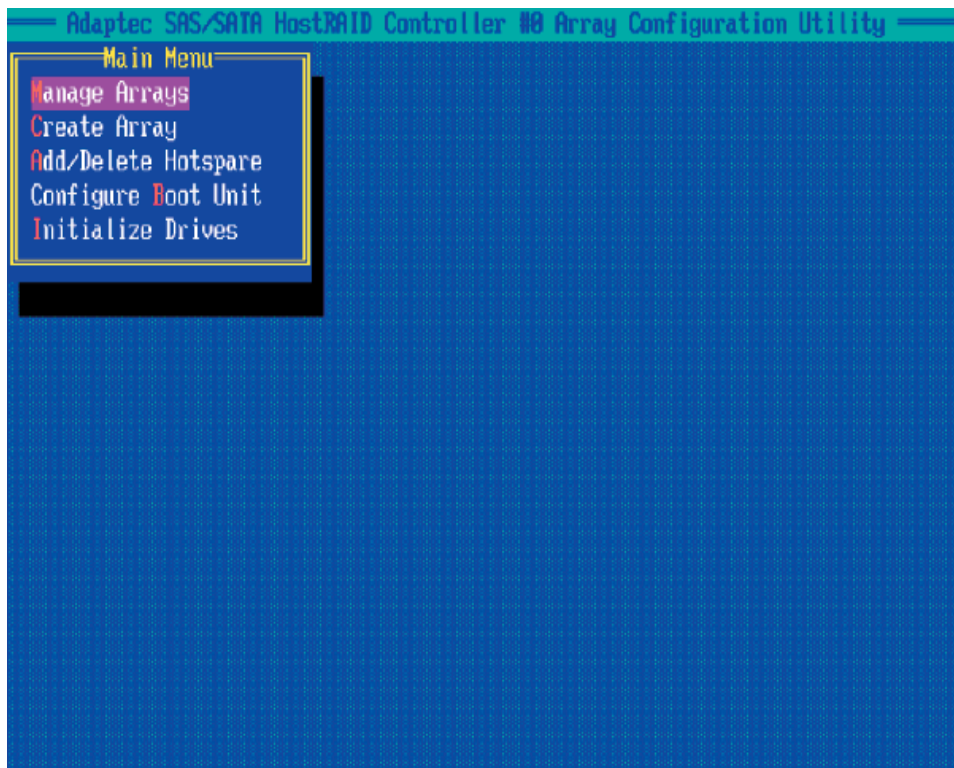

Using the SerialSelect Utility to Configure SAS Settings

The SerialSelect Utility enables you to configure SAS disk drive settings.

To access the SAS utilities:

1. Turn on your computer and press <Ctrl> <A> when prompted to access the Adaptec RAID Configuration Utility as shown in the screen below.

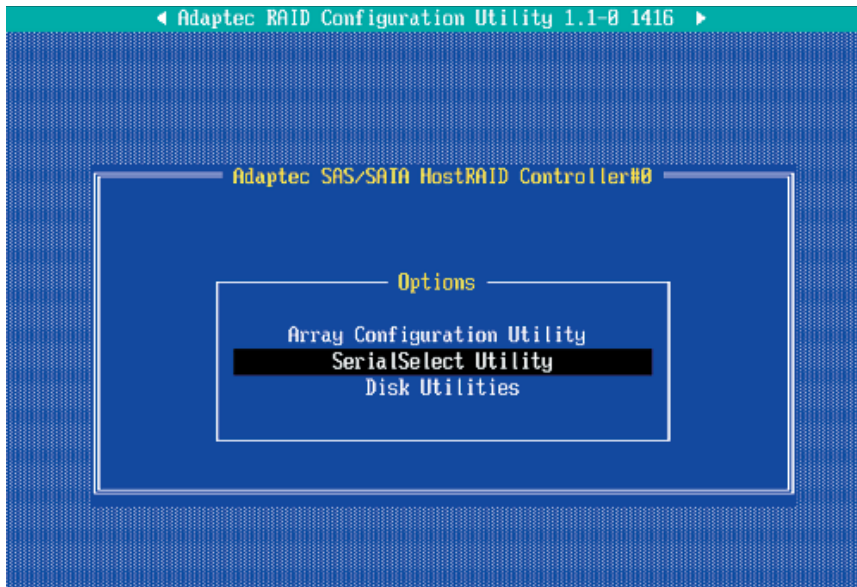

2. Use the arrow keys to select "SerialSelect Utility" and press <Enter> to access the Controller Configuration submenu:

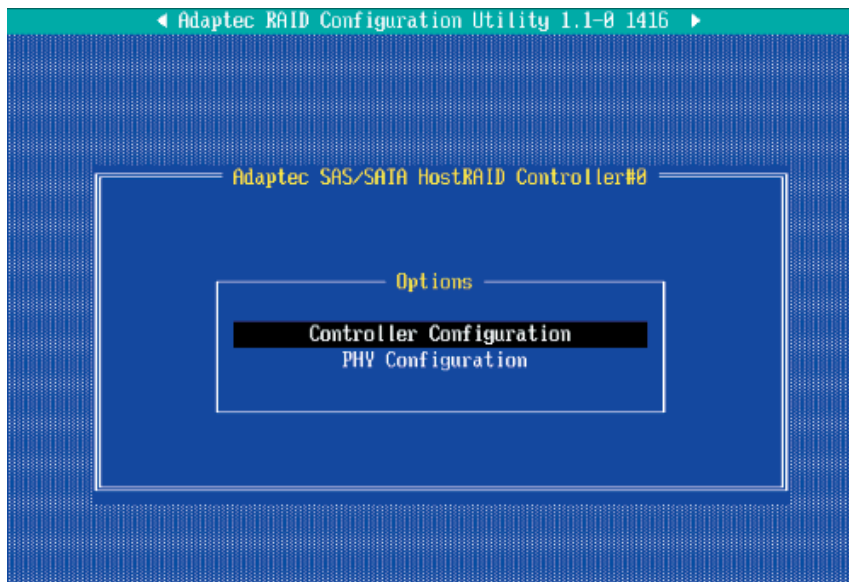

To Set Controller Configuration:

3. Select "Controller Configuration" and press <Enter> to access the submenu as shown below:

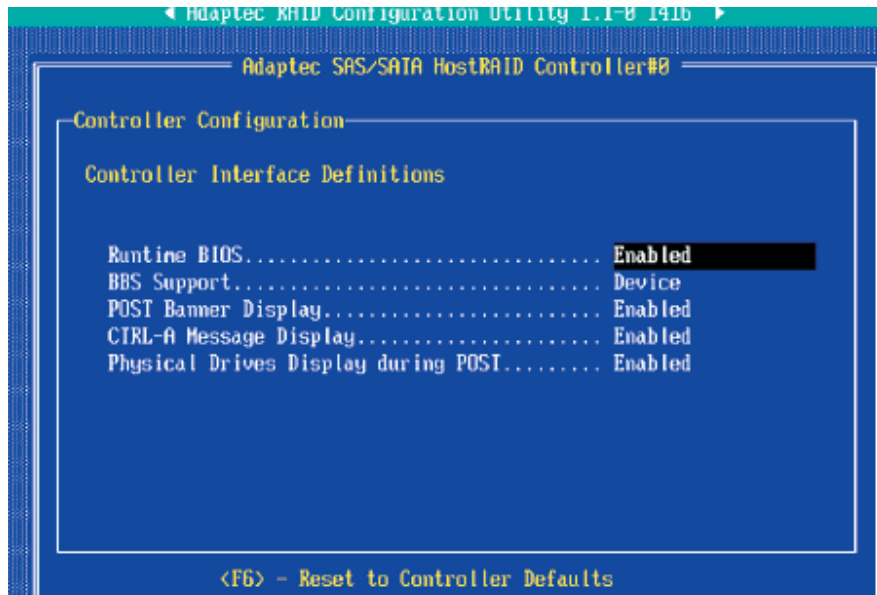

4. Use the arrow keys to select an item. Then, press <Enter> and the arrow keys to configure the setting for the item selected.

5. To load the default settings, press <F6>.

(**Note:** The default setting for each item is listed below:

Runtime BIOS: Enabled,

BBS Support: Device,

POST Banner Display: Enabled,

CTRL-A Message Display: Enabled,

Physical Drives Display during POST: Enabled,)

6. Press <Esc> to return to the previous menu and to exit the utility.

To Set Physical Configuration:

1. Turn on your computer and press <Ctrl> <A> when prompted to access the Adaptec RAID Configuration Utility.
2. Use the arrow keys to select "SerialSelect Utility" and press <Enter> to access the Physical Configuration submenu as shown below:

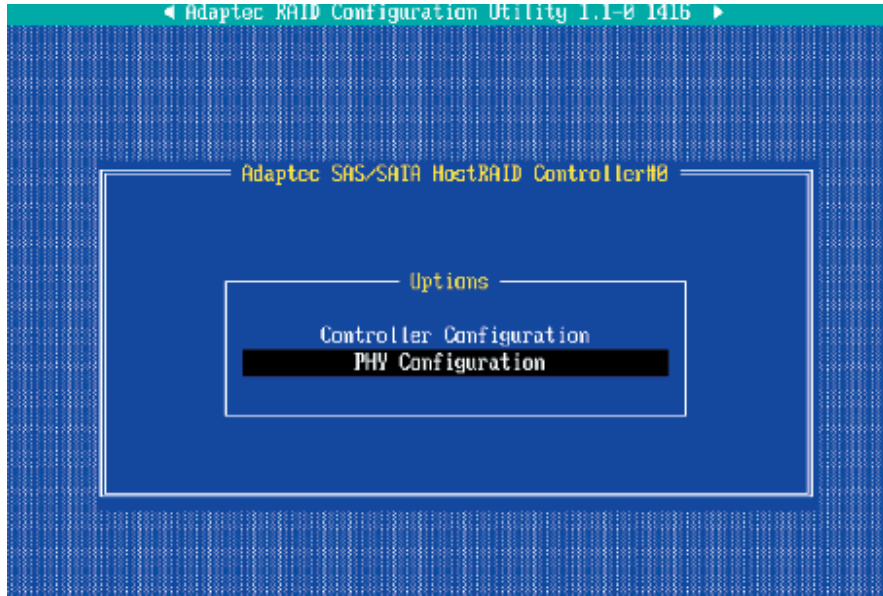

3. Select "Physical Configuration" and press <Enter> to access SAS Device Configuration submenu as shown below:

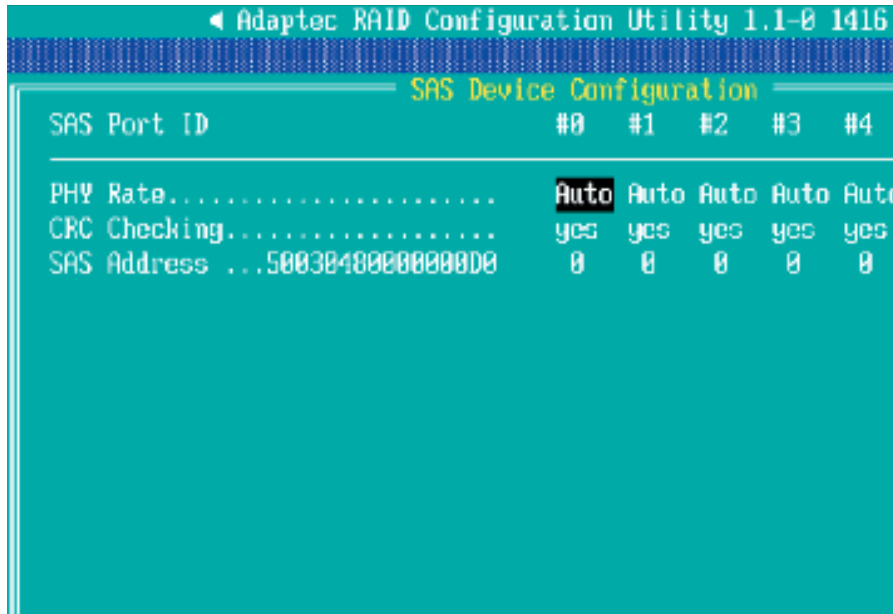

4. Use the arrow keys to select an item. Then, press <Enter> and the arrow keys to configure the item selected.
5. To load default settings, press <F6>.
6. Press <Esc> to return to the previous menu and to exit the utility.

Using the Disk Utilities

The Disk Utilities enable you to format or verify the media of your Serial ATA hard disks.

To access the disk utilities:

1. Turn on your computer and press <Ctrl> <A> when prompted to access the Adaptec RAID Configuration Utility (as shown in the screen below.)

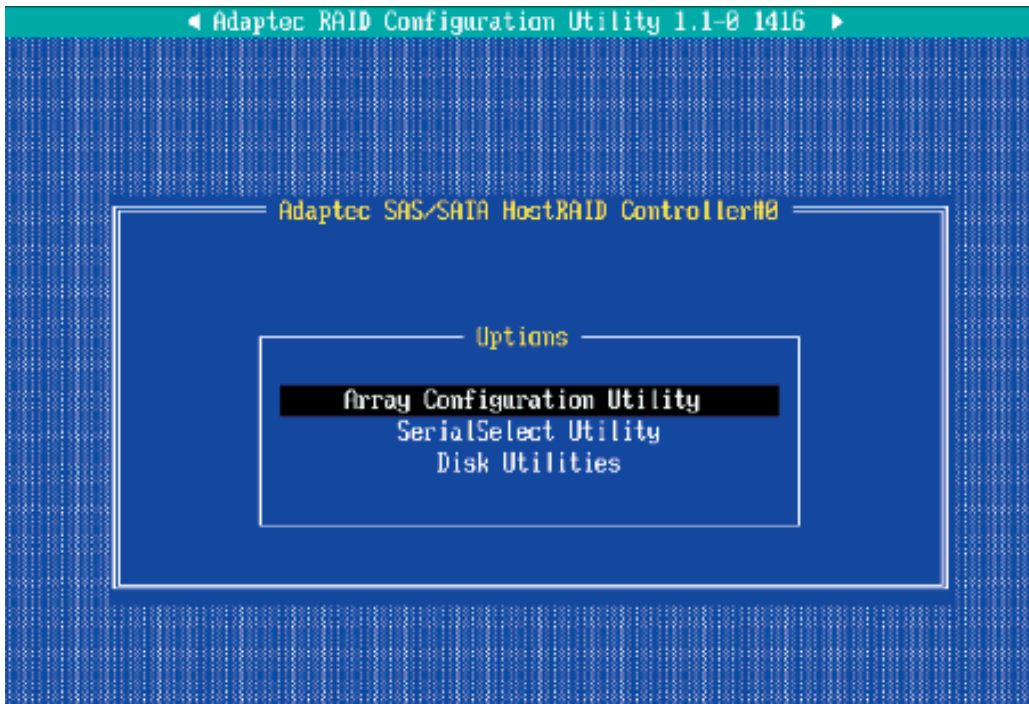

2. From the Adaptec RAID Configuration Utility menu, select Disk Utilities from the screen as shown above and press <Enter>.
3. When the submenu appears, select the desired disk and press <Enter>.

The following options are available:

1. **Format Disk**—Simulates a low-level format of the hard drive by writing zeros to the entire disk. (**Note:** Serial ATA drives are low-level formatted at the factory and do not need to be low-level formatted again.)

(**Caution:** Formatting disk erases all data on the drive. Be sure to back up your data before performing this operation.)

2. **Verify Disk Media**—Scans the media of a disk drive for defects.

To Exit Adaptec RAID Configuration Utility

1. Once you have completed RAID array configurations, press <ESC> to exit. The following screen will appear.
2. Press <Yes> to exit the Adaptec RAID Configuration Utility.

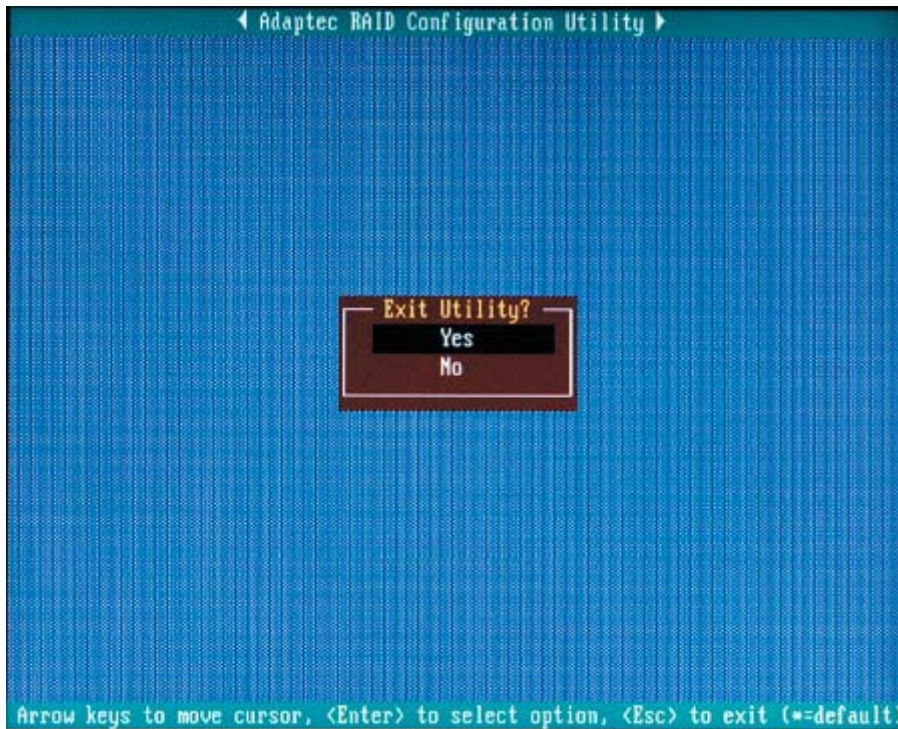

(For more information regarding the Adaptec RAID Utility, please refer to the Adaptec User Guide included in the CD that came with your shipping package. You can also download a copy of the Adaptec User Guide from our web site at: www.supermicro.com.)

C-2 Installing the ESB2/SAS Driver and the Operating System

1. Insert Supermicro's bootable CD that came with the package into the CD Drive during the system reboot, and the screen: "Super Micro Driver Diskette Maker" will appear.
2. From the list displayed on the screen, choose the option that best suits your need:
3. a. To use the Adaptec SAS Controller, select the item-"Adaptec SAS Driver" from the CD, and press <Enter> ,
4. b. To use the Intel ESB2 SATA RAID Controller, select "Intel" from the BIOS item-"ICH RAID Code Base" in the Main Setup Menu, and then select "Intel ESB2 SATARaid Driver" from the CD and press <Enter> ,
5. c. To use the Intel ESB2 SATA RAID Driver produced by Adaptec, select "Adaptec" from the BIOS item-"ICH RAID Code Base" in the Main Setup Menu, and then select "Intel ESB2 SATARaid Driver by 3rd Party (Adaptec)" from the CD and press <Enter> ,
6. From the next screen displayed, choose the OS driver you want to install and press <Enter> .
7. Insert a formatted diskette into drive A: and press <Enter> as prompted.
8. Exit the program after the process is completed. Then, reboot the system.
9. Insert the Microsoft Windows OS Setup CD in the CD Driver, and the system will start to boot up from CD.
10. Press the <F6> key when the message-"Press F6 if you need to install a third party SCSI or RAID driver" displays.
11. When the Windows OS Setup screen appears, press "S" to specify additional device(s).
12. Insert the driver diskette-"Adaptec Embedded Serial ATA Raid Controller Driver" into Drive A: and press the <Enter> key.
13. Choose the Adaptec Embedded Host Serial ATA Raid Controller from the list indicated in the Windows OS Setup Screen, and press the <Enter> key.
14. Press the <Enter> key to continue the installation process. (If you need to specify any additional devices to be installed, do it at this time.) Once all devices are specified, press the <Enter> key to continue with the installation.
15. From the Windows OS Setup screen, press the <Enter> key. The OS Setup will automatically load all device files, and, then, continue the Windows OS installation.

16. After Windows OS Installation is completed, the system will automatically reboot.

Note: The Intel RAID Configuration Utility is only available for systems with two or more drives installed. The Intel RAID Utility screen will not display in systems with one drive installed.

Appendix D

Configuring Intel SATA HostRAID and the Windows Operating System

After all the hardware has been installed, you must first configure the Intel ESB2 SATA RAID before you install the Windows Operating System and other software drivers.

Important Notes to the User:

Note 1: If you do not wish to configure onboard SATA RAID functions, please go directly to Section D-2 and Appendix E for the Windows Operating System & Other Software Installation. For more information on the Intel SATA HostRAID settings, refer to the documentation posted on our website at www.supermicro.com.

Note 2: Please refer to Appendix C for the Adaptec SAS/SATA HostRAID configuration instructions.

D-1 Introduction to Serial ATA and Parallel ATA

To configure the SATA RAID functions, you must first use the Intel ESB2 SATA RAID Utility program to configure the RAID Level that you desire before installing the Windows XP/2000/2003 operating system and other software drivers. (The necessary drivers are all included in the Supermicro CD that came with your motherboard.) **Note:** the current version of the ESB2 SATA RAID Utility can only support Windows XP/2000/2003 Operating Systems.

Serial ATA (SATA)

Serial ATA (SATA) is a physical storage interface that uses a single cable with a minimum of four wires to create a point-to-point connection between devices. It is a serial link, which supports transfer rates up to 3Gbps. Because the serial cables used in Serial ATA are thinner than the traditional cables used in Parallel ATA (PATA), SATA systems have better airflow and can be installed in smaller chassis than Parallel ATA. In addition, the cables used in PATA are limited to a length of 40cm, while Serial ATA cables can be up to one meter in length. Overall, SATA provides better functionality than PATA.

Introduction to the Intel ESB2 Serial RAID Controller Hub

Located in the South Bridge of the 5000X (Green creek) chipset, the I/O Controller Hub (ESB2) provides the I/O subsystem with access to the rest of the system. It supports an 1-channel UltraATA/100 Bus Master IDE controller (PATA) and six Serial ATA (SATA) ports. The ESB2 supports the following PATA and SATA device configurations: Legacy mode and Native mode.

The Intel HostRAID Configurations

The following types of Intel's HostRAID configurations are supported:

RAID 0 (Data Striping): this writes data in parallel, interleaved ("striped") sections of two hard drives. Data transfer rate is doubled over using a single disk.

RAID1 (Data Mirroring): an identical data image from one drive is copied to another drive. The second drive must be the same size or larger than the first drive.

RAID 10 (Striping & Mirroring): RAID 0 and 1 schemes are combined (without parity information) to get the benefits of both.

RAID 5: both data and parity information are striped and mirrored across three or more hard drives.

The Intel Matrix Storage

The Intel Matrix Storage, supported by the ESB2, allows the user to create RAID 0, RAID 1, RAID 10 and RAID 5 sets by using only six identical hard disk drives. The Intel Matrix Storage Technology creates two partitions on each hard disk drive and generate a virtual RAID 0, RAID 1, RAID 10 and RAID 5 sets. It also allows you the change the HDD partition size without any data.

Configuring BIOS settings for SATA RAID Functions (Native Mode)

1. Press the key during system bootup to enter the BIOS Setup Utility.

Note: If it is the first time powering on the system, we recommend you load the Optimized Default Settings. If you have already done so, please skip to Step 3.

2. Use the arrow keys to select the "Exit" Settings. Once in the "Exit" settings, Scroll down to select "Load Optimized Default Settings" and press the <Enter> key. Select "OK" to confirm the selection. Press the <Enter> key to load the default settings for the BIOS.

3. Use the arrow keys to select the "Main" section in BIOS.

4. Scroll down to "SATA Controller Mode" and press the <Enter> key to select "Enhanced"

5. Scroll down to "SATA RAID Enabled" and press <Enter>. Then, select "Enabled."

6. Scroll down to "Exit". Select "Save and Exit" from the "Exit" menu. Press the <Enter> key to save the changes and exit the BIOS.

7. Once you've exited the BIOS Utility, the system will re-boot.

8. During the system boot-up, press the <Ctrl> and <I> keys simultaneously to run the Intel RAID Configuration Utility when prompted by the following message: Press <Ctrl> <I> for the Intel RAID Configuration Utility.

Note: The Intel RAID Configuration Utility is only available for systems with two or more drives installed. The Intel RAID Utility screen will not display in systems with one drive installed.

Using the Intel ESB2 SATA RAID Utility Program

1. Creating, Deleting and Resetting RAID Volumes:

- a. After the system exits from the BIOS Setup Utility, the system will automatically reboot. The following screen appears after Power-On Self Test.

```

RAID Volumes:
None defined.

Physical Disks:
Port Drive Model      Serial #              Size   Type/Status(Vol ID)
0    WDC WD2500SD-01K  WD-HMAL72034971      232.9GB Non-RAID Disk
1    WDC WD2500SD-01K  WD-HMAL72034599      232.9GB Non-RAID Disk
2    WDC WD2500JD-00F  WD-HMAEH1376109      232.9GB Non-RAID Disk
3    WDC WD2500JD-00F  WD-HMAEH1449527      232.9GB Non-RAID Disk

Press <CTRL-I> to enter Configuration Utility...

Adaptec SCSI BIOS v4.30.0
Copyright 2003 Adaptec, Inc. All Rights Reserved.

<<< Press <Ctrl><A> for SCSISelect(TM) Utility! >>>

Slot Ch ID LUN Vendor      Product              Size Bus Status
-----
04  A  10  0

```

- b. When you see the above screen, press the <Ctrl> and the <I> keys simultaneously to have the main menu of the SATA RAID Utility appear:

Note: All graphics and screen shots shown in the manual are for reference only. The screen shots shown in the manual do not imply Supernicro's endorsement or non-endorsement on any 3rd party's product. Your screens may or many not look exactly the same as the graphics shown in this manual.

Creating a RAID 0 Volume:

1. Select "Create RAID Volume" from the main menu and press the <Enter> key. The following screen will appear:



2. Specify a name for the RAID 0 set and press the <Tab> key or the <Enter> key to go to the next field. (You can use the <Esc> key to select the previous menu.)
3. When RAID Level item is highlighted, press the <Up Arrow>, <Down Arrow> keys to select RAID 0 (Stripe) and hit <Enter>.
4. When the Disks item is highlighted, press <Enter> to select the HDD to configure as RAID. The following pop-up screen (See the note on Page D-3) displays:

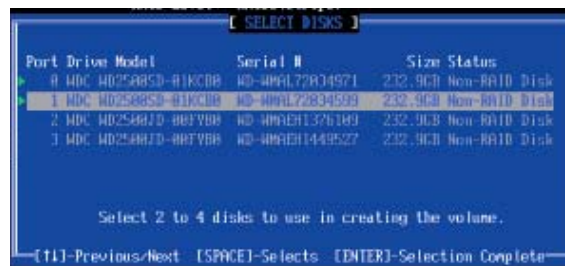

5. Use the <Up Arrow>, <Down Arrow> keys to highlight a drive and press <Space> to select it. A triangle appears to confirm the selection of the drive.
6. Use the <Up Arrow>, <Down Arrow> keys to select the stripe size, ranging from 4 KB to 128 KB for the RAID 0 array, and hit <Enter>. **Note:** For a server, please use a lower stripe size, and for a multimedia system, use a higher stripe size. The default stripe size is 128 KB.)
7. Press <Enter> when the Create Volume item is highlighted. A warning message displays.
8. When asked "Are you sure you want to create this volume (Y/N), press "Y" to create the RAID volume, or type "N" to go back to the Create Volume menu.

Creating a RAID 1 Volume:

1. Select "Create RAID Volume" from the main menu and press the <Enter> key. The following screen will appear:

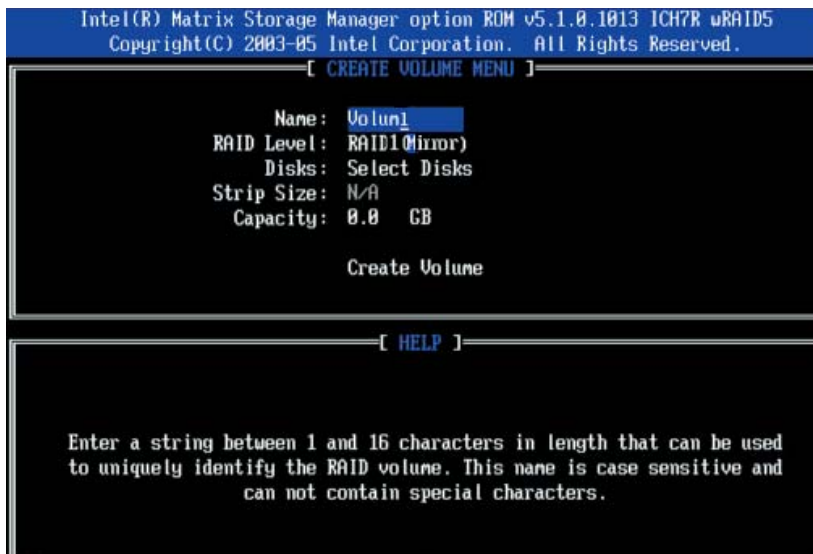

2. Specify a name for the RAID 1 set and press the <Tab> key or the <Enter> key to go to the next field. (You can use the <Esc> key to select the previous menu.)
3. When RAID Level item is highlighted, press the <Up Arrow>, <Down Arrow> keys to select RAID 1 (Mirror) and hit <Enter>.
4. When the Capacity item is highlighted, enter your RAID volume capacity and hit <Enter>. The default setting is the maximum capacity allowed.
5. Press <Enter> when the Create Volume item is highlighted. A warning message displays.
6. When asked "Are you sure you want to create this volume (Y/N), press "Y" to create the RAID volume, or type "N" to go back to the Create Volume menu.

Creating a RAID 10 (RAID 1+ RAID 0):

1. Select "Create RAID Volume" from the main menu and press the <Enter> key. The following screen will appear:

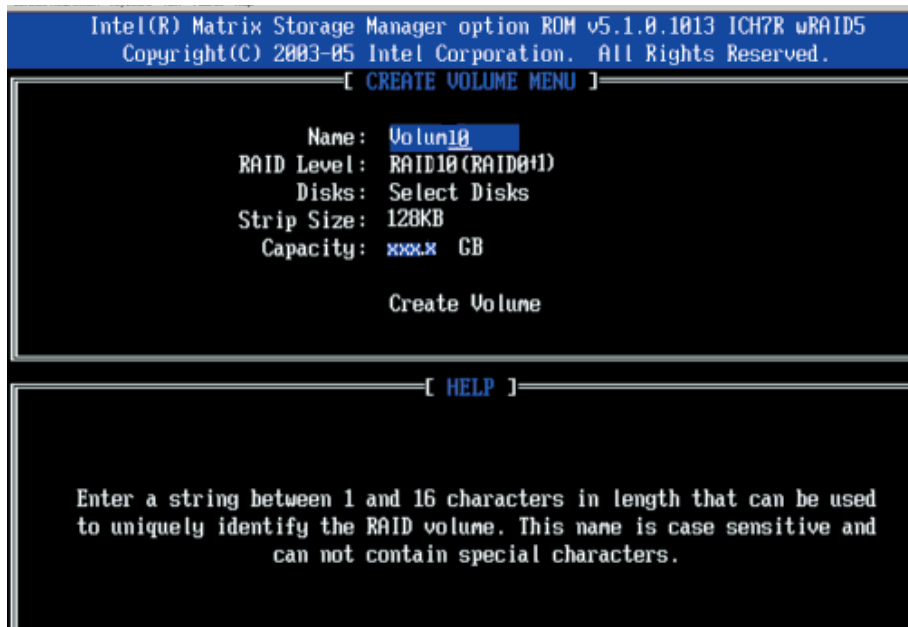

2. Specify a name for the RAID 10 set and press <Enter>.
3. When RAID Level item is highlighted, use the <Up Arrow>, <Down Arrow> keys to select RAID 10 (RAID1 + RAID0) and hit <Enter>.
4. When the Stripe Size is highlighted, use the <Up Arrow>, <Down Arrow> keys to select the stripe size from 4 KB to 128 KB for your RAID 10 and hit <Enter>. The default setting is 64 KB. (**Note:** For a server, please use a lower stripe size, and for a multimedia system, use a higher stripe size.)
5. When the RAID Volume Capacity item is highlighted, enter your RAID volume capacity and hit <Enter>. The default setting is the maximum capacity allowed.
6. Press <Enter> when the Create Volume item is highlighted. A warning message displays.
7. When asked "Are you sure you want to create this volume (Y/N)", press "Y" to create the RAID volume, or type "N" to go back to the Create Volume menu.

Creating a RAID 5 Set (Parity):

1. Select "Create RAID Volume" from the main menu and press the <Enter> key. The following screen will appear:



2. Specify a name for the RAID 5 set and press <Enter>.
3. When the Raid Level is highlighted, use the <Up Arrow>, <Down Arrow> keys to select RAID 5 (Parity) and hit <Enter>.
4. When the Disk item is highlighted, press <Enter> to select the HDD to configure as RAID. The following pop-up screen (See the note on Page C-3) displays:

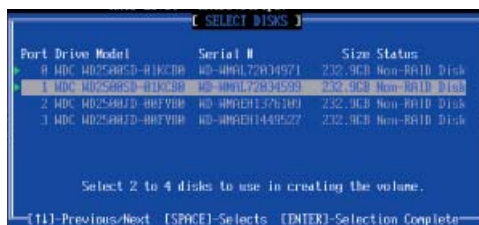

5. Use the <Up Arrow>, <Down Arrow> keys to highlight a drive and press <Space> to select it. A triangle appears to confirm the selection of the drive.
6. Use the <Up Arrow>, <Down Arrow> keys to select the stripe size, ranging from 4 KB to 128 KB for the RAID 5 array, and hit <Enter>. (**Note:** For a server, please use a lower stripe size, and for a multimedia system, use a higher stripe size. The default stripe size is 128 KB.)
7. Enter your desired RAID volume capacity and press <Enter> when the capacity item is highlighted. The default setting is the maximum capacity allowed.
8. Press Enter when the Create Volume item is highlighted. A warning message displays.
9. When asked "Are you sure you want to create this volume (Y/N)", press "Y" to create the RAID volume, or type "N" to go back to the Create Volume menu.

Deleting RAID Volume:



Warning: Be sure to back up your data before deleting a RAID set. You will lose all data on the disk drives when deleting a RAID set.)

1. From the main menu, select item2-Delete RAID Volume, and press <Enter>.
2. Use the <Up Arrow>, <Down Arrow> keys to select the RAID set you want to delete and press . A Warning message displays.
3. When asked "Are you sure you want to delete this volume (Y/N), press "Y" to delete the RAID volume, or type "N" to go back to the Delete Volume menu.

Resetting to Non-RAID and Resetting a RAID HDD

(**Warning:** Be cautious when you reset a RAID volume HDD to non-RAID or Resetting a RAID HDD. Resetting a RAID volume HDD or Resetting a RAID HDD will reformat the HDD and delete the internal RAID structure on the drive.)

1. From the main menu, select item3-Reset Disks to Non- RAID, and press <Enter>. The following screen will appear:

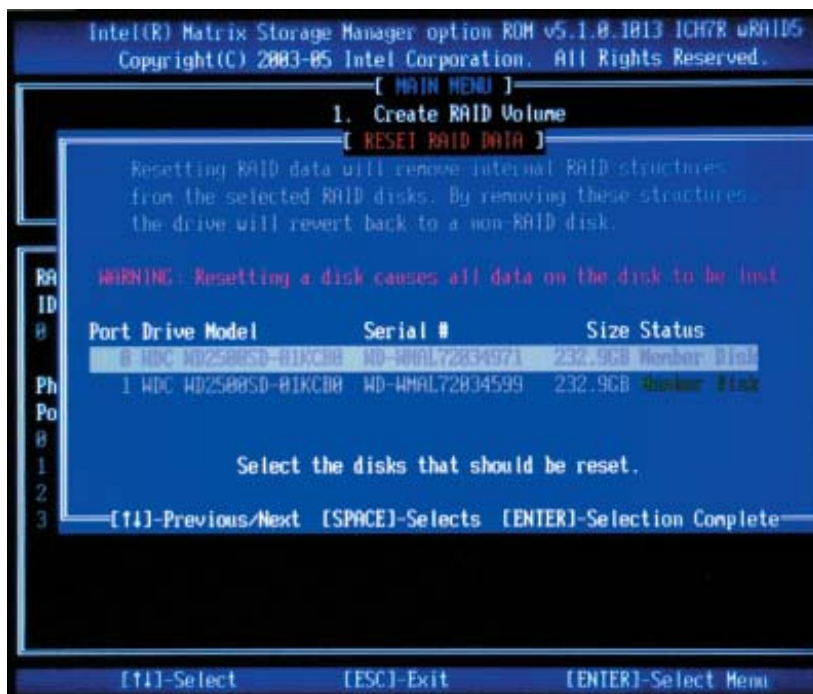

2. Use the <Up Arrow>, <Down Arrow> keys to highlight the RAID set drive to reset and press <Space> to select.
3. Press <Enter> to reset the RAID set drive. A Warning message displays.
4. Press "Y" to reset the drive, or type "N" to go back to the main menu.

Exiting the Intel Matrix Storage Manager Utility:

1. From the main menu, select item4-Exit, and press <Enter>. A warning message will appear.
2. Press "Y" to reset the drive, or type "N" to go back to the main menu.

D-2 Installing the Windows XP/2000/2003 for systems with RAID Functions

New Operating System-Windows XP/2000/2003 Installation

1. Insert the Microsoft Windows XP/2000/2003 Setup CD in the CD Driver, and the system will start booting up from CD.
2. Press the <F6> key when the message-" Press F6 if you need to install a third party SCSI or RAID driver" displays.
3. When the Windows XP/2000/2003 Setup screen appears, press "S" to specify additional device(s).
4. Insert the driver diskette-"Intel AA RAID XP/2000/2003 Driver for ESB2 into Drive A: and press the <Enter> key.
5. Choose the Intel(R) ESB2 SATA RAID Controller from the list indicated in the XP/2000/2003 Setup Screen, and press the <Enter> key.
6. Press the <Enter> key to continue the installation process. (If you need to specify any additional devices to be installed, do it at this time.) Once all devices are specified, press the <Enter> key to continue with the installation.
7. From the Windows XP/2000/2003 Setup screen, press the <Enter> key. The XP/2000/2003 Setup will automatically load all device files and then, continue the Windows XP/2000/2003 installation.
8. After Windows XP/2000/2003 Installation is completed, the system will automatically reboot.

Note: the current version of the ESB2 SATA RAID Utility can only support the Windows XP/2000/2003 Operating System.

Appendix E

Installing Other Software Programs and Drivers

E-1 Installing Other Software Programs and Drivers

After you've installed the Windows Operating System, a screen as shown below will appear. You are ready to install software programs and drivers that have not yet been installed. To install these software programs and drivers, click the icons to the right of these items.

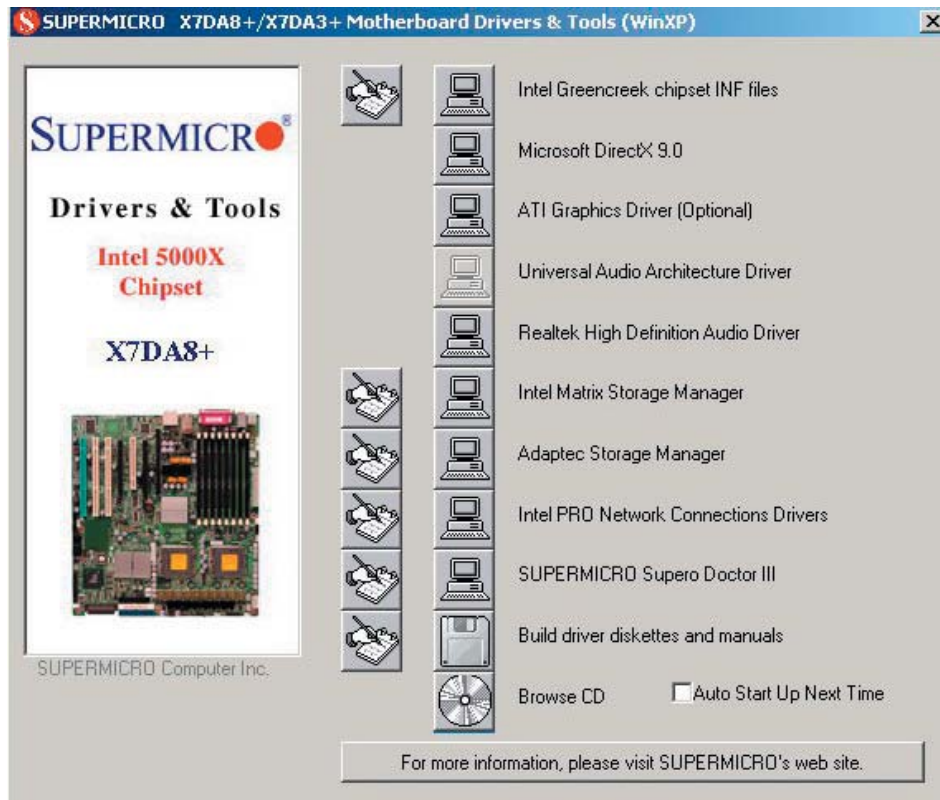

Driver/Tool Installation Display Screen

Note: Click the icons showing a hand writing on the paper to view the readme files for each item. Click a computer icon to the right of an item (from top to the bottom) one at a time. **After installing each item, you must re-boot the system before proceeding with the next item on the list.** The bottom icon with a CD on it allows you to view the entire contents of the CD.

E-2 Configuring Supero Doctor III

The Supero Doctor III program is a Web-base management tool that supports remote management capability. It includes Remote and Local Management tools. The local management is called the SD III Client. The Supero Doctor III program included on the CDROM that came with your motherboard allows you to monitor the environment and operations of your system. Supero Doctor III displays crucial system information such as CPU temperatures, system voltages and fan status. See the Figure below for a display of the Supero Doctor III interface.

Notes:

1. The default password and username are ADMIN.
2. In the Windows OS environment, the Supero Doctor III settings take precedence over the BIOS settings. When first installed, Supero Doctor III adopts the temperature threshold settings previously set in the BIOS. Any subsequent changes to these thresholds must be made within Supero Doctor, since the SD III settings override the BIOS settings. For the Windows OS to adopt the BIOS temperature threshold settings, please change the SDIII settings to be the same as those set in the BIOS.

Supero Doctor III Interface Display Screen-I (Health Information)



Supero Doctor III Interface Display Screen-II (Remote Control)



Note: SD III Software Revision 1.0 can be downloaded from our Web site at: ftp://ftp.supermicro.com/utility/Supero_Doctor_III/. You can also download SDIII User's Guide at: <http://www.supermicro.com/PRODUCT/Manuals/SDIII/UserGuide.pdf>. For Linux, we will still recommend that you use Supero Doctor II.

Notes

Free Manuals Download Website

<http://myh66.com>

<http://usermanuals.us>

<http://www.somanuals.com>

<http://www.4manuals.cc>

<http://www.manual-lib.com>

<http://www.404manual.com>

<http://www.luxmanual.com>

<http://aubethermostatmanual.com>

Golf course search by state

<http://golfingnear.com>

Email search by domain

<http://emailbydomain.com>

Auto manuals search

<http://auto.somanuals.com>

TV manuals search

<http://tv.somanuals.com>