

SUPERO[®]

SUPERO[®] X6DH8-G2
SUPERO[®] X6DHE-G2

USER'S MANUAL

Revision 1.0c

The information in this User's Manual has been carefully reviewed and is believed to be accurate. The vendor assumes no responsibility for any inaccuracies that may be contained in this document, makes no commitment to update or to keep current the information in this manual, or to notify any person or organization of the updates.

Please Note: For the most up-to-date version of this manual, please see our web site at www.supermicro.com.

SUPERMICRO COMPUTER reserves the right to make changes to the product described in this manual at any time and without notice. This product, including software, if any, and documentation may not, in whole or in part, be copied, photocopied, reproduced, translated or reduced to any medium or machine without prior written consent.

IN NO EVENT WILL SUPERMICRO COMPUTER BE LIABLE FOR DIRECT, INDIRECT, SPECIAL, INCIDENTAL, OR CONSEQUENTIAL DAMAGES ARISING FROM THE USE OR INABILITY TO USE THIS PRODUCT OR DOCUMENTATION, EVEN IF ADVISED OF THE POSSIBILITY OF SUCH DAMAGES. IN PARTICULAR, THE VENDOR SHALL NOT HAVE LIABILITY FOR ANY HARDWARE, SOFTWARE, OR DATA STORED OR USED WITH THE PRODUCT, INCLUDING THE COSTS OF REPAIRING, REPLACING, INTEGRATING, INSTALLING OR RECOVERING SUCH HARDWARE, SOFTWARE, OR DATA.

Any disputes arising between manufacturer and customer shall be governed by the laws of Santa Clara County in the State of California, USA. The State of California, County of Santa Clara shall be the exclusive venue for the resolution of any such disputes. Supermicro's total liability for all claims will not exceed the price paid for the hardware product.

Unless you request and receive written permission from SUPER MICRO COMPUTER, you may not copy any part of this document.

Information in this document is subject to change without notice. Other products and companies referred to herein are trademarks or registered trademarks of their respective companies or mark holders.

Copyright © 2005 by SUPER MICRO COMPUTER INC.
All rights reserved.

Printed in the United States of America

Preface

About This Manual

This manual is written for system integrators, PC technicians and knowledgeable PC users. It provides information for the installation and use of the **SUPER** X6DH8-G2/X6DHE-G2 motherboard. The **SUPER** X6DH8-G2/X6DHE-G2 supports single or dual Intel® Nocona™ processors at a 800 MHz front side bus. Based upon Intel's NetBurst microarchitecture, the Nocona processor supports the IA-32 software and includes features found in the Xeon™ processor such as Hyper Pipelined Technology, which includes a multi-stage pipeline, allowing the processor to operate at much higher core frequencies. Packaged in a 604-pin Flip Chip Micro Pin Grid Array(FC-mPGA4) platform in a Zero Insertion Force(ZIF) socket (mPGA 604), the Nocona Processor, which supports Hyper-Threading Technology and Intel EM64T, is ideal for high performance workstation and server environments with up to two processors on one system bus. Please refer to the motherboard specifications pages on our web site (http://www.supermicro.com/Product_page/product-m.htm) for updates on supported processors. This product is intended to be professionally installed.

Manual Organization

Chapter 1 begins with a checklist of what should be included in your mainboard box, describes the features, specifications and performance of the motherboard and provides detailed information about the chipset.

Chapter 2 begins with instructions on handling static-sensitive devices. Read this chapter when you want to install the processor and DIMM memory modules and when mounting the mainboard in the chassis. Also refer to this chapter to connect the floppy and hard disk drives, SCSI drives, the IDE interfaces, the parallel and serial ports, the keyboard and mouse, the power supply and various control panel buttons and indicators.

If you encounter any problems, see **Chapter 3**, which describes troubleshooting procedures for the video, the memory and the setup configuration stored in CMOS. For quick reference, a general FAQ [Frequently Asked Questions] section is provided.

Chapter 4 includes an introduction to BIOS and provides detailed information on running the CMOS Setup utility.

Appendix A provides BIOS POST codes.

Appendix B provides software and the OS installation instructions.

Table of Contents

Preface

About This Manual	iii
Manual Organization	iii

Chapter 1: Introduction

1-1 Overview	1-1
Checklist	1-1
Contacting Supermicro	1-2
SUPER [®] X6DH8-G2/X6DHE-G2 Image	1-3
SUPER [®] X6DH8-G2/X6DHE-G2 Layout	1-4
Quick Reference	1-5
Motherboard Features	1-6
Intel Lindenhurst Chipset: System Block Diagram	1-8
1-2 Chipset Overview	1-9
1-3 Special Features	1-10
Recovery from AC Power Loss	1-10
1-4 PC Health Monitoring	1-10
1-5 ACPI Features	1-11
1-6 Power Supply	1-13
1-7 Super I/O	1-13

Chapter 2: Installation

2-1 Static-Sensitive Devices	2-1
Precautions	2-1
Unpacking	2-1
2-2 PGA Processor and Heatsink Installation	2-2
2-3 Installing DIMMs	2-6
2-4 I/O Ports/Control Panel Connectors	2-7
2-5 Connecting Cables	2-9
ATX Power Connector	2-9
Processor Power Connector	2-9
NMI Button	2-10
Power LED	2-10
HDD LED	2-11
NIC1 LED	2-11
Overheat LED	2-12
Power Fail LED	2-12
Reset Button	2-13

Power Button	2-13
Chassis Intrusion	2-14
Universal Serial Bus (USB0/1)	2-14
Extra Universal Serial Bus Headers (USB2/3)	2-15
Serial Ports	2-15
GLAN (Ethernet Port)	2-16
ATX PS/2 Keyboard and Mouse Ports	2-16
Fan Headers	2-17
Power LED/Speaker Header (JD1)	2-17
Wake-On-Ring	2-18
Wake-On-LAN	2-18
SMB	2-19
SMB PWR	2-19
2-6 Jumper Settings	2-20
Explanation of Jumpers	2-20
GLAN Enable/Disable	2-20
CMOS Clear	2-21
Watch Dog	2-21
VGA Enable	2-22
Alarm Reset	2-22
PW R Fault	2-23
SCSI Enable/Disable	2-24
SCSI Channel A/B Termination	2-24
2-7 Onboard Indicators	2-25
GLAN LEDs	2-25
2-8 Parallel Port, Floppy/Hard Disk Drive and SCSI Connections	2-26
Parallel Port Connector	2-26
Floppy Connector	2-27
IDE Connectors	2-27
SCSI Connectors	2-28

Chapter 3: Troubleshooting

3-1 Troubleshooting Procedures	3-1
Before Power On	3-1
No Power	3-1
No Video	3-1
Memory Errors	3-2
Losing the System's Setup Configuration	3-2
3-2 Technical Support Procedures	3-2

3-3 Frequently Asked Questions 3-3
3-4 Returning Merchandise for Service 3-4

Chapter 4: BIOS

4-1 Introduction 4-1
4-2 Running Setup 4-2
4-3 Main BIOS Setup 4-2
4-4 Advanced Setup 4-6
4-5 Security Setup 4-18
4-6 Boot Setup 4-20
4-7 Exit 4-21

Appendices:

Appendix A: BIOS POST Codes A-1
Appendix B: Installing Software Drivers and the Operating System B-1

Chapter 1

Introduction

1-1 Overview

Checklist

Congratulations on purchasing your computer motherboard from an acknowledged leader in the industry. Supermicro boards are designed with the utmost attention to detail to provide you with the highest standards in quality and performance. Check that the following items have all been included with your motherboard. If anything listed here is damaged or missing, contact your retailer. All are included in the Retail Box.

One (1) Supermicro Mainboard

One (1) ribbon cable for IDE devices

One (1) floppy ribbon cable

One (1) Ultra 320 SCSI cable (*X6DH8-G2 only)

One (1) COM2 cable

One (1) USB (2-port) cable

One (1) SATA cable

One (1) I/O backpanel shield

One (1) Supermicro CD containing drivers and utilities

One (1) User's/BIOS Manual

One (1) Ultra 320 SCSI User's Manual (*X6DH8-G2 only)

Contacting Supermicro

Headquarters

Address: SuperMicro Computer, Inc.
980 Rock Ave.
San Jose, CA 95131 U.S.A.

Tel: +1 (408) 503-8000

Fax: +1 (408) 503-8008

Email: marketing@supermicro.com (General Information)
support@supermicro.com (Technical Support)

Web Site: www.supermicro.com

Europe

Address: SuperMicro Computer B.V.
Het Sterrenbeeld 28, 5215 ML
's-Hertogenbosch, The Netherlands

Tel: +31 (0) 73-6400390

Fax: +31 (0) 73-6416525

Email: sales@supermicro.nl (General Information)
support@supermicro.nl (Technical Support)
rma@supermicro.nl (Customer Support)

Asia-Pacific

Address: SuperMicro, Taiwan
D5, 4F, No. 16 Chien-Ba Road
Chung-Ho 235, Taipei Hsien, Taiwan, R.O.C.

Tel: +886-(2) 8226-3990

Fax: +886-(2) 8226-3991

Web Site: www.supermicro.com.tw

Technical Support:

Email: support@supermicro.com.tw

Tel: 886-2-8228-1366, ext.132 or 139

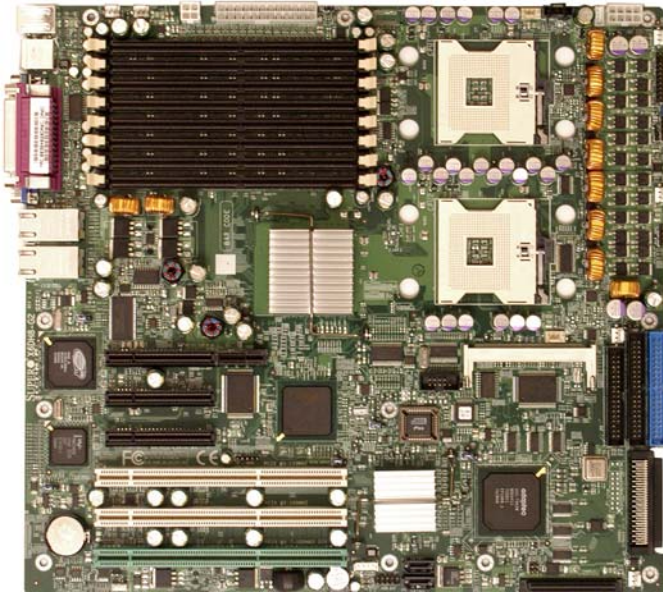
Figure 1-1. SUPER[®] X6DH8-G2/X6DHE-G2 Image

(*Note: The drawings and pictures shown in this manual were based on the latest PCB Revision available at the time of publishing of the manual. The motherboard you've received may or may not look exactly the same as the graphics shown in the manual.)

Figure 1-2. SUPER X6DH8-G2/X6DHE-G2 Motherboard Layout

(not drawn to scale)

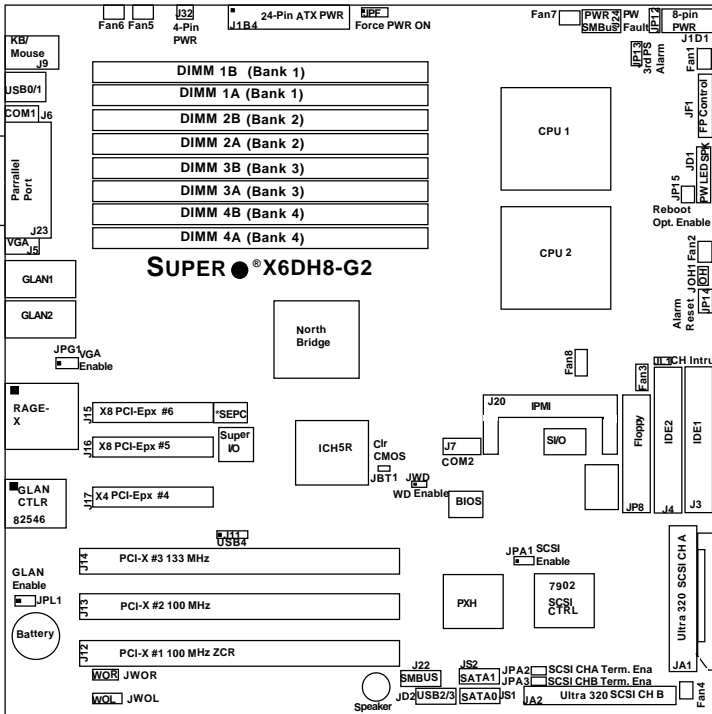

1. Jumpers not indicated are for test purposes only.
2. See Chapter 2 for detailed information on jumpers, I/O ports and JF1 front panel connections.
3. "■" indicates the location of Pin 1.
4. SCSI is for the X6DH8-G2 only
5. SEPC: Supermicro Enhanced Power Connector, specially designed to support Supermicro 2U Riser Card only.

Quick Reference (X6DH8-G2/X6DHE-G2)

(*Please refer to Chapter 2 for pin definitions and detailed information.)

<u>Jumper</u>	<u>Description</u>	<u>Default Setting</u>
JBT1	CMOS Clear	See Chapter 2
JP12	PWR Fault	See Chapter 2
JP13	3rd PW Supply Fail Alarm Enable	Off (Disabled)
JP14	Alarm Reset	Off (Disabled)
JPA1	SCSI Controller Enable	Pins 1-2 (Enabled)*Note
JPA2, JPA3	SCSI CHA(JPA2),CHB(JPA3)Term.En	Off (Enabled)(*Note)
JPF	Force PWR On	Off (Normal)
JPG1	VGA Enable	Pins 1-2 (Enabled)
JPL1	GLAN Enable/Disable	Pins 1-2 (Enabled)
JWD	Watch Dog	Pins 1-2 (Reset)

<u>Connector</u>	<u>Description</u>
ATX PWR (J1B4)	Primary ATX PWR Connector
Aux. PWR (J32)	+12V 4-pin Auxiliary System PWR (*Required)
CPU PWR(J1D1)	+12 V 8-pin CPU PWR Connector (*Required)

COM1 (J6)/COM2 (J7)	COM1/COM2 Serial Port Connectors
FAN 1-8	Fans 1-8 (3-pin: Fans 1-4, 4-pin: Fans 5-8)
DIMM#1A-DIMM#4B	Memory DDRII Slots
GLAN 1/2 (JLAN1/2)	G-bit Ethernet Ports
J3/J4	IDE1/2 Hard Disk Drive Connectors
J5	VGA Connector
J20	IPMI Connector
J22	System Management Bus Header
J23	Parallel (Printer) Port
J24	Power System Management Header
JA1/JA2	SCSI Channel A/Channel B Connectors(*Note)
JD1	PWR LED(pins1-3)/SpeakerHeader (pins 4-7)
JF1	Front Control Panel Connector
JL1	Chassis Intrusion Header
JOH	Overheat LED
JP8	Floppy Disk Drive Connector
JS1/JS2	Intel SATA 0/1 Connectors
JWOL	Wake-on-LAN Header
JWOR	Wake-on-Ring Header
USB 0/1	Back Panel USB Ports
USB 2/3/4	Front Panel Universal Serial Bus Headers(USB2/ 3:JD2, USB4:J11)

(*Note: for X6DH8-G2 only)

Motherboard Features

CPU

- Single or dual Intel® 604-pin Nocona™ (w/64-bit extension) processors at 800 MHz front side (system) bus speed.

Memory

- Eight 240-pin DIMM sockets supporting up to 16 GB Registered ECC DDR2-400 (PC3200) Memory

Chipset

- Intel E7520 Lindenhurst chipset

Expansion Slots

X6DH8-G2/X6DHE-G2

Three PCI-E slots (*two slots at x8@4GB/sec, one slot x4@2GB sec)

Three 64-bit PCI-X slots (*One PCI-X-133 slot, two PCI-X-100 slots)

BIOS

- 8 Mb Phoenix® Flash ROM
- DMI 2.1, PCI 2.2, ACPI 1.0, Plug and Play (PnP), SMBIOS 2.3

PC Health Monitoring

- Onboard voltage monitors for CPU cores, chipset voltage, 3.3V, +5V, +12V and 3.3V standby
- Fan status monitor with firmware/software on/off control
- CPU/chassis temperature monitors
- Environmental temperature monitor and control
- CPU slow-down on temperature overheat
- CPU thermal trip support for processor protection, +5V standby alert LED
- Power-up mode control for recovery from AC power loss
- Auto-switching voltage regulator for CPU core
- System overheat LED and control
- Chassis intrusion detection
- System resource alert

ACPI Features

- Microsoft OnNow
- Slow blinking LED for suspend state indicator
- Main switch override mechanism

Onboard I/O

- Support Adaptec 7902 dual channel Ultra 320 SCSI (*X6DH8-G2 only)
- One IPMI 2.0 socket
- Intel 8254x Gigabit Ethernet controller (PCI-X-133)
- 2 EIDE Ultra DMA/100 bus master interfaces
- 2 SATA ports (w/RAID0, RAID1, JBOD support)
- 1 floppy port interface
- 2 serial ports
- 1 EPP/ECP Parallel Port
- PS/2 mouse and PS/2 keyboard ports
- Up to 5 USB 2.0 (Universal Serial Bus) (2 ports, 3 Headers)
- Super I/O

Other

- Internal/external modem ring-on
- Wake-on-LAN (WOL)
- Console redirection
- Onboard Fan Speed Control by Thermal Management via BIOS

CD/Diskette Utilities

- BIOS flash upgrade utility and device drivers

Dimensions

- ATX Ext. 12" x 13.05" (304.8 x 331.5 mm)

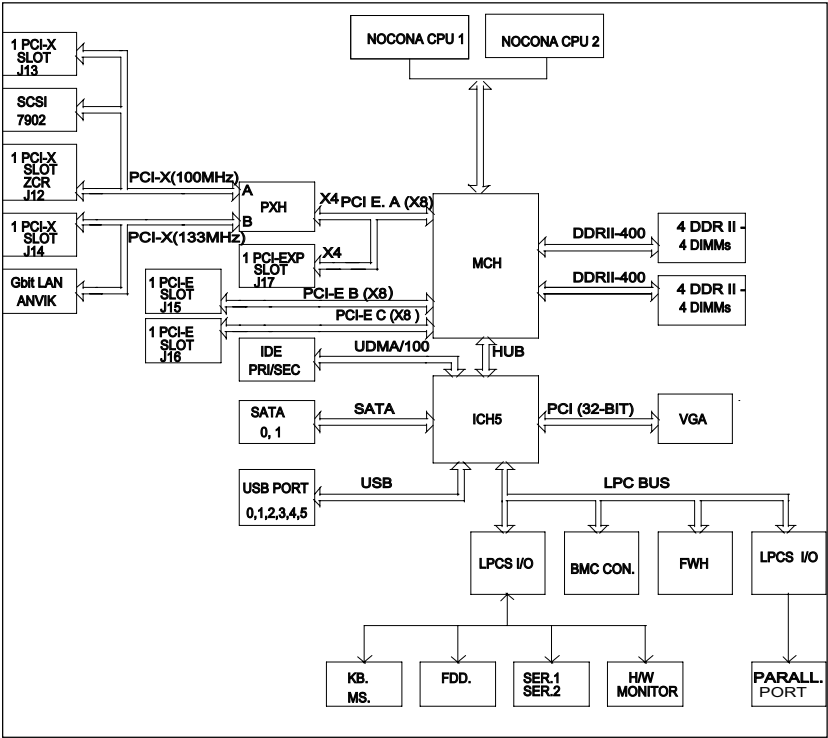

Figure 1-9. Block Diagram of the E7520 Lindenhurst Chipset

Note: This is a general block diagram. Please see the previous Motherboard Features pages for details on the features of each motherboard.

1-2 Chipset Overview

Built upon the functionality and the capability of the E7520 Lindenhurst chipset, The X6DH8-G2/X6DHE-G2 motherboard provides the performance and feature set required for dual processor-based servers, with configuration options optimized for communications, presentation, storage, computation or database applications. The Intel E7520 Lindenhurst chipset consists of the following components: the Lindenhurst Memory Controller Hub (MCH), the 82801ER I/O Controller Hub 5-R (ICH5-R), and the Intel PCI-X Hub.

The E7520 Lindenhurst MCH supports single or dual Nocona processors with Front Side Bus speeds of up to 800 MHz(*Note). Its memory controller provides direct connection to two channels of registered DDR2- 400 with a marched system bus address and data bandwidths of up to 6.4GB/s. The Lindenhurst also supports the new PCI Express high speed serial I/O interface for superior I/O bandwidth. The MCH provides three configurable x8 PCI Express interfaces which may alternatively be configured as two independent x4 PCI Express interfaces. These interfaces support connection of the MCH to a variety of other bridges that are compliant with the PCI Express Interface Specification, Rev. 1.0a. The MCH interfaces with the 82801ER I/O Controller Hub 5-R (ICH5R) via a dedicated Hub Interface supporting a peak bandwidth of 266 MB/s using a x4 base clock of 66 MHz. The PXH provide connection between a PCI Express interface and two independent PCI bus interfaces that can be configured for standard PCI 2.3 protocol, as well as the enhanced high-frequency PCI-X protocol. The PXH can be configured to support for 32- or 64-bit PCI devices running at 33 MHz, 66 MHz, 100 MHz, and 133 MHz.

The ICH5R I/O Controller Hub provides legacy support similar to that of previous ICH-family devices, but with extensions in RAID 0,1 support, Serial ATA Technology, and an integrated ASF Controller. In addition, the ICH5R also provides various integrated functions, including a two-channel Ultra ATA/100 bus master IDE controller, USB 2.0 host controllers, an integrated 10/100 LAN controller, an LPC firmware hub (FWH) and Super IO interface, a System Management Interface, a power management interface, integrated IOxAPIC and 8259 interrupt controllers.

1-3 Special Features

Recovery from AC Power Loss

BIOS provides a setting for you to determine how the system will respond when AC power is lost and then restored to the system. You can choose for the system to remain powered off (in which case you must hit the power switch to turn it back on) or for it to automatically return to a power-on state. See the Power Lost Control setting in the Advanced BIOS Setup section (Peripheral Device Configuration) to change this setting. The default setting is Always On.

1-4 PC Health Monitoring

This section describes the PC health monitoring features of the X6DH8-G2/X6DHE-G2. All have an onboard System Hardware Monitor chip that supports PC health monitoring.

Onboard Voltage Monitors for the CPU Cores, Chipset Voltage, +3.3V, +5V, +12V and +3.3V Standby

An onboard voltage monitor will scan these voltages continuously. Once a voltage becomes unstable, a warning is given or an error message is sent to the screen. Users can adjust the voltage thresholds to define the sensitivity of the voltage monitor.

Fan Status Monitor with Firmware Control

The PC health monitor can check the RPM status of the cooling fans. The onboard CPU and chassis fans are controlled by Thermal Management via BIOS (under Hardware Monitoring in the Advanced Setting).

Environmental Temperature Control

The thermal control sensor monitors the CPU temperature in real time and will turn on the thermal control fan whenever the CPU temperature exceeds a user-defined threshold. The overheat circuitry runs independently from the CPU. Once it detects that the CPU temperature is too high, it will automatically turn on the thermal fan control to prevent any overheat damage to the CPU. The onboard chassis thermal circuitry can monitor the overall system temperature and alert users when the chassis temperature is too high.

CPU Fan Auto-Off in Sleep Mode

The CPU fan activates when the power is turned on. It continues to operate when the system enters Standby mode. When in sleep mode, the CPU will not run at full power, thereby generating less heat.

CPU Overheat LED and Control

This feature is available when the user enables the CPU overheat warning function in the BIOS. This allows the user to define an overheat temperature. When this temperature is exceeded, both the overheat fan and the warning LED are triggered.

System Resource Alert

This feature is available when used with Supero Doctor III in the Windows OS environment or used with Supero Doctor II in Linux. SDIII is used to notify the user of certain system events. For example, if the system is running low on virtual memory and there is insufficient hard drive space for saving the data, you can be alerted of the potential problem.

1-5 ACPI Features

ACPI stands for Advanced Configuration and Power Interface. The ACPI specification defines a flexible and abstract hardware interface that provides a standard way to integrate power management features throughout a PC system, including its hardware, operating system and application software. This enables the system to automatically turn on and off peripherals such as CD-ROMs, network cards, hard disk drives and printers. This also includes consumer devices connected to the PC such as VCRs, TVs, telephones and stereos.

In addition to enabling operating system-directed power management, ACPI provides a generic system event mechanism for Plug and Play and an operating system-independent interface for configuration control. ACPI leverages the Plug and Play BIOS data structures while providing a processor architecture-independent implementation that is compatible with both Windows 2000 and Windows NT 5.0.

Microsoft OnNow

The OnNow design initiative is a comprehensive, system-wide approach to system and device power control. OnNow is a term for a PC that is always on but appears to be off and responds immediately to user or other requests.

Slow Blinking LED for Suspend-State Indicator

When the CPU goes into a suspend state, the chassis power LED will start blinking to indicate that the CPU is in suspend mode. When the user presses any key, the CPU will wake-up and the LED will automatically stop blinking and remain on.

Main Switch Override Mechanism

When an ATX power supply is used, the power button can function as a system suspend button to make the system enter a SoftOff state. The monitor will be suspended and the hard drive will spin down. Depressing the power button again will cause the whole system to wake-up. During the SoftOff state, the ATX power supply provides power to keep the required circuitry in the system alive. In case the system malfunctions and you want to turn off the power, just depress and hold the power button for 4 seconds. This option can be set in the Power section of the BIOS Setup routine.

External Modem Ring-On

Wake-up events can be triggered by a device such as the external modem ringing when the system is in the SoftOff state. Note that external modem ring-on can only be used with an ATX 2.01 (or above) compliant power supply.

Wake-On-LAN (WOL)

Wake-On-LAN is defined as the ability of a management application to remotely power up a computer that is powered off. Remote PC setup, updates and asset tracking can occur after hours and on weekends so that daily LAN traffic is kept to a minimum and users are not interrupted. The motherboard has a 3-pin header (WOL) to connect to the 3-pin header on a

Network Interface Card (NIC) that has WOL capability. Wake-On-LAN must be enabled in BIOS. Note that Wake-On-LAN can only be used with an ATX 2.01 (or above) compliant power supply.

1-6 Power Supply

As with all computer products, a stable power source is necessary for proper and reliable operation. It is even more important for processors that have high CPU clock rates.

The X6DH8-G2/X6DHE-G2 can only accommodate 24-pin ATX power supplies. Although most power supplies generally meet the specifications required by the CPU, some are inadequate. You should use one that will supply at least 400W of power connector. In addition, the 12V 4-pin power supply (J32) - is also required to ensure adequate power supply to the system. Also your power supply must supply 1.5A for the Ethernet ports.

NOTE: The + 12V 8-pin Aux. Power Connector (J1D1) is also required to support Intel Xeon CPUs. Failure to provide this extra power will result in CPU PWR Failure. See Section 2-5 for details on connecting the power supply.

It is strongly recommended that you use a high quality power supply that meets ATX power supply Specification 2.02 or above. It must also be SSI compliant (info at <http://www.ssiforum.org/>). Additionally, in areas where noisy power transmission is present, you may choose to install a line filter to shield the computer from noise. It is recommended that you also install a power surge protector to help avoid problems caused by power surges.

1-7 Super I/O

The disk drive adapter functions of the Super I/O chip include a floppy disk drive controller that is compatible with industry standard 82077/765, a data separator, write pre-compensation circuitry, decode logic, data rate selection, a clock generator, drive interface control logic and interrupt and DMA logic. The wide range of functions integrated onto the Super I/O greatly reduces the number of components required for interfacing with floppy disk drives. The Super I/O supports 360 K, 720 K, 1.2 M, 1.44 M or 2.88 M disk drives and data transfer rates of 250 Kb/s, 500 Kb/s or 1 Mb/s. It also provides two high-speed, 16550 compatible serial communication ports (UARTs), one of which supports serial infrared communication. Each UART includes a 16-byte send/receive FIFO, a programmable baud rate generator,

complete modem control capability and a processor interrupt system. Both UARTs provide legacy speed with baud rate of up to 115.2 Kbps as well as an advanced speed with baud rates of 250 K, 500 K, or 1 Mb/s, which support higher speed modems.

The Super I/O supports one PC-compatible printer port (SPP), Bi-directional Printer Port (BPP) , Enhanced Parallel Port (EPP) or Extended Capabilities Port (ECP).

The Super I/O provides functions that comply with ACPI (Advanced Configuration and Power Interface), which includes support of legacy and ACPI power management through an SMI or SCI function pin. It also features auto power management to reduce power consumption.

The IRQs, DMAs and I/O space resources of the Super I/O can flexibly adjust to meet ISA PnP requirements, which support ACPI and APM (Advanced Power Management).

Chapter 2 Installation

2-1 Static-Sensitive Devices

Electric-Static-Discharge (ESD) can damage electronic components. To prevent damage to your system board, it is important to handle it very carefully. The following measures are generally sufficient to protect your equipment from ESD.

Precautions

- Use a grounded wrist strap designed to prevent static discharge.
- Touch a grounded metal object before removing the board from the anti-static bag.
- Handle the board by its edges only; do not touch its components, peripheral chips, memory modules or gold contacts.
- When handling chips or modules, avoid touching their pins.
- Put the motherboard and peripherals back into their antistatic bags when not in use.
- For grounding purposes, make sure your computer chassis provides excellent conductivity between the power supply, the case, the mounting fasteners and the motherboard.
- Use only the correct type of onboard CMOS battery. Do not install the onboard upside down battery to avoid possible explosion.

Unpacking

The motherboard is shipped in antistatic packaging to avoid static damage. When unpacking the board, make sure the person handling it is static protected.

2-2 Nocona Processor and Heatsink Installation



When handling the processor package, avoid placing direct pressure on the label area of the fan. Also, do not place the motherboard on a conductive surface, which can damage the BIOS battery and prevent the system from booting up.

IMPORTANT: Always connect the power cord last and always remove it before adding, removing or changing any hardware components. Make sure that you install the processor into the CPU socket **before** you install the CPU (CEK) heat sink. To adequately support the weight of CPU heat sinks, please install the X6DH8-G2/X6DHE-G2 in a chassis that is compliant with the SSI EEB 3.5 Specification.

CPU Installation

1. Lift the lever on the CPU socket: lift the lever completely as shown on the picture on the right; otherwise, you will damage the CPU socket when power is applied. (Install CPU1 first.)



Socket lever

2. Insert the CPU in the socket, making sure that pin 1 of the CPU aligns with pin 1 of the socket (both corners are marked with a triangle). When using only one CPU, install it into CPU socket #1 (socket #2 is automatically disabled if only one CPU is used).

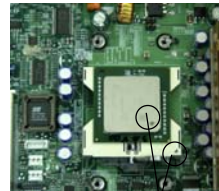

Pin1

3. Press the lever down until you hear the *click* so you can be sure that the CPU is securely installed in the CPU socket.



Socket lever in the locking Position

CEK Heatsink Installation

IMPORTANT: Due to the weight of the CEK Passive Heatsink (which weights about 1KG), you need to have Heatsink Mounting plate installed on the chassis to prevent damage to the CPU and the motherboard)

1. Do not apply any thermal compound to the heatsink or the CPU die-the required amount has already been applied.
2. Place the heatsink on top of the CPU so that the four mounting holes are aligned with those on the retention mechanism.



3. Screw in two diagonal screws (ie the #1 and the #2 screws) until just snug (-do not fully tighten the screws to avoid possible damage to the CPU.)
4. Finish the installation by fully tightening all four screws.

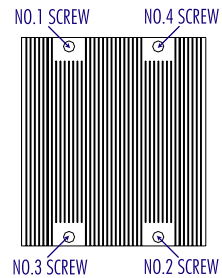
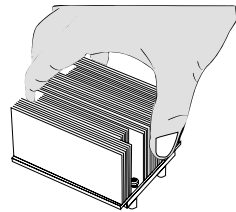

To Un-install the Heatsink

(Caution! We do not recommend that the CPU or the heatsink be removed. However, if you do need to un-install the heatsink, please follow the instructions below to uninstall the heatsink to prevent damage done to the CPU or the CPU socket.)

1. Unscrew and remove the heatsink screws from the motherboard in the sequence as show in the picture on the right.

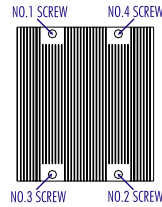

2. Hold the heatsink as show in the picture on the right and gently wriggle the heatsink to loosen it from the CPU. (Do not use excessive force when wriggling the heatsink!!)

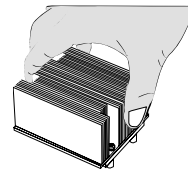

3. Once the CPU is loosened, remove the heatsink from the CPU socket.

4. Clean the surface of the CPU and the heatsink to get rid of the old thermal grease. Reapply the proper amount of thermal grease on the surface before you re-install the CPU and the heatsink.

Figure 2-1. PGA604 Socket: Empty and with Processor Installed

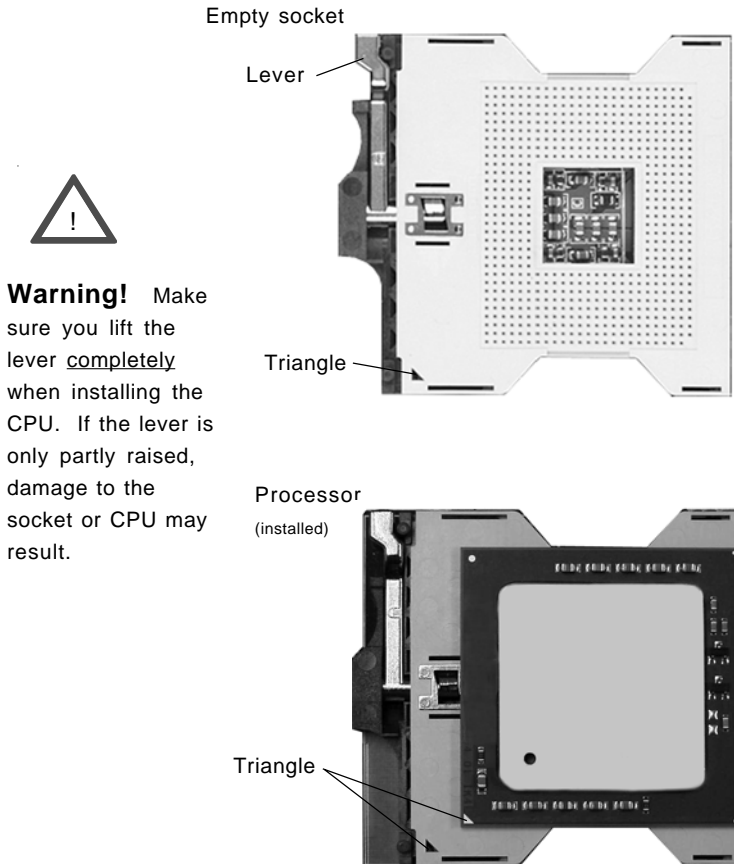

Mounting the Motherboard in the Chassis

All motherboards have standard mounting holes to fit different types of chassis. Make sure the location of all the mounting holes for both the motherboard and the chassis match. Although a chassis may have both plastic and metal mounting fasteners, metal ones are highly recommended because they ground the motherboard to the chassis. Make sure the metal standoffs click in or are screwed in tightly. Then use a screwdriver to secure the motherboard onto the motherboard tray.

2-3 Installing DIMMs

Note: Check the Supermicro web site for recommended memory modules:
http://www.supermicro.com/TECHSUPPORT/FAQs/Memory_vendors.htm

CAUTION

Exercise extreme care when installing or removing DIMM modules to prevent any possible damage. Also note that the memory is interleaved to improve performance (see step 1).

DIMM Installation (See Figure 2-2)

1. Insert the desired number of DIMMs into the memory slots, starting with Bank 1. The memory scheme is interleaved so you must install two modules at a time, beginning with Bank 1, then Bank 2, and so on.
2. Insert each DIMM module vertically into its slot. Pay attention to the notch along the bottom of the module to prevent inserting the DIMM module incorrectly.
3. Gently press down on the DIMM module until it snaps into place in the slot. Repeat for all modules (see step 1 above).

Memory Support

The X6DH8-G2/X6DHE-G2 supports up to 16 GB of Registered ECC DDR2-400 (PC3200) memory. All motherboards were designed to support 2 GB modules in each slot, but has only been verified for up to 1 GB modules.

Figure 2-2. Installing and Removing DIMMs

To Install:
 Insert module vertically and press down until it snaps into place. Pay attention to the alignment notch at the bottom.

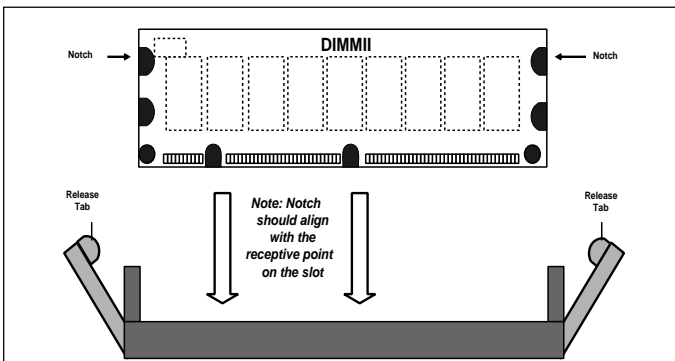

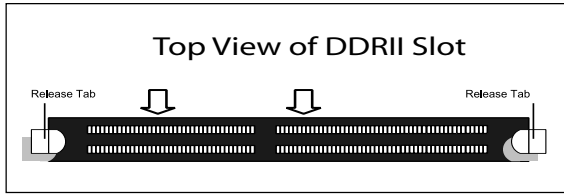
**To Remove:**

Use your thumbs to gently push near the edge of both ends of the module. This should release it from the slot.

2-4 I/O Ports/Control Panel Connectors

The I/O ports are color coded in conformance with the PC 99 specification. See Figure 2-3 below for the colors and locations of the various I/O ports.

Figure 2-3. I/O Port Locations and Definitions

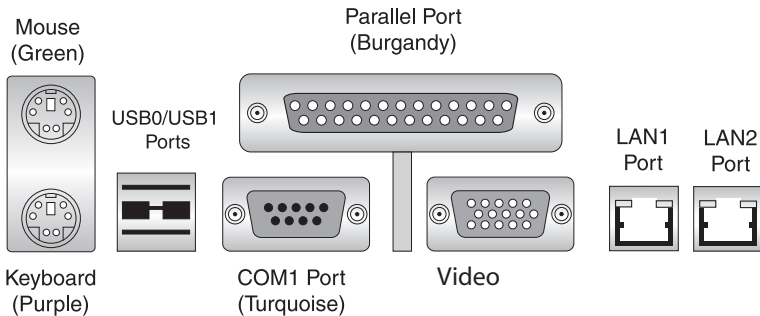

Front Control Panel

JF1 contains header pins for various buttons and indicators that are normally located on a control panel at the front of the chassis. These connectors are designed specifically for use with Supermicro server chassis. See Figure 2-4 for the descriptions of the various control panel buttons and LED indicators. Refer to the following section for descriptions and pin definitions.

Figure 2-4. JF1 Header Pins

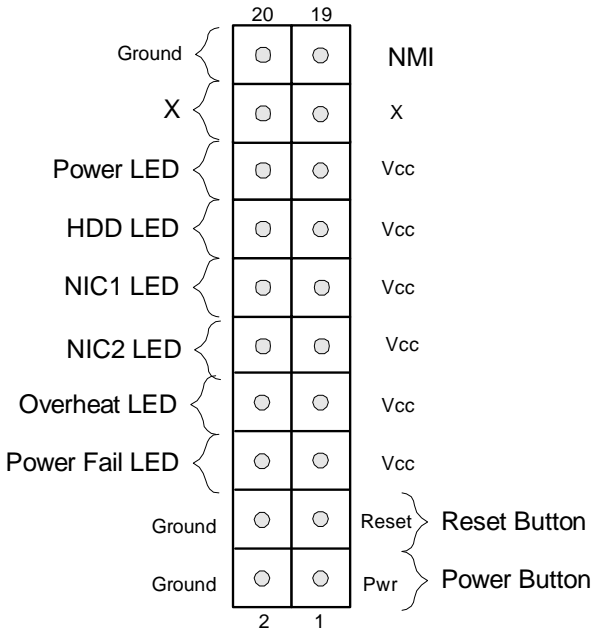

2-5 Connecting Cables

ATX Power Connector

The main power supply connector on the X6DH8-G2/X6DHE-G2 meets the SSI (Superset ATX) 24-pin specification. You must also connect the 4-pin (J32) power connector to your power supply. See the table on the right for pin definitions.

ATX Power Supply 24-pin Connector
Pin Definitions

Pin Number	Definition	Pin Number	Definition
13	+3.3V	1	+3.3V
14	-12V	2	+3.3V
15	COM	3	COM
16	PS_ON#	4	+5V
17	COM	5	COM
18	COM	6	+5V
19	COM	7	COM
20	Res(NC)	8	PWR_OK
21	+5V	9	5VSB
22	+5V	10	+12V
23	+5V	11	+12V
24	COM	12	+3.3V

+12V 4-pin
Connector
(J32)

Pins #	Definition
1 & 2	Ground
3 & 4	+12 V

Processor Power Connector

In addition to the Primary ATX power connector (above), the 12v 8-pin Processor connector at J1D1 must also be connected to your power supply.

8-Pin +12v Power Supply
Connector (J1D1)

Pins	Definition
1 thru 4	Ground
5 thru 8	+12v

Aux. PWR Connector ATX PWR Connector CPU PWR Connector

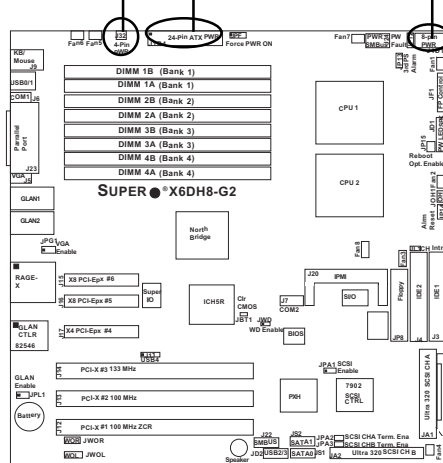

NMI Button

The non-maskable interrupt button header is located on pins 19 and 20 of JF1. Refer to the table on the right for pin definitions.

NMI Button Pin Definitions (JF1)

Pin Number	Definition
19	Control
20	Ground

Power LED

The Power LED connection is located on pins 15 and 16 of JF1. Refer to the table on the right for pin definitions.

PWR_LED Pin Definitions (JF1)

Pin Number	Definition
15	Vcc
16	Control

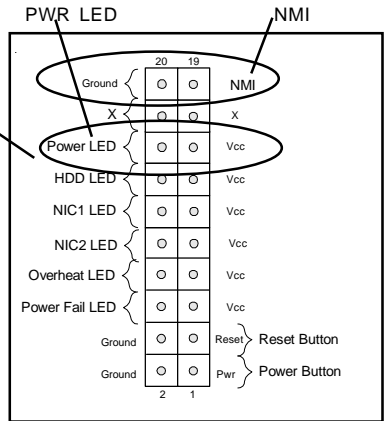
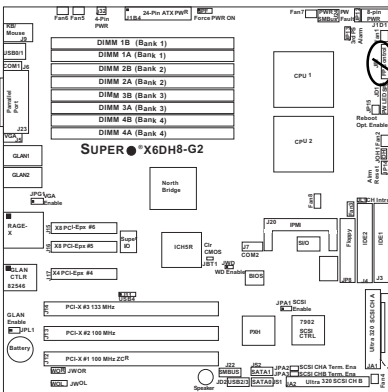

HDD LED

The HDD LED connection is located on pins 13 and 14 of JF1. Attach the hard drive LED cable here to display disk activity (for any hard drives on the system, including SCSI, Serial ATA and IDE). See the table on the right for pin definitions.

HDD LED Pin Definitions (JF1)

Pin Number	Definition
13	Vcc
14	HD Active

NIC1/NIC2 LED Indicators

The NIC (Network Interface Controller) LED connections for the GLAN port1 is located on pins 11 and 12 of JF1, and for the GLAN port2 is located on pins 9 and 10 of JF1. Attach the NIC LED cables to display network activity. Refer to the tables on the right for pin definitions.

NIC1 LED Pin Definitions (JF1)

Pin Number	Definition
11	Vcc
12	GND

NIC2 LED Pin Definitions (JF1)

Pin Number	Definition
9	Vcc
10	GND

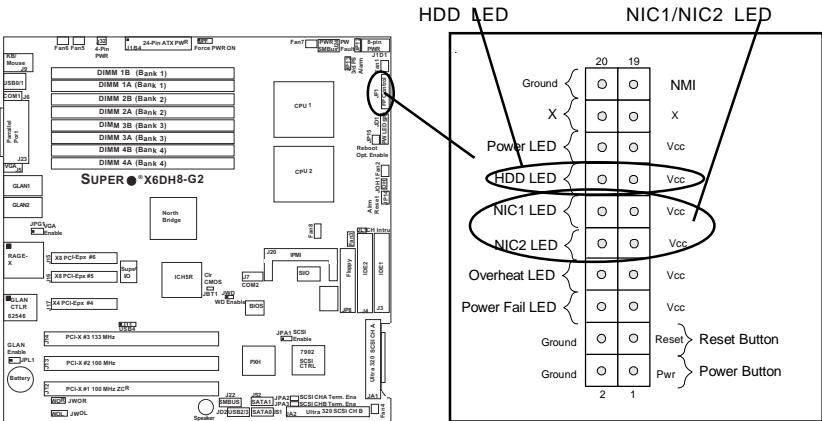

Overheat LED (OH)

Connect an LED to the OH connection on pins 7 and 8 of JF1 to provide advanced warning of chassis overheating. Refer to the table on the right for pin definitions.

**Overheat (OH) LED
Pin Definitions
(JF1)**

Pin Number	Definition
7	Vcc
8	Control Signal

Power Fail LED

The Power Fail LED connection is located on pins 5 and 6 of JF1. Refer to the table on the right for pin definitions.

**Overheat (OH) LED
Pin Definitions
(JF1)**

Pin Number	Definition
5	Vcc
6	Control Signal

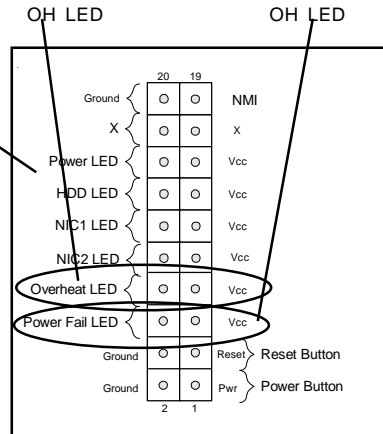
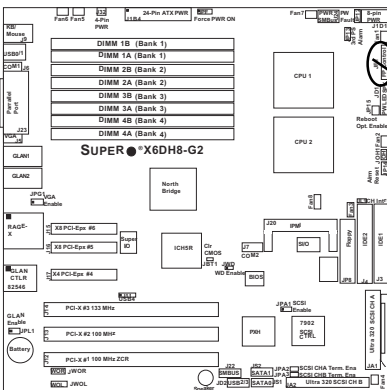

Reset Button

The Reset Button connection is located on pins 3 and 4 of JF1. Attach it to the hardware reset switch on the computer case. Refer to the table on the right for pin definitions.

Reset Pin Definitions (JF1)

Pin Number	Definition
3	Reset
4	Ground

Power Button

The Power Button connection is located on pins 1 and 2 of JF1. Momentarily contacting both pins will power on/off the system.

Power Button Connector Pin Definitions (JF1)

Pin Number	Definition
1	PW_ON
2	Ground

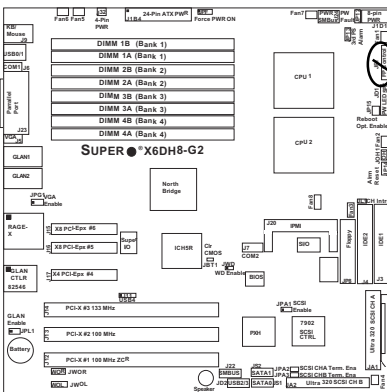

PWR Button

Reset Button

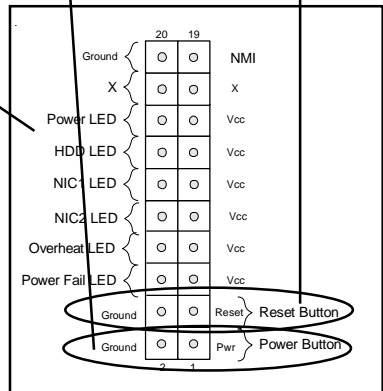

Chassis Intrusion

A Chassis Intrusion header is located at JL1. Attach the appropriate cable to inform you of a chassis intrusion.

Universal Serial Bus (USB0/1)

Two USB 2.0 ports are located beside the PS/2 keyboard/mouse ports. USB0 is the bottom connector and USB1 is the top connector. See the table on the right for pin definitions.

Universal Serial Bus Pin Definitions
USB0/1

Pin Number	Definition
1	Vcc
2	Data-
3	Data+
4	Ground

USB0/1

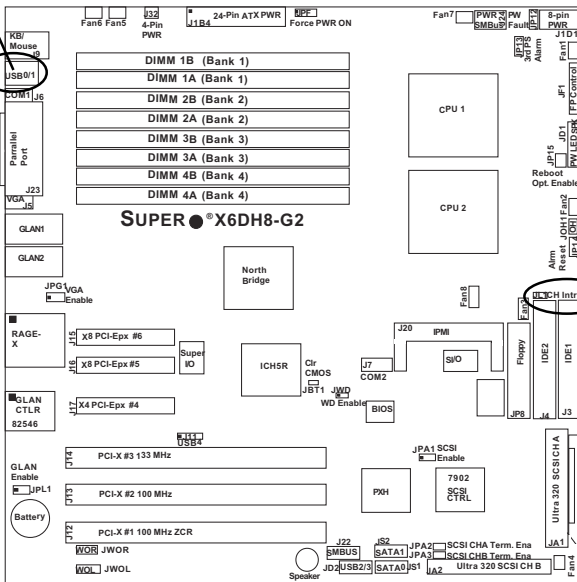

Chassis Intrusion

Front Panel Universal Serial Bus Headers

Extra USB headers (FPUSB2/FPUSB3/FPUSB4) can be used for front side USB access. You will need a USB cable to use either connection. Refer to the tables on the right for pin definitions.

Front Panel Universal Serial Bus Pin Definitions

FPUSB2/FPUSB3

Pin Number	Definition	Pin Number	Definition
1	Vcc	2	Vcc
3	Data-	4	Data-
5	Data+	6	Data+
7	Ground	8	Ground
9	Key	10	NA

Universal Serial Bus Pin Definitions FP USB4

Pin Number	Definition
1	Vcc
2	Data-
3	Data+
4	Ground
5	NA

Serial Ports

The COM1 (J6) and COM2 (J7) serial ports are located under the parallel port (COM1) and next to IPMI (COM2). See the table on the right for pin definitions.

Serial Port Pin Definitions (COM1)

Pin Number	Definition	Pin Number	Definition
1	DCD	6	DSR
2	RXD	7	RTS
3	TXD	8	CTS
4	DTR	9	RI
5	GND		

Serial Port Pin Definitions (COM2)

Pin Number	Definition	Pin Number	Definition
1	DCD	6	DSR
2	RXD	7	RTS
3	TXD	8	CTS
4	DTR	9	RI
5	GND	10	NC

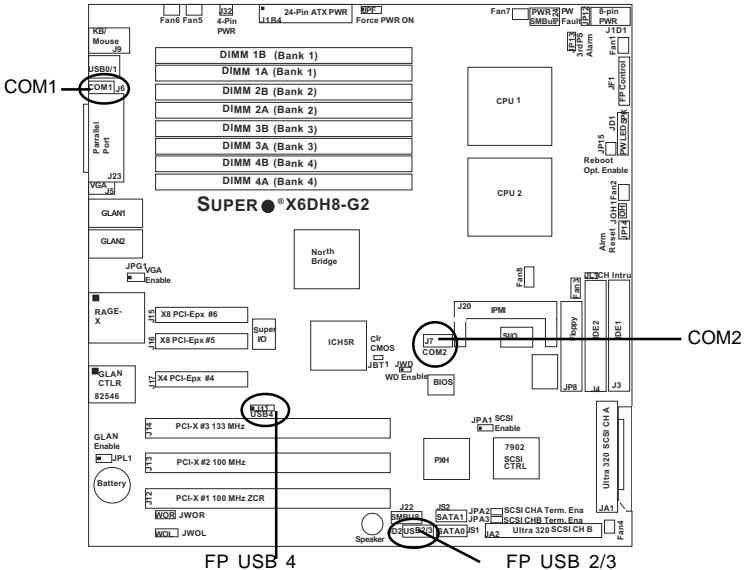

GLAN (Giga-bit Ethernet Ports)



Two G-bit Ethernet ports are located beside the COM2 port on the IO backplane. This port accepts RJ45 type cables.

ATX PS/2 Keyboard and PS/2 Mouse Ports

The ATX PS/2 keyboard and PS/2 mouse are located on J9. See the table at right for pin definitions. (See Figure 2-3 for the locations of each.)

PS/2 Keyboard and Mouse Port Pin Definitions (J9)

Pin Number	Definition
1	Data
2	NC
3	Ground
4	VCC
5	Clock
6	NC

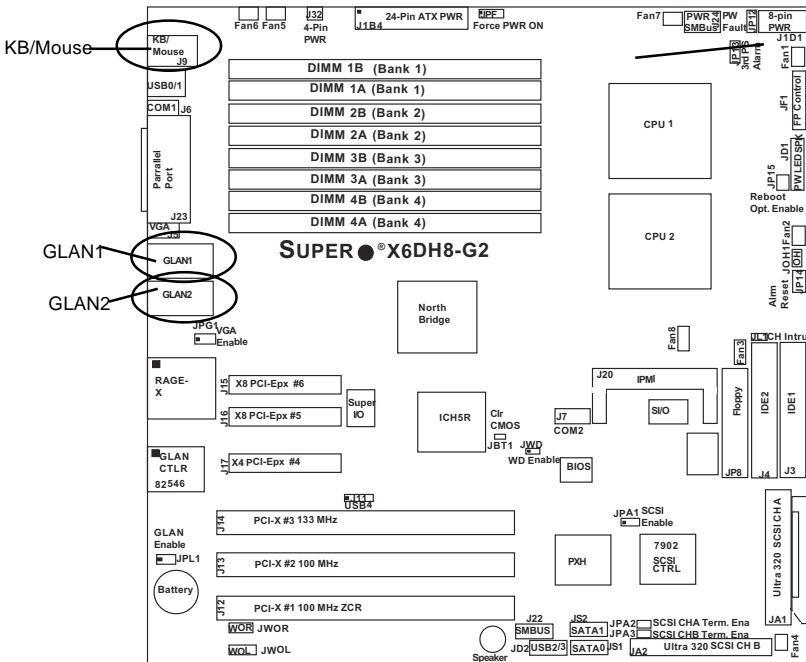

Fan Headers

The X6DH8-G2/X6DHE-G2 has eight fan headers (Fan1 to Fan8). Fan1-Fan4 are 3-pin fans, and Fan5-Fan8 are 4-pin fans. (* Note: Fan5-Fan8 are 4-pin fan headers; however, Pins 1-3 of these fan headers are backward compatible with the traditional 3-pin fans.) See the table on the right for pin definitions. (*The onboard fan speed is controlled by Thermal Management via BIOS. To activate Fan Speed Control, please refer to "Hardware Monitoring" in the Advanced Setting.)

4-pin Fan Header Pin Definitions

Pin#	Definition
1	Ground
2	+12V
3	Tachometer
4	PWM_Control

Caution: These fan headers use DC power.

Power LED/Speaker

On the JDI header, pins 1-3 are for a power LED and pins 4-7 are for the speaker. See the table on the right for speaker pin definitions. Note: The speaker connector pins are for use with an external speaker. If you wish to use the onboard speaker, you should close pins 6-7 with a jumper.

Speaker Connector Pin Definitions (JD1)

Pin Number	Function	Definition
4	+	Power
5	Key	No connection
6		Key
7		Speaker data

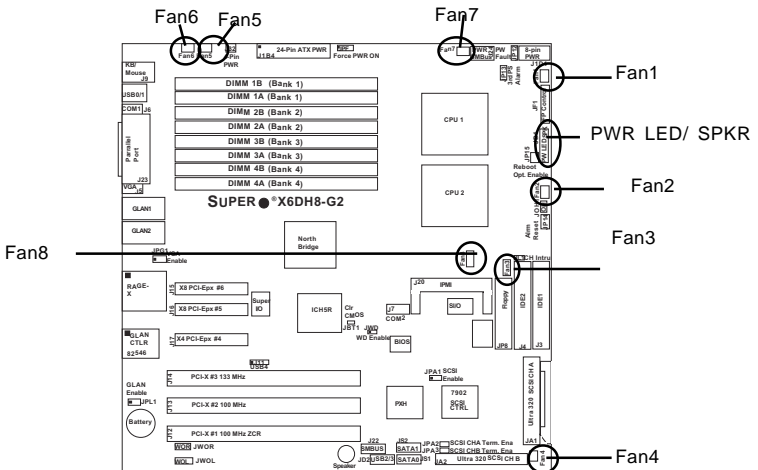

Wake-On-Ring

The Wake-On-Ring header is designated JWOR. This function allows your computer to receive and "wake-up" by an incoming call to the modem when in suspend state. See the table on the right for pin definitions. You must have a Wake-On-Ring card and cable to use this feature.

Wake-on-Ring Pin Definitions (JWOR)

Pin Number	Definition
1	Ground
2	Wake-up

Wake-On-LAN

The Wake-On-LAN header is designated WOL. See the table on the right for pin definitions. You must enable the LAN Wake-Up setting in BIOS to use this feature. You must also have a LAN card with a Wake-on-LAN connector and cable.

Wake-On-LAN Pin Definitions (JWOL)

Pin Number	Definition
1	+5V Standby
2	Ground
3	Wake-up

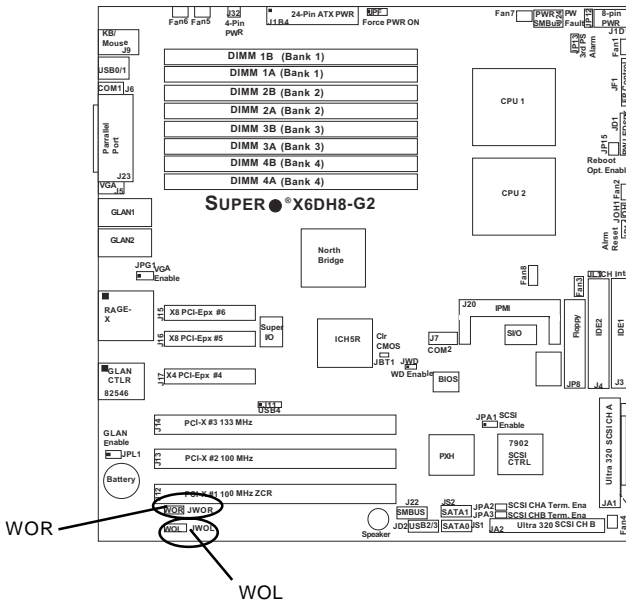

SMB

A System Management Bus header is located at J22. Connect the appropriate cable here to utilize SMB on your system.

Fan Header Pin Definitions (J22)

Pin Number	Definition
1	Data
2	GND
3	CLK
4	NC

Caution: These fan headers are DC power.

SMB Power (I²C) Connector

I²C Connector (J24), located between the PWR ForceOn Header and the PWR Fault header, monitors the status of PWR Supply, Fan and system temperature.

SMB PWR Pin Definitions (J24)

Pin #	Definition
1	Clock
2	Data
3	N/A
4	N/A
5	N/A

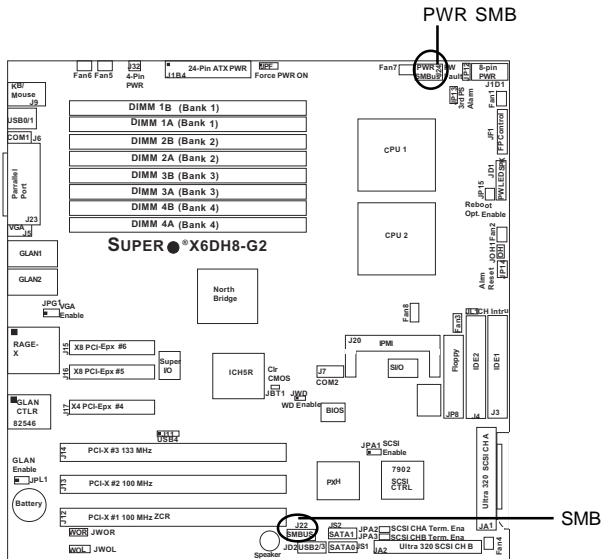

2-6 Jumper Settings

Explanation of Jumpers

To modify the operation of the motherboard, jumpers can be used to choose between optional settings. Jumpers create shorts between two pins to change the function of the connector. Pin 1 is identified with a square solder pad on the printed circuit board. See the motherboard layout pages for jumper locations.

Note: On two pin jumpers, "Closed" means the jumper is on and "Open" means the jumper is off the pins.

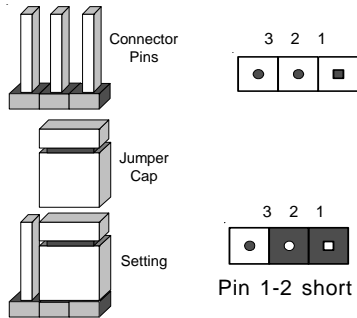

GLAN Enable/Disable

JPL1 enables or disables the GLAN port(s) on the motherboard. See the table on the right for jumper settings. The default setting is enabled.

GLAN Enable/Disable Jumper Settings (JPL1)

Jumper Position	Definition
Pins 1-2	Enabled
Pins 2-3	Disabled

GLAN Enable

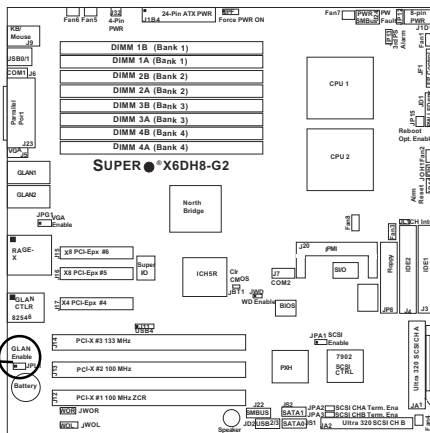

CMOS Clear

JBT1 is used to clear CMOS. Instead of pins, this "jumper" consists of contact pads to prevent the accidental clearing of CMOS. To clear CMOS, use a metal object such as a small screwdriver to touch both pads at the same time to short the connection. Always remove the AC power cord from the system before clearing CMOS.

Note: For an ATX power supply, you must completely shut down the system, remove the AC power cord and then short JBT1 to clear CMOS. Do not use the PW ON connector to clear CMOS.

Watch Dog

JWD controls Watch Dog, a system monitor that takes action when a software application freezes the system. Pins 1-2 will have WD reset the system if a program freezes. Pins 2-3 will generate a non-maskable interrupt for the program that has frozen (requires software implementation). Watch Dog must also be enabled in BIOS.

**Watch Dog
Jumper Settings (JWD)**

Jumper Position	Definition
Pins 1-2	WD to Reset
Pins 2-3	WD to NMI
Open	Disabled

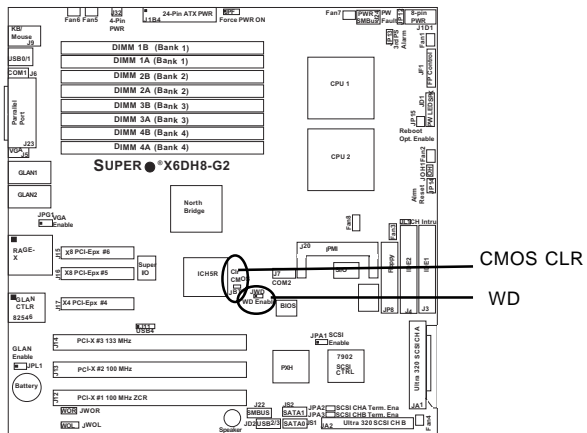

VGA Enable/Disable

JPG1 enables or disables the VGA Connector on the motherboard. See the table on the right for jumper settings. The default setting is enabled.

VGA Enable/Disable Jumper Settings (JPG1)

Jumper Position	Definition
Pins 1-2	Enabled
Pins 2-3	Disabled

Alarm Reset

The system will notify you in the event of a power supply failure. This feature assumes that Supermicro redundant power supply units are installed in the chassis. If you only have a single power supply installed, please do not connect anything to this header to prevent false alarms. See the table on the right for jumper settings.

Alarm Reset Jumper Settings (JP14)

Jumper Position	Definition
Open	Normal
Closed	Reset Alarm

Alarm Reset

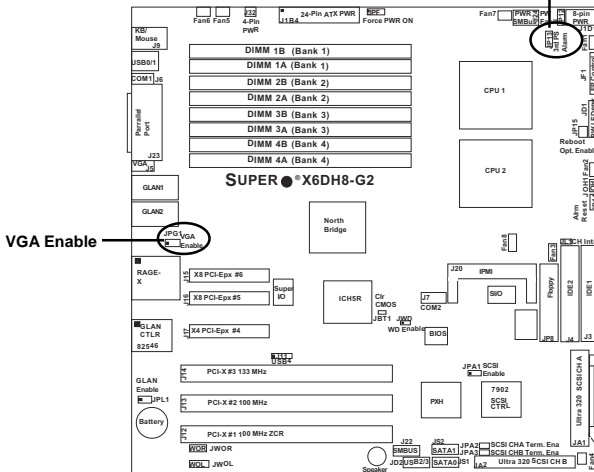

Power Fault

Connect a cable from your power supply to JP12 to provide warning of power supply failure. This warning signal is passed through the PWR_LED pin to indicate of a power failure on the chassis. See the table on the right for pin definitions.

Alarm Reset Jumper Settings (JP12)

Jumper Position	Definition
1	PWR#1
2	PWR#2
3	PWR#3
4	Signal: Alarm Reset

Power Fault

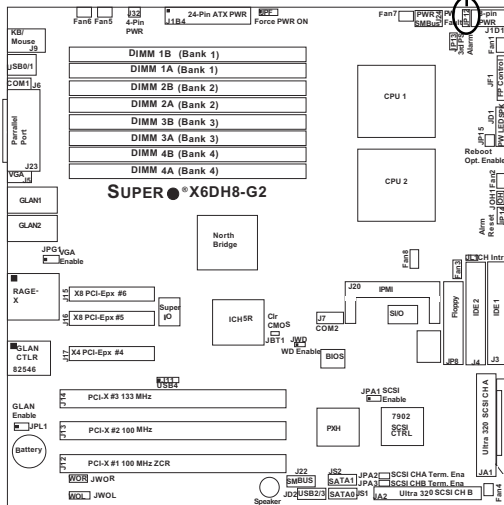

**SCSI Enable/Disable
(*ForX6DH8 only)**

Jumper JPA1 allows you to enable or disable the SCSI headers. Jumper JPA1 is for headers #1 and #2. The default setting is pins 1-2 to enable all four headers. See the table on the right for jumper settings.

**SCSI Enable/Disable
Jumper Settings
(JPA1)**

Jumper Position	Definition
Pins 1-2	Enabled
Pins 2-3	Disabled

**SCSI CH A/B Termination
Enable/Disable (*ForX6DH8
only)**

Jumpers JPA2 and JPA3 allow you to enable or disable termination for the SCSI connectors. Jumper JPA2 controls SCSI channel A and JPA3 is for SCSI channel B. The default setting is open to enable (terminate) both SCSI channels. **(*Note: the manufacture default setting is "Open". For SCSI to function properly, please do not change the default setting.)** See the table on the right for jumper settings.

**SCSI Channel Termination
Enable/Disable
Jumper Settings
(JPA2, JPA3)**

Jumper Position	Definition
Open	Enabled
Closed	Disabled

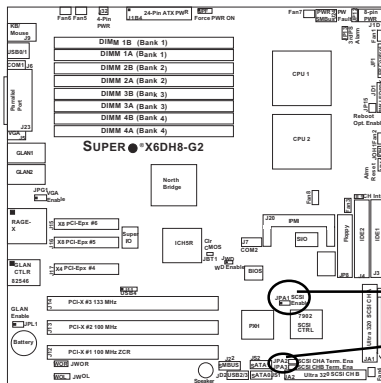

SCSI Enable
SCSI CH A/B
Term. Enable

2-8 Parallel Port, Floppy/Hard Disk Drive and SCSI Connections

Note the following when connecting the floppy and hard disk drive cables:

- The floppy disk drive cable has seven twisted wires.
- A red mark on a wire typically designates the location of pin 1.
- A single floppy disk drive ribbon cable has 34 wires and two connectors to provide for two floppy disk drives. The connector with twisted wires always connects to drive A, and the connector that does not have twisted wires always connects to drive B.

Parallel (Printer) Port Connector

The parallel (printer) port is located on J23. See the table on the right for pin definitions.

Parallel (Printer) Port Pin Definitions (J23)

Pin Number	Function	Pin Number	Function
1	Strobe-	2	Auto Feed-
3	Data Bit 0	4	Error-
5	Data Bit 1	6	Init-
7	Data Bit 2	8	SLCT IN-
9	Data Bit 3	10	GND
11	Data Bit 4	12	GND
13	Data Bit 5	14	GND
15	Data Bit 6	16	GND
17	Data Bit 7	18	GND
19	ACK	20	GND
21	BUSY	22	GND
23	PE	24	GND
25	SLCT		

Parallel Port

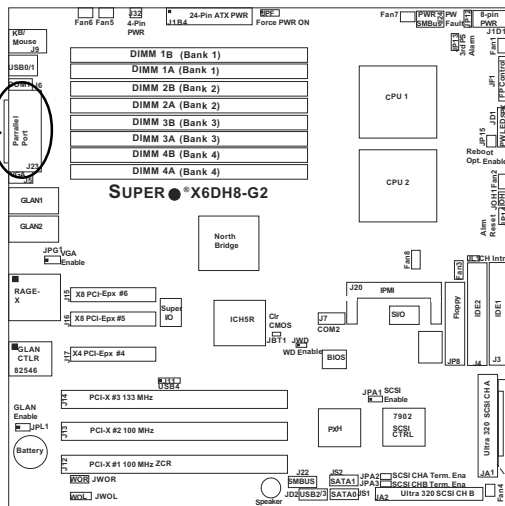

Floppy Connector

The floppy connector is located on JP8. See the table below for pin definitions.

Floppy Connector Pin Definitions (JP8)

Pin Number	Function	Pin Number	Function
1	GND	2	FDHDIN
3	GND	4	Reserved
5	Key	6	FDEDIN
7	GND	8	Index-
9	GND	10	Motor Enable
11	GND	12	Drive Select B-
13	GND	14	Drive Select A-
15	GND	16	Motor Enable
17	GND	18	DIR-
19	GND	20	STEP-
21	GND	22	Write Data-
23	GND	24	Write Gate-
25	GND	26	Track 00-
27	GND	28	Write Protect-
29	NC	30	Read Data-
31	GND	32	Side 1 Select-
33	NC	34	Diskette

IDE Connectors

There are no jumpers to configure the onboard IDE#1 and #2 connectors (at J3 and J4, respectively). See the table on the right for pin definitions.

IDE Connector Pin Definitions (J3, J4)

Pin Number	Function	Pin Number	Function
1	Reset IDE	2	GND
3	Host Data 7	4	Host Data 8
5	Host Data 6	6	Host Data 9
7	Host Data 5	8	Host Data 10
9	Host Data 4	10	Host Data 11
11	Host Data 3	12	Host Data 12
13	Host Data 2	14	Host Data 13
15	Host Data 1	16	Host Data 14
17	Host Data 0	18	Host Data 15
19	GND	20	Key
21	DRQ3	22	GND
23	I/O Write-	24	GND
25	I/O Read-	26	GND
27	IOCHRDY	28	BALE
29	DACK3-	30	GND
31	IRQ14	32	NC
33	Addr 1	34	GND
35	Addr 0	36	Addr 2
37	Chip Select 0	38	Chip Select 1-
39	Activity	40	GND

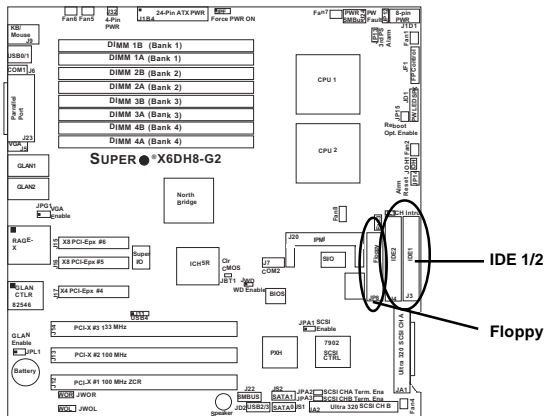

Ultra320 SCSI Connectors (*X6DH8-G2 Only)

Refer to the table below for the pin definitions of the Ultra320 SCSI connectors located at JA1 and JA2.

68-pin Ultra320 SCSI Connectors (JA1 and JA2)

Connector Contact Number	Signal Names	Connector Contact Number	Signal Names
1	+DB(12)	35	-DB(12)
2	+DB(13)	36	-DB(13)
3	+DB(14)	37	-DB(14)
4	+DB(15)	38	-DB(15)
5	+DB(P1)	39	-DB(P1)
6	+DB(0)	40	-DB(0)
7	+DB(1)	41	-DB(1)
8	+DB(2)	42	-DB(2)
9	+DB(3)	43	-DB(3)
10	+DB(4)	44	-DB(4)
11	+DB(5)	45	-DB(5)
12	+DB(6)	46	-DB(6)
13	+DB(7)	47	-DB(7)
14	+DB(P)	48	-DB(P)
15	GROUND	49	GROUND
16	DIFFSENS	50	GROUND
17	TERMPWR	51	TERMPWR
18	TERMPWR	52	TERMPWR
19	RESERVED	53	RESERVED
20	GROUND	54	GROUND
21	+ATN	55	-ATN
22	GROUND	56	GROUND
23	+BSY	57	-BSY
24	+ACK	58	-ACK
25	+RST	59	-RST
26	+MSG	60	-MSG
27	+SEL	61	-SEL
28	+C/D	62	-C/D
29	+REQ	63	-REQ
30	+I/O	64	-I/O
31	+DB(8)	65	-DB(8)
32	+DB(9)	66	-DB(9)
33	+DB(10)	67	-DB(10)
34	+DB(11)	68	-DB(11)

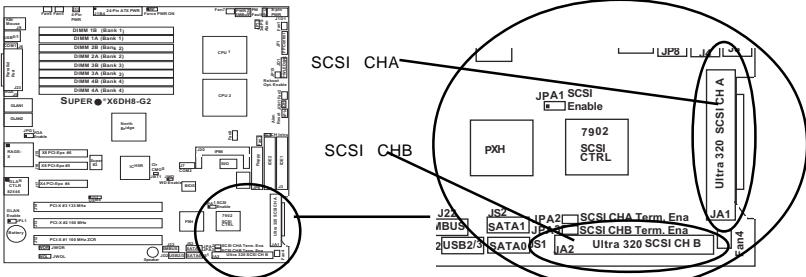

(*Note: Please refer to Appendix B for software and OS installation. For Adaptec's SCSI SATA HostRAID, please refer to the CD that came with your motherboard.)

Chapter 3

Troubleshooting

3-1 Troubleshooting Procedures

Use the following procedures to troubleshoot your system. If you have followed all of the procedures below and still need assistance, refer to the 'Technical Support Procedures' and/or 'Returning Merchandise for Service' section(s) in this chapter.

Note: Always disconnect the power cord before adding, changing or installing any hardware components.

Before Power On

1. Make sure no short circuits exist between the motherboard and chassis.
2. Disconnect all ribbon/wire cables from the motherboard, including those for the keyboard and mouse.
3. Remove all add-on cards.
4. Install one CPU (making sure it is fully seated) and connect the chassis speaker and the power LED to the motherboard. (Check all jumper settings as well.)
5. Use only the correct type of CMOS onboard battery as recommended by the Manufacturer. Do not install the onboard battery upside down to avoid possible explosion.

No Power

1. Make sure no short circuits exist between the motherboard and the chassis.
2. Verify that all jumpers are set to their default positions.
3. Check that the 115V/230V switch on the power supply is properly set.
4. Turn the power switch on and off to test the system.
5. The battery on your motherboard may be old. Check to verify that it still supplies ~3VDC. If it does not, replace it with a new one.

No Video

1. If the power is on but you have no video, remove all the add-on cards and cables.
2. Use the speaker to determine if any beep codes exist. Refer to the Appendix for details on beep codes.

NOTE

If you are a system integrator, VAR or OEM, a POST diagnostics card is recommended. For I/O port 80h codes, refer to App. B.

Memory Errors

1. Make sure the DIMM modules are properly and fully installed.
2. Determine if different speeds of DIMMs have been installed and verify that the BIOS setup is configured for the fastest speed of RAM used. It is recommended to use the same RAM speed for all DIMMs in the system.
3. Make sure you are using the correct type of Registered ECC DDR2-400 (PC3200) SDRAM (*recommended by the manufacturer.)
4. Check for bad DIMM modules or slots by swapping a single module between two slots and noting the results.
5. Make sure all memory modules are fully seated in their slots. As an interleaved memory scheme is used, you must install two modules at a time, beginning with Bank 1, then Bank 2, and so on (see Section 2-3).
6. Check the position of the 115V/230V switch on the power supply.

Losing the System's Setup Configuration

1. Ensure that you are using a high quality power supply. A poor quality power supply may cause the system to lose the CMOS setup information. Refer to Section 1-6 for details on recommended power supplies.
2. The battery on your motherboard may be old. Check to verify that it still supplies ~3VDC. If it does not, replace it with a new one.
3. If the above steps do not fix the Setup Configuration problem, contact your vendor for repairs.

3-2 Technical Support Procedures

Before contacting Technical Support, please take the following steps. Also, note that as a motherboard manufacturer, Super Micro does not sell directly to end-users, so it is best to first check with your distributor or reseller for troubleshooting services. They should know of any possible problem(s) with the specific system configuration that was sold to you.

1. Please go through the 'Troubleshooting Procedures' and 'Frequently Asked Question' (FAQ) sections in this chapter or see the FAQs on our web site (<http://www.supermicro.com/TECHSUPPORT/techsupport.htm>) before contacting Technical Support.
2. BIOS upgrades can be downloaded from our web site at <http://www.supermicro.com/techsupport/download.htm>.

Note: Not all BIOS can be flashed depending on the modifications to the boot block code.

3. If you still cannot resolve the problem, include the following information when contacting Super Micro for technical support:
 - Motherboard model and PCB revision number
 - BIOS release date/version (this can be seen on the initial display when your system first boots up)
 - System configurationAn example of a Technical Support form is on our web site at http://www.supermicro.com/techsupport/contact_support.htm.
4. Distributors: For immediate assistance, please have your account number ready when placing a call to our technical support department. We can be reached by e-mail at support@supermicro.com or by fax at: (408) 503-8000, option 2.

3-3 Frequently Asked Questions

Question: What are the various types of memory that my motherboard can support?

Answer: The X6DH8-G2/X6DHE-G2 has eight 240-pin DIMM slots that support registered ECC DDR2-400 (PC3200) SDRAM modules. It is strongly recommended that you do not mix memory modules of different speeds and sizes.

Question: How do I update my BIOS?

Answer: It is recommended that you **do not** upgrade your BIOS if you are experiencing no problems with your system. Updated BIOS files are located on our web site at <http://www.supermicro.com>. Please check our BIOS warning message and the info on how to update your BIOS on our web site. Also, check the current BIOS revision and make sure it is newer than your BIOS before downloading. Select your motherboard model and down-

load the BIOS file to your computer. Unzip the BIOS update file and you will find the readme.txt (flash instructions), the phlash.exe (BIOS flash utility), the platform.bin (platform file) and the BIOS image (xxxxxx.rom) files. Copy these files onto a bootable floppy and reboot your system. Follow the Readme.txt to continue flashing the BIOS.

Question: What's on the CD that came with my motherboard?

Answer: The supplied compact disc has quite a few drivers and programs that will greatly enhance your system. We recommend that you review the CD and install the applications you need. Applications on the CD include chipset drivers for Windows and security and audio drivers.

3-4 Returning Merchandise for Service

A receipt or copy of your invoice marked with the date of purchase is required before any warranty service will be rendered. You can obtain service by calling your vendor for a Returned Merchandise Authorization (RMA) number. When returning to the manufacturer, the RMA number should be prominently displayed on the outside of the shipping carton, and mailed prepaid or hand-carried. Shipping and handling charges will be applied for all orders that must be mailed when service is complete.

This warranty only covers normal consumer use and does not cover damages incurred in shipping or from failure due to the alternation, misuse, abuse or improper maintenance of products.

During the warranty period, contact your distributor first for any product problems.

Chapter 4

BIOS

4-1 Introduction

This chapter describes the Phoenix BIOS™ Setup utility for the X6DH8-G2/X6DHE-G2. The Phoenix ROM BIOS is stored in a flash chip and can be easily upgraded using a floppy disk-based program.

Note: Due to periodic changes to the BIOS, some settings may have been added or deleted and might not yet be recorded in this manual. Please refer to the Manual Download area of the Supermicro web site <<http://www.supermicro.com>> for any changes to BIOS that may not be reflected in this manual.

System BIOS

The BIOS is the Basic Input Output System used in all IBM® PC, XT™, AT®, and PS/2® compatible computers. The Phoenix BIOS flash chip stores the system parameters, such type of disk drives, video displays, etc. in the CMOS. The CMOS memory requires very little electrical power. When the computer is turned off, a backup battery provides power to the BIOS flash chip, enabling it to retain system parameters. Each time the computer is powered-on the computer is configured with the values stored in the BIOS ROM by the system BIOS, which gains control at boot-up.

How To Change the Configuration Data

The CMOS information that determines the system parameters may be changed by entering the BIOS Setup utility. This Setup utility can be accessed by pressing the <Delete> key at the appropriate time during system boot, see below.

Starting the Setup Utility

Normally, the only visible POST (Power On Self Test) routine is the memory test. As the memory is being tested, press the <Delete> key to enter the main menu of the BIOS Setup utility. From the main menu, you can access the other setup screens, such as the Security and Power menus. Beginning with Section 4-3, detailed descriptions are given for each parameter setting in the Setup utility.



Warning: Do not shut down or reset the system while updating BIOS to prevent possible boot failure.

4-2 Running Setup

**Default settings are in bold text unless otherwise noted.*

The BIOS setup options described in this section are selected by choosing the appropriate text from the main BIOS Setup screen. All displayed text is described in this section, although the screen display is often all you need to understand how to set the options (see on next page).

When you first power on the computer, the Phoenix BIOS™ is immediately activated.

While the BIOS is in control, the Setup program can be activated in one of two ways:

1. By pressing <Delete> immediately after turning the system on, or
2. When the message shown below appears briefly at the bottom of the screen during the POST (Power On Self-Test), press the <Delete> key to activate the main Setup menu:

Press the <Delete> key to enter Setup

4-3 Main BIOS Setup

All main Setup options are described in this section. The main BIOS Setup screen is displayed below.

Use the Up/Down arrow keys to move among the different settings in each menu. Use the Left/Right arrow keys to change the options for each setting.

Press the <Esc> key to exit the CMOS Setup Menu. The next section describes in detail how to navigate through the menus.

Items that use submenus are indicated with the ► icon. With the item highlighted, press the <Enter> key to access the submenu.

Main BIOS Setup Menu

PhoenixBIOS Setup - Copyright 1985-2001 Phoenix Technologies Ltd.		
Main Advanced Security Boot Exit		
System Time:	[11:42:57]	Item Specific Help <Tab>, <Shift-Tab>, or <Enter> selects field.
System Date:	[03-17-2004]	
BIOS Date		
Legacy Diskette A:	[1.44/1.25 MB 3½"]	
Parallel ATA:	[Both]	
Serial ATA:	[Enabled]	
SATA RAID Enable	[Disabled]	
Native Mode Operation:	[Auto]	
▶ IDE Channel 0 Master		
▶ IDE Channel 0 Slave		
▶ IDE Channel 1 Master		
▶ IDE Channel 1 Slave		
▶ IDE Channel 2 Master		
▶ IDE Channel 3 Master		
System Memory:	[XXXX KB]	
Extended Memory:	[XXXX KB]	
F1 Help ↑↓ Select Item -/+ Change Values F9 Setup Defaults		
Esc Exit ↔ Select Menu Enter Select ▶ Sub-Menu F10 Previous Values		

Main Setup Features

System Time

To set the system date and time, key in the correct information in the appropriate fields. Then press the <Enter> key to save the data.

System Date

Using the arrow keys, highlight the month, day and year fields and enter the correct data. Press the <Enter> key to save the data.

BIOS Date

This field displays the date when this version of BIOS was built.

Legacy Diskette A

This setting allows the user to set the type of floppy disk drive installed as diskette A. The options are Disabled, 360Kb 5.25 in, 1.2MB 5.25 in, 720Kb 3.5 in, **1.44/1.25MB**, 3.5 in and 2.88MB 3.5 in.

Parallel ATA

This setting allows the user to enable or disable the function of Parallel ATA. The options are Disabled, Channel 0, Channel 1 and **Both**.

Serial ATA

This setting allows the user to enable or disable the function of Serial ATA. The options are Disabled and **Enabled**.

Serial ATA RAID Enable

Select Enable to enable Serial ATA RAID Functions. (*For the Windows OS environment, use the RAID driver if this feature is set to Enabled. If set to **Disabled**, use the Non-RAID driver.)

Native Mode Operation

Select the native mode for ATA. The options are: Parallel ATA, Serial ATA, Both, and **Auto**.

►IDE Channel 0 Master/Slave, IDE Channel 1 Master/Slave, IDE Channel 2 Master, IDE Channel 3 Master

These settings allow the user to set the parameters of IDE Channel 0 Master/Slave, IDE Channel 1 Master/Slave, IDE Channel 2 Master, IDE Channel 3 Master slots. Hit <Enter> to activate the following sub-menu screen for detailed options of these items. Set the correct configurations accordingly. The items included in the sub-menu are:

PhoenixBIOS Setup - Copyright 1985-2001 Phoenix Technologies Ltd.	
Main	
Type:	Item Specific Help
CHS Format	User = you enter parameters of hard-disk drive installed at this connection. Auto = autotypes hard-disk drive installed here. 1-39 = you select pre-determined type of hard-disk drive installed here. CD-ROM = a CD-ROM drive is installed here. ATAPI Removable = removable disk drive is installed here.
Cylinders:	
Cylinders:	
Heads: [11]	
Heads:	
Sectors:	
Sectors:	
Maximum Capacity:	
Maximum Capacity:	
LBA Format	
Total Sectors:	
Maximum Capacity:	
Multi-Sector Transfers: [Disabled]	
LBA Mode Control: [Disabled]	
32 Bit I/O: [Disabled]	
Transfer Mode: [Standard]	
Ultra DMA Mode: [Disabled]	
F1 Help ↑↓ Select Item ~/+ Change Values F9 Setup Defaults Esc Exit ↔ Select Menu Enter Select ▶ Sub-Menu F10 Previous Values	

Type

Selects the type of IDE hard drive. The options are **Auto**, (which allows BIOS to automatically determine the hard drive's capacity, number of heads, etc.), a number from 1-39 to select a predetermined type of hard drive, CDROM and ATAPI Removable. The option- "User" will allow the user to enter the parameters of the HDD installed at this connection. The option-"Auto" will allow BIOS to automatically configure the parameters of the HDD installed at the connection. Choose the option 1-39 to select a predetermined HDD type. Select CDROM if a CDROM drive is installed. Select ATAPI if a removable disk drive is installed.

CHS Format

The following items will be displayed by the BIOS:

TYPE: This item displays the type of CPU.

Cylinders: This item indicates the status of Cylinders.

Headers: This item indicates the number of headers.

Sectors: This item displays the number of sectors.

Maximum Capacity: This item displays the maximum storage capacity of the system.

LBA Format

The following items will be displayed by the BIOS:

Total Sectors: This item displays the number of total sectors available in the LBA Format.

Maximum Capacity: This item displays the maximum capacity in the LBA Format.

Multi-Sector Transfer

This item allows the user to specify the number of sectors per block to be used in multi-sector transfer. The options are Disabled, 4 Sectors, 8 Sectors and **16 Sectors**.

LBA Mode Control

This item determines whether Phoenix BIOS will access the IDE Channel 0 Master Device via the LBA mode. The options are **Enabled** and Disabled.

32 Bit I/O

This option allows the user to enable or disable the function of 32-bit data transfer. The options are Enabled and **Disabled**.

Transfer Mode

Selects the transfer mode. The options are Standard, Fast PIO1, Fast PIO2, Fast PIO3, Fast PIO4, FPIO3/DMA1 and FPIO4/DMA2.

Ultra DMA Mode

Selects Ultra DMA Mode. The options are **Disabled**, Mode 0, Mode 1, Mode 2, Mode 3, Mode 4 and Mode 5.

System Memory

This display informs you how much system memory is recognized as being present in the system.

Extended Memory

This display informs you how much extended memory is recognized as being present in the system.

4-4 Advanced Setup

Choose Advanced from the Phoenix BIOS Setup Utility main menu with the arrow keys. You should see the following display. The items with a triangle beside them have sub menus that can be accessed by highlighting the item and pressing <Enter>. Options for PIR settings are displayed by highlighting the setting option using the arrow keys and pressing <Enter>. All Advanced BIOS Setup options are described in this section.

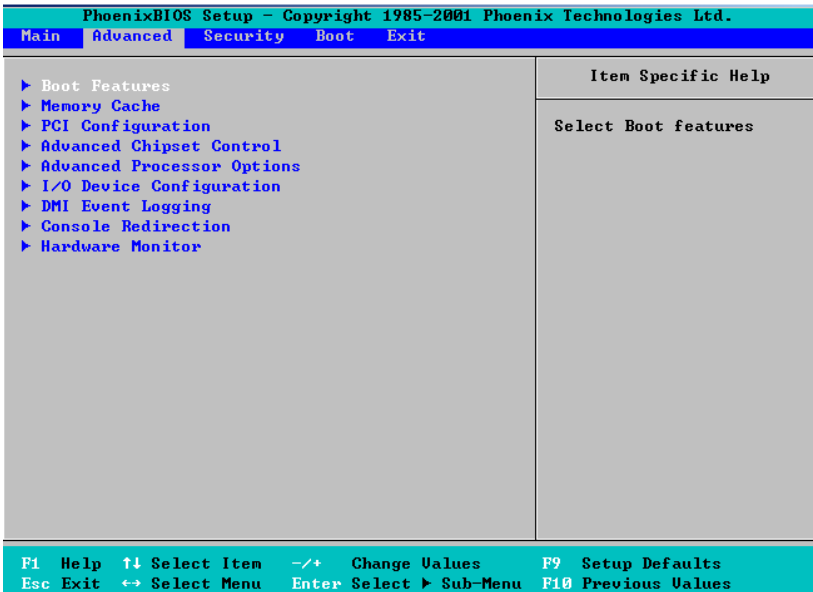

► Boot Features

Access the submenu to make changes to the following settings.

Quick Boot Mode

If enabled, this feature will speed up the POST (Power On Self Test) routine by skipping certain tests after the computer is turned on. The settings are **Enabled** and Disabled. If Disabled, the POST routine will run at normal speed.

Quiet Boot

This setting allows you to Enable or **Disable** the diagnostic screen during boot-up.

ACPI Mode

Use the setting to determine if you want to employ ACPI (Advanced Configuration and Power Interface) power management on your system. The options are **Yes** and No.

Power Button Behavior

If set to **Instant-Off**, the system will power off immediately as soon as the user hits the power button. If set to 4-sec., the system will power off when the user presses the power button for 4 seconds or longer. The options are instant-off and 4-sec override.

Resume On Modem Ring

Select On to “wake your system up” when an incoming call is received by your modem. The options are On and **Off**.

Power Loss Control

This setting allows you to choose how the system will react when power returns after an unexpected loss of power. The options are Stay Off, Power On and **Last State**.

Watch Dog

If enabled, this option will automatically reset the system if the system is not active for more than 5 minutes. The options are Enabled and **Disabled**.

Summary Screen

This setting allows you to **Enable** or Disable the summary screen which displays the system configuration during bootup.

►Memory Cache

Cache System BIOS Area

This setting allows you to designate a reserve area in the system memory to be used as a System BIOS buffer to allow the BIOS write (cache) its data into this reserved memory area. Select "**Write Protect**" to enable this function, and this area will be reserved for BIOS ROM access only. Select "Uncached" to disable this function and make this area available for other devices.

Cache Video BIOS Area

This setting allows you to designate a reserve area in the system memory to be used as a Video BIOS buffer to allow the BIOS write (cache) its data into this reserved memory area. Select "**Write Protect**" to enable the function and this area will be reserved for Video BIOS ROM access only. Select "Uncached" to disable this function and make this area available for other devices.

Cache Base 0-512K

If enabled, this feature will allow the data stored in the base memory area: block 0-512K to be cached (written) into a buffer, a storage area in the Static DRM (SDROM) or to be written into L1, L2 cache inside the CPU to speed up CPU operations. Select "Uncached" to disable this function. Select "Write Through" to allow data to be cached into the buffer and written into the system memory at the same time. Select "Write Protect" to prevent data from being written into the base memory area of Block 0-512K. Select "Write Back" to allow CPU to write data back directly from the buffer without writing data to the System Memory for fast CPU data processing and operation. The options are "Uncached", "Write Through", "Write Protect", and "**Write Back**".

Cache Base 512K-640K

If enabled, this feature will allow the data stored in the memory area: 512K-640K to be cached (written) into a buffer, a storage area in the Static DRM (SDROM) or written into L1, L2, L3 cache inside the CPU to speed up CPU operations. Select "Uncached" to disable this function. Select "Write Through" to allow data to be cached into the buffer and written into the system memory at the same time. Select "Write Protect"

to prevent data from being written into the base memory area of Block 0-512K. Select "Write Back" to allow CPU to write data back directly from the buffer without writing data to the System Memory for fast CPU data processing and operation. The options are "Uncached", "Write Through", "Write Protect", and "**Write Back**".

Cache Extended Memory

If enabled, this feature will allow the data stored in the extended memory area to be cached (written) into a buffer, a storage area in the Static DRAM (SDROM) or written into L1, L2, L3 cache inside the CPU to speed up CPU operations. Select "Uncached" to disable this function. Select "Write Through" to allow data to be cached into the buffer and written into the system memory at the same time. Select "Write Protect" to prevent data from being written into the base memory area of Block 0-512K. Select "Write Back" to allow CPU to write data back directly from the buffer without writing data to the System Memory for fast CPU data processing and operation. The options are "Uncached", "Write Through", "Write Protect", and "**Write Back**".

Discrete MTRR Allocation

If enabled, MTRRs (-Memory Type Range Registers) are configured as distinct, separate units and cannot be overlapped. If enabled, the user can achieve better graphic effects when using a Linux graphic driver that requires the write-combining configuration with 4GB or more memory. The options are Enabled and **Disabled**.

►PCI Configuration

Access the submenu to make changes to the following settings for PCI devices.

Onboard GLAN (Gigabit- LAN) OPROM Configure

Enabling this option provides the capability to boot from GLAN. The options are Disabled and **Enabled**.

Onboard SCSI OPROM Configure

Enabling this option provides the capability to boot from SCSI HDD. The options are Disabled and **Enabled**.

Default Primary Video Adapter

This item allows the user to select the Primary Video Adapter between two adapters instead of selecting among three or more adapters. The options are Other and **Onboard Video**.

PCI Parity Error Forwarding

Enable this item to forward the PCI errors occurring behind P2P bridges to South Bridge, so NMI can be asserted. The options are **Enabled** and **Disabled**.

ROM Scan Ordering

This feature allows the user to decide which Option ROM to be activated first. The options are **Onboard Option ROM first** and the **Add-On Option ROM first**.

Reset Configuration Data

If set to **Yes**, this setting clears the Extended System Configuration Data- (ESCD) area. The options are **Yes** and **No**.

Frequency for Slot#1-Slot#2/SCSI

This option allows the user to change the bus frequency for the devices installed in the slot indicated. The options are **Auto**, PCI 33 MHz, PCI 66 MHz, PCI-X 66 MHz, and PCI-X 100 MHz.

Frequency for Slot#3/G-LAN

This option allows the user to change the bus frequency of the devices installed in the slot indicated. The options are **Auto**, PCI 33 MHz, PCI 66 MHz, PCI-X 66 MHz, PCI-X 100 MHz, and PCI-X 133 MHz.

►PCI Devices, Slot #1 - Slot#6

Access the submenu for each of the settings above to make changes to the following:

Option ROM Scan

When enabled, this setting will initialize the device expansion ROM. The options are **Enabled** and **Disabled**.

Enable Master

This setting allows you to enable the selected device as the PCI bus master. The options are **Enabled** and **Disabled**.

Latency Timer

This setting allows you to set the clock rate for Bus Master. A high-priority, high-throughput device may benefit from a greater Clock rate. The options are **Default**, 0020h, 0040h, 0060h, 0080h, 00A0h, 00C0h, and 00E0h. For Unix, Novell and other Operating Systems, please select the option: other.

If a drive fails after the installation of a new software, you might want to change this setting and try again. Different OS requires different Bus Master clock rate.

Large Disk Access Mode

This setting determines how large hard drives are to be accessed. The options are **DOS** or **Other** (for Unix, Novelle NetWare and other operating systems).

► Advanced Chipset Control

Access the submenu to make changes to the following settings.

Force Compliance Mode

This feature allows you to enable the PCI-Express Compliance Mode. The options are: **Disabled** or **Enabled**.

Memory RAS Feature Control

Select this option in order to enable the special feature of DIMM sparing or memory mirroring. The options are **Mirroring**, **Sparing** and **Standard**.

Clock Spectrum Feature

If "Enabled", BIOS will monitor the level of Electromagnetic Interference caused by the components and will attempt to decrease the interference whenever needed. The options are **Enabled** and **Disabled**.

Memory Remap Function Control

PCI memory resources will overlap with the physical memory if 4GB of memory or above is installed on the motherboard. When this occurs, **enable** this function to reallocate the overlapped physical memory to a location above 4GB to resolve the memory overlapping situation.

DRAM Data Integrity Mode

If enabled, this feature allows the data stored in the DRAMA memory to be integrated for faster data processing. The options are **72-bit ECC**, **144-bit ECC**, **Auto** and **Disabled**.

ECC Error Type

This setting lets you select which type of interrupt to be activated as a result of an ECC error. The options are **None**, **NMI** (Non-Maskable Interrupt), **SMI** (System Management Interrupt) and **SCI** (System Control Interrupt.)

SERR Signal Condition

This setting specifies the ECC Error conditions that an SERR# is to be asserted. The options are None, **Single Bit**, Multiple Bit and Both.

Enabling Multi-Media Timer

Select Yes to activate a set of timers that are alternative to the traditional 8254 timers for the OS use. The options are Yes and **No**.

USB Function

Select Enabled to enable the function of USB devices specified. The settings are **Enabled** and Disabled.

Legacy USB Support

This setting allows you to enable support for Legacy USB devices. The settings are **Enabled** and Disabled.

►Advanced Processor Options

Access the submenu to make changes to the following settings.

CPU Speed

This is a display that indicates the speed of the installed processor.

Hyper-threading (*Available when supported by the CPU.)

Set to Enabled to use the Hyper-Threading Technology, which will result in increased CPU performance. The options are Disabled or **Enabled**.

Machine Checking (*Available when supported by the CPU.)

Set to Enabled to activate the function of Machine Checking and allow the CPU to detect and report hardware (machine) errors via a set of model-specific registers (MSRs). The options are Disabled or **Enabled**.

C1 Enhanced Mode (*Available when supported by the CPU.)

Set to Enabled to enable Enhanced Halt State to lower CPU voltage/frequency to prevent overheat. The options are Enabled and **Disabled**.
(*Note: please refer to Intel's web site for detailed information.)

No Execute Mode Memory Protection (*Available when supported by the CPU and the OS.)

Set to **Enabled** to enable Execute Disable Bit and allow the processor to classify areas in memory where an application code can execute and where it can not, and thus, preventing a worm or a virus from inserting and creating a flood of codes to overwhelm the processor or damage the system during an attack.

(*Note: this feature is available when your OS and your CPU support the function of Execute Disable Bit.) The options are Disabled and **Enabled**.
(Note: For more information regarding hardware/software support for this function, please refer to Intel's and Microsoft's web sites.)

Thermal Management 2 (*Available when supported by the CPU.)

Set to Enabled to use Thermal Management 2 (TM2) which will lower CPU voltage and frequency when the CPU temperature reaches a pre-defined overheat threshold. Set to **Disabled** to use Thermal Manager 1 (TM1), allowing CPU clocking to be regulated via CPU Internal Clock modulation when the CPU temperature reaches the overheat threshold.

Adjacent Cache Line Prefetch (*Available when supported by the CPU.)

The CPU fetches the cache line for 64 bytes if this option is set to Disabled. The CPU fetches both cache lines for 128 bytes as comprised if Enabled. The options are Disabled and **Enabled**.

Processor Power Management

This feature allows the user to determine the processor power management mode. The options are **Disabled** and C States Only. If set to Disabled, C States and GV1/GV3 are disabled. If set to C States only, the processor power will be controlled through CPU power states in the ACPI setting.

► I/O Device Configuration

Access the submenu to make changes to the following settings.

Serial Port A

This setting allows you to assign control of serial port A. The options are **Enabled** (user defined), Disabled, and Auto (BIOS- or OS- controlled).

Base I/O Address

Select the base I/O address for serial port A. The options are **3F8**, 2F8, 3E8 and 2E8.

Interrupt

Select the IRQ (interrupt request) for serial port A. The options are IRQ3 and **IRQ4**.

Serial Port B

This setting allows you to assign control of serial port B. The options are **Enabled** (user defined), Disabled, Auto (BIOS controlled) and OS Controlled.

Mode

Specify the type of device that will be connected to serial port B. The options are **Normal**, and IR (for an infrared device).

Base I/O Address

Select the base I/O address for serial port B. The options are 3F8, **2F8**, 3E8 and 2E8.

Interrupt

Select the IRQ (interrupt request) for serial port B. The options are **IRQ3** and IRQ4.

Parallel Port

This setting allows you to assign control of the parallel port. The options are **Enabled** (user defined), Disabled and Auto (BIOS-or OS- controlled).

Base I/O Address

Select the base I/O address for the parallel port. The options are **378**, 278 and 3BC.

Interrupt

Select the IRQ (interrupt request) for the parallel port. The options are IRQ5 and **IRQ7**.

DMA Channel

This item allows you to specify the DMA channel for the parallel port. The options are DMA1 and **DMA3**.

Floppy Disk Controller

This setting allows you to assign control of the floppy disk controller. The options are **Enabled** (user defined), Disabled, and Auto (BIOS and OS controlled).

Base I/O Address

Select the base I/O address for the parallel port. The options are **Primary** and Secondary.

► DMI Event Logging

Access the submenu to make changes to the following settings.

Event Log Validity

This is a display to inform you of the event log validity. It is not a setting.

Event Log Capacity

This is a display to inform you of the event log capacity. It is not a setting.

View DMI Event Log

Highlight this item and press <Enter> to view the contents of the event log.

Event Logging

This setting allows you to **Enable** or Disable event logging.

ECC Event Logging

This setting allows you to **Enable** or Disable ECC event logging.

Mark DMI Events as Read

Highlight this item and press <Enter> to mark the DMI events as read.

Clear All DMI Event Logs

Select Yes and press <Enter> to clear all DMI event logs. The options are Yes and **No**.

► Console Redirection

Access the submenu to make changes to the following settings.

COM Port Address

This item allows you to specify to redirect the console to Onboard COM A or Onboard COM B. This setting can also be **Disabled**.

BAUD Rate

This item allows you to select the BAUD rate for console redirection. The options are 300, 1200, 2400, 9600, **19.2K**, 38.4K, 57.6K and 115.2K.

Console Type

This item allows you to choose from the available options to select the console type for console redirection. The options are VT100, VT100,8bit, PC-ANSI, 7bit, **PC ANSI**, VT100+, VT-UTF8.

Flow Control

This item allows you to choose from the available options to select the flow control for console redirection. The options are: None, XON/XOFF, and **CTS/RTS**.

Console Connection

This item allows you to choose select the console connection: either **Direct** or Via Modem.

Continue CR after POST

Choose whether to continue with console redirection after the POST routine. The options are On and **Off**.

► Hardware Monitor Logic

CPU Temperature Threshold

This option allows the user to set a CPU temperature threshold that will activate the alarm system when the CPU temperature reaches this pre-set temperature threshold. The options are 70°C, **75°C**, 80°C and 85°C.

Highlight this and hit <Enter> to see monitor data for the following items:

CPU1 Temperature: This item displays CPU1 Temperature.

CPU2 Temperature: This item displays CPU2 Temperature.

System Temperature: This item displays the System Temperature.

Fan Speed Control Modes

This feature allows the user to decide how the system controls the speeds of the onboard fans. The CPU temperature and the fan speed are correlative. When the CPU on-die temperature increases, the fan speed will also increase, and vice versa. If the option is set to “3-pin fan”, the fan speed is controlled by voltage. If the option is set to “4-pin”, the fan speed will be controlled by Pulse Width Modulation (PWM). Select “3-pin” if your chassis came with 3-pin fan headers. Select “4-pin” if your chassis came with 4-pin fan headers. Select “Workstation” if your system is used as a Workstation. Select “Server” if your system is used as a Server. Select “Disable” to disable the fan speed control function to allow the onboard fans to run at the full speed (12V) at all the time. The Options are: **1. Disable**, 2. 3-pin (Server), 3. 3-pin (Workstation), 4. 4-pin (Server) and 5. 4-pin (Workstation).

Fan 1-FAN8: If the feature of Auto Fan Control is enabled, BIOS will automatically display the status of the fans indicated in this item.

Vcore A/Vcore B: These items display the Voltage status of CPU A and CPU B.

P3V3: This item displays the +3.3V voltage status.

P5V: This item displays the +5V voltage status.

N12V: This item displays the -12V voltage status.

P12V: This item displays the +12V voltage status.

VDD: This item displays the VDD status.

P5Vsb: This item displays the voltage status of +5V Standby power.

P3P3Vsb: This item displays the voltage status of +3.3V Standby power.

4-5 Security

Choose Security from the Phoenix BIOS Setup Utility main menu with the arrow keys. You should see the following display. Security setting options are displayed by highlighting the setting using the arrow keys and pressing <Enter>. All Security BIOS settings are described in this section.

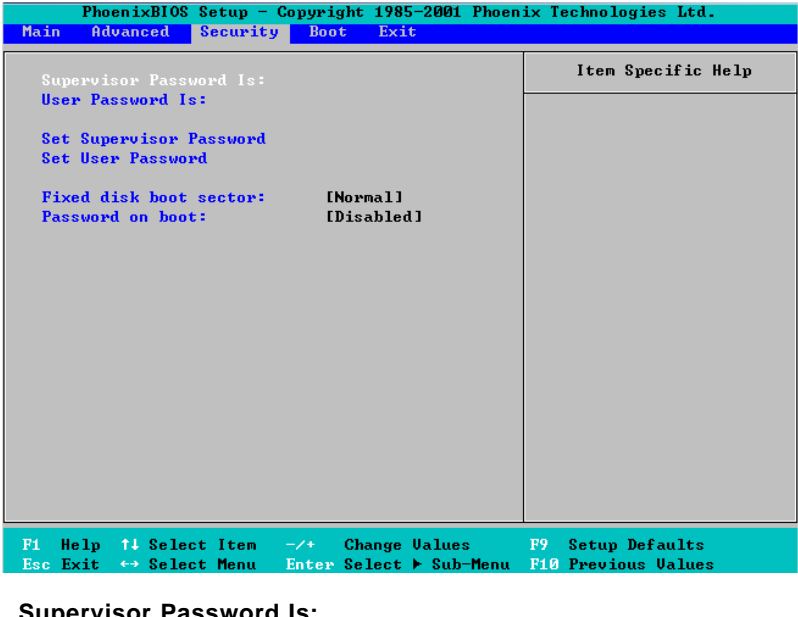

Supervisor Password Is:

This displays whether a supervisor password has been entered for the system. Clear means such a password has not been used and Set means a supervisor password has been entered for the system.

User Password Is:

This displays whether a user password has been entered for the system. Clear means such a password has not been used and Set means a user password has been entered for the system.

Set Supervisor Password

When the item "Set Supervisor Password" is highlighted, hit the <Enter> key. When prompted, type the Supervisor's password in the dialogue box to set or to change supervisor's password, which allows access to BIOS.

Set User Password

When the item "Set User Password" is highlighted, hit the <Enter> key. When prompted, type the user's password in the dialogue box to set or to

change the user's password, which allows access to the system at boot-up.

Fixed Disk Boot Sector

This setting may offer some protection against viruses when set to Write Protect, which protects the boot sector on the hard drive from having a virus written to it. The other option is **Normal**.

Password on Boot

This setting allows you to require a password to be entered when the system boots up. The options are Enabled (password required) and Disabled (password not required).

4-6 Boot

Choose Boot from the Phoenix BIOS Setup Utility main menu with the arrow keys. You should see the following display. Highlighting a setting with a + or - will expand or collapse that entry. See details on how to change the order and specs of boot devices in the Item Specific Help window. All Boot BIOS settings are described in this section.

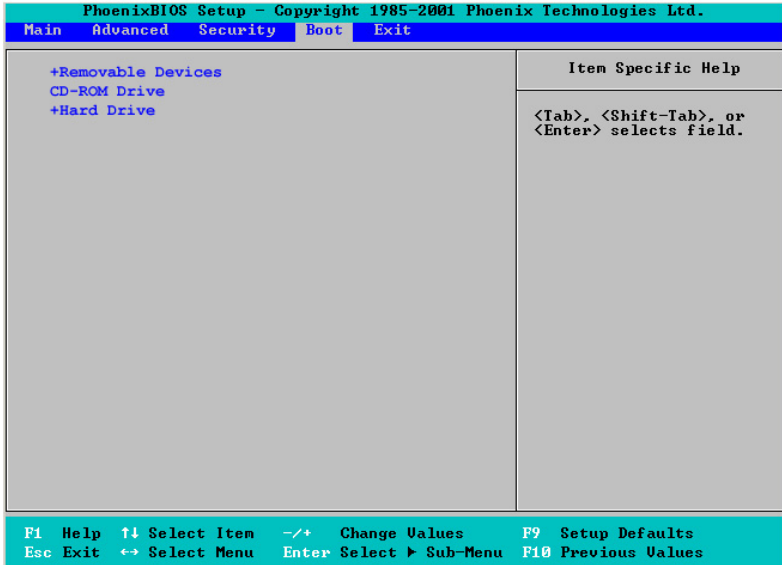

+Removable Devices

Highlight and press <Enter> to expand the field. See details on how to change the order and specs of devices in the Item Specific Help window.

CDROM Drive

See details on how to change the order and specs of the CDROM drive in the Item Specific Help window.

+Hard Drive

Highlight and press <Enter> to expand the field. See details on how to change the order and specs of hard drives in the Item Specific Help window.

4-7 Exit

Choose Exit from the Phoenix BIOS Setup Utility main menu with the arrow keys. You should see the following display. All Exit BIOS settings are described in this section.

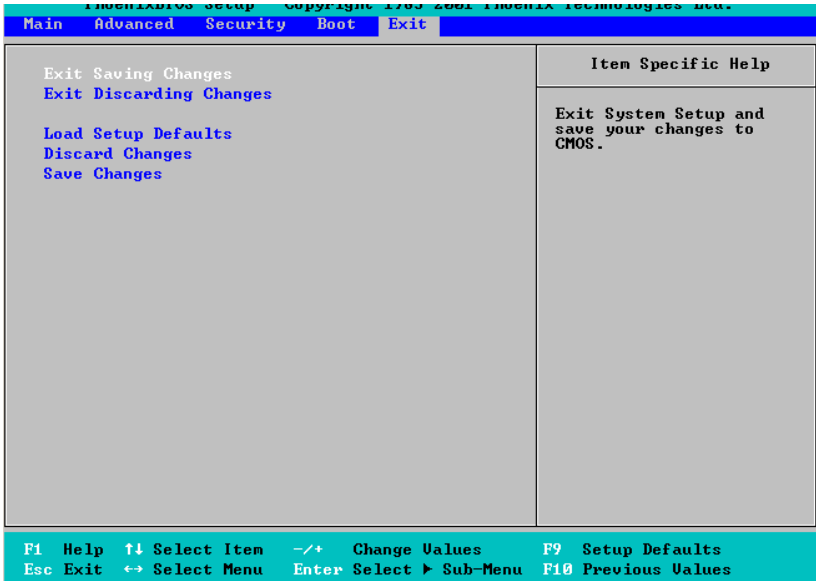

Exit Saving Changes

Highlight this item and hit <Enter> to save any changes you made and to exit the BIOS Setup utility.

Exit Discarding Changes

Highlight this item and hit <Enter> to exit the BIOS Setup utility without saving any changes you may have made.

Load Setup Defaults

Highlight this item and hit <Enter> to load the default settings for all items in the BIOS Setup. These are the safest settings to use.

Discard Changes

Highlight this item and hit <Enter> to discard (cancel) any changes you made. You will remain in the Setup utility.

Save Changes

Highlight this item and hit <Enter> to save any changes you made. You will remain in the Setup utility.

Appendix A BIOS POST Codes

This section lists the POST (Power On Self Test) codes for the PhoenixBIOS. POST codes are divided into two categories: recoverable and terminal.

Recoverable POST Errors

When a recoverable type of error occurs during POST, the BIOS will display an POST code that describes the problem. BIOS may also issue one of the following beep codes:

- 1 long and two short beeps - video configuration error
- 1 continuous long beep - no memory detected

Terminal POST Errors

If a terminal type of error occurs, BIOS will shut down the system. Before doing so, BIOS will write the error to port 80h, attempt to initialize video and write the error in the top left corner of the screen.

The following is a list of codes that may be written to port 80h.

POSTCode	Description
02h	Verify Real Mode
03h	Disable Non-Maskable Interrupt (NMI)
04h	Get CPU type
06h	Initialize system hardware
07h	Disable shadow and execute code from the ROM.
08h	Initialize chipset with initial POST values
09h	Set IN POST flag
0Ah	Initialize CPU registers
0Bh	Enable CPU cache
0Ch	Initialize caches to initial POST values
0Eh	Initialize I/O component
0Fh	Initialize the local bus IDE
10h	Initialize Power Management
11h	Load alternate registers with initial POST values
12h	Restore CPU control word during warm boot
13h	Initialize PCI Bus Mastering devices
14h	Initialize keyboard controller
16h	1-2-2-3 BIOS ROM checksum
17h	Initialize cache before memory Auto size

POST Code	Description
18h	8254 timer initialization
1Ah	8237 DMA controller initialization
1Ch	Reset Programmable Interrupt Controller
20h	1-3-1-1 Test DRAM refresh
22h	1-3-1-3 Test 8742 Keyboard Controller
24h	Set ES segment register to 4 GB
28h	Auto size DRAM
29h	Initialize POST Memory Manager
2Ah	Clear 512 kB base RAM
2Ch	1-3-4-1 RAM failure on address line xxxx*
2Eh	1-3-4-3 RAM failure on data bits xxxx* of low byte of memory bus
2Fh	Enable cache before system BIOS shadow
32h	Test CPU bus-clock frequency
33h	Initialize Phoenix Dispatch Manager
36h	Warm start shut down
38h	Shadow system BIOS ROM
3Ah	Auto size cache
3Ch	Advanced configuration of chipset registers
3Dh	Load alternate registers with CMOS values
41h	Initialize extended memory for RomPilot
42h	Initialize interrupt vectors
45h	POST device initialization
46h	2-1-2-3 Check ROM copyright notice
47h	Initialize I20 support
48h	Check video configuration against CMOS
49h	Initialize PCI bus and devices
4Ah	Initialize all video adapters in system
4Bh	QuietBoot start (optional)
4Ch	Shadow video BIOS ROM
4Eh	Display BIOS copyright notice
4Fh	Initialize MultiBoot
50h	Display CPU type and speed
51h	Initialize EISA board
52h	Test keyboard
54h	Set key click if enabled
55h	Enable USB devices
58h	2-2-3-1 Test for unexpected interrupts
59h	Initialize POST display service
5Ah	Display prompt "Press F2 to enter SETUP"
5Bh	Disable CPU cache

POSTCode	Description
5Ch	Test RAM between 512 and 640 kB
60h	Test extended memory
62h	Test extended memory address lines
64h	Jump to UserPatch1
66h	Configure advanced cache registers
67h	Initialize Multi Processor APIC
68h	Enable external and CPU caches
69h	Setup System Management Mode (SMM) area
6Ah	Display external L2 cache size
6Bh	Load custom defaults (optional)
6Ch	Display shadow-area message
6Eh	Display possible high address for UMB recovery
70h	Display error messages
72h	Check for configuration errors
76h	Check for keyboard errors
7Ch	Set up hardware interrupt vectors
7Dh	Initialize Intelligent System Monitoring
7Eh	Initialize coprocessor if present
80h	Disable onboard Super I/O ports and IRQs
81h	Late POST device initialization
82h	Detect and install external RS232 ports
83h	Configure non-MCD IDE controllers
84h	Detect and install external parallel ports
85h	Initialize PC-compatible PnP ISA devices
86h	Re-initialize onboard I/O ports.
87h	Configure Motherboard Configurable Devices (optional)
88h	Initialize BIOS Data Area
89h	Enable Non-Maskable Interrupts (NMIs)
8Ah	Initialize Extended BIOS Data Area
8Bh	Test and initialize PS/2 mouse
8Ch	Initialize floppy controller
8Fh	Determine number of ATA drives (optional)
90h	Initialize hard-disk controllers
91h	Initialize local-bus hard-disk controllers
92h	Jump to UserPatch2
93h	Build MPTABLE for multi-processor boards
95h	Install CD ROM for boot
96h	Clear huge ES segment register
97h	Fix up Multi Processor table
98h	1-2 Search for option ROMs. One long, two short beeps on checksum failure

POST Code	Description
99h	Check for SMART Drive (optional)
9Ah	Shadow option ROMs
9Ch	Set up Power Management
9Dh	Initialize security engine (optional)
9Eh	Enable hardware interrupts
9Fh	Determine number of ATA and SCSI drives
A0h	Set time of day
A2h	Check key lock
A4h	Initialize typematic rate
A8h	Erase F2 prompt
AAh	Scan for F2 key stroke
ACh	Enter SETUP
AEh	Clear Boot flag
B0h	Check for errors
B1h	Inform RomPilot about the end of POST.
B2h	POST done - prepare to boot operating system
B4h	1 One short beep before boot
B5h	Terminate QuietBoot (optional)
B6h	Check password (optional)
B7h	Initialize ACPI BIOS
B9h	Prepare Boot
BAh	Initialize SMBIOS
BBh	Initialize PnP Option ROMs
BCh	Clear parity checkers
BDh	Display MultiBoot menu
BEh	Clear screen (optional)
BFh	Check virus and backup reminders
C0h	Try to boot with INT 19
C1h	Initialize POST Error Manager (PEM)
C2h	Initialize error logging
C3h	Initialize error display function
C4h	Initialize system error handler
C5h	PnPnd dual CMOS (optional)
C6h	Initialize note dock (optional)
C7h	Initialize note dock late
C8h	Force check (optional)
C9h	Extended checksum (optional)
CAh	Redirect Int 15h to enable remote keyboard
CBh	Redirect Int 13h to Memory Technologies Devices such as ROM, RAM, PCMCIA, and serial disk
CCh	Redirect Int 10h to enable remote serial video

POST Code	Description
CDh	Re-map I/O and memory for PCMCIA
CEh	Initialize digitizer and display message
D2h	Unknown interrupt

The following are for boot block in Flash ROM

POST Code	Description
E0h	Initialize the chipset
E1h	Initialize the bridge
E2h	Initialize the CPU
E3h	Initialize system timer
E4h	Initialize system I/O
E5h	Check force recovery boot
E6h	Checksum BIOS ROM
E7h	Go to BIOS
E8h	Set Huge Segment
E9h	Initialize Multi Processor
EAh	Initialize OEM special code
EBh	Initialize PIC and DMA
ECh	Initialize Memory type
EDh	Initialize Memory size
EEh	Shadow Boot Block
EFh	System memory test
F0h	Initialize interrupt vectors
F1h	Initialize Run Time Clock
F2h	Initialize video
F3h	Initialize System Management Manager
F4h	Output one beep
F5h	Clear Huge Segment
F6h	Boot to Mini DOS
F7h	Boot to Full DOS

* If the BIOS detects error 2C, 2E, or 30 (base 512K RAM error), it displays an additional word-bitmap (**xxxx**) indicating the address line or bits that failed. For example, "2C 0002" means address line 1 (bit one set) has failed. "2E 1020" means data bits 12 and 5 (bits 12 and 5 set) have failed in the lower 16 bits. The BIOS also sends the bitmap to the port-80 LED display. It first displays the checkpoint code, followed by a delay, the high-order byte, another delay, and then the low-order byte of the error. It repeats this sequence continuously.

Notes

Appendix B

Installing Software Drivers and Windows Operating System

After all the hardware has been installed, you must first configure the Adaptec Embedded Serial ATA RAID Driver before you install the Windows operating system. The necessary drivers are all included on the Supermicro bootable CDs that came packaged with your motherboard. (*The following section provides information on Adaptec's SATA RAID Driver based on the Intel ICH5R Controller. For detailed information on Adaptec's SCSI SATA HostRAID Utility, please refer to the CDs included in the shipping package*)

B-1 Introduction to the Adaptec Embedded Serial ATA RAID Controller Driver

Serial ATA (SATA)

Serial ATA(SATA) is a physical storage interface. It uses a single cable with a minimum of four wires to create a point-to-point connection between devices. It is a serial link which supports SATA Transfer rates from 150MBps. Because the serial cables used in SATA are thinner than the traditional cables used in Parallel ATA(PATA), SATA systems have better airflow and can be installed in smaller chassis than Parallel ATA. In addition, the cables used in PATA can only extend to 40cm long, while Serial ATA cables can extend up to one meter. Overall, Serial ATA provides better functionality than Parallel ATA.

Introduction to the Intel ICH5R I/O Controller Hub

Located in the South Bridge of the Intel E7520 (Lindenhurst)Chipset, the ICH5R I/O Controller Hub provides the I/O subsystem with access to the rest of the system. It supports 2-channel Ultra ATA/100 Bus Master IDE controller (PATA) and two Serial ATA (SATA) Host Controllers, which support up to two Serial ATA ports and up to two RAID drives. The ICH5R I/O Controller Hub supports the following Parallel ATA (PATA) and Serial (SATA) device configurations:

ATA Operate Mode

You can select from the following two modes: Combined Mode and Enhanced Mode.

Combined Mode:

In this mode, system BIOS assigns the traditional IRQ 14 and IRQ 15 for the use of HDD. Up to 4 ATA devices are supported by this mode.

Within the Combined Mode, the following three modes are supported:

*Non-Combined Mode: Parallel ATA only:with the maximum of 4 devices supported;

*Non-Combined Mode: Serial ATA only:with the maximum of 2 devices supported;

*Combined Mode: SATA devices and PATA: with the support of 2 devices each (total: 4 devices maximum). (For IDE/SATA configurations, please refer to the table below.)

Primary Master(=PM)	Yes	Yes	No	No	No	No
Primary Slave(=PS)	Yes	No	Yes	No	No	No
Secondary Master(=SM)	Yes	No	No	Yes	No	No
Secondary Slave(=SS)	Yes	No	No	No	Yes	No
SATA Port0	No	SM	SM	PM	PM	PM
SATA Port1	No	SS	SS	PS	PS	PS

*Note: (No=Not Present, Yes=Present) Also, if Logical Primary is selected, the IDE channels are no longer available.

Enhanced Mode:

In this mode, system BIOS will automatically search for all available IRQs for the use of HDD. For newer Operating Systems that support the Enhanced Mode, such as Windows XP, Windows 2000, and Windows 2003, you can set SATA and PATA to the Enhanced Mode. (*The newer Operating Systems can accommodate both Enhanced Mode and Combined Mode and support up to 6 ATA devices.)

(*Please refer to the "Advanced Chipset Control" under the "Advanced" Setup in the BIOS for the selection of Combined Mode or Enhanced Mode.)

Configuring BIOS settings for the SATA RAID Functions (Enhanced Mode)

1. Press the key during system bootup to enter the BIOS Setup Utility.

(*Note: If it is the first time to power on the system, we recommend that you load the Optimized Default Settings. If you have already done so, please skip to Step 3.

2. Use the arrow keys to select the "Exit" Menu. Once in the "Exit" Menu, scroll down the menu to select the item- "Load Setup Default" and press the <Enter> key. Select "Yes" to confirm the selection. Press the <Enter> key to load the default settings to the BIOS.

3. Use the arrow keys to select the "Main" Menu in the BIOS.

4. Scroll down to "SATA RAID Enable" and press the <Enter> Key to select this option.

5. From this submenu, select "Enable" and press <Enter>.

6. Tap the <Esc> key and scroll down to "Exit". Select "Save and Exit" from the "Exit" menu. Press the <Enter> key to save the changes and exit the BIOS.

7. Once you've exited the BIOS Utility, the system will re-boot.

8. During the system startup, press the <Ctrl> and the <A> keys simultaneously to run the Adaptec RAID Configuration Utility when prompted by the following message:

Press <Ctrl><A> for Adaptec RAID Configuration Utility

The Adaptec Embedded Serial ATA with HostRAID Controller Driver

Adaptec's Embedded Serial ATA RAID with HostRAID controller adds RAID functionality to the Serial ATA I/O controller by supporting RAID 0 (Striping) or RAID 1 (Mirroring) to enhance the industry's pioneer PCI-to-e host controller products. RAID striping (RAID 0) can greatly improve hard disk I/O performance because of its capability in striping data across multiple drives. RAID mirroring (RAID 1) allows the data to be simultaneously written to two drives, so critical data is always available even if a single hard disk fails. Due to the built-in functionality, the X6DH8-G2/X6DHE-G2 is specially designed to keep pace with the increasing performance demands of computer systems by improving disk I/O throughput and providing data accessibility regardless of a single disk failure. By incorporating the Adaptec Embedded Serial ATA into the motherboard design, Supermicro's X6DH8-G2/X6DHE-G2 offers the user with the benefits of SATARAID without the high costs associated with hardware RAID applications.

(***Note:** For Adaptec's RAID Driver Installation Instructions, please refer to the Adaptec RAID Controller User's Guide: "Emb_SA_RAID_UG.pdf" in the CD that came with this motherboard. You can also download a copy of Adaptec's User's Guide from our web site at www.supermicro.com.)

Using the Adaptec RAID Configuration Utility (ARC)

The Adaptec RAID Configuration Utility is an embedded BIOS Utility, including:

*Array Configuration Utility: Use this utility when you want to create, configure and manage arrays.

* Disk Utilities: Use this option to format or verify disks.

To run the Adaptec RAID Configuration Utility, you will need to enable the RAID function in the system BIOS (refer to Chapter 4 for System BIOS Configurations), and then, press the <Ctrl> and <A> keys simultaneously when prompted to do so during the system startup. (Refer to the previous page for detailed instructions.)

(***Note:** To select an option, use the arrow keys to highlight the item and then press the <Enter> key to select it. To return to the previous menu, press the <ESC> key.)

A. Using the Array Configuration Utility (ACU)

The Array Configuration Utility (ACU) enables you to create, manage, and delete arrays from the controller's BIOS, add and delete spare drives, and initialize drives. During the system startup, press <Ctrl> and <A> key simultaneously, and the main menu will appear.

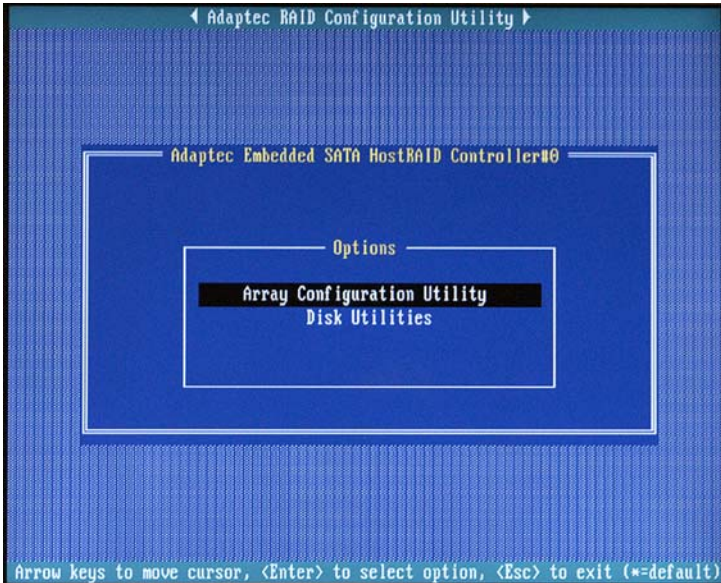

Managing Arrays

Select this option to view array properties, and delete arrays. The following sections describe the operations Of "Managing Arrays".

To select this option, use the arrow keys and the <enter> key to select "Managing Arrays" from the main menu (as shown above).

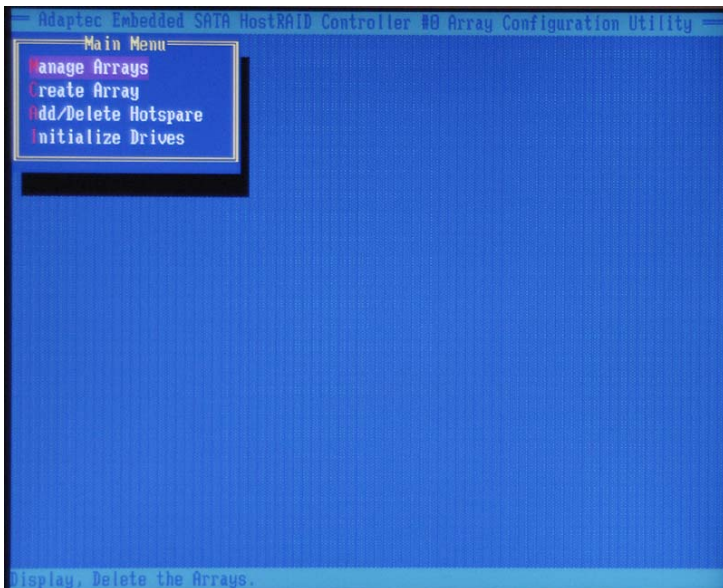

Viewing Array Properties

To view the properties of an existing array:

1. At the BIOS prompt, press **Ctrl+A**.
2. From the ARC menu, select **Array Configuration Utility (ACU)**.
3. From the ACU menu, select **Manage Arrays** (as shown on the previous screen.)
4. From the List of Arrays dialog box, select the array you want to view and press **Enter**.

The Array Properties dialog box appears, showing detailed information on the array. The physical disks associated with the array are displayed here.

5. Press **Esc** to return to the previous menu.

Deleting Arrays

**Warning: Back up the data on an array before you delete it to prevent the loss of data. Deleted arrays cannot be restored.*

To delete an existing array:

1. Turn on your computer and press **Ctrl+A** when prompted to access the ARC utility.
2. From the ARC main menu, select **Array Configuration Utility (ACU)**.
3. From the ACU menu, select **Manage Arrays**.
4. Select the array you wish to delete and press **Delete**.
5. In the Array Properties dialog box, select **Delete** and press **Enter**. The following prompt is displayed:

**Warning!! Deleting the array will render array unusable. Do you want to delete the array?(Yes/No):*

RAID 1 only—the following prompt is also displayed:

Deleting the partition will result in data loss! Do you also want to delete the partition? (Yes/No):

6. Press **Yes** to delete the array or partition or **No** to return to the previous menu.
7. Press **Esc** to return to the previous menu.

Creating Arrays

Before creating arrays, make sure the disks for the array are connected and installed in your system. Note that disks with no usable space, or disks that are un-initialized are shown in gray and cannot be used. See *Initializing Disk Drives*.

To create an array:

- 1 Turn on your computer and press **Ctrl+A** when prompted to access the ARC utility.
 - 2 From the ARC menu, select **Array Configuration Utility Main Menu (ACU)** (as shown on the first screen on page B-5).
 - 3 From the ACU menu, select **Create Array**.
 - 4 Select the disks for the new array and press **Insert** (as the screen shown below).
- (***Note:** To deselect any disk, highlight the disk and press **Delete**.)

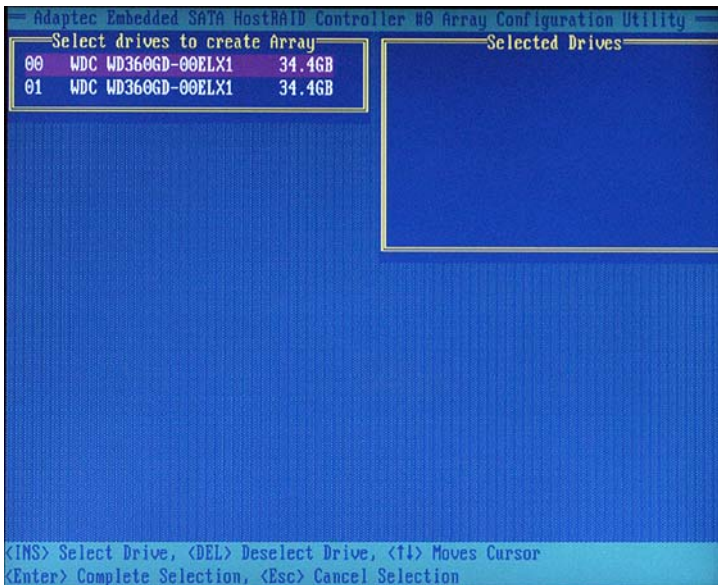

- 5 Press **Enter** when both disks for the new array are selected. The Array Properties menu displays (as the screen shown on the next page).

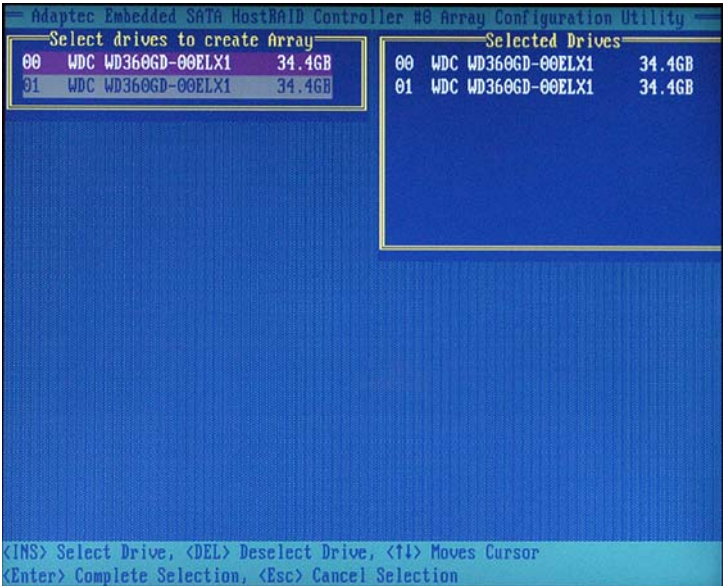

Assigning Array Properties

Once you've create a new array, you are ready to assign the properties to the array.

***Caution:** Once the array is created and its properties are assigned, you cannot change the array properties using the ACU. You will need to use the Adaptec Storage Manager - Browser Edition. (Refer to Adaptec's User's Guide in the enclosed CD.)

To assign properties to the new array:

1. In the Array Properties menu (as shown in the following screen), select an array type and press **Enter**.

Note that only the available array types: RAID 0, and RAID1, are displayed on the screen. (*RAID 0 or RAID 1 requires two drives.)

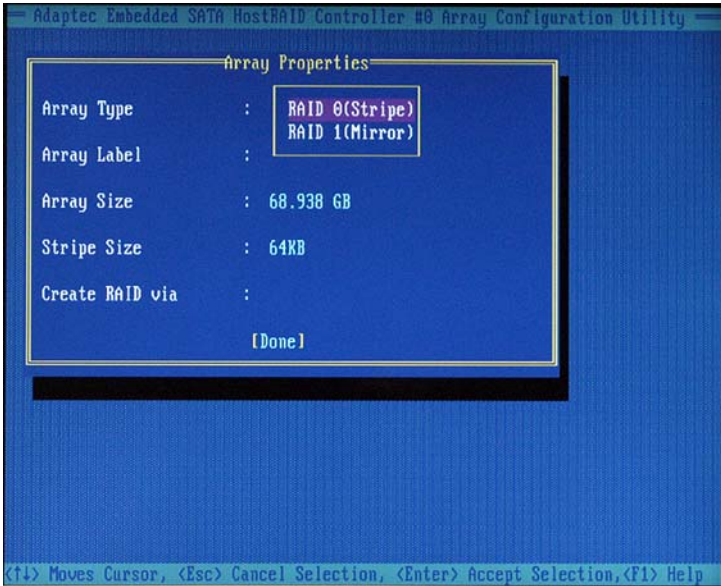

2. Under the item "**Arrays Label**", type in an label and press **Enter**. (***Note:** The label shall not be more than 15 characters.)
3. For RAID 0, select the desired stripe size. (***Note:** Available stripe sizes are 16, 32, and 64 KB-default. It is recommended that you *do not* change the default setting.)
4. The item: "**Create RAID via**" allows you to select between the different creating methods for RAID 0 and RAID 1.
The following table gives examples of when each is appropriate.

Raid Level	Create Via	When Appropriate
RAID 0	No Init	Creating a RAID 0 on new drives
RAID 0	Migrate (* Note)	Creating a RAID 0 from one new drive and one drive with data you wish to preserve
RAID 1	Build1	Any time you wish to create a RAID 1, but especially if you have data on one drive that you wish to preserve
RAID 1	Clear	Creating a RAID 1 on new drives, or when you want to ensure that the array contains no data after creation.
RAID 1	Quick	Fastest way to create a RAID 1. Appropriate when using new drives
RAID 1	Init	

(***Note:** If you select Migrate for RAID 0, or Build for RAID 1, you will be asked to select the source drive. The contents of the source drive will be preserved. However, the data on the new drive will be lost.)

5. When you are finished, press **Done** (as the screen shown below).

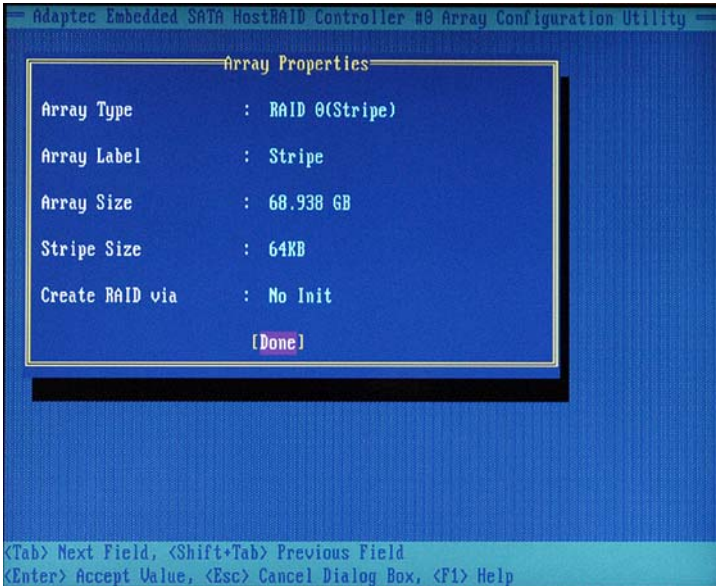

Notes:

1. Before adding a new drive to an array, back up any data contained on the new drive. Otherwise, all data will be lost.
2. If you stop the Build or Clear process on a RAID 1 from ACU, you can restart it by pressing Ctrl+R.
3. A RAID 1 created using the Quick Init option may return some data mismatches if you later run a consistency check. This is normal and is not a cause for concern.
4. The ACU allows you to use drives of different sizes in a RAID . However, during a build operation, only the smaller drive can be selected as the source or first drive.
5. When migrating from single volume to RAID 0, migrating from a larger drive to a smaller drive is allowed. However, the destination drive must be at least half the capacity of the source drive.
6. Adaptec does not recommend that you migrate or build an array on Windows dynamic disks (volumes), as it will result in data loss.

Warning: Do not interrupt the creation of a RAID 0 using the Migrate option. If you do, you will not be able to restart, or to recover the data that was on the source drive.

Adding a Bootable Array

To make an array bootable:

1. From the Main menu, select **Manage Arrays**.
2. From the List of Arrays, select the array you want to make bootable, and press **Ctrl+B**.
3. Enter Y to create a bootable array when the following message is displayed: "This will make all other existing bootable array non-bootable. Do you want to make this array bootable? (Yes/No):" Then, a bootable array will be created. An asterisk will appear next to the bootable array (as shown in the picture below:)

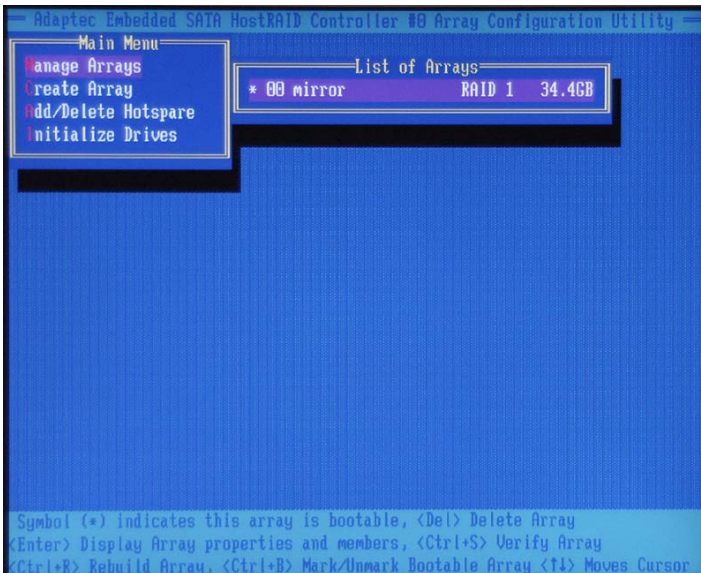

Deleting a Bootable Array

To delete a bootable array:

1. From the Main menu, select **Manage Arrays**.
2. From the List of Arrays, select the bootable array (*) you want to delete, and press **Ctrl+B**. (* a bootable array is the array marked with an asterisk (as shown in the picture above.)
3. Enter Y to delete a bootable array when the following message is displayed: "The array is already marked bootable. Do you want to make this array as not bootable? (Yes/No):" Then, the bootable array will be deleted and the asterisk will disappear.

(*Note: do not use the delete key to delete the bootable array.)

Adding/Deleting Hotspares

(*Note: In order to rebuild a RAID (RAID 0 or RAID 1), you would need to add a new HDD as a hotspare.)

1. Turn on your computer and press Ctrl+A as prompted to access the ARC Utility.
2. From the ARC menu, select Array Configuration Utility (ACU).
3. From the ACU menu, select Add/Delete Hotspares.
4. Use the up and down arrow keys to highlight and select the disk you want to designate as a hotspare, and press <Insert>, and then, press <Enter>.
5. Press yes when the following prompt is displayed:

"Do you want to create spare?" (Yes/No?)

The spare you have selected will appear in the Select Drive Menu.

Initializing Disk Drives

If an installed disk does not appear in the disk selection list for creating a new array, or if it appears grayed out, you may have to initialize it before you can use it as part of an array. Drives attached to the controller must be initialized before they can be used in an array.

Caution: Initializing a disk overwrites the partition table on the disk and makes any data on the disk inaccessible. If the drive is used in an array, you may not be able to use the array again. **Do not** initialize a disk that is part of a boot array. To determine which disks are associated with a particular array, please refer to [Viewing Array Properties](#).

To initialize drives:

1. Turn on your computer and press **Ctrl+A** when prompted to access the ARC utility.
2. From the ARC menu, select **Array Configuration Utility (ACU)** (as shown in the screen below).

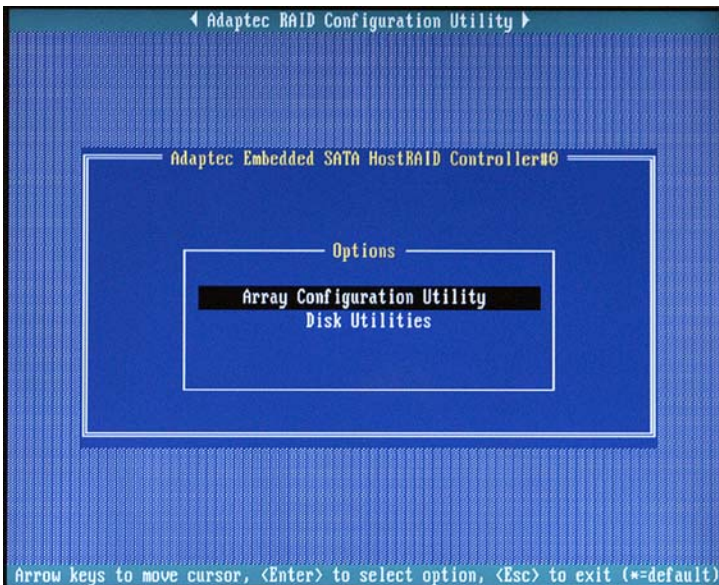

3. Select **Initialize Drives** (as shown in the screen below).

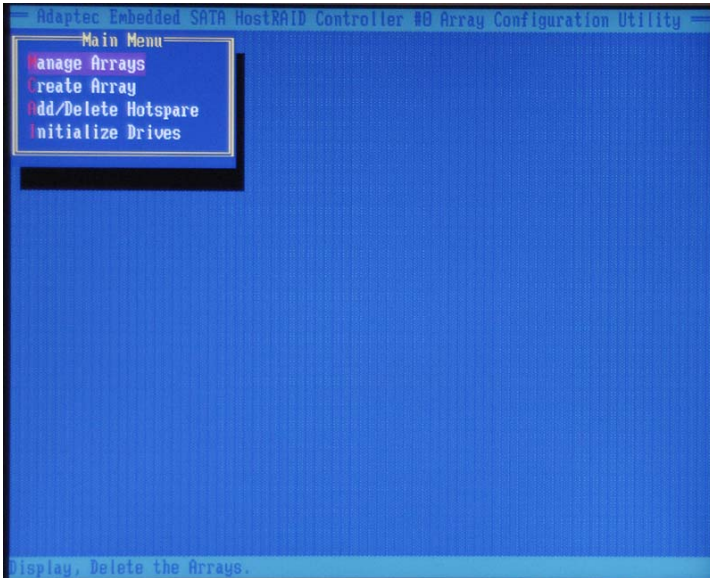

4. Use the up and down arrow keys to highlight the disk you wish to initialize and press **Insert** (as shown in the screen below).

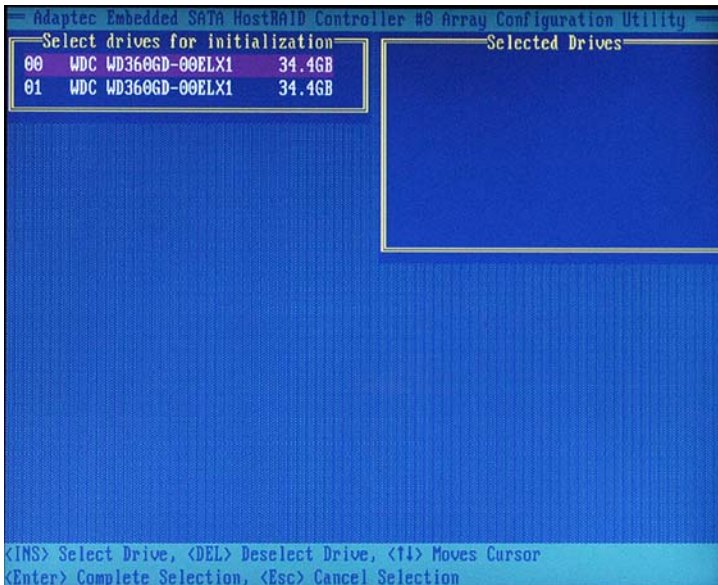

- Repeat [Step 4](#) so that both drives to be initialized are selected (as shown in the screen below).

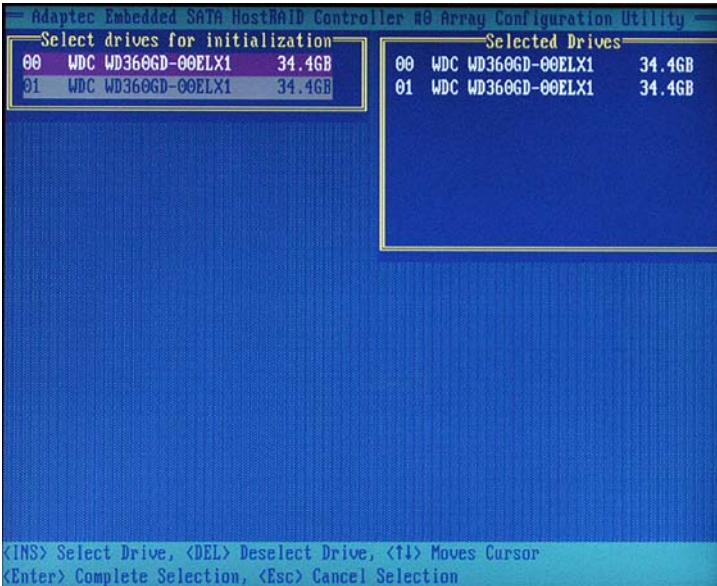

- Press **Enter**.
- Read the warning message as shown in the screen.

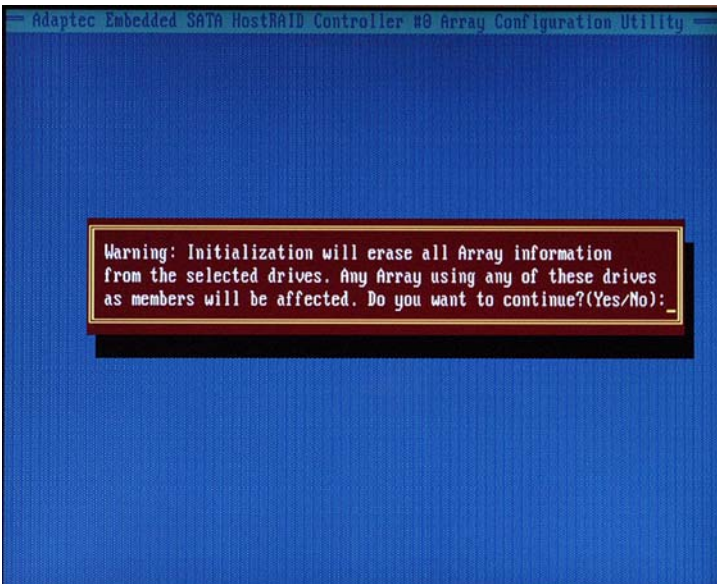

- Make sure that you have selected the correct disk drives to initialize. If correct, type **Y** to continue.

Rebuilding Arrays

***Note 1:** Rebuilding applies to Fault Tolerant array (RAID 1) only.

If an array Build process (or initialization) is interrupted or critical with one member missing, you must perform a Rebuild to optimized its functionality. For a critical array Rebuild operation, the optimal drive is the source drive.

***Note 2:** If no spare array exists and a hard disk drive fails, you need to create a spare before you can rebuild an array.

To Rebuild an array:

1 From the Main Menu, select **Manage Arrays** (as shown in the screen below). From the List of Arrays, select the array you want to Rebuild.

2 Press **Ctrl+R** to Rebuild.

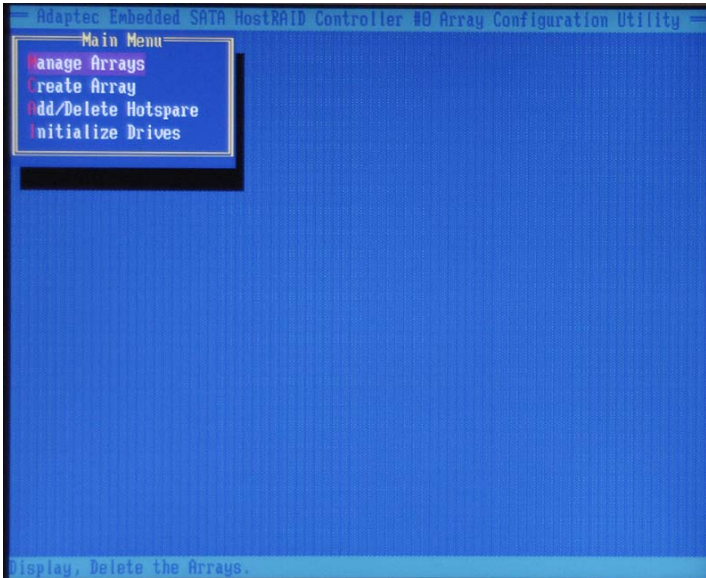

Using the Disk Utilities

The Disk Utilities enable you to format or verify the media of your Serial ATA hard disks.

To access the disk utilities:

1. Turn on your computer and press **Ctrl+A** when prompted to access the ARC utility (as shown in the screen below.)

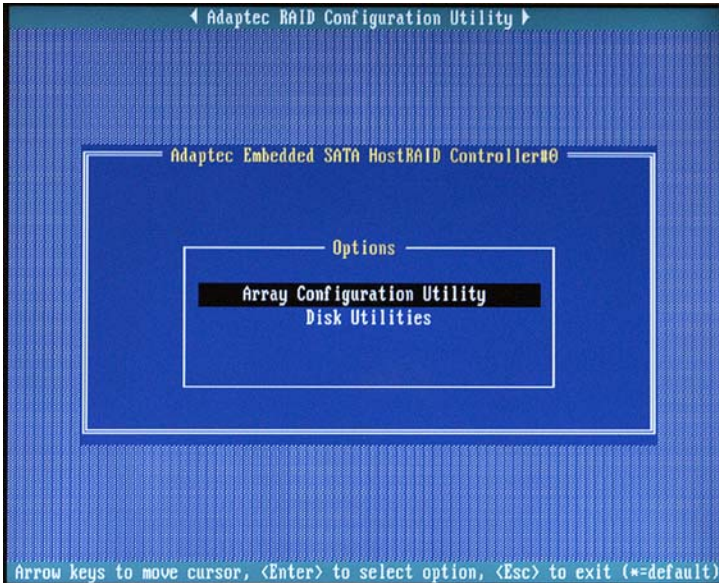

2. From the ARC menu, select **Disk Utilities** as shown in the screen below.

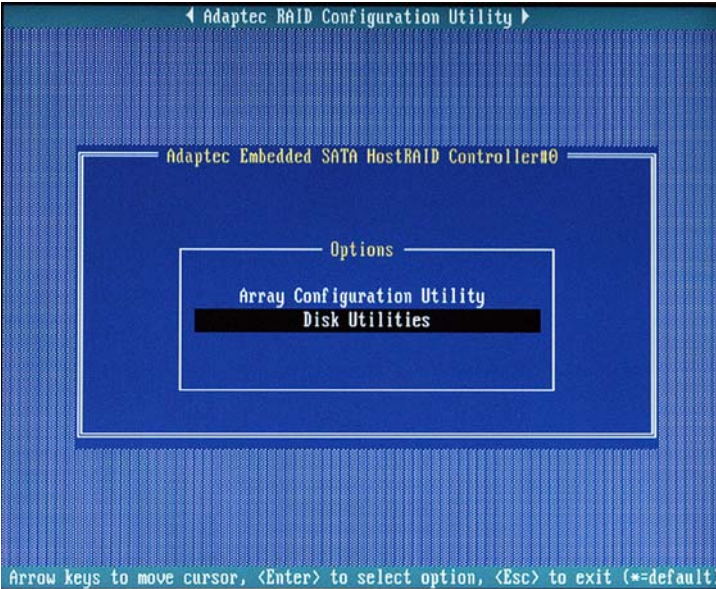

3 Select the desired disk and press **Enter** (as shown in the screen below.)

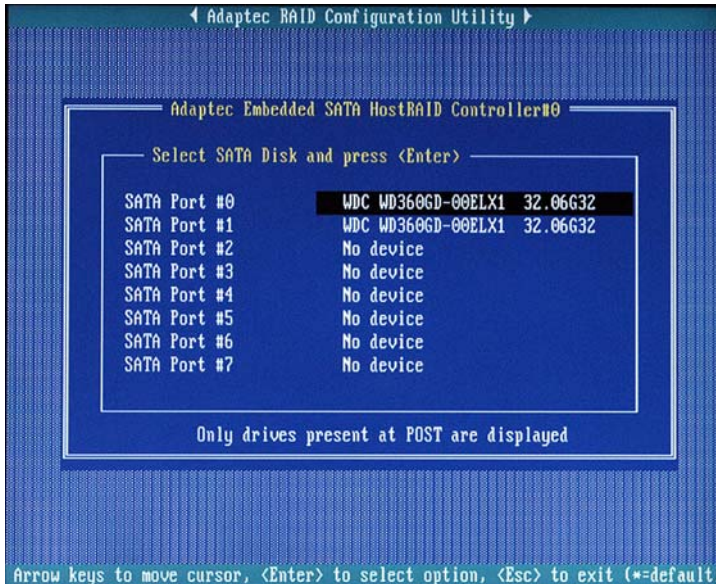

You can choose from the following options:

1. Format Disk—Simulates a low-level format of the hard drive by writing zeros to the entire disk. Serial ATA drives are low-level formatted at the factory and do not need to be low-level formatted again.

(***Caution:** Formatting destroys all data on the drive. Be sure to back up your data before performing this operation.)

2. Verify Disk Media—Scans the media of a disk drive for defects.

To Exit Adaptec RAID Configuration Utility

1. Once you have completed RAID array configurations, press **ESC** to exit. The following screen will appear.

2. Press **Yes** to exit the Utility.

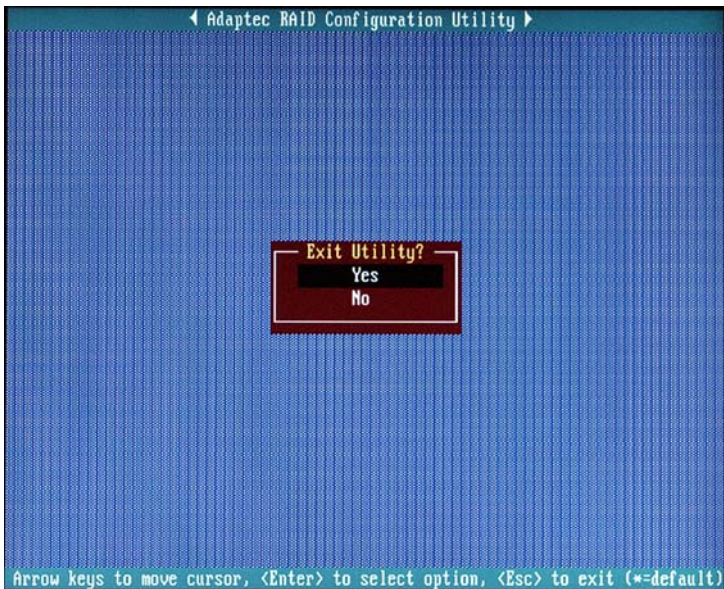

(*For more information regarding Adaptec RAID Utility, please refer to Adaptec's User's Guide in the CD included in your shipping package. You can also download a copy of Adaptec User's Guide from our web site at: www.supermicro.com.)

B-2 Installing Intel's ICH5R Driver by Adaptec and the OS

- a. Insert Supermicro's bootable CD that came with the package into the CD Drive during the system reboot, and the screen:"Super Micro Driver Diskette Maker" will appear.
- b. Choose from the list the item: "Intel ICH5R Driver by 3rd Party (Adaptec)" and press <ENTER>.
- c. From the next screen displayed, choose the OS driver you want to install and press <Enter>.
- d. Insert a formatted diskette into drive A: and press <Enter> as prompted.
- e. Exit the program after the process is completed. Then, reboot the system.
- f. Insert Microsoft Windows OS Setup CD in the CD Driver, and the system will start to boot up from CD.
- g. Press the <F6> key when the message-"Press F6 if you need to install a third party SCSI or RAID driver" displays.
- h. When the Windows OS Setup screen appears, press "S" to specify additional device(s).
- i. Insert the driver diskette-"Adaptec Embedded Serial ATA Raid Controller Driver" into Drive A: and press the <Enter> key.
- j. Choose Adaptec Embedded Host Serial ATA Raid Controller from the list indicated in the Windows OS Setup Screen, and press the <Enter> key.
- k. Press the <Enter> key to continue the installation process. (If you need to specify any additional devices to be installed, do it at this time.) Once all devices are specified, press the <Enter> key to continue with the installation.
- l. From the Windows OS Setup screen, press the <Enter> key. The OS Setup will automatically load all device files, and, then, continue the Windows OS installation.
- m. After Windows OS Installation is completed, the system will automatically reboot.

B-3 Installing Other Software Programs and Drivers

A. Installing Drivers other than Adaptec Embedded Serial ATA RAID Controller Driver

After you've installed Windows Operating System, a screen as shown below will appear. You are ready to install software programs and drivers that have not yet been installed. To install these software programs and drivers, click the icons to the right of these items.

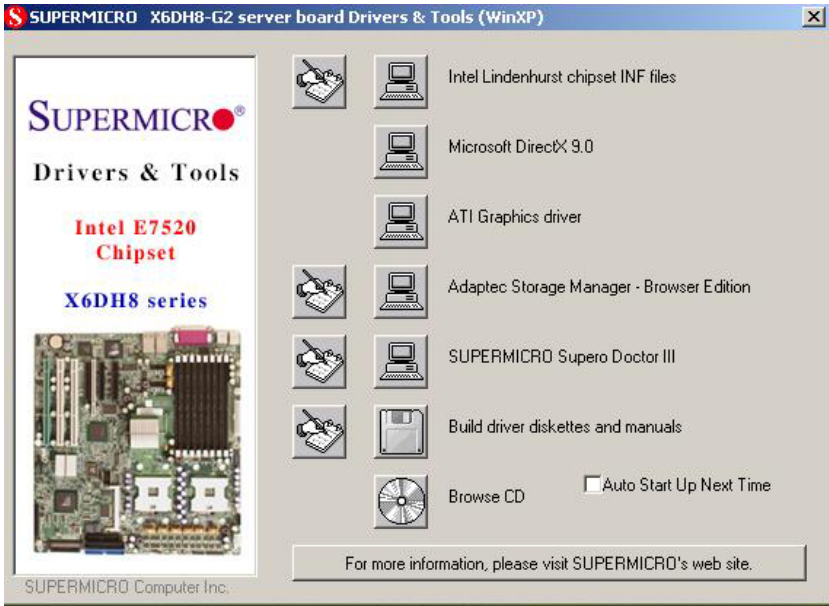

Driver/Tool Installation Display Screen

(*Note: Click the icons showing a hand writing on paper to view the readme files for each item. Click the computer icons to the right of these items to install each item (from top to the bottom) one at a time. **After installing each item, you must re-boot the system before moving on to the next item on the list.** You should install everything here except for the SUPER Doctor utility, Intel LDCM and the LAN/SCSI driver diskettes, which are optional. The bottom icon with a CD on it allows you to view the entire contents of the CD.)

(*Please refer to the Adaptec User's Guide for the installation of Adaptec's Serial ATA RAID Controller Driver. Adaptec's User's Guide is included in the CD. You can also download a copy of the user's guide from our web site.)

Supero Doctor III

The Supero Doctor III program is a Web base management tool that supports remote management capability. It includes Remote and Local Management tools. The local management is called SD III Client. The Supero Doctor III program included on the CDROM that came with your motherboard allows you to monitor the environment and operations of your system. Supero Doctor III displays crucial system information such as CPU temperature, system voltages and fan status. See the Figure below for a display of the Supero Doctor III interface.

Supero Doctor III Interface Display Screen-I (Health Information)

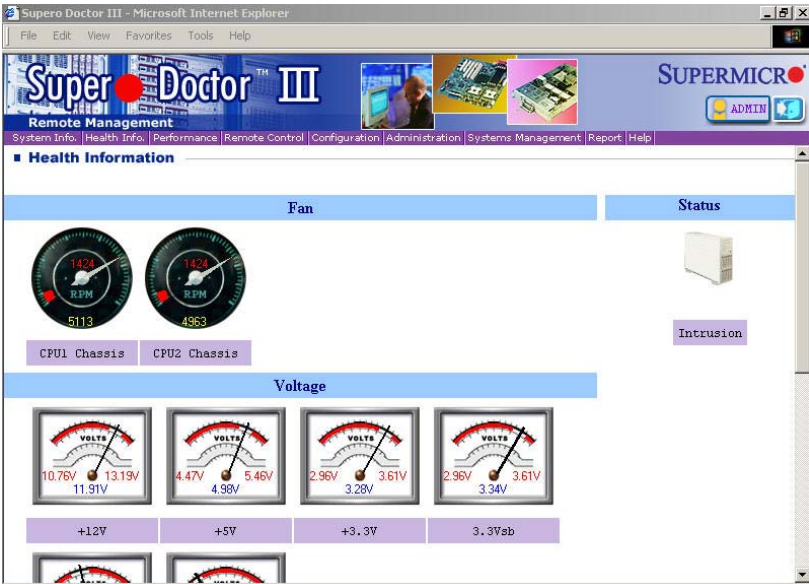

Supero Doctor III Interface Display Screen-II (Remote Control)

Graceful power control

Supero Doctor III allows a user to inform the OS to reboot or shut down within a specified time (the default is 30 seconds). Before the system reboots or shuts down, it's allowed to cancel the action.

Requirements

Keep Supero SD3Service Daemon running at all times on this system.
Provide TCP/IP connectivity.

Power control

(*Notes: 1. SD III Software Revision 1.0 can be downloaded from our Web site at: ftp://ftp.supermicro.com/utility/Supero_Doctor_III/. You can also download SDIII User's Guide at: <http://www.supermicro.com/PRODUCT/Manuals/SDIII/UserGuide.pdf>. For Linux, we will still recommend Supero Doctor II. 2. For detailed information on Adaptec's SCSI SATA HostRAID Utility, please refer to the CDs included in the shipping package.)

Notes

Free Manuals Download Website

<http://myh66.com>

<http://usermanuals.us>

<http://www.somanuals.com>

<http://www.4manuals.cc>

<http://www.manual-lib.com>

<http://www.404manual.com>

<http://www.luxmanual.com>

<http://aubethermostatmanual.com>

Golf course search by state

<http://golfingnear.com>

Email search by domain

<http://emailbydomain.com>

Auto manuals search

<http://auto.somanuals.com>

TV manuals search

<http://tv.somanuals.com>