

SUPER[®]

SUPER[®] X8DTG-DF

USER'S MANUAL

Revision 1.0

The information in this User's Manual has been carefully reviewed and is believed to be accurate. The vendor assumes no responsibility for any inaccuracies that may be contained in this document, makes no commitment to update or to keep current the information in this manual, or to notify any person or organization of the updates. **Please Note: For the most up-to-date version of this manual, please see our web site at www.supermicro.com.**

Super Micro Computer, Inc. ("Supermicro") reserves the right to make changes to the product described in this manual at any time and without notice. This product, including software, if any, and documentation may not, in whole or in part, be copied, photocopied, reproduced, translated or reduced to any medium or machine without prior written consent.

IN NO EVENT WILL SUPERMICRO BE LIABLE FOR DIRECT, INDIRECT, SPECIAL, INCIDENTAL, SPECULATIVE OR CONSEQUENTIAL DAMAGES ARISING FROM THE USE OR INABILITY TO USE THIS PRODUCT OR DOCUMENTATION, EVEN IF ADVISED OF THE POSSIBILITY OF SUCH DAMAGES. IN PARTICULAR, SUPERMICRO SHALL NOT HAVE LIABILITY FOR ANY HARDWARE, SOFTWARE, OR DATA STORED OR USED WITH THE PRODUCT, INCLUDING THE COSTS OF REPAIRING, REPLACING, INTEGRATING, INSTALLING OR RECOVERING SUCH HARDWARE, SOFTWARE, OR DATA.

Any disputes arising between manufacturer and customer shall be governed by the laws of Santa Clara County in the State of California, USA. The State of California, County of Santa Clara shall be the exclusive venue for the resolution of any such disputes. Super Micro's total liability for all claims will not exceed the price paid for the hardware product.

FCC Statement: This equipment has been tested and found to comply with the limits for a Class A digital device pursuant to Part 15 of the FCC Rules. These limits are designed to provide reasonable protection against harmful interference when the equipment is operated in a commercial environment. This equipment generates, uses, and can radiate radio frequency energy and, if not installed and used in accordance with the manufacturer's instruction manual, may cause harmful interference with radio communications. Operation of this equipment in a residential area is likely to cause harmful interference, in which case you will be required to correct the interference at your own expense.

California Best Management Practices Regulations for Perchlorate Materials: This Perchlorate warning applies only to products containing CR (Manganese Dioxide) Lithium coin cells. "Perchlorate Material-special handling may apply. See www.dtsc.ca.gov/hazardouswaste/perchlorate"

WARNING: Handling of lead solder materials used in this product may expose you to lead, a chemical known to the State of California to cause birth defects and other reproductive harm.

Manual Revision 1.0

Release Date: July 6, 2009

Unless you request and receive written permission from Super Micro Computer, Inc., you may not copy any part of this document.

Information in this document is subject to change without notice. Other products and companies referred to herein are trademarks or registered trademarks of their respective companies or mark holders.

Copyright © 2009 by Super Micro Computer, Inc.
All rights reserved.

Printed in the United States of America

Preface

About This Manual

This manual is written for system integrators, PC technicians and knowledgeable PC users. It provides information for the installation and use of the **SUPER** X8DTG-DF motherboard.

About This Motherboard

The **SUPER** X8DTG-DF motherboard supports the Intel 5500 Series Processor platform and the QuickPath Interconnect (QPI) Technology, providing the next generation point-to-point system interface that replaces the current Front Side Bus. With the 5500 Series Processor built in, the X8DTG-DF substantially enhances system performance with increased bandwidth and unprecedented scalability optimized for HPC/Cluster and high-end IU servers. Please refer to our web site (<http://www.supermicro.com/products/>) for updates on supported processors. This product is intended to be installed and serviced by professional technicians.

Manual Organization

Chapter 1 describes the features, specifications and performance of the motherboard and provides detailed information about the chipset.

Chapter 2 provides hardware installation instructions. Read this chapter when installing the processor, memory modules and other hardware components into the system. If you encounter any problems, see **Chapter 3**, which describes troubleshooting procedures for video, memory and system setup stored in the CMOS.

Chapter 4 includes an introduction to BIOS and provides detailed information on running the CMOS Setup utility.

Appendix A lists BIOS POST Error Codes. **Appendix B** and **Appendix C** provide the Windows OS and Other Software Installation Instructions.

Conventions Used in the Manual

Special attention should be given to the following symbols for proper installation and to prevent product damage or bodily injury:



Warning: Important information given to ensure proper system installation or to prevent damage to the components.



Note: Additional Information given to differentiate various models or to ensure correct system setup.

Contacting Supermicro

Headquarters

Address: Super Micro Computer, Inc.
980 Rock Ave.
San Jose, CA 95131 U.S.A.

Tel: +1 (408) 503-8000

Fax: +1 (408) 503-8008

Email: marketing@supermicro.com (General Information)
support@supermicro.com (Technical Support)

Web Site: www.supermicro.com

Europe

Address: Super Micro Computer B.V.
Het Sterrenbeeld 28, 5215 ML
's-Hertogenbosch, The Netherlands

Tel: +31 (0) 73-6400390

Fax: +31 (0) 73-6416525

Email: sales@supermicro.nl (General Information)
support@supermicro.nl (Technical Support)
rma@supermicro.nl (Customer Support)

Asia-Pacific

Address: Super Micro Computer, Inc.
4F, No. 232-1, Liancheng Rd.
Chung-Ho 235, Taipei County
Taiwan, R.O.C.

Tel: +886-(2) 8226-3990

Fax: +886-(2) 8226-3991

Web Site: www.supermicro.com.tw

Technical Support:

Email: support@supermicro.com.tw

Tel: 886-2-8228-1366, ext.132 or 139

Notes

Table of Contents

Preface

About This Manual	iii
About This Motherboard.....	iii
Manual Organization	iii
Conventions Used in the Manual.....	iii
Contacting Supermicro.....	iv

Chapter 1 Introduction

1-1 Overview	1-1
Checklist.....	1-1
Motherboard Features	1-6
1-2 Chipset Overview	1-9
Main Features of the 5500 Series Processor and the 5520 Chipset.....	1-9
1-3 Special Features	1-10
Recovery from AC Power Loss.....	1-10
1-4 PC Health Monitoring.....	1-10
Fan Status Monitor with Firmware Control	1-10
Environmental Temperature Control	1-10
System Resource Alert	1-10
1-5 ACPI Features.....	1-11
Slow Blinking LED for Suspend-State Indicator	1-11
Main Switch Override Mechanism	1-11
1-6 Power Supply	1-11
1-7 Overview of the Winbond WPCM450 Controller	1-12

Chapter 2 Installation

2-1 Static-Sensitive Devices.....	2-1
Precautions	2-1
Unpacking	2-1
2-2 Motherboard Installation.....	2-2
Tools Needed	2-2
Installation Instructions.....	2-2
2-3 Processor and Heatsink Installation.....	2-3
Installing a CPU Heatsink	2-5
2-4 Memory Installation	2-7
2-5 Control Panel Connectors/IO Ports.....	2-10
Back Panel Connectors/IO Ports	2-10
Back Panel Connector Pin Definitions.....	2-11

	Universal Serial Bus (USB).....	2-11
	Ethernet Ports	2-12
	Serial Ports.....	2-13
	Video Connector.....	2-13
	Unit Identifier Switches.....	2-14
	Front Control Panel.....	2-15
	Front Control Panel Pin Definitions.....	2-16
	Power LED	2-16
	HDD/FP UID Switch	2-16
	NIC1 LED Indicator	2-17
	NIC2 LED Indicator	2-17
	Overheat (OH)/Fan Fail/PWR Fail/UID LED	2-18
	Power Fail LED	2-18
	Reset Button	2-19
	Power Button	2-19
2-6	Connecting Cables.....	2-20
	20-pin Proprietary Main Power and 8-pin PCI-E Graphic Card Power Connectors	2-20
	Fan Headers.....	2-21
	NMI Header	2-22
	Internal Buzzer	2-22
	T-SGPIO Headers	2-23
	PWR I ² C (SMB) Connector	2-24
	IPMB I ² C SMB	2-24
2-7	Jumper Settings	2-25
	Explanation of Jumpers	2-25
	GLAN Enable/Disable	2-25
	CMOS Clear	2-26
	Watch Dog Enable/Disable	2-26
	VGA Enable.....	2-27
	J_UID_OW (-Overwriting)	2-28
2-8	Onboard Indicators.....	2-29
	GLAN LEDs.....	2-29
	Onboard Power LED	2-30
	BMC Activity LED	2-30
2-9	Serial ATA Connections.....	2-31
	Serial ATA Ports.....	2-31
 Chapter 3 Troubleshooting		
3-1	Troubleshooting Procedures	3-1

	Before Power On	3-1
	No Power	3-1
	No Video	3-2
	Losing the System's Setup Configuration.....	3-2
	Memory Errors	3-2
3-2	Technical Support Procedures	3-3
3-3	Frequently Asked Questions	3-3
3-4	Returning Merchandise for Service.....	3-4

Chapter 4 BIOS

4-1	Introduction.....	4-1
	Starting BIOS Setup Utility.....	4-1
	How To Change the Configuration Data	4-1
	Starting the Setup Utility	4-2
4-2	Main Setup	4-2
4-3	Advanced Setup Configurations.....	4-4
4-4	Security Settings	4-22
4-5	Boot Configuration	4-24
4-6	Exit Options.....	4-25
4-7	BIOS Recovery	4-26
	How to Recover the AMIBIOS Image (-the Main BIOS Block).....	4-26
	4.7.1 Boot Sector Recovery from a USB Device.....	4-26
	4.7.2 Boot Sector Recovery from an IDE CD-ROM	4-27
	4.7.3 Boot Sector Recovery from a Serial Port ("Serial Flash")	4-27

Appendix A BIOS Error Beep Codes

A-1	BIOS Error Beep Codes	A-1
-----	-----------------------------	-----

Appendix B Installing the Windows OS

B-1	Installing the Windows OS for a RAID System	B-1
B-2	Installing the Windows OS for a Non-RAID System.....	B-2

Appendix C Software Installation Instructions

C-1	Installing Software Programs.....	C-1
C-2	Configuring Supero Doctor III	C-2

Chapter 1

Introduction

1-1 Overview

Checklist

Congratulations on purchasing your computer motherboard from an acknowledged leader in the industry. Supermicro boards are designed with the utmost attention to detail to provide you with the highest standards in quality and performance. Check that the following items have all been included with your motherboard. If anything listed here is damaged or missing, contact your retailer.

The following items are included in the bulk package.

- One (1) Supermicro Mainboard
- One (1) Supermicro CD containing drivers and utilities

SUPER X8DTG-DF Motherboard Image



 **Note:** The drawings and pictures shown in this manual were based on the latest PCB Revision available at the time of publishing of the manual. The motherboard you've received may or may not look exactly the same as the graphics shown in the manual.

SUPER[®] X8DTG-DF Motherboard Layout

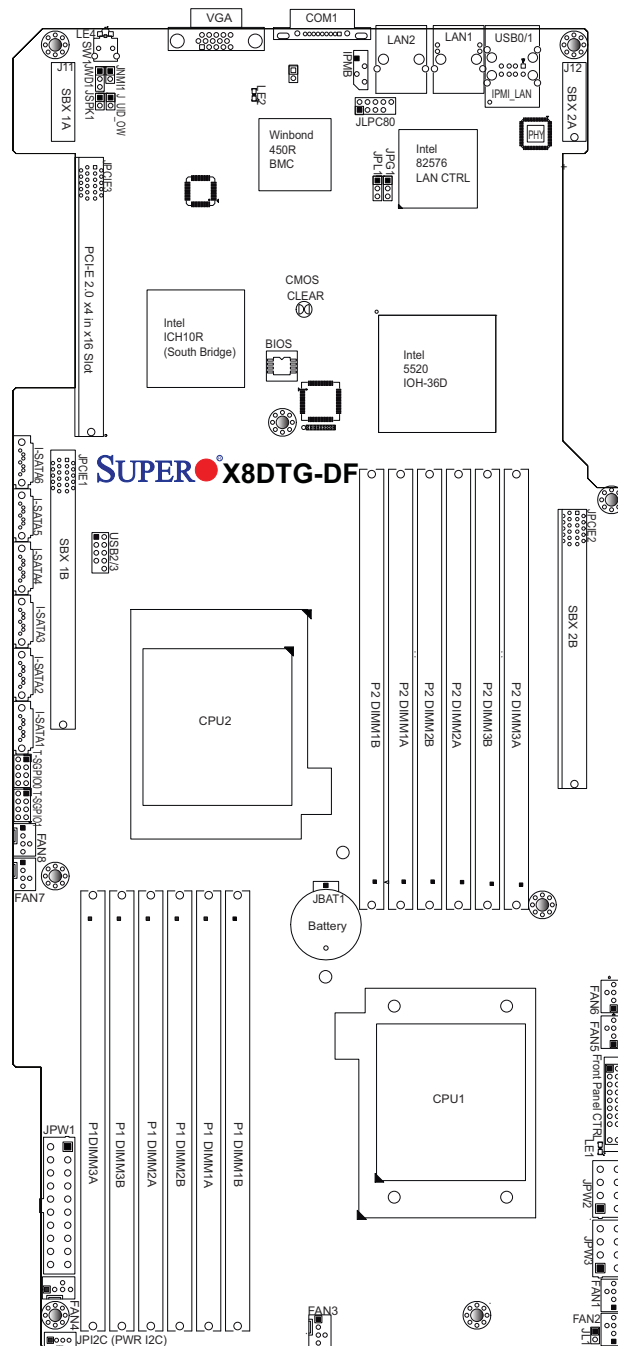

Notes:

1. Jumpers not indicated are for test purposes only. For more information on jumpers or components, refer to Chapter 2.
2. "■" indicates the location of Pin 1.
3. When LE1 LED is on, the onboard power connection is on. Make sure to unplug the power cables before removing or installing components.

SUPER X8DTG-DF Quick Reference

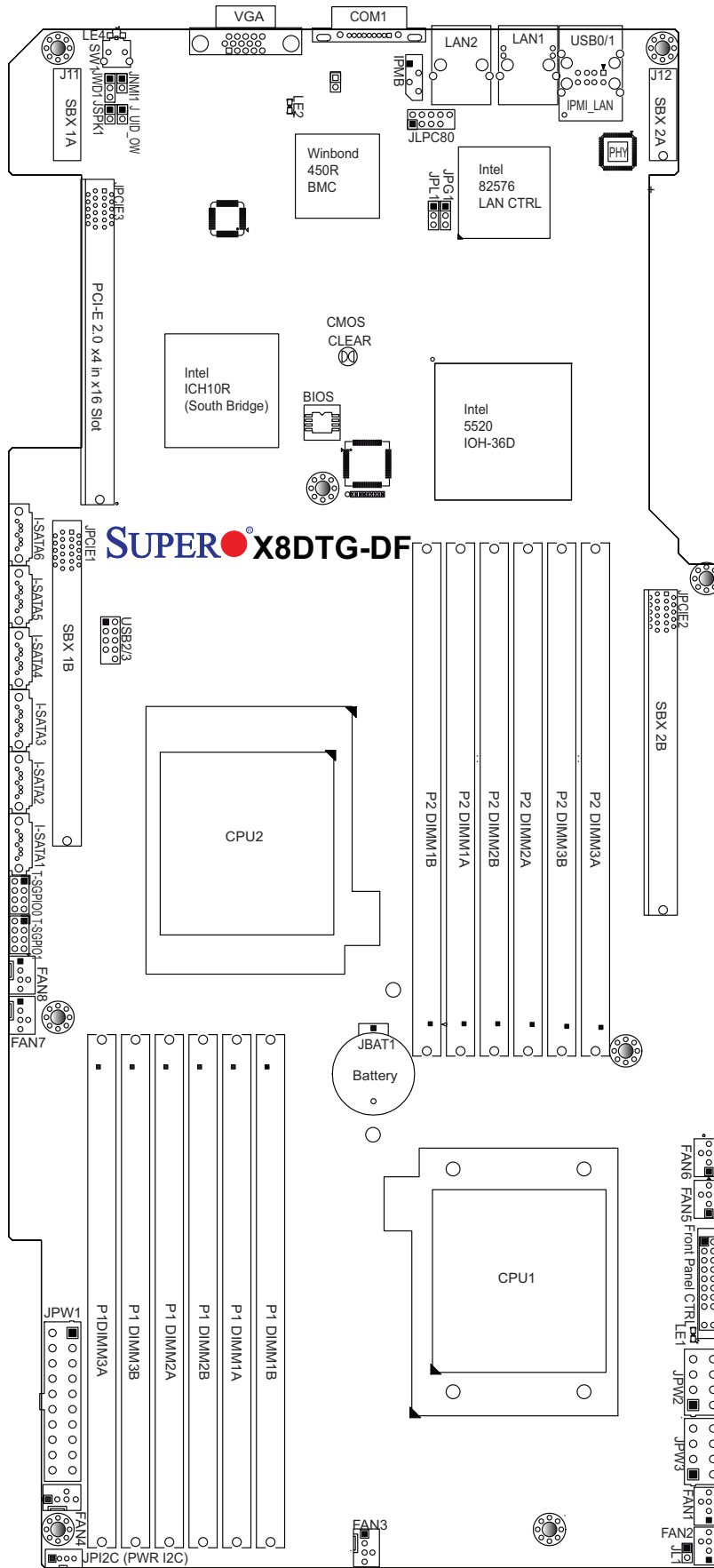

X8DTG-DF Quick Reference (See Chapter 2 for Details)

Jumper	Description	Default Setting
JBT1	CMOS Clear	(See Section 2-8)
JPG1	VGA Enable	Pins 1-2 (Enabled)
JPL1	LAN1/2 Enable	Pins 1-2 (Enabled)
J_UID_OW	Red LED OW (Pins 7/8 of JF1) (Page 2-31)	Off (Overwrites)
JWD1	Watch Dog	Pins 1-2 (Reset)

Connector	Description
COM1	COM1 Serial Port
FAN 1-8	System/CPU Fan Headers
IPMB	IPMB (SMB I ² C) Header (for IPMI)
JF1	Front Panel Connector
JL1	Chassis Intrusion
JLPC80	JLPC80 Connector
JNMI1	NMI (Non-Maskable Interrupt) Header
JPSK1	Internal Speaker/Buzzer Header
JPW1	12V 20-pin Power Connector (See Chpt. 2)
JPW2/JPW3	12V 8-pin PCI-Exp. Power Connectors (See Chpt. 2)
LAN1/2	Gigabit Ethernet (RJ45) Ports
(IPMI dedicated) LAN	LAN (RJ45) Port for IPMI 2.0
PCI-E Slot	PCI-Express 2.0 x4 in x 16 slot (JPCIE3)
PWR I ² C (JPI ² C)	Power SMB (System Management Bus) I ² C Header
SATA1 ~ SATA6	(Intel South Bridge) SATA Ports
SBX 1A/2A Slots	PCI-E slots GPU for (Graphics Processing Unit) support (J11/J12)
SBX 1B/2B Slots	PCI-E slots for GPU support (JPCIE1/JPCIE2)
SW1	Unit Identifier Switch
T-SGPIO-0/T-SGPIO-1	Serial General Purpose Input/Output Headers
USB0/1, USB 2/3	Universal Serial Bus (USB) Ports 0/1, 2/3
VGA	Video Port

LED	Description
LE1	Onboard Standby PWR warning LED Indicator
LE2	BMC LED Indicator
LE4	(Rear) Unit Identifier (UID) LED Indicator



Warning: To avoid possible system overheating, please be sure to provide adequate airflow to your system.

Motherboard Features

CPU

- Two Intel[®] 5500 Series (LGA 1366) processors with each processor supporting two full-width Intel QuickPath Interconnect (QPI) links with a total of up to 51.2 GT/s Data Transfer Rate (6.4 GT/s per direction)

Memory

- Twelve 240-pin DIMM sockets support up to 96 GB of Registered ECC or 24 GB of Unbuffered ECC/Non-ECC DDR3 1333/1066/800 MHz Memory. (For Unbuffered ECC/Non-ECC memory, maximum of 2 GB per DIMM is supported. See Pages 2-7, 2-8 in Chapter 2 for memory Population.)

Chipset

- Intel 5520 chipset, including: the 5520 (IOH-36D) and the ICH10R (South Bridge).

Expansion Slot

- One PCI-E x4 Gen. 2.0 in x16 slot

SMC Proprietary Slots

- Four SBX slots (SBX 1A/2A & SBX 1B/2B) for riser cards (Refer to www.supermicro.com/support/resources/riser/ for details.)

BIOS

- 32 Mb AMI SPI Flash ROM
- ACPI 1.0/2.0/3.0, Plug and Play (PnP), DMI 2.3, SMBIOS 2.3, and USB Keyboard support

PC Health Monitoring

- Onboard voltage monitors for CPU1 VCore, CPU2 VCore, +5Vin, +12Vcc (V), V P1 DIMM, V P2 DIMM, +3.3Vcc (V), and Battery Voltage
 - Fan status monitor with firmware control
 - CPU/chassis temperature monitors
 - Platform Environment Control Interface (PECI) ready
 - CPU fan auto-off in sleep mode
 - CPU slow-down on temperature overheat
 - Pulse Width Modulation (PWM) Fan Control
 - CPU thermal trip support for processor protection, power LED
 - Power-up mode control for recovery from AC power loss
 - Auto-switching voltage regulator for CPU cores
 - System overheat/Fan Fail LED Indicator and control
 - System resource alert via Supero Doctor III
-

ACPI Features

- Slow blinking LED for suspend state indicator
- Main switch override mechanism
- ACPI Power Management
- Keyboard Wakeup from Soft-off

Onboard I/O

- Intel ICH10R supports six SATA ports (RAID0, RAID1, RAID10, RAID5 supported in the Windows OS Environment and RAID 0, RAID 1, RAID 10 supported by the Linux OS)
- Winbond WPCM450 BMC (Baseboard Management Controller) supports IPMI 2.0 with KVM support
- Intel 82576 Dual-LAN Gigabit Ethernet Controller supports dual Giga-bit LAN ports
- Onboard PHY Chip supports IPMI dedicated LAN
- One COM port
- Up to four USB 2.0 (Universal Serial Bus) connections (2 Ports and 2 Front Headers)
- Super I/O: Winbond W83527HG

Other

- Console redirection
- Onboard Fan Speed Control by Thermal Management via BIOS

CD/Diskette Utilities

- BIOS flash upgrade utility and device drivers

Dimensions

- Proprietary 16.64" (L) x 7.71" (W) (422.66 mm x 195.83 mm)

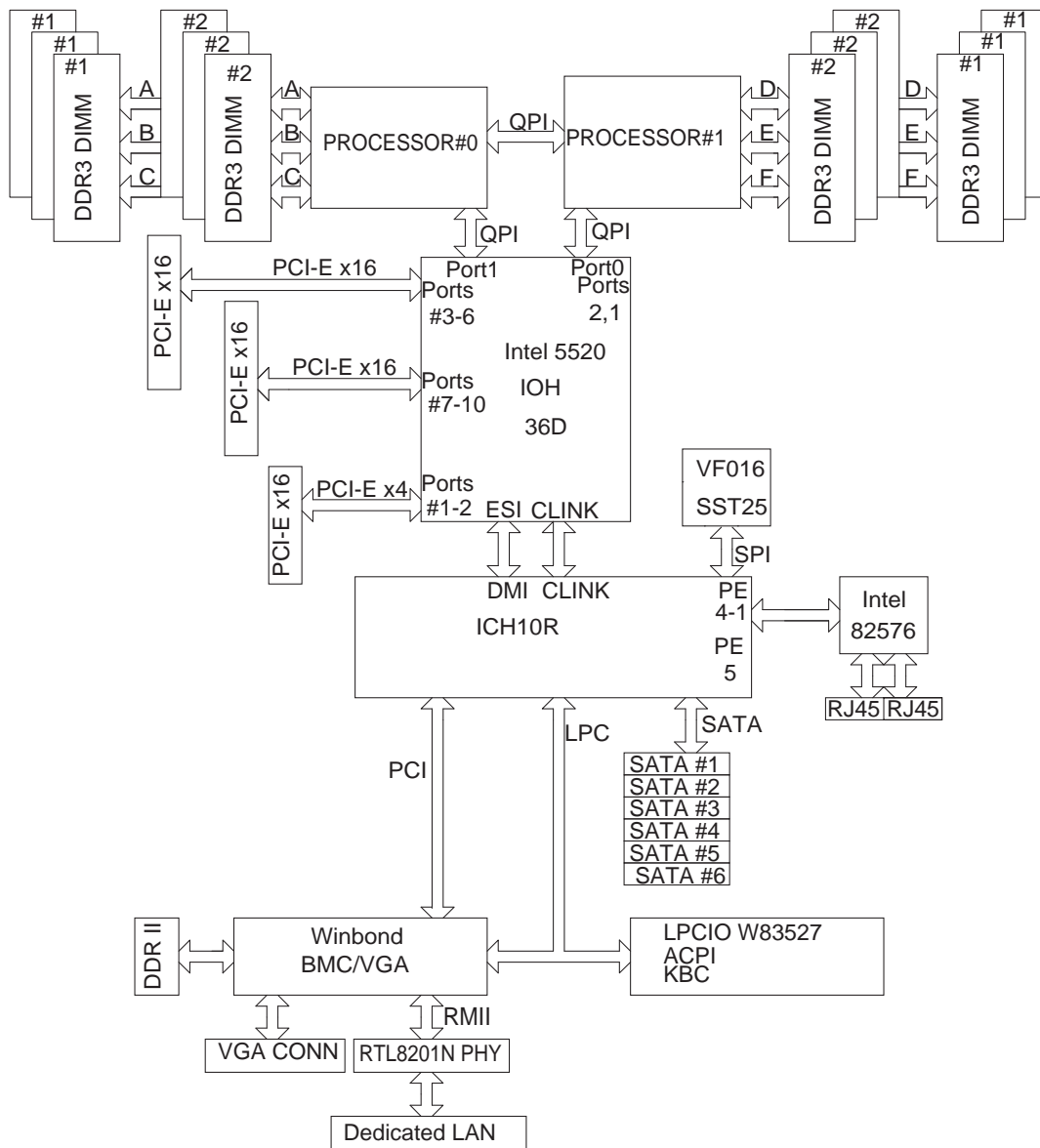

Block Diagram of the 5500 Series Processor Platform

 **Note:** This is a general block diagram. Please see the previous Motherboard Features pages for details on the features of each motherboard.

1-2 Chipset Overview

Built upon the functionality and the capability of the 5500 Series Processor, the X8DTG-DF motherboard provides the performance and feature set required for dual-processor-based systems with configuration optimized for intensive applications, High Performance Computing (HPC)/Cluster IU server platforms. The Intel 5520 platform consists of the 5500 Series (LGA 1366) processor, the 5520 (IOH-36D), and the ICH10R (South Bridge). With the Intel QuickPath interconnect (QPI) controller built in, the 5500 Series Processor platform is the first dual-processing platform to offer the next generation point-to-point system interconnect that replaces the current Front Side Bus Technology, substantially enhancing system performance by utilizing serial link interconnections with increased bandwidth and scalability.

The IOH connects to each processor through an independent QPI (QuickPath interconnect) link. Each link consists of 20 pairs of unidirectional differential lanes for transmission and receiving in addition to a differential forwarded clock. A full-width QPI link pair provides 84 signals. Each processor supports two QuickPath links, one going to the other processor and the other to the 5520 chips.

The 5520 chipset supports PCI Express Gen2 lanes peer-to-peer read and write transactions. The ICH10R provides multiple PCI-Express SATA and USB connections.

In addition, the 5520 platform also offers a wide range of RAS (Reliability, Availability and Serviceability) features. These features include memory interface ECC, x4/x8 Single Device Data Correction (SDDC), Cyclic Redundancy Check (CRC), parity protection, out-of-band register access via SMBus, memory mirroring, memory sparing, and Hot-plug support on the PCI-Express Interface.

Main Features of the 5500 Series Processor and the 5520 Chipset

- Four processor cores in each processor with 8MB shared cache among cores
- Two full-width Intel QuickPath interconnect links, up to 6.4 GT/s of data transfer rate in each direction
- Virtualization Technology, Integrated Management Engine supported
- Point-to-point cache coherent interconnect, Fast/narrow unidirectional links, and Concurrent bi-directional traffic

1-3 Special Features

Recovery from AC Power Loss

BIOS provides a setting for you to determine how the system will respond when AC power is lost and then restored to the system. You can choose for the system to remain powered off (in which case you must press the power switch to turn it back on) or for it to automatically return to a power-on state. See the Advanced BIOS Setup section to change this setting. The default setting is **Last State**.

1-4 PC Health Monitoring

This section describes the PC health monitoring features of the X8DTG-DF. All have an onboard System Hardware Monitor chip that supports PC health monitoring. An onboard voltage monitor will scan these onboard voltages continuously: CPU1 VCore, CPU2 VCore, +5Vin, +12Vcc (V), V P1 DIMM, V P2 DIMM, +3.3Vcc (V), and Battery Voltage. Once a voltage becomes unstable, a warning is given or an error message is sent to the screen. Users can adjust the voltage thresholds to define the sensitivity of the voltage monitor.

Fan Status Monitor with Firmware Control

The PC health monitor can check the RPM status of the cooling fans. The onboard CPU and chassis fans are controlled by Thermal Management via BIOS (under Hardware Monitoring in the Advanced Setting).

Environmental Temperature Control

The thermal control sensor monitors the CPU temperature in real time and will turn on the thermal control fan whenever the CPU temperature exceeds a user-defined threshold. The overheat circuitry runs independently from the CPU. Once it detects that the CPU temperature is too high, it will automatically turn on the thermal fan control to prevent any overheat damage to the CPU. The onboard chassis thermal circuitry can monitor the overall system temperature and alert users when the chassis temperature is too high.



To avoid possible system overheating, please be sure to provide adequate airflow to your system.

System Resource Alert

This feature is available when used with Supero Doctor III in the Windows OS environment or used with Supero Doctor II in Linux. Supero Doctor is used to notify the user of certain system events. For example, you can also configure

Supero Doctor to provide you with warnings when the system temperature, CPU temperatures, voltages and fan speeds go beyond a pre-defined range.

1-5 ACPI Features

ACPI stands for Advanced Configuration and Power Interface. The ACPI specification defines a flexible and abstract hardware interface that provides a standard way to integrate power management features throughout a PC system, including its hardware, operating system and application software. This enables the system to automatically turn on and off peripherals such as CD-ROMs, network cards, hard disk drives and printers.

In addition to enabling operating system-directed power management, ACPI provides a generic system event mechanism for Plug and Play and an operating system-independent interface for configuration control. ACPI leverages the Plug and Play BIOS data structures while providing a processor architecture-independent implementation that is compatible with Windows XP/Windows 2003/Windows 2008/Windows Vista Operating Systems.

Slow Blinking LED for Suspend-State Indicator

When the CPU goes into a suspend state, the chassis power LED will start blinking to indicate that the CPU is in suspend mode. When the user presses any key, the CPU will wake-up and the LED will automatically stop blinking and remain on.

Main Switch Override Mechanism

When an ATX power supply is used, the power button can function as a system suspend button to make the system enter a SoftOff state. The monitor will be suspended and the hard drive will spin down. Pressing the power button again will cause the whole system to wake-up. During the SoftOff state, the ATX power supply provides power to keep the required circuitry in the system "alive." In case the system malfunctions and you want to turn off the power, just press and hold the power button for 4 seconds. This option can be set in the Power section of the BIOS Setup routine.

1-6 Power Supply

As with all computer products, a stable power source is necessary for proper and reliable operation. It is even more important for processors that have high CPU clock rates.

It is strongly recommended that you use a high quality power supply that meets ATX power supply Specification 2.02 or above. It must also be SSI compliant (For more

information, please refer to the web site at <http://www.ssiforum.org/>). Additionally, in areas where noisy power transmission is present, you may choose to install a line filter to shield the computer from noise. It is recommended that you also install a power surge protector to help avoid problems caused by power surges.



Note 1. For the proprietary 20-pin main power connector (JPW1) and the 8-pin PCI-Exp. Graphic card power connectors (JPW2/JPW3) to work properly, please customize your power cables based on the SMC PWR Connector Pin-Out Definitions listed in the tables on Page 2-20 in Chapter 2.

2. For the PCI-Exp. Graphic cards to work properly, please connect the PCI-E graphic card power connectors (JPW2/JPW3) to the power supply.

1-7 Overview of the Winbond WPCM450 Controller

The Winbond WPCM450, a Baseboard Management Controller (BMC), supports the 2D/VGA-compatible Graphics Core with the PCI interface, Virtual Media, and Keyboard/Video/Mouse (KVM) Redirection modules.

The WPCM450 BMC interfaces with the host system via a PCI interface to communicate with the graphics core. It supports USB 2.0 and 1.1 for remote keyboard/mouse/virtual media emulation. It also provides LPC interface to control Super IO functions. The WPCM450 is connected to the network via an external Ethernet PHY module.

The WPCM450 communicates with onboard components via six SMBus interfaces, fan control, Platform Environment Control Interface (PECI) buses.



Note: For more information on IPMI configuration, please refer to the Embedded IPMI User's Guide posted on our website @ <http://www.supermicro.com/support/manuals/>.

Chapter 2

Installation

2-1 Static-Sensitive Devices

Electrostatic Discharge (ESD) can damage electronic components. To prevent damage to your system board, it is important to handle it very carefully. The following measures are generally sufficient to protect your equipment from ESD.

Precautions

- Use a grounded wrist strap designed to prevent static discharge.
- Touch a grounded metal object before removing the board from the antistatic bag.
- Handle the board by its edges only; do not touch its components, peripheral chips, memory modules or gold contacts.
- When handling chips or modules, avoid touching their pins.
- Put the motherboard and peripherals back into their antistatic bags when not in use.
- For grounding purposes, make sure your computer chassis provides excellent conductivity between the power supply, the case, the mounting fasteners and the motherboard.
- Use only the correct type of onboard CMOS battery as specified by the manufacturer. Do not install the onboard battery upside down to avoid possible explosion.



Unpacking

The motherboard is shipped in antistatic packaging to avoid static damage. When unpacking the board, make sure the person handling it is static protected.

2-2 Motherboard Installation

All motherboards have standard mounting holes to fit different types of chassis. Make sure that the locations of all the mounting holes for both motherboard and chassis match. Although a chassis may have both plastic and metal mounting fasteners, metal ones are highly recommended because they ground the motherboard to the chassis. Make sure that the metal standoffs click in or are screwed in tightly. Then use a screwdriver to secure the motherboard onto the motherboard tray. **Note:** Some components are very close to the mounting holes. Please take precautionary measures to prevent damage to these components when installing the motherboard to the chassis.

Tools Needed

1. Phillips Screwdriver 
2. Pan head #6 screws 

Installation Instructions

1. Install the IO shield into the chassis.
2. Locate the mounting holes on the motherboard. Refer to the layout above for mounting hole locations.
3. Locate the matching mounting holes on the chassis. Align the mounting holes on the motherboard against the mounting holes on the chassis.
4. Install standoffs in the chassis as needed.
5. Install the motherboard into the chassis carefully to avoid damage to motherboard components.

 **Warning:** To avoid damaging the motherboard and its components, please do not apply any force greater than 8 *lb/sq.in* (8 lbs. per square inch) when installing a screw into a mounting hole.

6. Insert a Pan head #6 screw into a mounting hole on the motherboard and its matching mounting hole on the chassis, using a Phillips screwdriver.
7. Repeat Step 4 to insert #6 screws to all mounting holes.
8. Make sure that the motherboard is securely placed on the chassis.

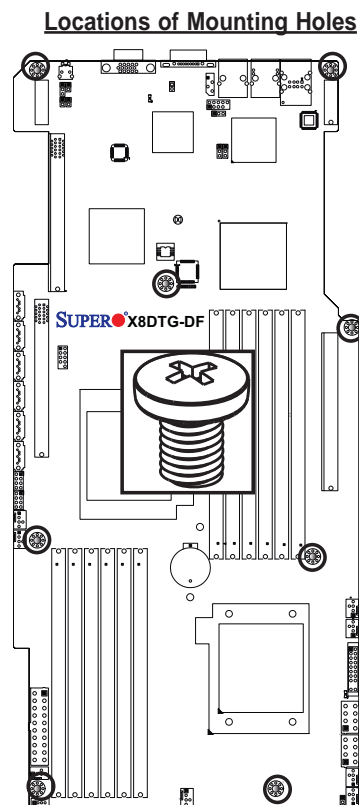

2-3 Processor and Heatsink Installation



When handling the processor package, avoid placing direct pressure on the label area of the fan.

Notes:

1. Always connect the power cord last and always remove it before adding, removing or changing any hardware components. Make sure that you install the processor into the CPU socket before you install the CPU heatsink.
2. Make sure to install the motherboard into the chassis before you install the CPU heatsink and heatsink fans.
3. When purchasing a motherboard without the 5500 Series processor pre-installed, make sure that the CPU socket plastic cap is in place, and none of the CPU socket pins are bent; otherwise, contact the retailer immediately.
4. Refer to the MB Features Section for more details on CPU support.

Installing an LGA 1366 Processor

1. Press the socket clip to release the load plate, which covers the CPU socket, from its locking position.
2. Gently lift the socket clip to open the load plate.
3. Hold the plastic cap at its north and south center edges to remove it from the CPU socket.



Socket Clip **Load Plate**



Plastic Cap

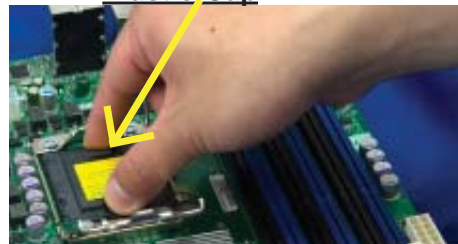

Hold the north & south edges of the plastic cap to remove it

4. After removing the plastic cap, using your thumb and the index finger, hold the CPU at the north and south center edges.
5. Align the CPU key, the semi-circle cutout, against the socket key, the notch below the gold color dot on the side of the socket.
6. Once both the CPU and the socket are aligned, carefully lower the CPU straight down into the socket. (Do not rub the CPU against the surface of the socket or its pins to avoid damaging the CPU or the socket.)
7. With the CPU inside the socket, inspect the four corners of the CPU to make sure that the CPU is properly installed.
8. Once the CPU is securely seated on the socket, lower the CPU load plate to the socket.
9. Use your thumb to gently push the socket clip down to the clip lock.

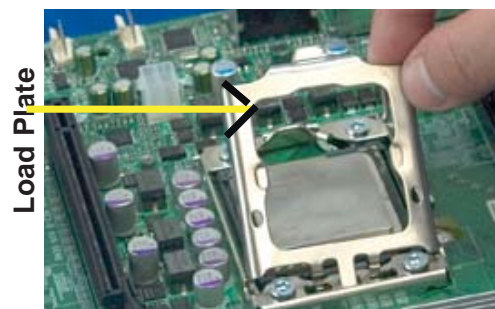
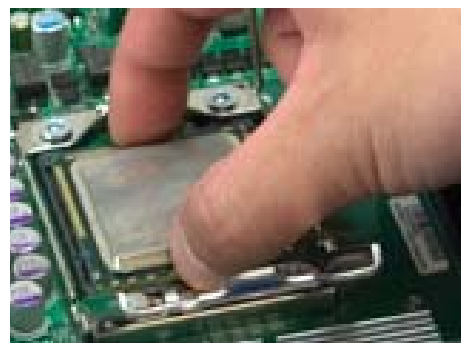
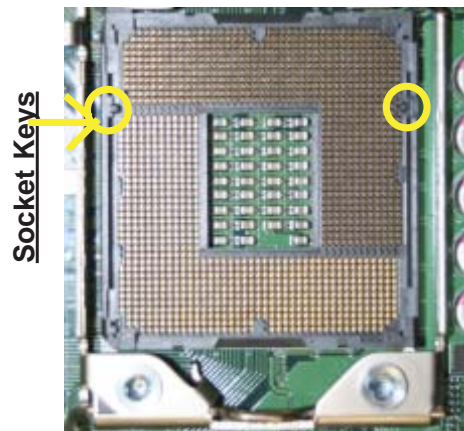
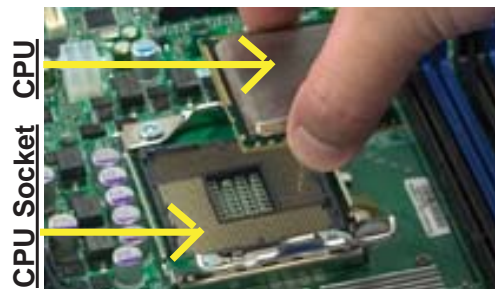

Warning: Please save the plastic cap. The motherboard must be shipped with the plastic cap properly installed to protect the CPU socket pins. Shipment without the plastic cap properly installed will cause damage to the socket pins.

Installing a CPU Heatsink

1. Do not apply any thermal grease to the heatsink or the CPU die because the required amount has already been applied.
2. Place the heatsink on top of the CPU so that the four mounting holes are aligned with those on the retention mechanism.
3. Install two diagonal screws (ie the #1 and the #2 screws) and tighten them until just snug (-do not fully tighten the screws to avoid possible damage to the CPU.)
4. Finish the installation by fully tightening all four screws.

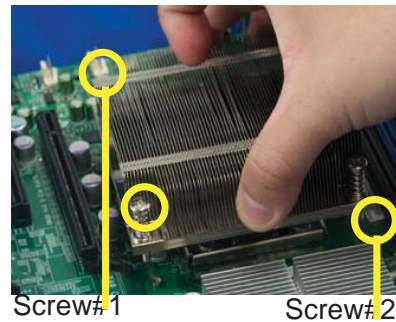
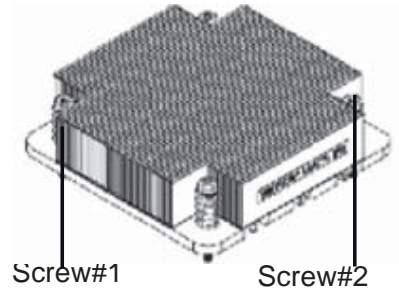

Install Screw#1

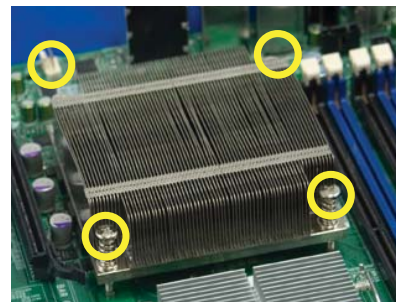
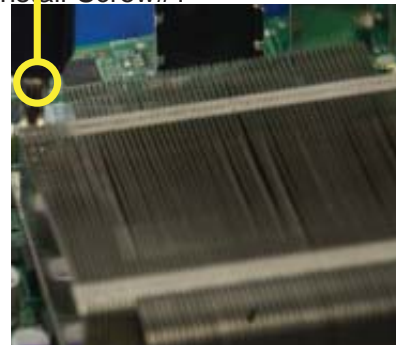

Removing the Heatsink



Warning: We do not recommend that the CPU or the heatsink be removed. However, if you do need to remove the heatsink, please follow the instructions below to uninstall the heatsink and prevent damage to the CPU or other components.

1. Unplug the power cord from the power supply.
2. Disconnect the heatsink fan wires from the CPU fan header.
3. Using a screwdriver, loosen and remove the heatsink screws from the motherboard in the sequence as show in the picture on the right.
4. Hold the heatsink as shown in the picture on the right and gently wriggle the heatsink to loosen it from the CPU. (Do not use excessive force when wriggling the heatsink.)
5. Once the heatsink is loosened, remove it from the CPU socket.
6. To reinstall the CPU and the heatsink, clean the surface of the CPU and the heatsink to get rid of the old thermal grease. Reapply the proper amount of thermal grease on the surface before reinstalling them on the motherboard.

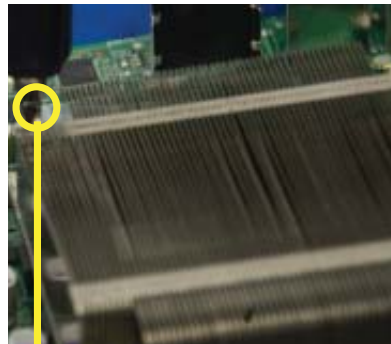

Using a screwdriver to remove Screw#1

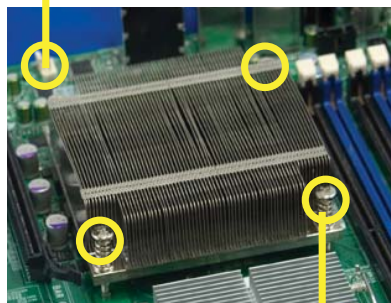

Remove Screw#2



2-4 Memory Installation

Note: Check the Supermicro web site for recommended memory modules.

CAUTION



Exercise extreme care when installing or removing DIMM modules to prevent any possible damage. Also note that the memory is interleaved to improve performance (See step 1).

DIMM Installation

1. Insert the desired number of DIMMs into the memory slots, starting with P1-DIMM 1A. For best memory performance, please install memory modules of the same type and same speed on the memory slots as indicated on the tables below. (See the Memory Installation Table Below.)
2. Insert each DIMM module vertically into its slot. Pay attention to the notch along the bottom of the module to prevent inserting the DIMM module incorrectly.
3. Gently press down on the DIMM module until it snaps into place in the slot. Repeat for all modules.

Memory Population for Optimal Performance -For a motherboard with One CPU (CPU1) installed						
	Branch 0		Branch 1		Branch 2	
3 DIMMs	P1 DIMM1A		P1 DIMM2A		P1 DIMM3A	
6 DIMMs	P1 DIMM1A	P1 DIMM1B	P1 DIMM2A	P1 DIMM2B	P1 DIMM3A	P1 DIMM3B

Memory Population for Optimal Performance -For a motherboard with One CPU (CPU2) installed						
	Branch 0		Branch 1		Branch 2	
3 DIMMs	P2 DIMM1A		P2 DIMM2A		P2 DIMM3A	
6 DIMMs	P2 DIMM1A	P2 DIMM1B	P2 DIMM2A	P2 DIMM2B	P2 DIMM3A	P2 DIMM3B

Memory Population for Optimal Performance -For a motherboard with Two CPUs installed												
	CPU1						CPU2					
	Branch 0		Branch 1		Branch 3		Branch 0		Branch 1		Branch 3	
6 DIMMs	1A		2A		3A		1A		2A		3A	
12 DIMMs	1A	1B	2A	2B	3A	3B	1A	1B	2A	2B	3A	3B

Memory Support

The X8DTG-DF supports up to 96 GB of Registered ECC or up to 24 GB of Unbuffered ECC/Non-ECC DDR3 1333/1066/800 MHz Memory in 12 DIMMs.



Note1: With Unbuffered ECC/Non ECC memory, maximum of 2 GB of memory is supported per DIMM slot.

Note 2: memory speed support is dependent on the type of CPU used on the board.

DIMM Module Population Configuration

For memory to work properly, follow the tables below for memory installation:

DIMM Population Table				
DIMM Slots per Channel	DIMMs Populated per Channel	DIMM Type (Reg.= Registered)	Speeds (in MHz)	Ranks per DIMM (any combination; SR=Single Rank, DR=Dual Rank, QR=Quad Rank)
2	1	Reg. DDR3 ECC	800,1066,1333	SR or DR
2	1	Reg. DDR3 ECC	800,1066	QR
2	2	Reg. DDR3 ECC	800,1066	Mixing SR, DR
2	2	Reg. DDR3 ECC	800	Mixing SR, DR,QR



Note 1: Due to OS limitations, some operating systems may not show more than 4 GB of memory.

Note 2: Due to memory allocation to system devices, the amount of memory that remains available for operational use will be reduced when 4 GB of RAM is used. The reduction in memory availability is disproportional.

Possible System Memory Allocation & Availability		
System Device	Size	Physical Memory Available (4 GB Total System Memory)
Firmware Hub flash memory (System BIOS)	1 MB	3.99 GB
Local APIC	4 KB	3.99 GB
Area Reserved for the chipset	2 MB	3.99 GB
I/O APIC (4 Kbytes)	4 KB	3.99 GB
PCI Enumeration Area 1	256 MB	3.76 GB
PCI Express (256 MB)	256 MB	3.51 GB
PCI Enumeration Area 2 (if needed) -Aligned on 256-M boundary-	512 MB	3.01 GB
VGA Memory	16 MB	2.85 GB
TSEG	1 MB	2.84 GB
Memory available for the OS & other applications		2.84 GB

Installing and Removing DIMMs

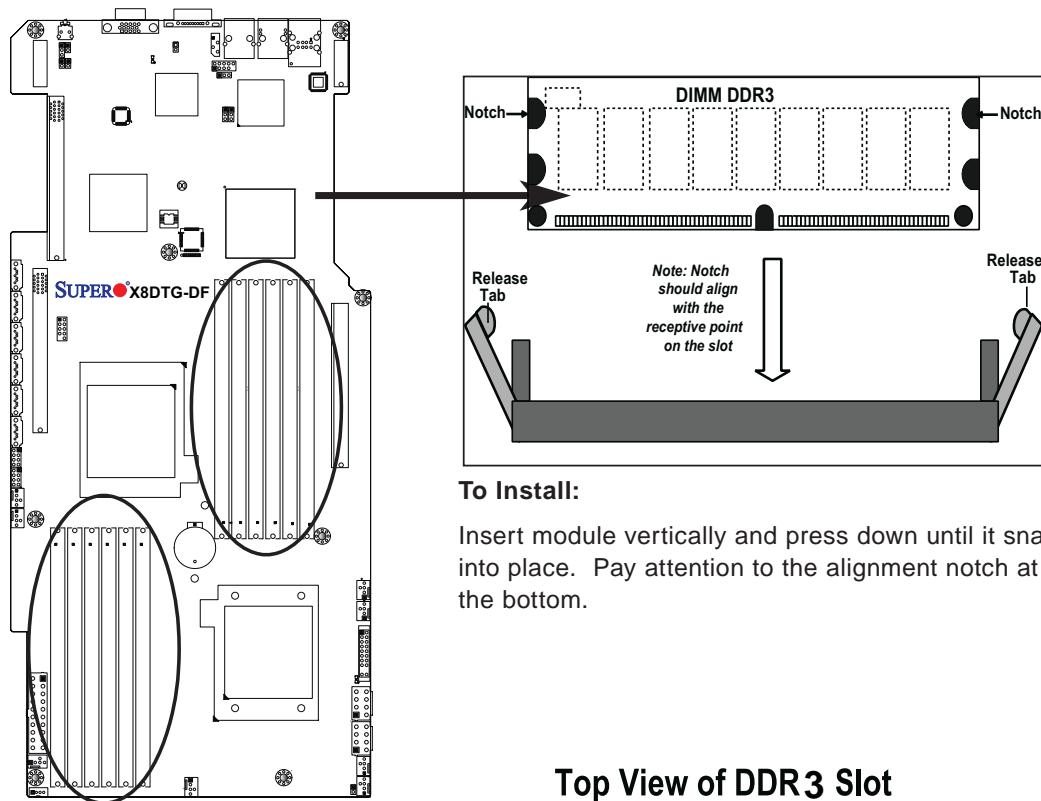

To Install:

Insert module vertically and press down until it snaps into place. Pay attention to the alignment notch at the bottom.

Top View of DDR3 Slot

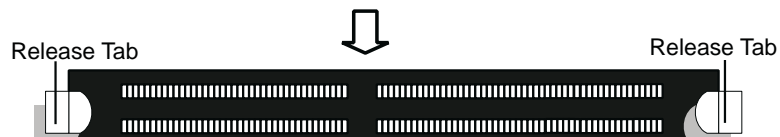

To Remove:

Use your thumbs to gently push the release tabs near both ends of the module. This should release it from the slot.

2-5 Control Panel Connectors/IO Ports

The I/O ports are color coded in conformance with the PC 99 specification. See the picture below for the colors and locations of the various I/O ports.

Back Panel Connectors/IO Ports

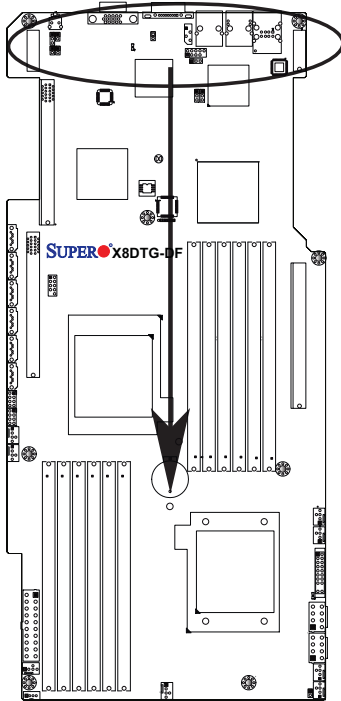

Back Panel Connectors

1. USB 0
2. USB 1
3. IPMI_Dedicated LAN
4. LAN 1
5. LAN 2
6. COM Port 1 (Black)
7. VGA (Blue)
8. UID Switch

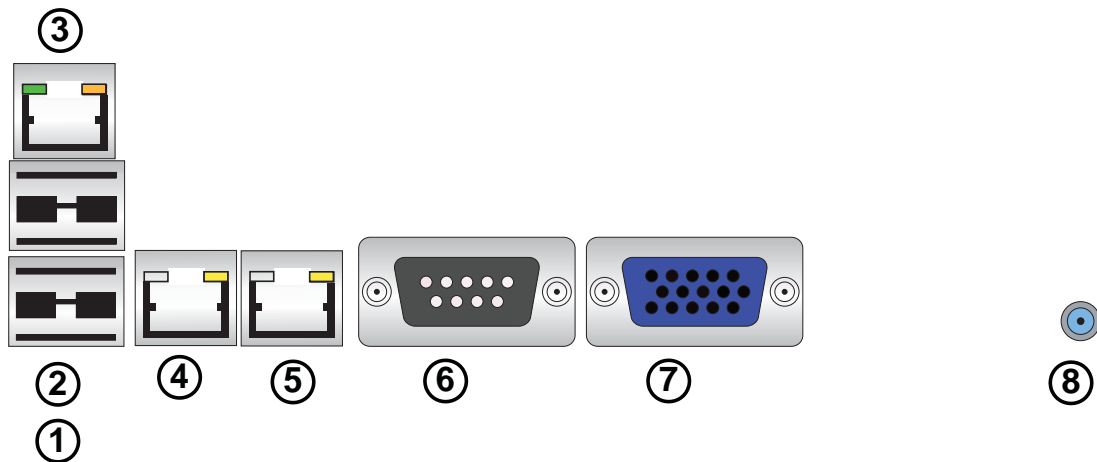

Back Panel Connector Pin Definitions

Universal Serial Bus (USB)

Two Universal Serial Bus ports (USB 0/1) are located on the I/O back panel. Additional two USB connections: USB 2/3 are used to provide front chassis access. Connect USB cables to these USB ports/headers to use USB connections. (USB cables are not included). See the tables on the right for pin definitions.

Back Panel USB 0/1 Pin Definitions			
Pin#	Definition	Pin#	Definition
1	+5V	5	+5V
2	USB_PN1	6	USB_PN0
3	USB_PP1	7	USB_PP0
4	Ground	8	Ground

Front Panel USB 2/3 Pin Definitions			
USB 2		USB 3	
Pin #	Definition	Pin #	Definition
1	+5V	6	+5V
2	USB_PN2	7	USB_PN3
3	USB_PP2	8	USB_PP3
4	Ground	9	Ground
5	No Con- nection	10	Key

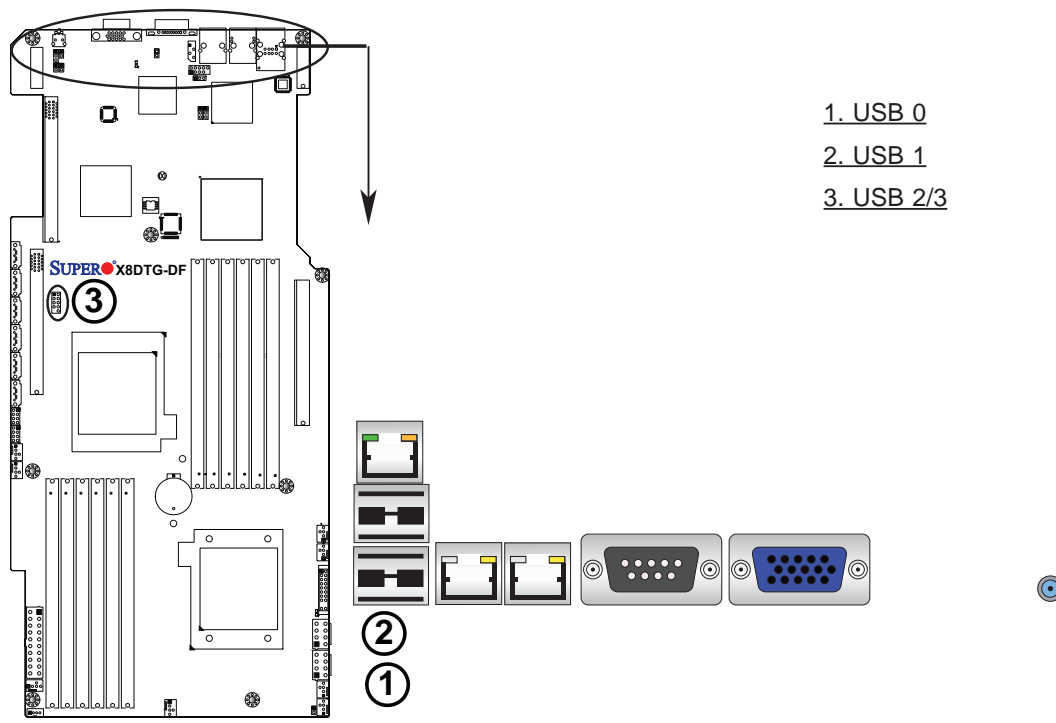

Ethernet Ports

Two Ethernet ports are located next to the USB 0/1 on the IO Backplane. In addition, an IPMI Dedicated LAN is located above the USB ports 0/1. These ports accept RJ45 type cables.



Note:

Please refer to the LED Indicator Section for LAN LED information.

LAN Ports Pin Definition			
Pin#	Definition		
1	P2V5SB	10	SGND
2	TD0+	11	Act LED
3	TD0-	12	P3V3SB
4	TD1+	13	Link 100 LED (Yellow, +3V3SB)
5	TD1-	14	Link 1000 LED (Yellow, +3V3SB)
6	TD2+	15	Ground
7	TD2-	16	Ground
8	TD3+	17	Ground
9	TD3-	88	Ground

(NC: No Connection)

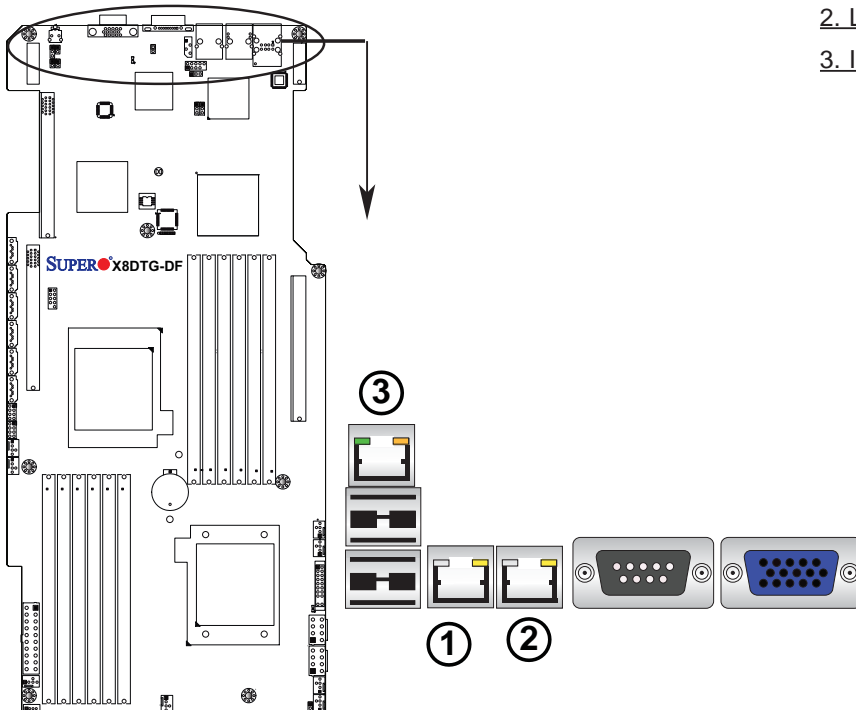

- 1. LAN1
- 2. LAN2
- 3. IPMI dedicated LAN

Serial Ports

A COM Port is located on the IO Backplane. See the table on the right for pin definitions.

Serial Port Pin Definitions (COM1)			
Pin #	Definition	Pin #	Definition
1	CDC	6	DSR
2	RXD	7	RTS
3	TXD	8	CTS
4	DTR	9	RI
5	Ground	10	NC

Video Connector

A Video (VGA) connector is located next to the COM Port on the IO backplane. This connector is used to provide video and CRT display. Refer to the board layout below for the location.

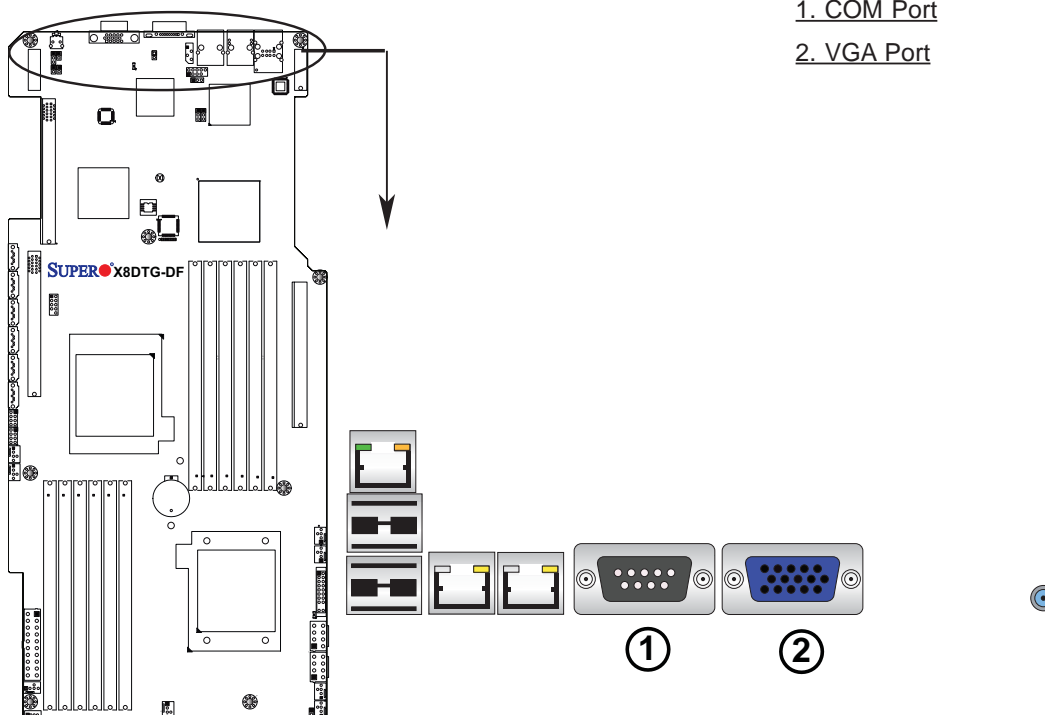

1. COM Port

2. VGA Port

Unit Identifier Switches

Two Unit Identifier (UID) Switches and LED Indicators are located on the motherboard. The Front Panel UID Switch is located at Pin 13 on the Front Control Panel (JF1). The Rear UID Switch is located at SW1 next to the VGA connector on the back panel. The Front Panel UID LED is located at Pin 7 of JF1, and the Rear UID LED is located at LE4. When you press a UID switch on the front panel or on the back panel, both Rear UID LED and Front Panel UID LED Indicators will be turned on. Press the UID switch again to turn off both LED Indicators. These UID Indicators provide easy identification of a system unit that may be in need of service.

UID Switch	
Pin#	Definition
1	Ground
2	Ground
3	Button In
4	Ground

Note: UID LED is supported by the physical switch or the BMC. When it is controlled by the physical switch, it will stay solid. When it is controlled by the BMC, it will blink.

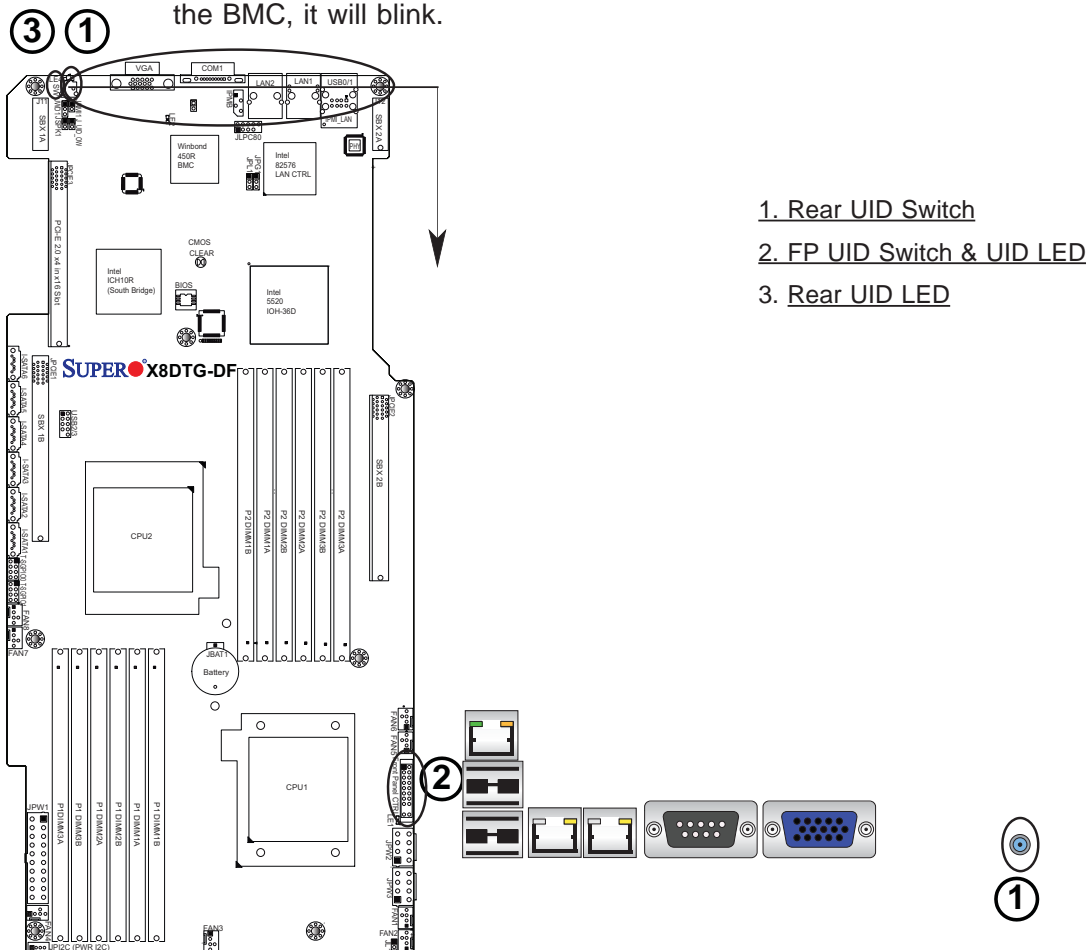

1. Rear UID Switch
2. FP UID Switch & UID LED
3. Rear UID LED

Front Control Panel

JF1 contains header pins for various buttons and indicators that are normally located on a control panel at the front of the chassis. These connectors are designed specifically for use with Supermicro server chassis. See the figure below for the descriptions of the various control panel buttons and LED indicators. Refer to the following section for descriptions and pin definitions.

JF1 Header Pins

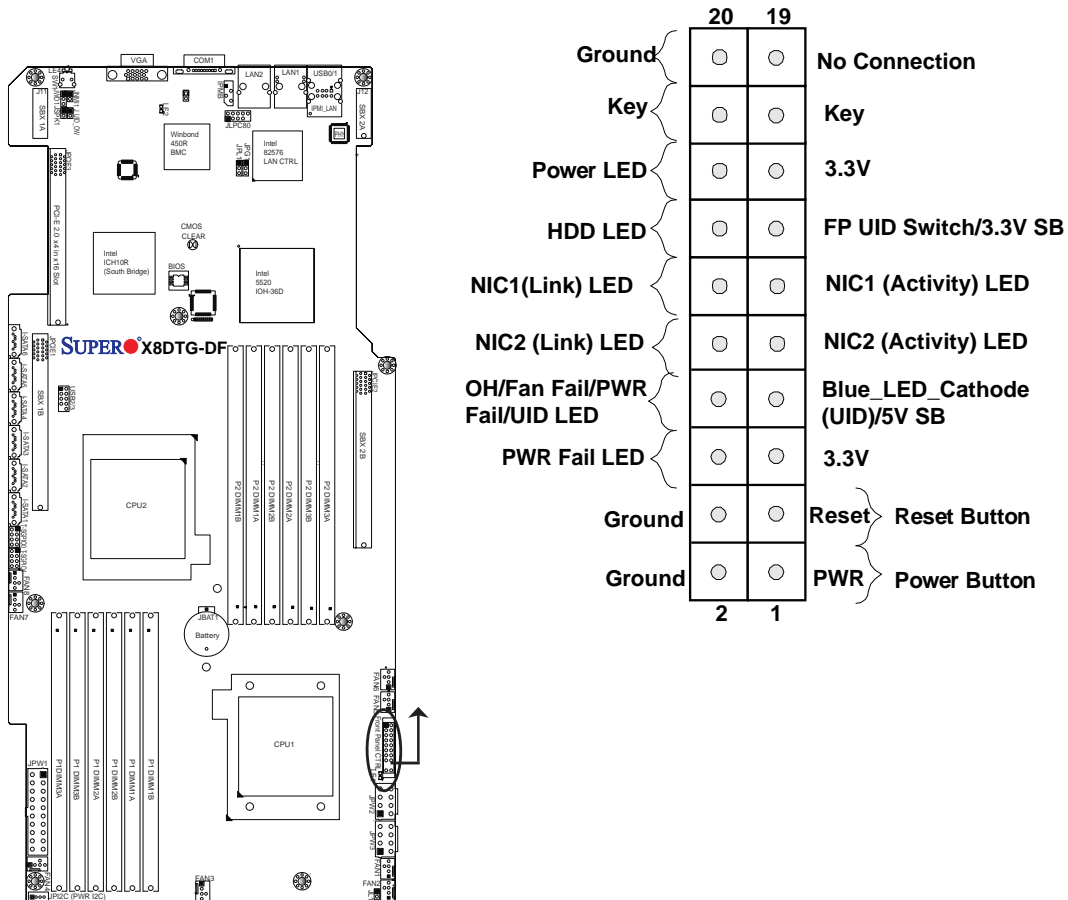

Front Control Panel Pin Definitions

Power LED

The Power LED connection is located on pins 15 and 16 of JF1. Refer to the table on the right for pin definitions.

Power LED Pin Definitions (JF1)	
Pin#	Definition
15	+3.3V SB
16	PWR LED

HDD/FP UID Switch

The HDD/UID Switch connections are located on pins 13/14 of JF1. Attach a hard-drive LED cable to display HDD or SATA activities. This connection can also be used as a front panel UID (Unit Identifier) switch. The UID LED on Pin 7 of JF1 works in conjunction with this UID Switch. When the user presses and releases the UID switch, the UID LED will be turned on or off to indicate the location of the unit. (Refer to Page 2-19 for more details.)

HDD/UID Switch Pin Definitions (JF1)	
Pin#	Definition
13	UID Signal/3.3V
14	HDD Active

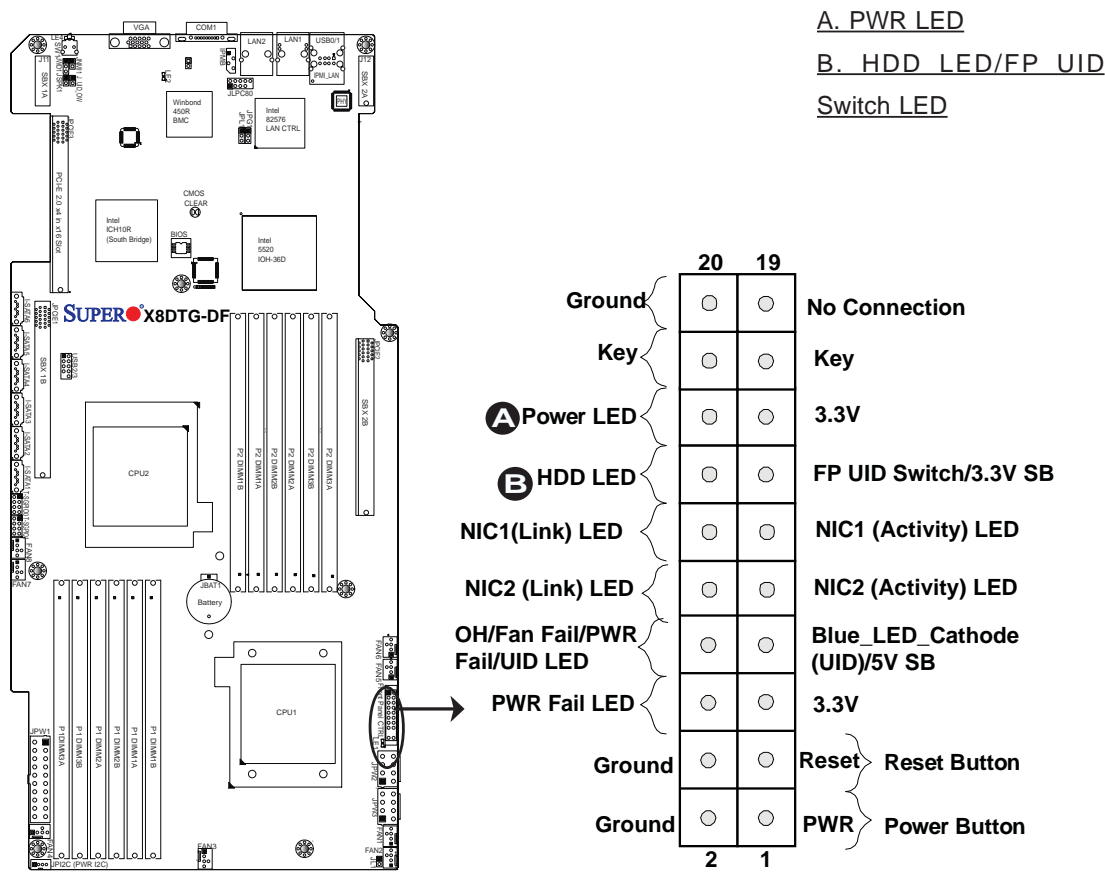

NIC1 LED Indicator

The NIC (Network Interface Controller) LED connections for GLAN port 1 are located on pins 11 and 12 of JF1. Attach a NIC LED cable to display LAN Port1 connections and activities. Refer to the table on the right for pin definitions.

GLAN1 LED Pin Definitions (JF1)	
Pin#	Definition
11	NIC1 Activity
12	NIC1 Link

NIC2 LED Indicator

The Network LED connections for GLAN port 2 are located on pins 9 and 10 of JF1. Attach a NIC LED cable to display LAN Port2 connections and activities. Refer to the table on the right for pin definitions.

GLAN2 LED Pin Definitions (JF1)	
Pin#	Definition
9	NIC2 Activity
10	NIC2 Link

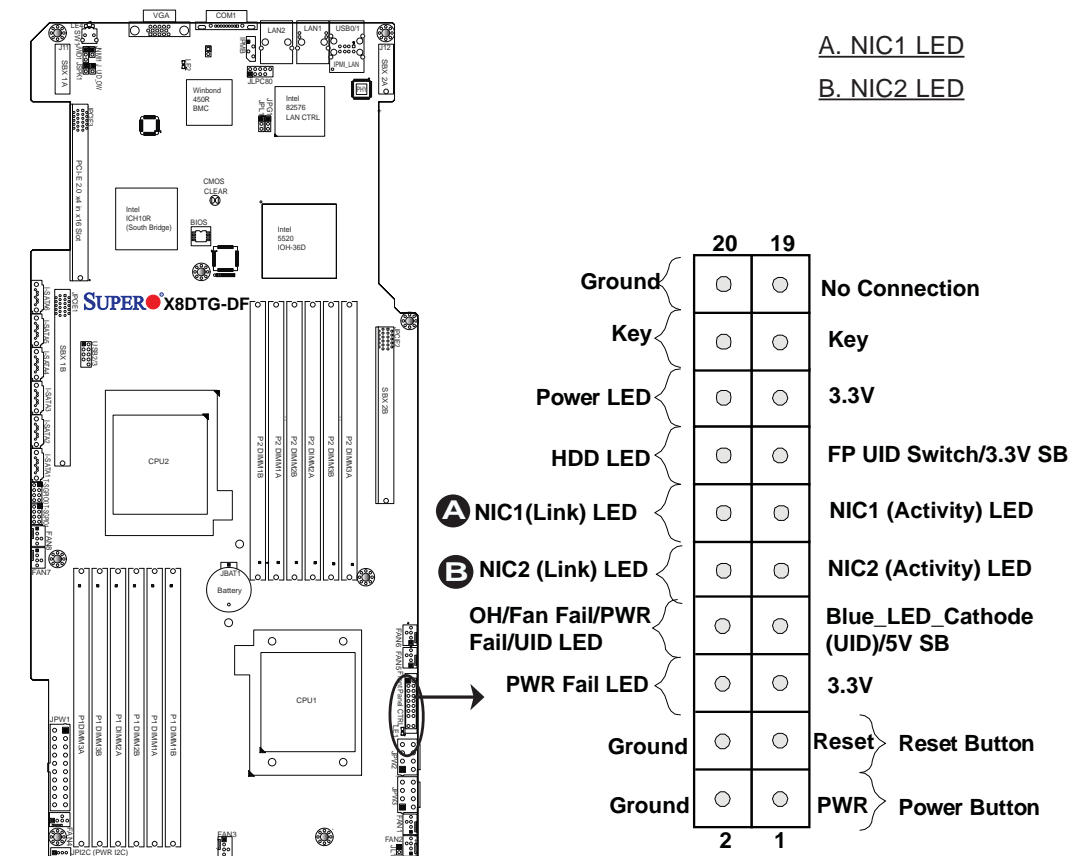

Overheat (OH)/Fan Fail/PWR Fail/UID LED

Connect an LED cable to pins 7 and 8 of JF1 to use the Overheat/Fan Fail/Power Fail and UID LED connections. The Red LED on pin 8 provides warnings of an overheat, fan failure or power failure. The Blue LED on pin 7 works as the UID LED indicator for the front panel UID switch located on pins 13~14 of JF1. When Jumper J_UID_OW is set to off (default), the Red LED takes precedence over the Blue LED. (See Page 2-31 for details.) Refer to the table on the right for pin definitions.

OH/Fan Fail/ PWR Fail/Blue_UID LED Pin Definitions (JF1)	
Pin#	Definition
7	Blue_LED-Cathode(UID)/5.5V.SB
8	OH/Fan Fail/PWR Fail/UID LED (Red)

OH/Fan Fail/PWR Fail LED Status (Red LED)	
State	Definition
Off	Normal
On	Overheat
Flashing	Fan Fail

Power Fail LED

The Power Fail LED connection is located on pins 5 and 6 of JF1. Refer to the table on the right for pin definitions.

PWR Fail LED Pin Definitions (JF1)	
Pin#	Definition
5	3.3V
6	PWR Fail LED

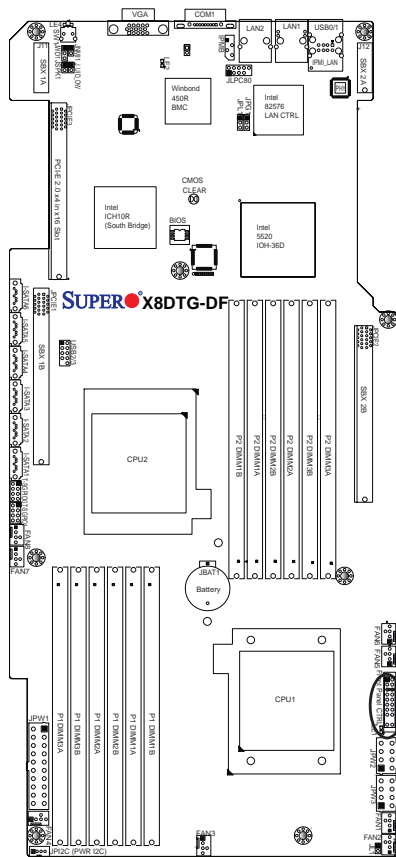

Ground	20	19	No Connection
Key			Key
Power LED			3.3V
HDD LED			FP UID Switch/3.3V SB
NIC1(Link) LED			NIC1 (Activity) LED
NIC2 (Link) LED			NIC2 (Activity) LED
A OH/Fan Fail/PWR Fail/UID LED			Blue_LED_Cathode (UID)/5V SB
B PWR Fail LED			3.3V
Ground			Reset } Reset Button
Ground	2	1	PWR } Power Button

- A. OH/Fan Fail/PWR Fail/UID LED
- B. PWR Supply Fail

Reset Button

The Reset Button connection is located on pins 3 and 4 of JF1. Attach it to a hardware reset switch on the computer case. Refer to the table on the right for pin definitions.

Reset Button Pin Definitions (JF1)	
Pin#	Definition
3	Reset
4	Ground

Power Button

The Power Button connection is located on pins 1 and 2 of JF1. Momentarily contacting both pins will power on/off the system. This button can also be configured to function as a suspend button (with a setting in the BIOS - see Chapter 4). To turn off the power when set to suspend mode, press the button for at least 4 seconds. Refer to the table on the right for pin definitions.

Power Button Pin Definitions (JF1)	
Pin#	Definition
1	PWR
2	Ground

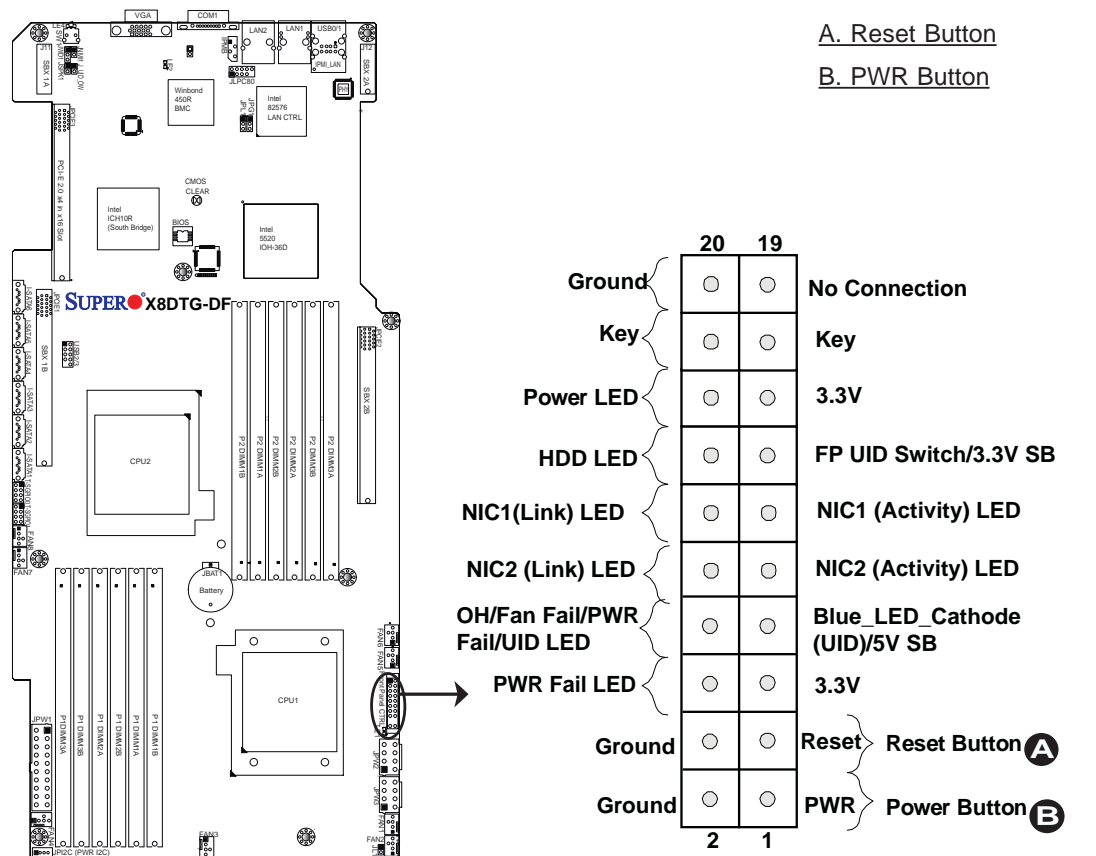

2-6 Connecting Cables

20-pin Proprietary Main Power and 8-pin PCI-E Graphic Card Power Connectors

There are one 20-pin SMC Proprietary main power connector (JPW1) and two 8-pin PCI-Express graphic card power connectors (JPW2/JPW3) on the motherboard. These power connectors meet the SSI EPS 12V specification. See the tables on the right for pin definitions.

 **Notes:** 1. For the these proprietary PWR Connectors to work properly, please customize your PWR cables based on the SMC PWR Connector Pin-Out Definitions listed in the tables on the right.

2. For the PCI-Exp. Graphic cards to work properly, please connect the PCI-E graphic card power connectors (JPW2/JPW3) to the power supply.

20-pin Main Power Connector Pin Definitions			
Pin#	Definition	Pin #	Definition
11	PS On	1	Ground
12	5VSB	2	Ground
13	Ground	3	Ground
14	Ground	4	Ground
15	Ground	5	Ground
16	NC2	6	NC1
17	12V	7	12V
18	12V	8	12V
19	12V	9	12V
20	12V	10	12V

8-pin PCI-E Graphic Card Power Connector Pin Definitions			
Pin#	Definition	Pin #	Definition
1	12V	5	Ground
2	12V	6	Ground
3	12V	7	Ground
4	Ground	8	Ground

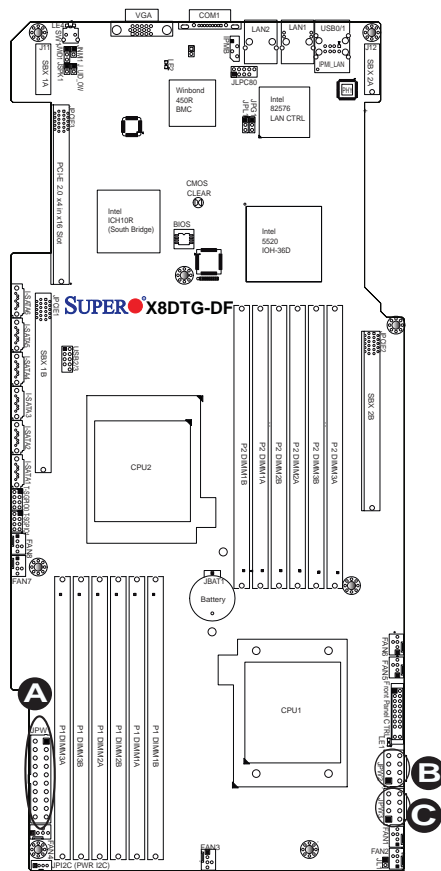

A. 20-pin Main PWR connector (JPW1)
B/C. 8-pin PCI-E Graphic Card PWR connectors (JPW2/JPW3)

Fan Headers

The X8DTG-DF has eight chassis/system fan headers (Fan1 to Fan8) on the motherboard. All these 4-pin fans headers are backward compatible with the traditional 3-pin fans. 3-pin fans do not support fan speed control. However, fan speed control is available for 4-pin fans. The fan speeds are controlled by Thermal Management via Hardware Monitoring in the Advanced Setting in the BIOS. (The Default setting is Disabled.) See the table on the right for pin definitions.

Fan Header Pin Definitions	
Pin#	Definition
1	Ground
2	+12V
3	Tachometer
4	PWR Modulation

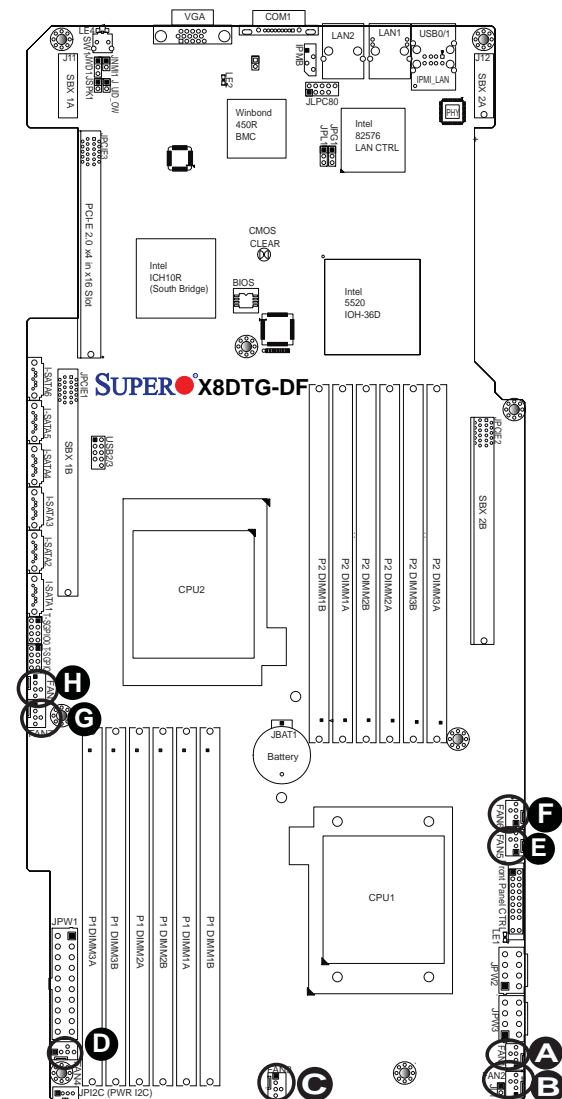

- [A. Fan1](#)
- [B. Fan2](#)
- [C. Fan3](#)
- [D. Fan4](#)
- [E. Fan5](#)
- [F. Fan6](#)
- [G. Fan7](#)
- [H. Fan8](#)

NMI Header

The non-maskable interrupt header is located at JNMI1. Refer to the table on the right for pin definitions.

NMI Button Pin Definitions (JF1)	
Pin#	Definition
1	Control
2	Ground

Internal Buzzer

The Internal Buzzer, located at JSPK1, can be used to provide audible alarms for various beep codes. See the table on the right for pin definitions. Refer to the layout below for the locations of the Internal Speaker/Buzzer.

Internal Buzzer Pin Definitions		
Pin#	Definitions	
Pin 1	Pos. (+)	Beep In
Pin 2	Neg. (-)	Alarm Speaker

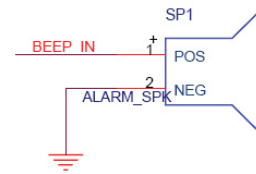

- A. NMI Header
- B. Internal Speaker

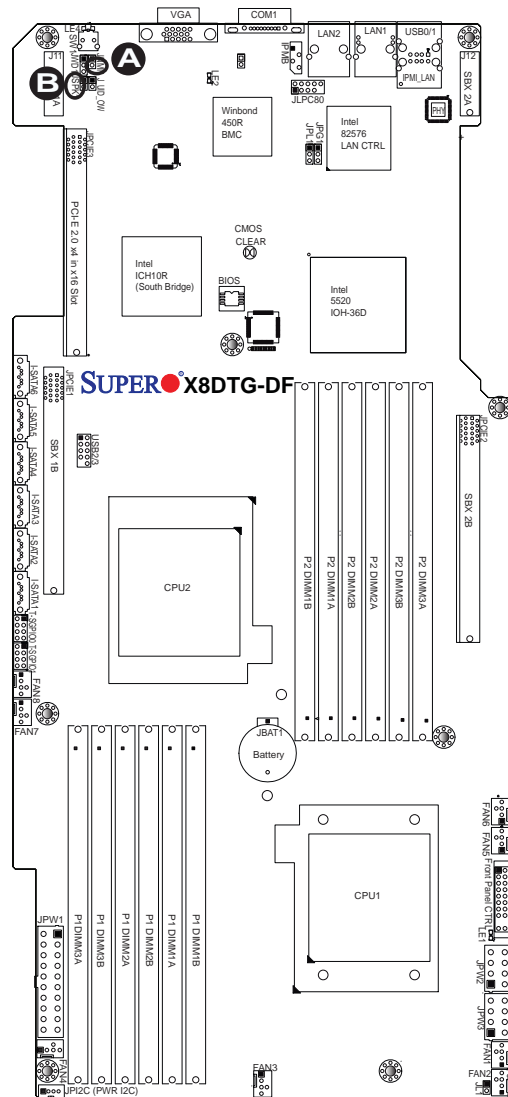

Chassis Intrusion

A Chassis Intrusion header is located at JL1 on the motherboard. Attach an appropriate cable from the chassis to inform you of a chassis intrusion when the chassis is opened.

Chassis Intrusion Pin Definitions (JL1)	
Pin#	Definition
1	Intrusion Input
2	Ground

T-SGPIO Headers

Two SGPIO (Serial-Link General Purpose Input/Output) headers (T-SGPIO-0/T-SGPIO-1) are located on the motherboard. These headers support serial link interfaces for the onboard SATA connectors. See the table on the right for pin definitions. Refer to the board layout below for the location.

T-SGPIO Pin Definitions			
Pin#	Definition	Pin	Definition
1	NC	2	NC
3	Ground	4	Data
5	Load	6	Ground
7	NC	8	NC

Note: NC= No Connections

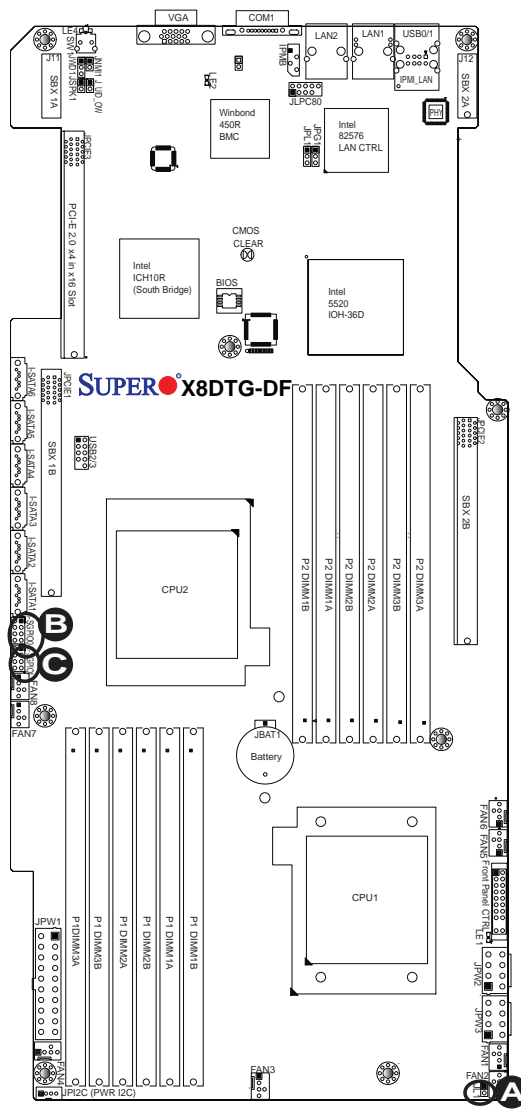

A. Chassis Intrusion

B. T-SGPIO0

C. T-SGPIO1

PWR I²C (SMB) Connector

Power System Management Bus (I²C) Connector (JPI²C) monitors power supply, fan and system temperatures. See the table on the right for pin definitions.

PWR I ² C (SMB) Pin Definitions	
Pin#	Definition
1	Clock
2	Data
3	PWR Fail
4	Ground

IPMB I²C SMB

A System Management Bus (I²C) header for the IPMI slot is located at IPMB. Connect the appropriate cable here to use the IPMB I²C connection on your system.

SMB for IPMI Pin Definitions	
Pin#	Definition
1	Data
2	Ground
3	Clock
4	No Connection

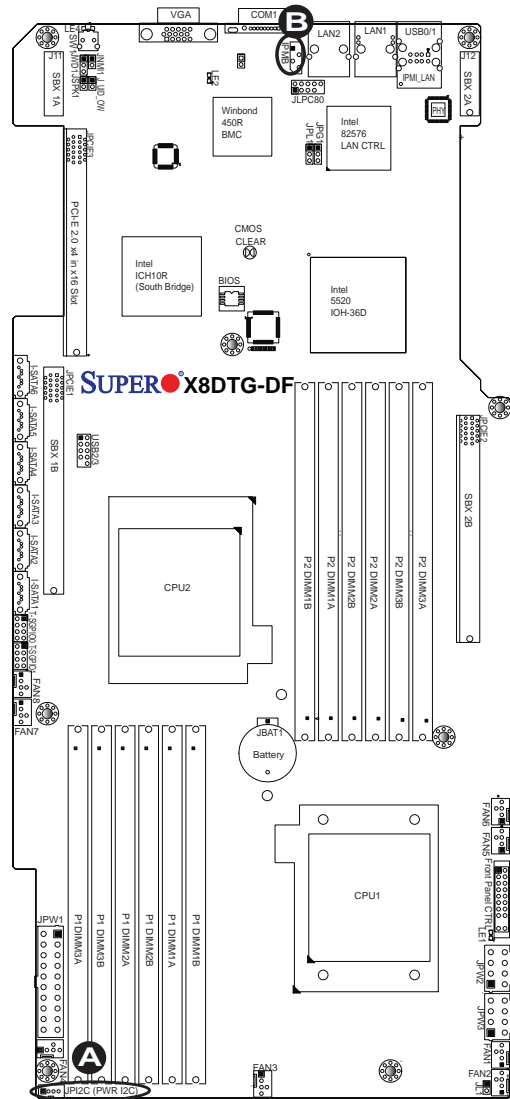

A. PWR I²C (SMB)

B. IPMB SMB

2-7 Jumper Settings

Explanation of Jumpers

To modify the operation of the motherboard, jumpers can be used to choose between optional settings. Jumpers create shorts between two pins to change the function of the connector. Pin 1 is identified with a square solder pad on the printed circuit board. See the motherboard layout pages for jumper locations.

 **Note:** On two pin jumpers, "Closed" means the jumper is on and "Open" means the jumper is off the pins.

GLAN Enable/Disable

JPL1 enables or disables the GLAN Ports 1/2 on the motherboard. See the table on the right for jumper settings.

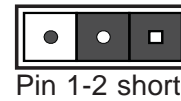
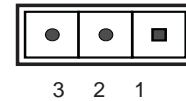
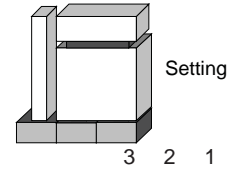
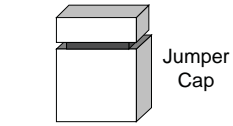
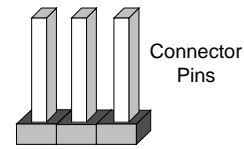

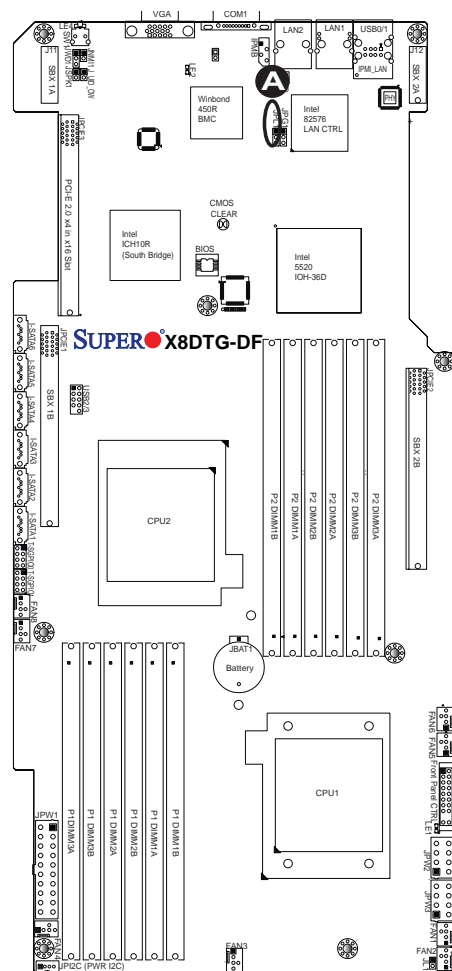

GLAN Enable Jumper Settings	
Pin#	Definition
1-2	Enabled (default)
2-3	Disabled

A. GLAN Port 1/2 Enable



CMOS Clear

JBT1 is used to clear CMOS. Instead of pins, this "jumper" consists of contact pads to prevent the accidental clearing of CMOS. To clear CMOS, use a metal object such as a small screwdriver to touch both pads at the same time to short the connection. Always remove the AC power cord from the system before clearing CMOS. 

 **Note:** For an ATX power supply, you must completely shut down the system, remove the AC power cord and then short JBT1 to clear CMOS.

Watch Dog Enable/Disable

Watch Dog (JWD1) is a system monitor that reboots the system when a software application hangs. Close Pins 1-2 to reset the system if an application hangs. Close Pins 2-3 to generate a non-maskable interrupt signal for the application that hangs. See the table on the right for jumper settings. Watch Dog must also be enabled in the BIOS.

Watch Dog Jumper Settings	
Jumper Setting	Definition
Pins 1-2	Reset (default)
Pins 2-3	NMI
Open	Disabled

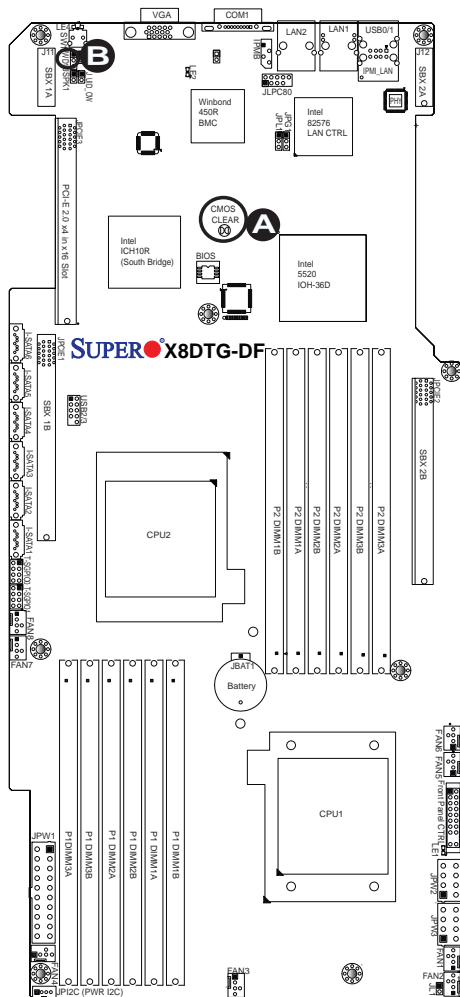

- A. Clear CMOS
- B. Watch Dog Enable

VGA Enable

JPG1 allows you to enable or disable the onboard VGA connection supported by the onboard VGA Controller. The default position is on pins 1 and 2 to enable VGA. See the table on the right for jumper settings.

VGA Enable/Disable Jumper Settings (JPG1)	
Both Jumpers	Definition
Pins 1-2	Enabled
Pins 2-3	Disabled

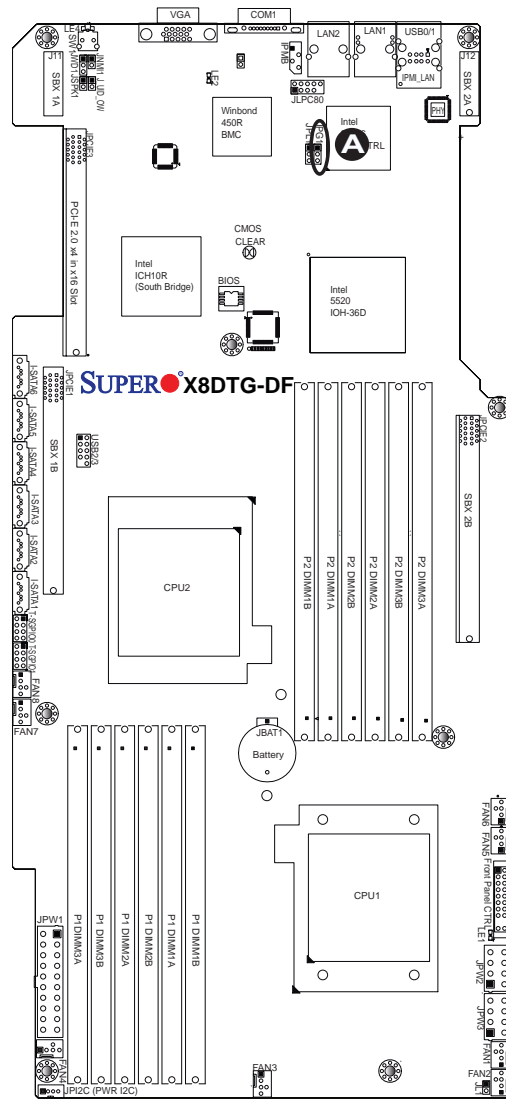

A. VGA Enable

J_UID_OW (-Overwriting)

When the jumper J_UID_OW is set to Off (default), the Red LED (Overheat/Fan Fail/PWR Fail/UID LED) located on Pin 8 of the Front Control Panel (JF1) will take precedence over the Blue UID_LED located on Pin 7 of JF1. In this case, when the Red LED is on, the Blue LED will be turned off. When the RED LED is off, the Blue UID_LED can be on or off. In other words, the Red LED signal overwrites the Blue UID_LED signal if J_UID-OW is set to off. When the jumper J_UID_OW is On, the Red LED (OH/Fan Fail/PWR Fail/UID LED) and the Blue_UID_LED work independently. The Red LED will have no effects on the Blue LED. See the table on the right for jumper settings.

J_UID-OW (-Overwriting) Jumper Settings	
Jumper	Definition
Off (Default)	Red OH/Fan Fail/PWR Fail LED (Pin 8 of JF1) takes precedence over (overwrites) the Blue UID_LED (Pin 7 of JF1). Red LED: On, Blue LED: Off, Red LED: Off, Blue LED: On or Off
On	Red LED (OH/Fan Fail/PWR Fail LED) and the Blue UID_LED function independently. Red LED does not overwrite the Blue LED. The Red LED has no effects on the Blue_UID LED Red LED: On, Blue LED: On,Off Red LED: Off, Blue LED: On, Off

A. J UID LED

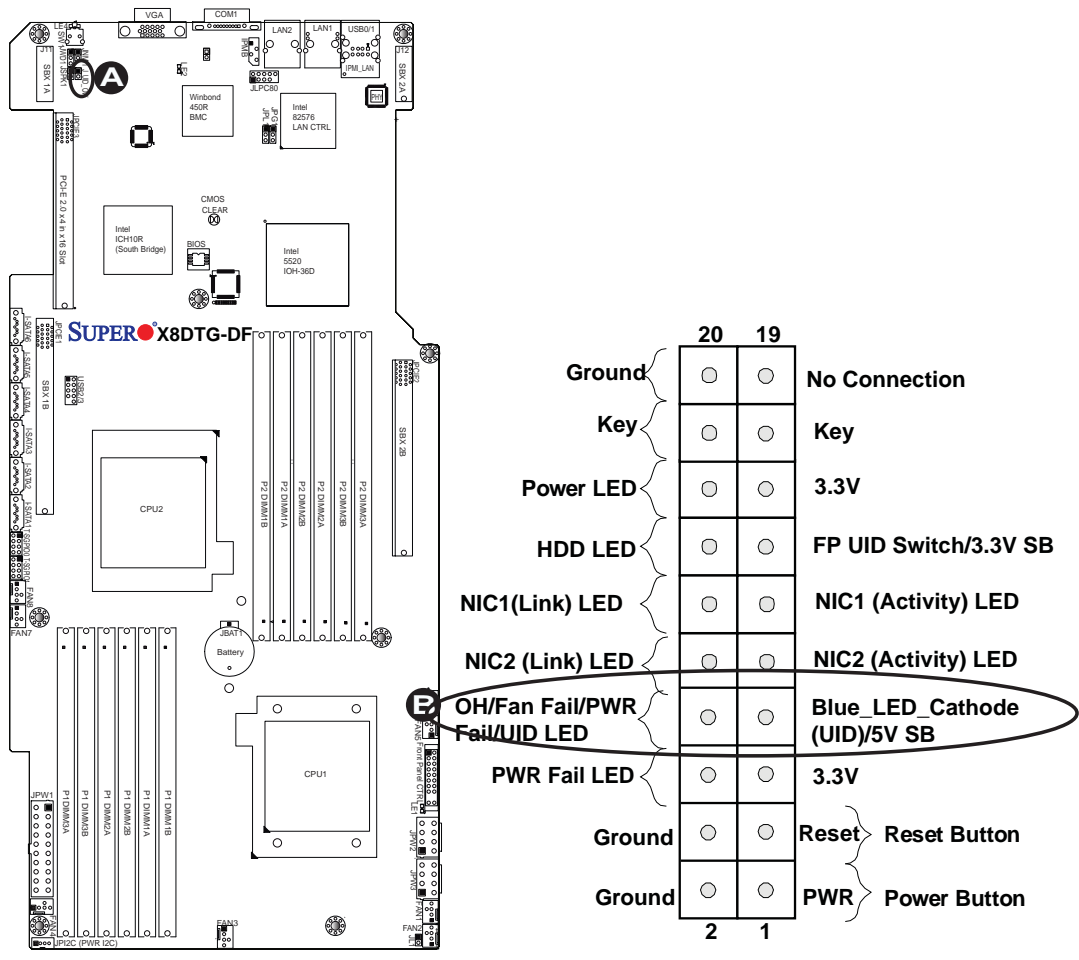

2-8 Onboard Indicators

GLAN LEDs

There are two GLAN ports on the motherboard. An additional IPMI dedicated LAN port is also located above the USB 0/1 ports on the backpanel. Each Gigabit Ethernet LAN port has two LEDs. The yellow LED indicates activity, while the Link LED may be green, amber or off to indicate the speed of the connection. See the tables at right for more information.

 **Note:** IPMI dedicated LAN does not operate at 1 Gbps.

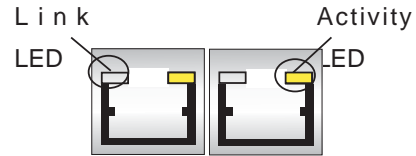

Rear View (when facing the rear side of the chassis)

GLAN Activity Indicator LED Settings		
Color	Status	Definition
Yellow	Flashing	Active

GLAN Link Indicator LED Settings	
LED Color	Definition
Off	No Connection or 10 Mbps
Green	100 Mbps
Amber	1 Gbps

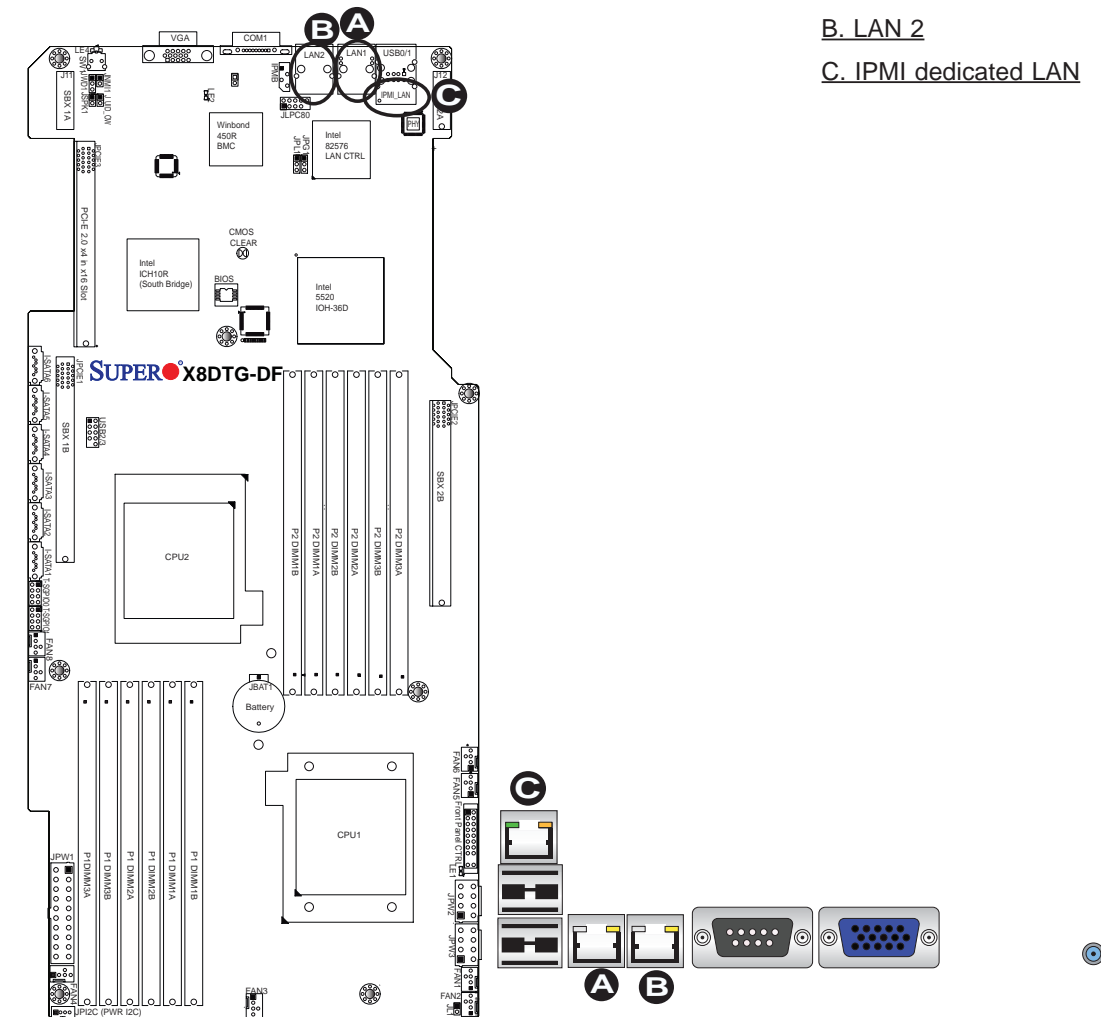

- A. LAN 1
- B. LAN 2
- C. IPMI dedicated LAN

Onboard Power LED

An Onboard Power LED is located at LE1 on the motherboard. When this LED is on, the system power is on. Be sure to turn off the system and unplug the power cord before removing or installing components. See the tables at right for more information.

Onboard PWR LED Indicator Settings	
LED Color	Definition
Off	System Off (PWR cable not connected)
Green	System On
Green: Flashing Quickly	ACPI S1 State

BMC Activity LED

A BMC Heartbeat LED is located at LE2 on the motherboard. When LE2 is on, BMC (Baseboard Management Controller) is active. See the tables at right for more information.

BMC Activity LED Indicator LED Settings	
Green: On	BMC is active

 **Note:** For Rear UID LED (LE4), please refer to Page 2-14.

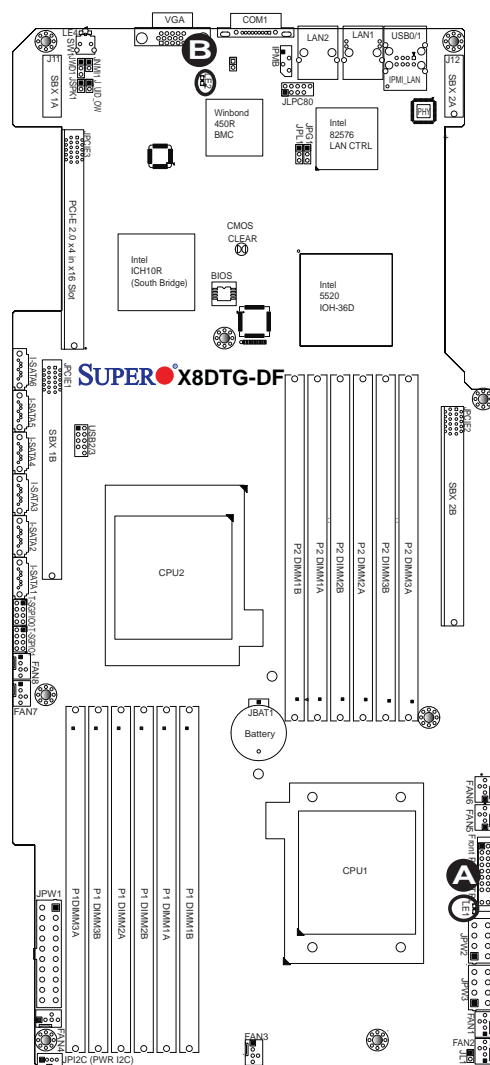

A. LE1

B. LE2

2-9 Serial ATA Connections

Serial ATA Ports

Six Serial ATA Ports (I-SATA1~I-SATA6) are located at JS1~JS6 on the motherboard. These ports provide serial-link signal transmission, which is faster than that of the traditional Parallel ATA. See the table on the right for pin definitions.

Serial ATA Pin Definitions	
Pin#	Definition
1	Ground
2	TX_P
3	TX_N
4	Ground
5	RX_N
6	RX_P
7	Ground

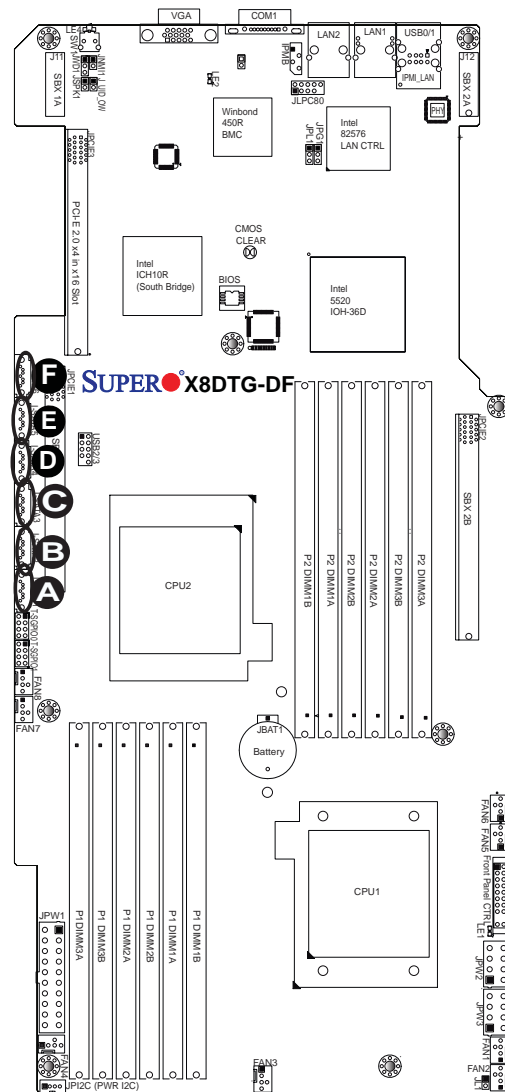

- A. I-SATA1
- B. I-SATA2
- C. I-SATA3
- D. I-SATA4
- E. I-SATA5
- F. I-SATA6

Notes

Chapter 3

Troubleshooting

3-1 Troubleshooting Procedures

Use the following procedures to troubleshoot your system. If you have followed all of the procedures below and still need assistance, refer to the 'Technical Support Procedures' and/or 'Returning Merchandise for Service' section(s) in this chapter. Note: Always disconnect the power cord before adding, changing or installing any hardware components.

Before Power On

1. Make sure that there are no short circuits between the motherboard and chassis.
2. Disconnect all ribbon/wire cables from the motherboard, including those for the keyboard and mouse.
3. Remove all add-on cards.
4. Install CPU 1 first (making sure it is fully seated) and connect the chassis speaker and the power LED to the motherboard. (Check all jumper settings as well.)

No Power

1. Make sure that no short circuits between the motherboard and the chassis.
2. Make sure that all jumpers are set to their default positions.
3. Check that the 115V/230V switch on the power supply is properly set.
4. Turn the power switch on and off to test the system.
5. The battery on your motherboard may be old. Check to verify that it still supplies ~3VDC. If it does not, replace it with a new one.

No Video

1. If the power is on but you have no video, remove all the add-on cards and cables.
2. Use the speaker to determine if any beep codes exist. Refer to the Appendix for details on beep codes.

Losing the System's Setup Configuration

1. Make sure that you are using a high quality power supply. A poor quality power supply may cause the system to lose the CMOS setup information. Refer to Section 1-7 for details on recommended power supplies.
2. The battery on your motherboard may be old. Check to verify that it still supplies ~3VDC. If it does not, replace it with a new one.
3. If the above steps do not fix the Setup Configuration problem, contact your vendor for repairs.

Memory Errors

When a No_Memory_Beep_Code is issued by the system, check the following:

1. Make sure that the DIMM modules are properly and fully installed.
2. Check if different speeds of DIMMs have been installed. It is strongly recommended to use the same RAM speed for all DIMMs in the system.
3. Make sure you are using the correct type of DDR3 Registered ECC or Unbuffered ECC/Non-ECC 1333 MHz/1066 MHz/800 MHz SDRAM (recommended by the manufacturer.)
4. Check for bad DIMM modules or slots by swapping a single module between all memory slots and check the results.
5. Make sure that all memory modules are fully seated in their slots. Make sure to follow the instructions given in Section 2-4 in Chapter 2.
6. Check the position of the 115V/230V switch on the power supply.
7. Please follow the instructions given in the DIMM Population Tables listed on Pages 2-7 and 2-8 to install your memory modules.

3-2 Technical Support Procedures

Before contacting Technical Support, please take the following steps. Also, please note that as a motherboard manufacturer, Supermicro does not sell directly to end-users, so it is best to first check with your distributor or reseller for troubleshooting services. They should know of any possible problem(s) with the specific system configuration that was sold to you.

1. Please go through the 'Troubleshooting Procedures' and 'Frequently Asked Question' (FAQ) sections in this chapter or see the FAQs on our web site (<http://www.supermicro.com/support/faqs/>) before contacting Technical Support.
2. BIOS upgrades can be downloaded from our web site at (<http://www.supermicro.com/support/bios/>).
3. If you still cannot resolve the problem, include the following information when contacting Supermicro for technical support:
 - Motherboard model and PCB revision number
 - BIOS release date/version (this can be seen on the initial display when your system first boots up)
 - System configuration
 - An example of a Technical Support form is on our web site at (<http://www.supermicro.com/support/contact.cfm>).
 - Distributors: For immediate assistance, please have your account number ready when placing a call to our technical support department. We can be reached by e-mail at support@supermicro.com or by fax at: (408) 503-8000, option 2.

3-3 Frequently Asked Questions

Question: What are the various types of memory that my motherboard can support?

Answer: The X8DTG-DF has 12 240-pin DIMM slots that support up to 96 GB of Registered ECC or up to 24 GB of Unbuffered ECC/Non-ECC DDR3 1333/1066/800 MHz Memory. (With Unbuffered ECC/Non-ECC memory, maximum of 2 GB per DIMM is supported.) See Pages 2-7, 2-8 in Chapter 2 for DIMM Slot Population.

Question: How do I update my BIOS?

Answer: It is recommended that you **do not** upgrade your BIOS if you are not experiencing any problems with your system. Updated BIOS files are located on our web site at <http://www.supermicro.com/support/bios/>. Please check our BIOS warning message and the information on how to update your BIOS on our web site. Select your motherboard model and download the BIOS file to your computer. Also, check the current BIOS revision and make sure that it is newer than your BIOS before downloading. You can choose from the zip file and the .exe file. If you choose the zip BIOS file, please unzip the BIOS file onto a bootable USB device. Run the batch file using the format flash.bat filename.rom from your bootable USB device to flash the BIOS. Then, your system will automatically reboot. Please note that this process may take a few minutes to complete. Do not be concerned if the screen is paused for a few minutes.



Warning: Do not shut down or reset the system while updating the BIOS to prevent possible system boot failure!



Note: The SPI BIOS chip used on this motherboard cannot be removed. Send your motherboard back to our RMA Department at Supermicro for repair.

Question: What's on the CD that came with my motherboard?

Answer: The supplied compact disc has quite a few drivers and programs that will greatly enhance your system. We recommend that you review the CD and install the applications you need. Applications on the CD include chipset drivers for the Windows OS, security and audio drivers.

3-4 Returning Merchandise for Service

A receipt or copy of your invoice marked with the date of purchase is required before any warranty service will be rendered. You can obtain service by calling your vendor for a Returned Merchandise Authorization (RMA) number. When returning to the manufacturer, the RMA number should be prominently displayed on the outside of the shipping carton, and mailed prepaid or hand-carried. Shipping and handling charges will be applied for all orders that must be mailed when service is complete. For faster service, You can also request a RMA authorization online (<http://www.supermicro.com/support/rma/>).

This warranty only covers normal consumer use and does not cover damages incurred in shipping or from failure due to the alternation, misuse, abuse or improper maintenance of products.

During the warranty period, contact your distributor first for any product problems.

Chapter 4

BIOS

4-1 Introduction

This chapter describes the AMI BIOS Setup Utility for the X8DTG-DF. The AMI ROM BIOS is stored in a Flash EEPROM and can be easily updated. This chapter describes the basic navigation of the AMI BIOS Setup Utility setup screens.

Starting BIOS Setup Utility

To enter the AMI BIOS Setup Utility screens, press the <Delete> key while the system is booting up.



Note: In most cases, the <Delete> key is used to invoke the AMI BIOS setup screen. There are a few cases when other keys are used, such as <F1>, <F2>, etc.

Each main BIOS menu option is described in this manual. The Main BIOS setup menu screen has two main frames. The left frame displays all the options that can be configured. Grayed-out options cannot be configured. Options in blue can be configured by the user. The right frame displays the key legend. Above the key legend is an area reserved for a text message. When an option is selected in the left frame, it is highlighted in white. Often a text message will accompany it. The AMI BIOS Setup Utility uses a key-based navigation system called "hot keys". Most of the AMI BIOS setup utility "hot keys" can be used at any time during the setup navigation process. These keys include <F1>, <F10>, <Enter>, <ESC>, arrow keys, etc.



Note 1: Options printed in **Bold** are default settings.

Note 2: the AMI BIOS has default text messages built in. Supermicro retains the option to include, omit, or change any of these text messages.)

How To Change the Configuration Data

The configuration data that determines the system parameters may be changed by entering the AMI BIOS Setup utility. This Setup utility can be accessed by pressing at the appropriate time during system boot.

Starting the Setup Utility

Normally, the only visible Power-On Self-Test (POST) routine is the memory test. As the memory is being tested, press the <Delete> key to enter the main menu of the AMI BIOS Setup Utility. From the main menu, you can access the other setup screens. An AMI BIOS identification string is displayed at the left bottom corner of the screen below the copyright message.



Warning! Do not upgrade the BIOS unless your system has a BIOS-related issue. Flashing the wrong BIOS can cause irreparable damage to the system. In no event shall Supermicro be liable for direct, indirect, special, incidental, or consequential damages arising from a BIOS update. If you have to update the BIOS, do not shut down or reset the system while the BIOS is updating. This is to avoid possible boot failure.

4-2 Main Setup

When you first enter the AMI BIOS Setup Utility, you will enter the Main setup screen. You can always return to the Main setup screen by selecting the Main tab on the top of the screen. The Main BIOS Setup screen is shown below.

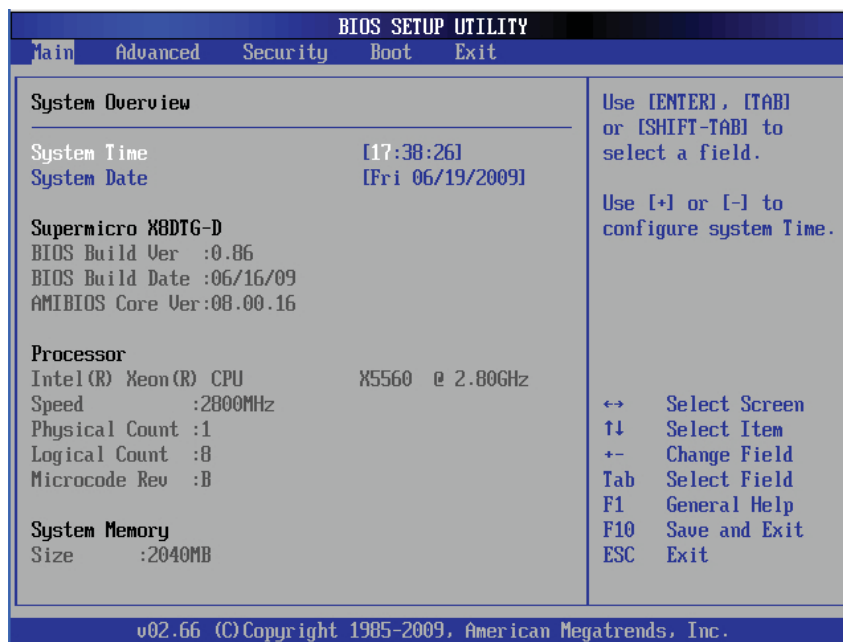

System Overview: The following BIOS information will be displayed:

System Time/System Date

Use this option to change the system time and date. Highlight *System Time* or *System Date* using the arrow keys. Enter new values through the keyboard and press <Enter>. Press the <Tab> key to move between fields. The date must be entered in Day MM/DD/YY format. The time is entered in HH:MM:SS format. (**Note:** The time is in the 24-hour format. For example, 5:30 P.M. appears as 17:30:00.)

Supermicro X8DTG-DF

- BIOS Build Version: This item displays the BIOS revision used in your system.
- BIOS Build Date: This item displays the date when this BIOS was completed.
- AMI BIOS Core Version: This item displays the revision number of the AMI BIOS Core upon which your BIOS was built.

Processor

The AMI BIOS will automatically display the status of the processor used in your system:

- CPU Type: This item displays the type of CPU used in the motherboard.
- Speed: This item displays the speed of the CPU detected by the BIOS.
- Physical Count: This item displays the number of processors installed in your system as detected by the BIOS.
- Logical Count: This item displays the number of CPU Cores installed in your system as detected by the BIOS.
- Microcode Revision: This item displays the revision number of the BIOS Microcode used in your system.

System Memory

This displays the size of memory available in the system:

- Size: This item displays the memory size detected by the BIOS.

4-3 Advanced Setup Configurations

Use the arrow keys to select the Boot Setup submenu, and hit <Enter> to access the following items:

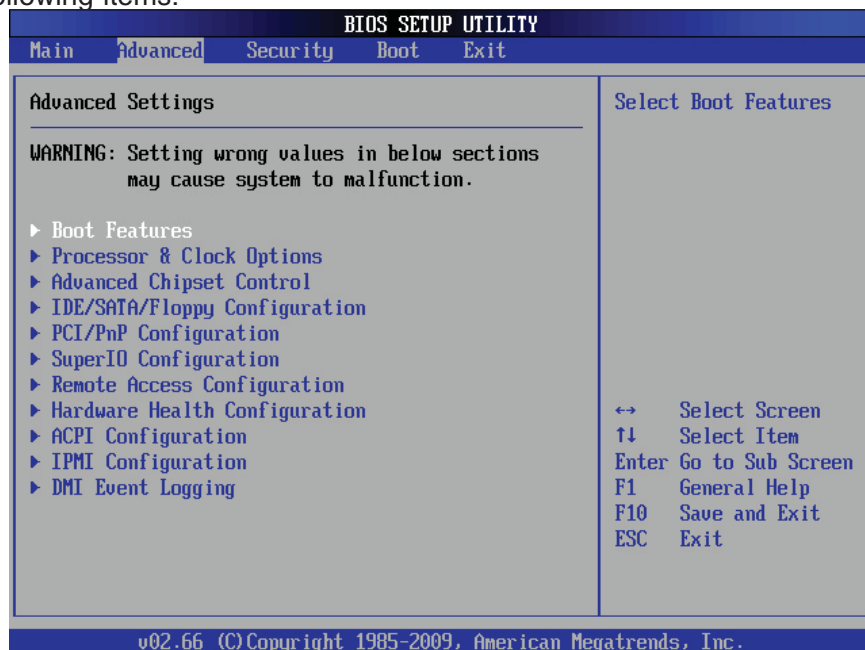

► Boot Features

Quick Boot

If Enabled, this option will skip certain tests during POST to reduce the time needed for system boot. The options are **Enabled** and Disabled.

Quiet Boot

This option allows the bootup screen options to be modified between POST messages or the OEM logo. Select Disabled to display the POST messages. Select Enabled to display the OEM logo instead of the normal POST messages. The options are **Enabled** and Disabled.

AddOn ROM Display Mode

This sets the display mode for the Option ROM. Select Keep Current to use the current AddOn ROM Display setting. Select Force BIOS to use the Option ROM display mode set by the system BIOS. The options are **Force BIOS** and Keep Current.

Bootup Num-Lock

This feature allows the user to select the Power-on state for the Numlock key. The options are Off and **On**.

Wait For 'F1' If Error

This forces the system to wait until the 'F1' key is pressed if an error occurs. The options are Disabled and **Enabled**.

Hit 'Del' Message Display

This feature displays "Press DEL to run Setup" during POST. The options are **Enabled** and Disabled.

Interrupt 19 Capture

Interrupt 19 is the software interrupt that handles the boot disk function. When this item is set to Enabled, the ROM BIOS of the host adaptors will "capture" Interrupt 19 at bootup and allow the drives that are attached to these host adaptors to function as bootable disks. If this item is set to Disabled, the ROM BIOS of the host adaptors will not capture Interrupt 19, and the drives attached to these adaptors will not function as bootable devices. The options are Enabled and **Disabled**.

Power Configuration

Power Button Function

If set to Instant_Off, the system will power off immediately as soon as the user hits the power button. If set to 4_Second_Override, the system will power off when the user presses the power button for 4 seconds or longer. The options are **Instant_Off** and 4_Second_Override.

Restore on AC Power Loss

Use this feature to set the power state after a power outage. Select Power-Off for the system power to remain off after a power loss. Select Power-On for the system power to be turned on after a power loss. Select Last State to allow the system to resume its last state before a power loss. The options are Power-On, Power-Off and **Last State**.

Watch Dog Timer

If enabled, the Watch Dog Timer will allow the system to reboot when it is inactive for more than 5 minutes. The options are Enabled and **Disabled**.

► Processor and Clock Options

This submenu allows the user to configure the Processor and Clock settings.

Ratio CMOS Setting

This option allows the user to set the ratio between the CPU Core Clock and the FSB Frequency. The default setting depends on what type of CPU is installed. For example, the default setting is **[21]**. Press "+" or "-" on your keyboard to change this value.



Note: if an invalid ratio is entered, the AMI BIOS will restore the setting to the previous state.

C1E Support

Select Enabled to use the feature of Enhanced Halt State. C1E significantly reduces the CPU's power consumption by reducing the CPU's clock cycle and voltage during a Halt State. The options are Disabled and **Enabled**.

Hardware Prefetcher (Available when supported by the CPU)

If this item is set to Enabled, the hardware prefetcher will pre fetch streams of data and instructions from the main memory to the L2 cache in the forward or backward manner to improve CPU performance. The options are Disabled and **Enabled**.

Adjacent Cache Line Prefetch (Available when supported by the CPU)

The CPU fetches the cache line for 64 bytes if this option is set to Disabled. The CPU fetches both cache lines for 128 bytes as comprised if **Enabled**.

Intel[®] Virtualization Technology (Available when supported by the CPU)

Select Enabled to use the feature of Virtualization Technology to allow one platform to run multiple operating systems and applications in independent partitions, creating multiple "virtual" systems in one physical computer. The options are **Enabled** and Disabled.



Note: If there is any change to this setting, you will need to power off and restart the system for the change to take effect. Please refer to Intel's web site for detailed information.

Execute-Disable Bit Capability (Available when supported by the OS and the CPU)

Set to Enabled to enable the Execute Disable Bit which will allow the processor to designate areas in the system memory where an application code can execute and where it cannot, thus preventing a worm or a virus from flooding illegal codes to overwhelm the processor or damage the system during an attack. The default is **Enabled**. (Refer to Intel and Microsoft Web Sites for more information.)

Simultaneous Multi-Threading (Available when supported by the CPU)

Set to Enabled to use the Simultaneous Multi-Threading Technology, which will result in increased CPU performance. The options are Disabled and **Enabled**.

Active Processor Cores

Set to Enabled to use a processor's Second Core and beyond. (Please refer to Intel's web site for more information.) The options are **All**, 1 and 2.

Intel[®] EIST Technology

EIST (Enhanced Intel SpeedStep Technology) allows the system to automatically adjust processor voltage and core frequency in an effort to reduce power consump-

tion and heat dissipation. **Please refer to Intel's web site for detailed information.** The options are Disable (Disable GV3) and **Enable (Enable GV3)**.

Intel® TurboMode Technology

Select Enabled to allow the processor cores to run faster than normal under special circumstances to improve performance. The options are Disable and **Enabled**.

Intel® C-State Tech

If enabled, C-State is set by the system automatically to either C2, C3 or C4 state. The options are Disabled and **Enabled**.

C-State package limit setting (Available when Intel® C-State Tech is enabled)

If set to Auto, the AMI BIOS will automatically set the limit on the C-State package register. The options are **Auto**, C1, C3, C6 and C7.

C1 Auto Demotion

When enabled, the CPU will conditionally demote C3, C6 or C7 requests to C1 based on un-core auto-demote information. The options are Disabled and **Enabled**.

C3 Auto Demotion

When enabled, the CPU will conditionally demote C6 or C7 requests to C3 based on un-core auto-demote information. The options are Disabled and **Enabled**.

Clock Spread Spectrum

Select Enable to use the feature of Clock Spectrum, which will allow the BIOS to monitor and attempt to reduce the level of Electromagnetic Interference caused by the components whenever needed. The options are **Disabled** and Enabled.

► Advanced Chipset Control

The items included in the Advanced Settings submenu are listed below:

► CPU Bridge Configuration

QPI Links Speed

This feature selects QPI's data transfer speed. The options are Slow-mode, and **Full Speed**.

QPI Frequency

This selects the desired QPI frequency. The options are **Auto**, 4.800 GT, 5.866GT, 6.400 GT.

QPI L0s and L1

This enables the QPI power state to low power. L0s and L1 are automatically selected by the motherboard. The options are Disabled and **Enabled**.

Memory Frequency

This feature forces a DDR3 frequency slower than what the system has detected to run at the frequency as specified. The available options are **Auto**, Force DDR-800, Force DDR-1066, Force DDR-1333 and Force SPD.

Memory Mode

The options are **Independent**, Channel Mirror, Lockstep and Sparing.

Independent - All DIMMs are available to the operating system.

Channel Mirror - The motherboard maintains two identical copies of all data in memory for redundancy.

Lockstep - The motherboard uses two areas of memory to run the same set of operations in parallel.

Sparing - A preset threshold of correctable errors is used to trigger fail-over. The spare memory is put online and used as active memory in place of the failed memory.

Demand Scrubbing

A memory error-correction scheme where the Processor writes corrected data back into the memory block from where it was read by the Processor. The options are Enabled and **Disabled**.

Patrol Scrubbing

A memory error-correction scheme that works in the background looking for and correcting resident errors. The options are Enabled and **Disabled**.

NUMA Support

Select Enabled to use the feature of Non-Uniform Memory Access to improve CPU performance. The options are **Enabled** and Disabled.

Memory ECC Error Threshold

This feature allows the user to set the correctable memory ECC error limit for AMI BIOS to handle it. The Default setting is 255.

Throttling - Closed Loop/Throttling - Open Loop

Throttling improves reliability and reduces power in the processor by automatic voltage control during processor idle states. Available options are **Disabled** and Enabled. If Enabled, the following items will appear:

Hysteresis Temperature (Closed Loop Only)

Temperature Hysteresis is the temperature lag (in degrees Celsius) after the set DIMM temperature threshold is reached before Closed Loop Throttling begins. The options are Disabled, **1.5°C**, 3.0°C, and 6.0°C.

Guardband Temperature (Closed Loop Only)

Use this feature to change the DIMM temperature threshold. Each step is in 0.5°C increment. The default is **[006]**.

Inlet Temperature

This is the temperature detected at the chassis inlet. Each step is in 0.5°C increment. The default is **[070]**. Press "+" or "-" on your keyboard to change this value.

Temperature Rise

This is the temperature rise to the DIMM thermal zone. Each step is in 0.5°C increment. The default is **[020]**. Press "+" or "-" on your keyboard to change this value.

Air Flow

This is the air flow speed to the DIMM modules. Each step is one mm/sec. The default is **[1500]**. Press "+" or "-" on your keyboard to change this value.

Altitude

This feature defines how many meters above or below sea level the system is located. The options are **Sea Level or Below**, 1~300, 301~600, 601~900, 901~1200, 1201~1500, 1501~1800, 1801~2100, 2101~2400, 2401~2700, 2701~3000.

DIMM Pitch

This is the physical space between each DIMM module. Each step is in 1/1000 of an inch. The default is **[400]**. Press "+" or "-" on your keyboard to change this value.

Serial Debug Message Level

This feature allows the user to set the level of debug message to be displayed. The default setting is **None**.

Margin Ranks

This feature allows the user to set the margin for each rank after configuring Rx DQ, TX DQ, Rx Vref, and Tx Vref settings. The options are Enabled, and **Disabled**.

► North Bridge Configuration

This feature allows the user to configure the settings for the Intel North Bridge chip.

Crystal Beach/DMA (Direct Memory Access)

This feature works in conjunction with the Intel I/O AT (Acceleration Technology) to accelerate the performance of TOE devices. (**Note:** A TOE device is a specialized, dedicated processor that is installed on an add-on card or a network card to handle some or all packet processing of this add-on card.) When this feature is set to Enabled, it will enhance overall system performance by providing direct memory access for data transferring. The options are Enabled and **Disabled**.

Coarse-Grained Clock Gating

Coarse Grained Clock Gating (CGCG) a power-saving technique used on an Intel IO Hub (IOH). When this feature is set to Disabled, all clocks on the die of the IOH chip will be disabled except for the Intel management engine (Intel ME) subsystem. Any non ME clocks left running will detect events to restore clock to the whole die. When this feature is set to Enabled, all clocks on the die will be enabled to maximize power efficiency. The options are **Enabled** and Disabled.

Intel VT-d

Select Enabled to enable Intel's Virtualization Technology support for Direct I/O VT-d by reporting the I/O device assignments to VMM through the DMAR ACPI Tables. This feature offers fully-protected I/O resource-sharing across the Intel platforms, providing the user with greater reliability, security and availability in networking and data-sharing. The settings are Enabled and **Disabled**.

IOH PCIE Port1 Link Select

This feature allows the user to configure the link setting for PCI-Express Port 1 that is connected to the Intel IOH chip. The options are x4x4x4x4, x4x4x8, x8x4x4x, x8x8 and **x16**.

IOH PCIE Max Payload Size

Some add-on cards perform faster with the coalesce feature, which limits the payload size to 128 MB; while others, with a payload size of 256 MB by disabling coalesce support. Please refer to your add-on card user guide for the desired setting. The options are 256 MB and **128MB**.

► South Bridge Configuration

This feature allows the user to configure Intel ICH South Bridge settings.

USB Functions

This feature allows the user to enable onboard USB support. The Options are: Disabled and **Enabled**.

Legacy USB Support

Select Enabled to use Legacy USB devices. Select Auto to automatically enable Legacy USB support if a legacy USB device is installed, and vice versa. Select Disabled to disable Legacy USB support. The options are Disabled, Auto, and **Enabled**.

USB 2.0 Controller

Select Enabled to activate the onboard USB 2.0 controller. The options are **Enabled** and Disabled. (The manufacturer's default setting is Enabled. This setting cannot be changed by the user.)

USB 2.0 Controller Mode

This setting allows you to select the USB 2.0 Controller mode. The options are **Hi-Speed (480 Mbps)** and Full Speed (12 Mbps).

BIOS EHCI Hand-Off

Select Enabled to enable BIOS Enhanced Host Controller Interface support to provide a workaround solution for an operating system that does not have EHCI Hand-Off support. When enabled, the EHCI Interface will be changed from the BIOS-controlled to the OS-controlled. The options are Disabled and **Enabled**.

► IDE/SATA/Floppy Configuration

When this submenu is selected, the AMI BIOS automatically detects the presence of the IDE devices and displays the following items:

SATA#1 Configuration

Select Compatible to set SATA#1 to legacy compatibility mode. Select Enhanced to set SATA#1 to native SATA mode. The options are Disabled, **Compatible** and Enhanced.

Configure SATA#1 as

This feature allows the user to select the drive type for SATA#1. Select RAID (Intel) to enable Intel's SATA RAID firmware to configure Intel's SATA RAID settings. Select RAID (Adaptec) to enable Adaptec's SATA RAID firmware to configure Adaptec's SATA RAID settings. Select AHCI to enable SATA Advanced Host Interface. (Take caution when using this function. This feature is for advanced programmers only.) The options are **IDE**, RAID (Intel), RAID (Adaptec) and AHCI.

SATA#2 Configuration

Select Enhanced to set SATA#2 to native SATA mode. The options are Disabled, and **Enhanced**.

Primary IDE Master/Slave, Secondary IDE Master/Slave, Third IDE Master, and Fourth IDE Master

These settings allow the user to set the parameters of the IDE slots as specified. Hit <Enter> to activate the following submenu items. Set the correct configurations accordingly.

Type

Select the type of device connected to the slot. Select Auto to allow the BIOS to automatically select the device type as it is detected on the slot. Select CD/DVD to configure the slot for CD/DVD devices. Select ARMD to use this slot for removable devices. The options are Not Installed, **Auto**, CD/DVD and ARMD.

LBA/Large Mode

LBA (Logical Block Addressing) is a method of addressing data on a disk drive. In the LBA mode, the maximum drive capacity is 137 GB. For drive capacities over 137 GB, your system must be equipped with a 48-bit LBA mode addressing. If not, contact your manufacturer or install an ATA/133 IDE controller card that supports 48-bit LBA mode. The options are Disabled and **Auto**.

Block (Multi-Sector Transfer)

Block Mode boosts the IDE drive performance by increasing the amount of data transferred. Only 512 bytes of data can be transferred per interrupt if Block Mode is not used. Block Mode allows transfers of up to 64 KB per interrupt. Select Disabled to allow data to be transferred from and to the device one sector at a time. Select Auto to allow data transfer from and to the device occur multiple sectors at a time if the device supports it. The options are **Auto** and Disabled.

PIO Mode

The IDE PIO (Programmable I/O) Mode programs timing cycles between the IDE drive and the programmable IDE controller. As the PIO mode increases, the cycle time decreases. The options are **Auto**, 0, 1, 2, 3, and 4.

Select Auto to allow the AMI BIOS to automatically detect the PIO mode. Use this value if the IDE disk drive support cannot be determined.

Select 0 to allow the AMI BIOS to use PIO mode 0. It has a data transfer rate of 3.3 MBs.

Select 1 to allow the AMI BIOS to use PIO mode 1. It has a data transfer rate of 5.2 MBs.

Select 2 to allow the AMI BIOS to use PIO mode 2. It has a data transfer rate of 8.3 MBs.

Select 3 to allow the AMI BIOS to use PIO mode 3. It has a data transfer rate of 11.1 MBs.

Select 4 to allow the AMI BIOS to use PIO mode 4. It has a data transfer bandwidth of 32-Bits. Select Enabled to enable 32-Bit data transfer.

DMA Mode

Select Auto to allow the BIOS to automatically detect IDE DMA mode when the IDE disk drive support cannot be determined.

Select SWDMA0 to allow the BIOS to use Single Word DMA mode 0. It has a data transfer rate of 2.1 MBs.

Select SWDMA1 to allow the BIOS to use Single Word DMA mode 1. It has a data transfer rate of 4.2 MBs.

Select SWDMA2 to allow the BIOS to use Single Word DMA mode 2. It has a data transfer rate of 8.3 MBs.

Select MWDMA0 to allow the BIOS to use Multi Word DMA mode 0. It has a data transfer rate of 4.2 MBs.

Select MWDMA1 to allow the BIOS to use Multi Word DMA mode 1. It has a data transfer rate of 13.3 MBs.

Select MWDMA2 to allow the BIOS to use Multi-Word DMA mode 2. It has a data transfer rate of 16.6 MBs.

Select UDMA0 to allow the BIOS to use Ultra DMA mode 0. It has a data transfer rate of 16.6 MBs. It has the same transfer rate as PIO mode 4 and Multi Word DMA mode 2.

Select UDMA1 to allow the BIOS to use Ultra DMA mode 1. It has a data transfer rate of 25 MBs.

Select UDMA2 to allow the BIOS to use Ultra DMA mode 2. It has a data transfer rate of 33.3 MBs.

Select UDMA3 to allow the BIOS to use Ultra DMA mode 3. It has a data transfer rate of 66.6 MBs.

Select UDMA4 to allow the BIOS to use Ultra DMA mode 4. It has a data transfer rate of 100 MBs.

Select UDMA5 to allow the BIOS to use Ultra DMA mode 5. It has a data transfer rate of 133 MBs.

Select UDMA6 to allow the BIOS to use Ultra DMA mode 6. It has a data transfer rate of 133 MBs. The options are **Auto**, SWDMAn, MWDMAAn, and UDMAAn.

S.M.A.R.T. For Hard disk drives

Self-Monitoring Analysis and Reporting Technology (SMART) can help predict impending drive failures. Select Auto to allow the AMI BIOS to automatically detect hard disk drive support. Select Disabled to prevent the AMI BIOS from using the S.M.A.R.T. Select Enabled to allow the AMI BIOS to use the S.M.A.R.T. to support hard drive disk. The options are Disabled, Enabled, and **Auto**.

32Bit Data Transfer

Select Enable to enable the function of 32-bit IDE data transfer. The options are **Enabled** and Disabled.

IDE Detect Timeout (sec)

Use this feature to set the time-out value for the BIOS to detect the ATA, ATAPI devices installed in the system. The options are 0 (sec), 5, 10, 15, 20, 25, 30, and **35**.

►PCI/PnP Configuration

Clear NVRAM

This feature clears the NVRAM during system boot. The options are **No** and Yes.

Plug & Play OS

Selecting Yes allows the OS to configure Plug & Play devices. (This is not required for system boot if your system has an OS that supports Plug & Play.) Select **No** to allow the AMI BIOS to configure all devices in the system.

PCI Latency Timer

This feature sets the latency Timer of each PCI device installed on a PCI bus. Select 64 to set the PCI latency to 64 PCI clock cycles. The options are 32, **64**, 96, 128, 160, 192, 224 and 248.

PCI IDE Bus Master

When enabled, the BIOS uses PCI bus mastering for reading/writing to IDE drives. The options are Disabled and **Enabled**.

Load Onboard LAN 1 Option ROM/Load Onboard LAN 2 Option ROM

Select Enabled to enable onboard LAN1/LAN2 Option ROMs support which will allow you to boot your systems using a network interface. The options are Enabled and **Disabled**.

► Super IO Device Configuration

Serial Port1 Address/Serial Port2 Address (-Serial Port2 is used for BMC Serial Over LAN support. It does not have physical Serial Port2 on the MB.)

This option specifies the base I/O port address and the Interrupt Request address of Serial Port 1 and Serial Port 2. Select Disabled to prevent the serial port from accessing any system resources. When this option is set to Disabled, the serial port physically becomes unavailable. Select 3F8/IRQ4 to allow the serial port to use 3F8 as its I/O port address and IRQ 4 for the interrupt address. The options for Serial Port1 are Disabled, **3F8/IRQ4**, 3E8/IRQ4, 2E8/IRQ3. The options for Serial Port2 are Disabled, **2F8/IRQ3**, 3E8/IRQ4, and 2E8/IRQ3.

► Remote Access Configuration

Remote Access

This allows the user to enable Remote Access support. The options are Disabled and **Enabled**. If Remote Access is set to Enabled, the following items will display:

Serial Port Number

This feature allows the user decide which serial port to be used for Console Redirection. The options are **COM 1** and COM2,

Base Address, IRQ

This item displays the base address and IRQ of the serial port used for Console Redirection.

Serial Port Mode

This feature allows the user to set the serial port mode for Console Redirection. The options are **115200 8, n 1**; 57600 8, n, 1; 38400 8, n, 1; 19200 8, n, 1; and 9600 8, n, 1.

Flow Control

This feature allows the user to set the flow control for Console Redirection. The options are **None**, Hardware, and Software.

Redirection After BIOS POST

Select Disabled to turn off Console Redirection after Power-On Self-Test (POST). Select Always to keep Console Redirection active all the time after POST. (Note: This setting may not be supported by some operating systems.) Select Boot Loader to keep Console Redirection active during POST and Boot Loader. The options are Disabled, Boot Loader, and **Always**.

Terminal Type

This feature allows the user to select the target terminal type for Console Redirection. The options are **ANSI**, VT100, and VT-UTF8.

VT-UTF8 Combo Key Support

Select Enabled to enable VT-UTF8 Combination Key support for ANSI/VT100 terminals. The options are **Enabled** and Disabled.

Sredir Memory Display Delay

This feature defines the length of time in seconds to display memory information. The options are **No Delay**, Delay 1 Sec, Delay 2 Sec, and Delay 4 Sec.

► Hardware Health Configuration

This feature allows the user to monitor system health and review the status of each item as displayed.

CPU Overheat Alarm

This option allows the user to select the CPU Overheat Alarm setting which determines when the CPU OH alarm will be activated to provide warning of possible CPU overheat.



Warning!

1. Any temperature that exceeds the CPU threshold temperature predefined by the CPU manufacturer may result in CPU overheat or system instability. When the CPU temperature reaches this predefined threshold, the CPU and system cooling fans will run at full speed.
2. To avoid possible system overheating, please be sure to provide adequate airflow to your system.

The options are:

- **The Early Alarm:** Select this setting if you want the CPU overheat alarm (including the LED and the buzzer) to be triggered as soon as the CPU temperature reaches the CPU overheat threshold as predefined by the CPU manufacturer.
- **The Default Alarm:** Select this setting if you want the CPU overheat alarm (including the LED and the buzzer) to be triggered when the CPU temperature reaches about 5°C above the threshold temperature as predefined by the CPU manufacturer to give the CPU and system fans additional time needed for CPU and system cooling. In both the alarms above, please take immediate action as shown below.

CPU Temperature/System Temperature

This feature displays current temperature readings for the CPU and the System.

The following items will be displayed for your reference only:

CPU 1 Temperature/CPU 2 Temperature

The CPU thermal technology that reports absolute temperatures (Celsius/Fahrenheit) has been upgraded to a more advanced feature by Intel in its newer processors. The basic concept is each CPU is embedded by unique temperature information that the motherboard can read. This 'Temperature Threshold' or 'Temperature Tolerance' has been assigned at the factory and is the baseline on which the motherboard takes action during different CPU temperature conditions (i.e., by increasing CPU Fan speed, triggering the Overheat Alarm, etc). Since CPUs can have different 'Temperature Tolerances', the installed CPU can now send information to the motherboard what its 'Temperature Tolerance' is, and not the other way around. This results in better CPU thermal management.

Supermicro has leveraged this feature by assigning a temperature status to certain thermal conditions in the processor (Low, Medium and High). This makes it easier for the user to understand the CPU's temperature status, rather than by just simply seeing a temperature reading (i.e., 25°C). The CPU Temperature feature will display the CPU temperature status as detected by the BIOS:

Low – This level is considered as the 'normal' operating state. The CPU temperature is well below the CPU 'Temperature Tolerance'. The motherboard fans and CPU will run normally as configured in the BIOS (Fan Speed Control).

User intervention: No action required.

Medium – The processor is running warmer. This is a 'precautionary' level and generally means that there may be factors contributing to this condition, but the CPU is still within its normal operating state and below the CPU 'Temperature Tolerance'. The motherboard fans and CPU will run normally as configured in the BIOS. The fans may adjust to a faster speed depending on the Fan Speed Control settings.

User intervention: No action is required. However, consider checking the CPU fans and the chassis ventilation for blockage.

High – The processor is running hot. This is a 'caution' level since the CPU's 'Temperature Tolerance' has been reached (or has been exceeded) and may activate an overheat alarm.

User intervention: If the system buzzer and Overheat LED has activated, take action immediately by checking the system fans, chassis ventilation and room temperature to correct any problems.



Notes: 1. The system may shut down if it continues for a long period to prevent damage to the CPU.

2. The information provided above is for your reference only. For more information on thermal management, please refer to Intel's Web site at www.Intel.com.

System Temperature: The system temperature will be displayed (in degrees in Celsius and Fahrenheit) as it is detected by the BIOS.

Fan1 ~ Fan 8 Reading

This feature displays the fan speed readings from Fan1 through Fan8. (Fan7 is CPU1 Fan and Fan8 is CPU2 Fan.)

System Fan Monitor

This feature allows the user to decide how the system controls the speeds of the onboard fans. The CPU temperature and the fan speed are correlative. When the CPU on-die temperature increases, the fan speed will also increase, and vice versa. Select Workstation if your system is used as a Workstation. Select Server if your system is used as a Server. Select "Disabled, (Full Speed @12V)" to disable the fan speed control function and allow the onboard fans to constantly run at the full speed (12V). The Options are: **1. Disabled (running @full-speed)**, 2. Server Mode, and 3. Workstation Mode.

Voltage Monitoring

CPU1 Vcore, CPU2 Vcore, +5Vin, 12Vcc (V), V P1 DIMM, V P2 DIMM, 3.3V Vcc (V) and Battery Voltage.

►ACPI Configuration

Use this feature to configure Advanced Configuration and Power Interface (ACPI) power management settings for your system.

ACPI Version Features

The options are **ACPI v1.0**, ACPI v2.0 and ACPI v3.0. Please refer to ACPI's website for further explanation: <http://www.acpi.info/>.

ACPI APIC Support

Select Enabled to include the ACPI APIC Table Pointer in the RSDT (Root System Description Table) pointer list. The options are **Enabled** and Disabled.

APIC ACPI SCI IRQ

When this item is set to Enabled, APIC ACPI SCI IRQ is supported by the system. The options are Enabled and **Disabled**.

Headless Mode

This feature is used to enable system to function without a keyboard, monitor or mouse attached. The options are Enabled and **Disabled**.

High Performance Event Timer

Select Enabled to activate the High Performance Event Timer (HPET) that produces periodic interrupts at a much higher frequency than a Real-time Clock (RTC) does in synchronizing multimedia streams, providing smooth playback and reducing the dependency on other timestamp calculation devices, such as an x86 RDTSC Instruction embedded in the CPU. The High Performance Event Timer is used to replace the 8254 Programmable Interval Timer. The options are Enabled and **Disabled**.

► General WHEA Configuration

WHEA Support

Select Enabled to enable Windows Hardware Error Architecture (WHEA) support which will provide a common infrastructure for handling hardware errors on Windows platforms in order to reduce system crashes due to hardware errors and to improve system recovery and health monitoring. The default setting is **Enabled**.

► IPMI Configuration

Intelligent Platform Management Interface (IPMI) is a set of common interfaces that are used for hardware health monitoring and system management. For more information on the IPMI specifications, please visit Intel's web site at www.intel.com.

Status of BMC

Baseboard Management Controller (BMC) manages the interface between system management software and platform hardware. This is an informational feature which returns the status code of the BMC micro controller.

IPMI Firmware Revision

This item displays the IPMI firmware revision used in your system.

► View BMC System Event Log

This feature displays the BMC System Event Log (SEL). It shows the total number of entries of BMC System Events.

To view an event, select an Entry Number and pressing <Enter> to display the information as shown in the screen.

- SEL Entry Number

- SEL Record ID
- SEL Record Type
- Event
- Timestamp
- Generator ID
- Event Message Format Ver
- Event Sensor Type
- Event Sensor Number,
- Event Dir Type
- Event Data.

Clear BMC System Event Log

Clear BMC System Log

Select OK and press the <Enter> key to clear the BMC system log. Select Cancel to keep the BMC System log. The options are **OK** and Cancel.



Caution: Any cleared information is unrecoverable. Make absolutely sure that you no longer need any data stored in the log before clearing the BMC Event Log.

► Set LAN Configuration

Set this feature to configure the IPMI LAN adapter with a network address as shown in the following graphics.

Channel Number

Enter the channel number for the SET LAN Config command. **Channel Number Status**

This feature returns the channel status for the Channel Number selected above: "Channel Number is OK" or "Wrong Channel Number".

► IP Address Configuration

Parameter Selector

This item displays the parameter of your IP Address configuration.

IP Address Source

Select the source of this machine's IP address. If Static is selected, you will need to know and enter manually the IP address of this machine below. If DHCP is selected, the BIOS will search for a DHCP (Dynamic Host Configuration Protocol) server in the network it is attached to, and request the next available IP address. The options are **DHCP** and Static.

IP Address

This item displays the IP address for the IPMI connection detected.

Current IP Address in BMC

This item displays the current IP address used for your IPMI connection.

► MAC Address Configuration

This submenu displays the following MAC Address Configuration information.

Parameter Selector

Use this feature to select the parameter of your Mac Address configuration.

MAC Address

This item displays the MAC address of this computer used for your IPMI connection.

Current MAC Address in BMC

This item displays the current MAC address used for your IPMI connection.

► Subnet Mask Configuration

Subnet masks tell the network which subnet this machine belongs to. The value of each three-digit number separated by dots should not exceed 255.

Parameter Selector

Use this feature to select the parameter of your Subnet Masks configuration.

Subnet Mask

This item displays the current subnet mask setting for your IPMI connection.

Current Subnet Mask in BMC

This item displays the current subnet mask setting for your IPMI connection.

► Gateway Address Configuration

Enter the gateway address for this machine. This should be in decimal and in dotted quad form (i.e., 192.168.10.253). The value of each three-digit number separated by dots should not exceed 255 as shown in the screen below.

Parameter Selector

Use this feature to select the parameter of your Gateway Address settings.

Gateway Address

The BIOS will automatically enter the Gateway address of this machine; however it may be over-riden. Gateway addresses are 6 two-digit hexadecimal numbers separated by dots.

Current Gateway Address in BMC

This item displays the current Gateway address used for your IPMI connection.

► DMI Event Log

View Event Log

Use this option to view the System Event Log.

Mark all events as read

This option marks all events as read. The options are OK and Cancel.

Clear event log

This option clears the Event Log memory of all messages. The options are OK and Cancel.

4-4 Security Settings

The AMI BIOS provides a Supervisor and a User password. If you use both passwords, the Supervisor password must be set first.



Supervisor Password

This item indicates if a Supervisor password has been entered for the system. "Not Installed" means a Supervisor password has not been used.

User Password

This item indicates if a user password has been entered for the system. "Not Installed" means that a user password has not been used.

Change Supervisor Password

Select this feature and press <Enter> to access the submenu, and then enter a new Supervisor Password.

User Access Level (Available when Supervisor Password is set as above)

Use this feature to set the user's access level. Select **Full Access** to grant the user full read and write access to the Setup Utility. Select **View Only** to allow the user to view the Setup Utility displays without making any changes. Select **Limited** to allow the user to make changes on limited items such as Date and Time, Select **No Access** to prevent the user from entering the Setup Utility.

Change User Password

Select this feature and press <Enter> to enter a new User Password.

Clear User Password (Available only if User Password has been set)

This item allows you to clear a user password after it has been entered.

Password Check

This item allows you to check a password after it has been entered. The options are **Setup** and **Always**.

Boot Sector Virus Protection

When Enabled, the AMI BIOS displays a warning when any program (or virus) issues a Disk Format command or attempts to write to the boot sector of the hard disk drive. The options are Enabled and **Disabled**.

4-5 Boot Configuration

Use this feature to configure boot priority settings.

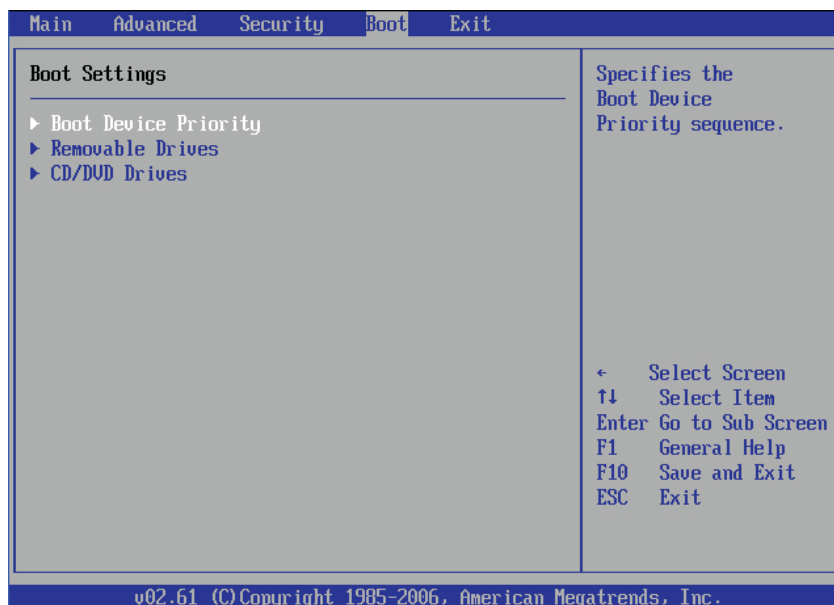

► Boot Device Priority

Use this feature to specify the sequence of boot priority for onboard devices. The settings are 1st boot device~5th boot device and Disabled.

1st Boot Device - 1st Floppy Drive/2nd Boot Device - [USB: XXXXXXXXX]

► Hard Disk Drives

Use this feature to specify the boot sequence from all bootable HDD devices. The settings are Disabled and a list of all hard disk drives that have been detected (i.e., 1st Drive, 2nd Drive, etc).

► Removable Drives

Use this feature to specify the boot sequence from available Removable Drives. The settings are 1st boot device, 2nd boot device, and Disabled.

► CD/DVD Drives

This feature allows the user to specify the boot sequence from available CD/DVD Drives (i.e., 1st Drive, 2nd Drive, etc).

4-6 Exit Options

Select the Exit tab from the AMI BIOS Setup Utility screen to enter the Exit BIOS Setup screen.

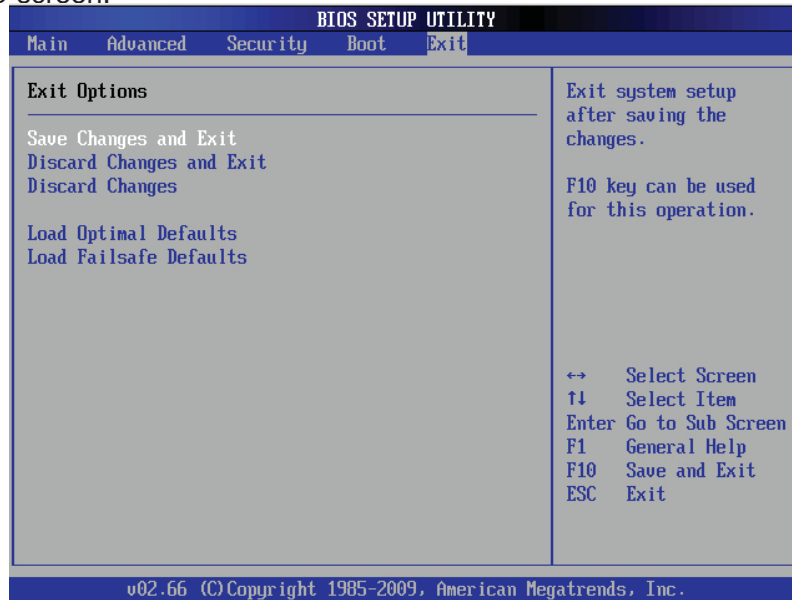

Save Changes and Exit

When you have completed the system configuration changes, select this option to leave the BIOS Setup Utility and reboot the computer, so the new system configuration parameters can take effect. Select Save Changes and Exit from the Exit menu and press <Enter>.

Discard Changes and Exit

Select this option to quit the BIOS Setup without making any permanent changes to the system configuration, and reboot the computer. Select Discard Changes and Exit from the Exit menu and press <Enter>.

Discard Changes

Select this option and press <Enter> to discard all the changes and return to the AMI BIOS Utility Program.

Load Optimal Defaults

To set this feature, select Load Optimal Defaults from the Exit menu and press <Enter>. Then, select OK to allow the AMI BIOS to automatically load Optimal Defaults to the BIOS Settings. The Optimal settings are designed for maximum system performance, but may not work best for all computer applications.

Load Fail-Safe Defaults

To set this feature, select Load Fail-Safe Defaults from the Exit menu and press <Enter>. The Fail-Safe settings are designed for maximum system stability, but not for maximum performance.

4-7 BIOS Recovery



Warning! Do not upgrade the BIOS unless your system has a BIOS-related issue. Flashing the wrong BIOS can cause irreparable damage to the system. In no event shall Supermicro be liable for direct, indirect, special, incidental, or consequential damages arising from a BIOS update. If you need to update the BIOS, do not shut down or reset the system while the BIOS is updating. This is to avoid possible boot failure.

How to Recover the AMIBIOS Image (-the Main BIOS Block)

An AMIBIOS flash chip consists of a boot sector block, and a main BIOS code block (a main BIOS image). The boot sector block contains critical BIOS code, including memory detection and recovery code to be used to flash a new BIOS image if the original BIOS Image is corrupted. When the system is powered on, the boot sector code executes first. Once it is completed, the main BIOS code will continue with system initialization and complete the bootup process.



Notes: BIOS Recovery described below is used when the main BIOS block crashes. However, when the BIOS Boot sector crashes, you will need to send the motherboard back to Supermicro for RMA repairs.

4.7.1 Boot Sector Recovery from a USB Device

This feature allows the user to recover a BIOS image using a USB device without additional utilities needed. A user can download the BIOS image into a USB flash device, and name the file "SUPER.ROM" for the recovery process to load the file. A USB flash device such as a USB Flash Drive, a USB CDROM or a USB CDRW device can be used for this purpose,

1. Insert the USB device that contains the new BIOS image (the ROM files) saved in a root directory into your USB drive.
2. While turning the power on, press and hold <Ctrl> and <Home> at the same time until the USB Access LED Indicator comes on. This might take a few seconds.
3. Once the USB drive LED is on, release the <Ctrl> and <Home> keys. AMIBIOS will issue beep codes to indicate that the BIOS ROM file is being updated.
4. When BIOS flashing is completed, the computer will reboot. Do not interrupt the flashing process until it is completed.

4.7.2 Boot Sector Recovery from an IDE CD-ROM

This process is almost identical to the process of Boot Sector Recovery from a USB device, except that the BIOS image file is loaded from a CD-ROM. Use a CD-R or CD-RW drive to burn a CD with the BIOS image file in it, and name the file "SUPER.ROM" for the recovery process to load the file.

4.7.3 Boot Sector Recovery from a Serial Port ("Serial Flash")

This process, also known as "Serial Flash," allows the user to use a serial port to load a BIOS image for Boot Sector recovery. This feature is usually used for embedded systems that rely on a serial port for remote access and debugging.

Requirements

In order to use Serial Flash for Boot Sector Recovery, you will need to meet the following requirements.

- The "Target system," the system that needs BIOS updates, must have a serial port and "Serial Flash" support embedded in the BIOS image file.
- The "Host system" should also have a serial port and a terminal program that supports XModem Transfer protocol (Hyper Terminal for the Windows operating systems, and minicom for Linux/FreeSBD, etc.).
- A Null_modem serial cable

How to use Serial Flash for Boot Sector Recovery

1. Connect a Null_modem serial cable between the target system and the host system that runs the terminal program.
2. Make sure that the new BIOS Image file is accessible for the host system.
3. Start the terminal program on the host system and create a new connection. Use the following communication parameters for the new connection.
 - Bits per second: 115200 bits/sec.
 - Data Bits: 8
 - Parity: None
 - Stop Bit: 1
 - Flow Control: None

4. Power on your system and click the <Connect> button in the Hyper Terminal. The terminal screen will display the following messages.

```

Press <SpaceBar> to update BIOS.
Confirm update BIOS? (y/n) y
Begin remote BIOS flash? (y/n) y
Starting remote flash.
Upload new BIOS file using Xmodem protocol.
```

5. Following the instructions given on the screen to update the BIOS. These instructions are also shown below.
 - a. At the prompt, press the <SpaceBar> to update the BIOS.
 - b. When asked to confirm BIOS updating, press <y> to confirm BIOS updates.
 - c. Press <y> again to begin flashing BIOS remotely.

 **Note:** Be sure to complete Steps a~c above quickly because you have a second or less to do so.

6. Once you've completed the instructions given, a screen will display to indicate that remote flashing is starting and the new BIOS file is being uploaded.
7. To use Hyper Terminal to transfer the XModem protocol by using the "Send File" dialog under the "Transfer" menu, follow the instructions below to complete XModem transfers.

- a. Select the "Transfer" menu and enter <Send>.

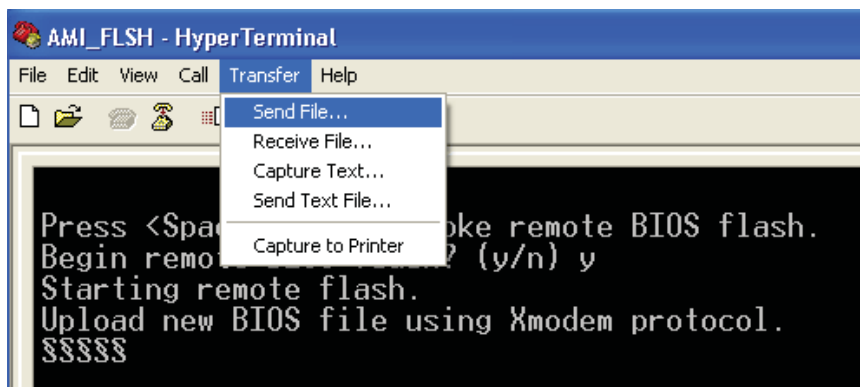

- b. Specify the location of the ROM file and select the proper protocol (XModem).
- c. Press <Send> to start ROM File extraction. (See the picture below.)

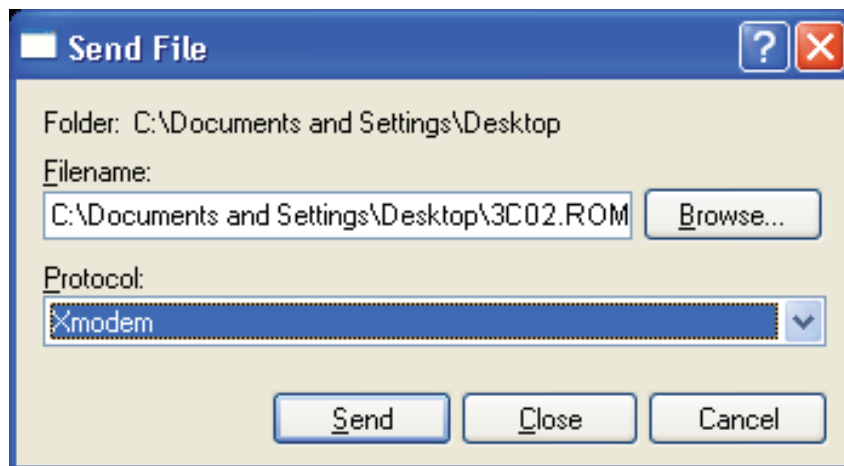

- d. Once the ROM file extraction is completed, the message: "New BIOS received OK" will display.

```
Starting FLASH Recovery.  
NVRAM data will be destroyed.  
CMOS data will be preserved.  
.....  
Ending FLASH Recovery.  
FLASH Update completed successfully.  
Rebooting...
```

8. Once remote BIOS flash is completed, the system will reboot.

 **Note:** AMIBIOS Serial Flash will work with any terminal communications program that supports VT-100 and XModem protocols, including protocols designed for GNU/LINUX & BSD operating systems such as minicom. It is recommended that the terminal program be configured to use the 'CR/LF' style of line termination.

Notes

Appendix A

BIOS Error Beep Codes

During the POST (Power-On Self-Test) routines, which are performed each time the system is powered on, errors may occur.

Non-fatal errors are those which, in most cases, allow the system to continue the boot-up process. The error messages normally appear on the screen.

Fatal errors are those which will not allow the system to continue the boot-up procedure. If a fatal error occurs, you should consult with your system manufacturer for possible repairs.

A-1 BIOS Error Beep Codes

BIOS Error Beep Codes		
Beep Code	Error Message	Description
1 beep	Refresh	Circuits have been reset. (Ready to power up)
5 short beeps + 1 long beep	Memory error	No memory detected in the system
8 beeps	Display memory read/write error	Video adapter missing or with faulty memory
1 continuous beep (with the front panel OH LED on)	System Overheat	1 continuous beep with the front panel OH LED on

Notes

Appendix B

Installing the Windows OS

After all hardware components have been installed, you must first configure Intel South Bridge RAID Settings before you install the Windows OS and other software drivers. To configure RAID settings, please refer to RAID Configuration User Guides posted on our web site at www.supermicro.com/support/manuals.



Note: The following OS installation instructions are written for the Windows XP/2003 OS only. If you have the Windows 2008 or Windows Vista OS, please follow the instructions displayed on your screen to install the OS.

B-1 Installing the Windows OS for a RAID System

1. Insert Microsoft's Windows XP/Windows 2003 Setup CD in the CD Drive, and the system will start booting up from CD.
2. Press the <F6> key when the message-" Press F6 if you need to install a third party SCSI or RAID driver" displays.
3. When the Windows XP/Windows 2003 Setup screen appears, press "S" to specify additional device(s).
4. Insert the driver diskette-"Intel AA RAID XP/2003 Driver for ICH10R" into Drive A: and press the <Enter> key.
5. Choose the Intel(R) ICH10R *SATA RAID Controller* from the list indicated in the XP/2003 Setup Screen, and press the <Enter> key.
6. Press the <Enter> key to continue the installation process. (If you need to specify any additional devices to be installed, do it at this time.) Once all devices are specified, press the <Enter> key to continue with the installation.
7. From the Windows XP/Windows 2003 Setup screen, press the <Enter> key. The XP/2003 Setup will automatically load all device files and then, continue the Windows XP/Windows 2003 installation.
8. After the Windows XP/Windows 2003 OS Installation is completed, the system will automatically reboot.

B-2 Installing the Windows OS for a Non-RAID System

1. Insert Microsoft's Windows OS Setup CD in the CD Driver, and the system will start booting up from CD.
2. Continue with the OS installation. The Windows OS Setup screen will display.
3. From the Windows OS Setup screen, press the <Enter> key. The OS Setup will automatically load all device files and then continue with the Windows OS installation.
4. After the Windows OS Installation is completed, the system will automatically reboot.
5. Insert the Supermicro Setup CD that came with your motherboard into the CD Drive during system boot, and the main screen will display.

Appendix C

Software Installation Instructions

C-1 Installing Software Programs

After you have installed the Windows Operating System, a screen as shown below will appear. You are ready to install software programs and drivers that have not yet been installed. To install these software programs and drivers, click the icons to the right of these items.



Driver/Tool Installation Display Screen



Notes:

1. Click the icons showing a hand writing on the paper to view the readme files for each item. Click on a computer icon to the right of an item to install an item (from top to the bottom) one at a time. After installing each item, you must reboot the system before proceeding with the next item on the list. The bottom icon with a CD on it allows you to view the entire contents of the CD.
2. When making a storage driver diskette from booting into a Driver CD, please set the SATA Configuration to "Compatible Mode" and configure SATA as IDE in the BIOS Setup. After making the driver diskette, be sure to change the SATA settings back to your original settings.

C-2 Configuring Supero Doctor III

The Supero Doctor III program is a Web-base management tool that supports remote management capability. It includes Remote and Local Management tools. The local management is called the SD III Client. The Supero Doctor III program included on the CDROM that came with your motherboard allows you to monitor the environment and operations of your system. Supero Doctor III displays crucial system information such as CPU temperature, system voltages and fan status. See the Figure below for a display of the Supero Doctor III interface.

 **Note:** 1 The default user name and password are ADMIN.

Note 2: In the Windows OS environment, the Supero Doctor III settings take precedence over the BIOS settings. When first installed, Supero Doctor III adopts the temperature threshold settings previously set in BIOS. Any subsequent changes to these thresholds must be made within Supero Doctor, since the SD III settings override the BIOS settings. For the Windows OS to adopt the BIOS temperature threshold settings, please change the SDIII settings to be the same as those set in BIOS.

Supero Doctor III Interface Display Screen-I (Health Information)



Supero Doctor III Interface Display Screen-II (Remote Control)



 **Note:** SD III Software Revision 1.0 can be downloaded from our Web site at: ftp://ftp.supermicro.com/utility/Supero_Doctor_III/. You can also download SDIII User's Guide at: <http://www.supermicro.com/PRODUCT/Manuals/SDIII/UserGuide.pdf>. For Linux, we will still recommend that you use Supero Doctor II.

Notes

(Disclaimer Continued)

The products sold by Supermicro are not intended for and will not be used in life support systems, medical equipment, nuclear facilities or systems, aircraft, aircraft devices, aircraft/emergency communication devices or other critical systems whose failure to perform be reasonably expected to result in significant injury or loss of life or catastrophic property damage. Accordingly, Supermicro disclaims any and all liability, and should buyer use or sell such products for use in such ultra-hazardous applications, it does so entirely at its own risk. Furthermore, buyer agrees to fully indemnify, defend and hold Supermicro harmless for and against any and all claims, demands, actions, litigation, and proceedings of any kind arising out of or related to such ultra-hazardous use or sale.

Free Manuals Download Website

<http://myh66.com>

<http://usermanuals.us>

<http://www.somanuals.com>

<http://www.4manuals.cc>

<http://www.manual-lib.com>

<http://www.404manual.com>

<http://www.luxmanual.com>

<http://aubethermostatmanual.com>

Golf course search by state

<http://golfingnear.com>

Email search by domain

<http://emailbydomain.com>

Auto manuals search

<http://auto.somanuals.com>

TV manuals search

<http://tv.somanuals.com>