



## 27" Integrated Combination—Tall

Integrated refrigeration can be used anywhere in the home. It merges seamlessly into the décor, with no visible hinges or grilles. Model 700TCI has an upper cabinet refrigerator with freezer storage drawers. Two distinct temperature zones ensure the freshest food and energy efficiency. This model is ENERGY STAR® qualified for energy efficiency.



### FEATURES

- Upper cabinet refrigerator and two freezer storage drawers.
- Custom front panels and hardware allow for infinite design options.
- Point-of-use refrigeration that can be placed anywhere in the home.
- Dual refrigeration system ensures the freshest food and energy efficiency.
- Microprocessor maintains precise control, within 1° of set temperature.
- Easy-access, illuminated touch control panel.
- Bright interior lighting in cabinet and drawers.
- Adjustable spill-proof glass shelves, door shelves and dairy compartment.
- Adjustable deli drawer with shelf for storage of smaller items.
- Smooth-glide, full-extension storage drawers.
- Alarm feature will sound an audible beep if door or drawer is left open.
- Automatic ice maker provides crescent-shaped ice.
- 90° door stop built into hinge.
- Star-K compliant with harness kit.
- Meets U.S. Department of Energy standards.

### MODEL

700TCI

Design

Integrated

### INTERIOR FEATURES

- **Refrigerator**
  - Dual Refrigeration
  - 2 Temperature Zones
  - 3 Adjustable Glass Shelves
  - 1 Stationary Shelf
  - Adjustable Deli Drawer
  - 3 Adjustable Door Shelves
  - Adjustable Dairy Compartment
  - Egg Container
- **Freezer (Drawers)**
  - 1 Removable Drawer Divider
  - Automatic Defrost
  - Automatic Ice Maker

### ACCESSORIES

- Stainless steel front panels with tubular or pro handles—80" or 84" finished height.
- Stainless steel tubular and pro handles.
- Dual installation kit for installation with column, tall or drawer model.
- Crisper drawer and shelf assembly.
- Dozen egg container.

*Accessories are available through your Sub-Zero dealer. For local dealer information, visit the find a showroom section of our website, subzero.com.*





## 27" Integrated Combination—Tall

### OVERALL DIMENSIONS

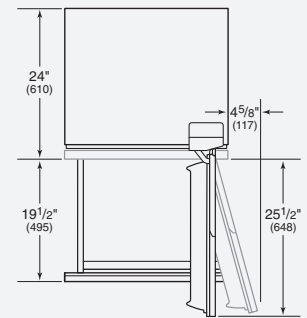
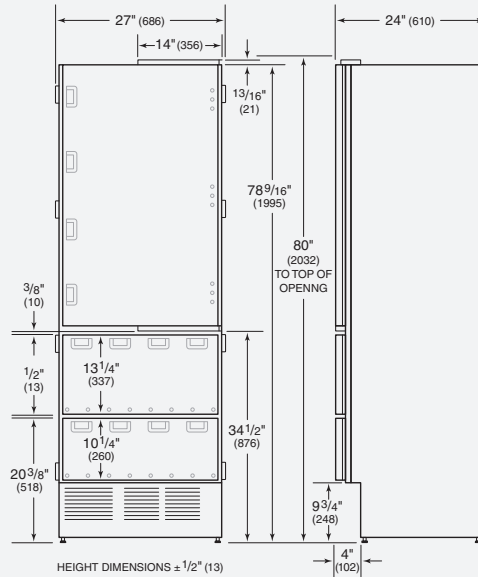

DIMENSIONS WILL VARY WITH PANEL THICKNESS

Unit dimensions may vary by  $\pm 1/8$ ".

### SPECIFICATIONS

Overall Width	27"
Overall Height	80"
Overall Depth	24"
Door Clearance	25 1/2"
Drawer Clearance	19 1/2"
Refrigerator Capacity	10.2 cu ft
Freezer Capacity	5.1 cu ft
Finished Opening	27" W x 80" H x 25" D*
Electrical Requirements	115 V AC, 60 Hz 15 amp dedicated circuit
Plumbing Requirements	1/4" OD copper, braided stainless steel or PEX tubing 35–120 psi
Shipping Weight	360 lbs

\*Depth is 24" from the front of the unit to its back. Your design may necessitate moving the unit back, or cabinets forward to achieve a flush fit. This will require a minimum opening depth of 25".

### INSTALLATION SPECIFICATIONS

#### Opening Dimensions

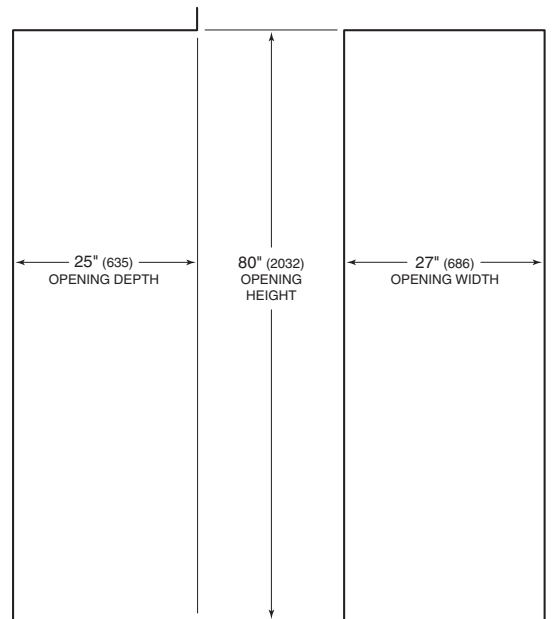

SIDE VIEW

FRONT VIEW

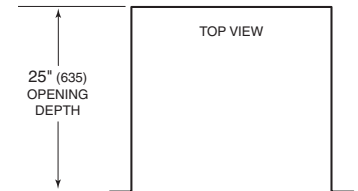

Dimensions in parentheses are in millimeters unless otherwise specified.

### INSTALLATION NOTES

Stainless steel panels with handles are available as accessories. These panels are not installed at the factory.

Complete installation specifications, including panel sizes, can be found on our website, [subzero.com/specs](http://subzero.com/specs).

#### Location of Electrical Supply

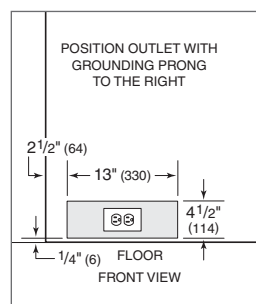

#### Location of Water Supply

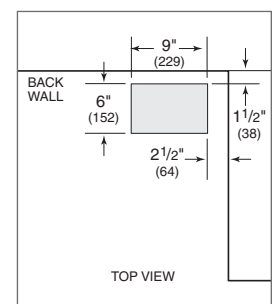
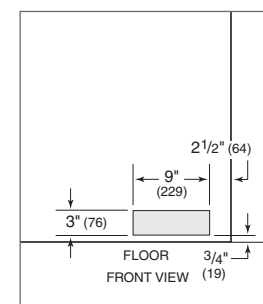

## Free Manuals Download Website

<http://myh66.com>

<http://usermanuals.us>

<http://www.somanuals.com>

<http://www.4manuals.cc>

<http://www.manual-lib.com>

<http://www.404manual.com>

<http://www.luxmanual.com>

<http://aubethermostatmanual.com>

Golf course search by state

<http://golfingnear.com>

Email search by domain

<http://emailbydomain.com>

Auto manuals search

<http://auto.somanuals.com>

TV manuals search

<http://tv.somanuals.com>