

**FELIX STORCH, INC.  
SUMMIT APPLIANCE DIVISION®**

**INSTRUCTION MANUAL FOR MODEL(S):**

**All Variations of the FF-6**

**All Variations of the FF-7**

**& All Variations of the SCR-600L/SCR-600BL**



**ALL-REFRIGERATOR**

Write the model and serial numbers here:

Model# \_\_\_\_\_  
Serial # \_\_\_\_\_

Find these numbers on the back of the unit

## TABLE OF CONTENTS

Before Putting into Use...3

### IMPORTANT

Disposing of worn out Appliance....4

### Placing and Installation

Choosing the right Place.....5

Connection to Power Supply.....5

Operation Control.....6

Temperature Selection.....6

### Use

Storing Fresh Food.....7

### Maintenance and Cleaning

Automatic Defrosting of the Refrigerator.....8

Cleaning the Appliance.....8

Reversing the Door.....9

Adjusting the Level Legs.....10

Troubleshooting.....10-11

Noise.....12

## **\*BEFORE PUTTING INTO USE\***

- ✚ Before connecting the appliance to the power supply, **leave it standing for about 2 hours**, this will reduce the possibility of malfunctions in the cooling system due to transport handling.
- ✚ Clean the appliance thoroughly; especially in the interior (See Cleaning and Maintenance).

### **Instructions for Use**

These instructions for use are intended for the user. They describe the appliance and the correct and safe way to use it. **The instructions were prepared for various types/models of refrigerators therefore you may find in it descriptions of some accessories and functions that your appliance may not have.**

### **Mounting Instructions**

Integrated appliances are equipped with instructions for mounting the appliance into the kitchen unit. **The appliance should be mounted by qualified technicians and instructions are for their use only.**

## **We Care for the Environment**

---

- ✚ Our appliances are distributed in packaging made of environmental friendly material which could safely be recycled, disposed of or destroyed without any effects on the environment whatsoever.
- ✚ Our instruction manuals are printed either on recycled paper or chlorine free bleached paper.

## **Tips for Energy Savings**

---

- ✚ Try not to open the door too often, especially when the weather is hot and humid. Once you open the door try to close it as soon as possible.
- ✚ Every now and then check if the appliance is sufficiently ventilated (adequate air circulation behind the appliance).
- ✚ Set thermostat from higher to lower settings as soon as possible (depending on how loaded the appliance is ambient temperature etc...).
- ✚ The coils on the rear of the refrigerator should be cleaned and free of dust or any impurities.
- ✚ Always consider instructions stated in sections Positioning and Energy Saving Tips, otherwise the energy consumption is substantially higher.

# IMPORTANT

---

- ✚ If you bought this appliance to replace an old one equipped with a lock that cannot be opened from inside (lock, bolt), **make sure that the lock is broken. This will make it impossible for children to lock themselves inside the appliance and suffocate.**
- ✚ The appliance must be correctly connected to the power supply.
- ✚ If the food has a strange smell or color throw it away because it is very likely that it is spoiled and therefore dangerous to eat.
- ✚ Disconnect the appliance from the power supply before repairing (only a qualified technician should repair it), cleaning and before replacing the light bulb.
- ✚ Use only enclosed tools or tools recommended by the manufacturer.
- ✚ The refrigerating system of the appliance is filled with refrigerant and oil, so when the appliance is damaged handle it with care and dispose of it in compliance with the environmental protection precautions.
- ✚ **Before throwing away your old refrigerator or freezer please remove the doors and leave the shelves in place so that children may not easily climb inside.**
- ✚ The rating plate is inside the appliance or outside on the rear wall.

## DISPOSING OF THE WORN OUT APPLIANCE

---

- ✚ **The refrigerating system of the appliance is filled with refrigerant and insulating substances which should be separately treated and processed.** Call your nearest authorized service agent or specialized servicing center. If they cannot be contacted, call your local authorities or your distributor to remove the refrigerator. **Be careful not to damage the tubes on the rear wall of the appliance (danger of pollution).**

## PLACING AND INSTALLATION

---

- ✚ It is important to make sure the appliance is leveled evenly to prevent falling.
- ✚ **Two spacers attached to the appliance must be fitted onto the upper edge of the condenser, thus preventing the appliance from being installed too close to the wall.** Spacers are manufactured for all-purpose functions depending on the distance of the condenser from the wall. Therefore turn spacers correspondingly and adjust them accordingly to the appliance.

## CONNECTION TO POWER SUPPLY

---

Connect the appliance with the cable and plug to the power supply socket outlet with a ground terminal (safety socket).

### **“DO NOT USE AN EXTENSION CORD.”**

Required nominal voltage and frequency are indicated on the rating plate. The connection to the power supply and grounding has to be made according to current standards and regulations. The appliance resists temporary voltage tolerance up to -15 to 10%.

# OPERATION CONTROL

## How To Adjust The Thermostat

The refrigerator is controlled with a thermostat knob located inside unit, towards the right-hand corner. Turn the knob clockwise from the **STOP (0)** position toward higher numbers for colder temperatures.

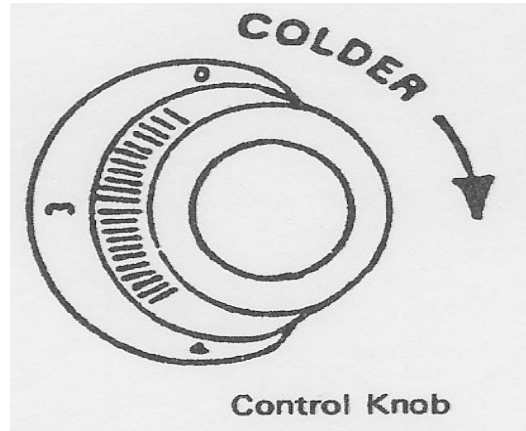

## TEMPERATURE SELECTION

The settings of the temperature control are from 0 (off) to 7 (max). Initially adjust the temperature control setting to 4 (norm), then adjust the thermostat to colder or warmer (as needed).

**A higher setting on the knob (towards 7) means colder temperatures in all compartments of the appliance.** On the highest setting, parts of the refrigerator may become extremely cold, especially in cooler or dry weather. Use the higher thermostat setting only when required or recommended.

**The coolness of the refrigerator depends on how often you open and close the door.**

**To turn the refrigerator off you must turn the thermostat to 0 (off).**

---

Instructions for Use

---

## STORING FRESH FOODS

---

- ✚ Foods to be stored in the refrigerator should be properly packed as to prevent mixing various moisture degrees and odors (in polyethylene bags or sheet, aluminum foil, wax paper, covered containers or bottles).
- ✚ Never store any inflammable, volatile or explosive substances.
- ✚ Beverages with high alcohol percentage shall be stored in tightly sealed bottles in a vertical position.
- ✚ Food should not touch the rear wall of the refrigerator.
- ✚ Some organic solutions like volatile oils in lemon and orange peel, acid in butter etc. can cause damages when in contact with plastic surfaces or gaskets for a long period of time.
- ✚ An unpleasant odor inside the refrigerator is a sign that something is wrong with the food or that your refrigerator needs cleaning. Odors may be eliminated or reduced by washing the interior of the refrigerator with a mild solution of water and vinegar. We also recommend using activated carbon filters to clean the air or to neutralize odors.
- ✚ If you plan on taking a long trip make sure you remove all perishable food before you leave to prevent any odors.

---

### Instructions for Use

## AUTOMATIC DEFROSTING

---

**There is no need to defrost the refrigerator, because the ice depositing on the inner back wall is defrosted automatically.**





Ice may deposit on the inner back wall during the compressor operation; later on when the compressor is not operating, the ice is defrosted and the water is collected and drained through the outlet in the inner back wall into the drain pan situated above the compressor where it is evaporated.

---

## CLEANING THE APPLIANCE

---

**Disconnect the power supply before cleaning the appliance. Do not use coarse or aggressive cleaning agents as you can damage the surface.**

-  Clean the **exterior** with water and a mild detergent. Varnished surfaces are cleaned with soft cloth and a non-abrasive cleaning agent (for example glass cleaners). **You may also use stainless steel cleaner if you have a stainless steel model.**
-  Remove the detachable accessories in the interior of the appliance and clean it with water and liquid detergent. Plastic parts **cannot** be washed in a washing machine.
-  **Wash the interior of the appliance with lukewarm water, in which you add one or two spoonfuls of vinegar.**
-  Every now and then wipe the condenser on the rear wall. Use a **soft non-metal brush.**
-  **Do not forget to clean the defrost water receptacle above the refrigerators compressor (do not remove the receptacle). After cleaning, connect the appliance to the power supply and reload the packages.**

---

## SWITCH OFF THE APPLIANCE WHEN NOT IN USE

---

**If you do not intend to use the appliance for an extensive period of time, set the thermostat knob to the STOP (0) position and disconnect the power supply. Then take out the foods and clean the appliance. Leave the door slightly open.**

---

Instructions for Use



## **DOOR SWING REVERSAL**

**(Stainless steel models with towel bar handles do not have reversible doors.)**

If you find the direction of opening the door on your appliance inconvenient, you can change it. Holes on the opposite side have already been prepared at the factory

- 1. Remove the top hinge cover and hinge (on models with a tabletop, remove the bottom hinge instead).**
- 2. Next remove the door and remove the bottom hinge.**
- 3. Then remove the kick plate, slide it over to the opposite side and secure in place.**
- 4. Place the lower hinge on the opposite side of the unit and reattach the door,**
- 5. Reattach the top hinge on the opposite side of the unit, it should be aligned with the bottom hinge**
- 6. Remove handle by unscrewing, place on the opposite side and secure in place.**
- 7. Insert plugs into the holes where the door was initially attached.**
- 8. Check to make sure the door seals properly.  
(If it does not, use a hair dryer set on medium to expand the gasket.)**

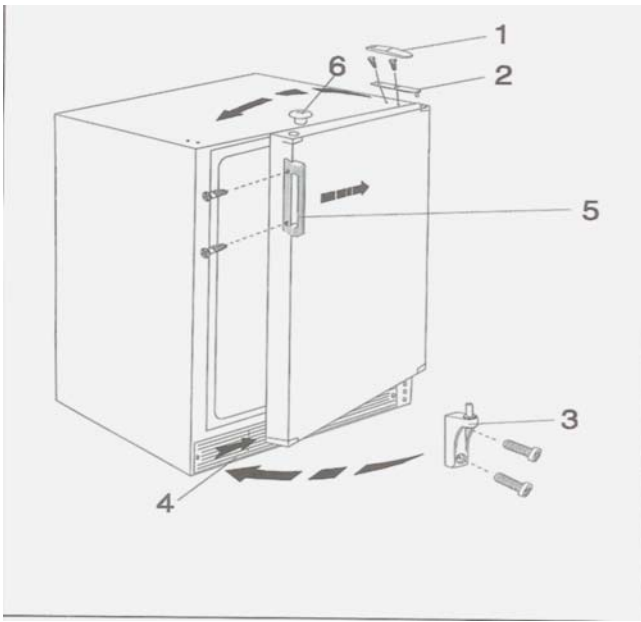

- |                             |                      |
|-----------------------------|----------------------|
| <b>1. Upper hinge cover</b> | <b>4. Kick plate</b> |
| <b>2. Upper hinge</b>       | <b>5. Handle</b>     |
| <b>3. Lower hinge</b>       | <b>6. Hole Plugs</b> |

## ADJUSTING THE LEVEL LEGS

The Professional units (those with a *BI* suffix in model number) have 4 adjustable level legs. By turning the legs counter-clockwise you can increase the height of the unit up to 34" inches high or you may decrease the height to about 33" inches by turning clockwise.

**On Non-Professional models**, there are only two adjustable levels legs in the front of the unit. The two rear legs are stationary; it is not recommended that you adjust the front level legs.

## TROUBLE-SHOOTING GUIDE

---

During the service of your appliance, you may come across some troubles that in most cases result from improper handling of the appliance that can easily be eliminated.

### **Problem #1**

#### **Appliance Fails to Operate After Connecting to the Power Supply**

##### Possible Cause/Solution

- \*Check to make sure the appliance is switched ON  
(thermostat is in the operating position)
- \*Check to the power of the A/C outlet (plug in a lamp to test)
- \*Check for a failed fuse
- \*Refrigerator line cord may not be plugged in properly

---

### **Instructions for Use**

#### **Problem #2**

## Ice Formation on the Inner Rear Wall

### Possible Causes

- \*The door does not seal well (clean the gasket if it is contaminated, or replace it if it is damaged).
- \*The door was frequently opened or it was left opened for too long.
- \*The food stored in the refrigerator was warm.

### Solution

**-As long as the defrost water runs through the channel, out of the opening and into the drain pan on the compressor, automatic defrosting of the appliance is assured.** *In case the ice formation on the inner back wall is increased (1/8"), ice should be manually defrosted.*

**Set the thermostat knob to STOP (0) position and leave the door open. Never use electric devices for defrosting and do not scrape the ice or frost layer with sharp objects.** After defrosting is complete, turn the knob to desired position and close the refrigerator door.

## Problem #3

## Water is Leaking from the Refrigerator

### Possible Cause/Solution

In case the water discharge outlet is clogged, or the defrost water drips over the channel causing water to leak from the refrigerator, try the following suggestion:

- \*Clean the clogged opening with a plastic straw
- \*Manually defrost the increased ice layer according to instructions listed above.

---

Instructions for Use

**NOISE**

- ✚ **After starting the appliance, the operation of the compressor and the refrigerant flow may be louder and this does not mean something is wrong with the appliance. The noise will reduce gradually.**
- ✚ During the operation of the compressor, a liquid noise is heard and when the compressor is not operating a refrigerant flow is heard. This is a normal condition and it has no influence whatsoever on the lifetime of the appliance.
- ✚ Sometimes strong noises occur which are rather unusual for the appliance. **This noise is often a consequence of inadequate placing. To avoid the noise make sure the appliance is placed and leveled firmly on a solid base; make sure the appliance is not touching the wall or kitchen units standing next to it.** And always make sure you check the accessories in the interior of the appliance; they should be placed correctly in their positions. Check the bottles, tins and other vessels that might touch each other and rattle.

#### **Before Calling for Service**

- ✚ **Check the plug and fuse.**
- ✚ **Test the outlet with a lamp**
- ✚ **Be sure the control is not set to OFF**
- ✚ **Read the manual, especially the items under the Use and Care sections. You may find the answer to your questions.**
- ✚ **If you don't find the answer to your questions in this manual, find the unit model number (on the upper back of the refrigerator) and contact your Summit Appliance Dealer.**

Specifications are Subject to Change Without  
Notice.

## Free Manuals Download Website

<http://myh66.com>

<http://usermanuals.us>

<http://www.somanuals.com>

<http://www.4manuals.cc>

<http://www.manual-lib.com>

<http://www.404manual.com>

<http://www.luxmanual.com>

<http://aubethermostatmanual.com>

Golf course search by state

<http://golfingnear.com>

Email search by domain

<http://emailbydomain.com>

Auto manuals search

<http://auto.somanuals.com>

TV manuals search

<http://tv.somanuals.com>