

summo

HIGH RESOLUTION SUMMING AMPLIFIER

Operational Manual

Version 1.0 – October 2004





Copyright 2004. All rights reserved.

The information in this document is subject to change without notice.

Audient plc makes no warranty of any kind with respect to the material in this document and shall not be liable for errors contained herein or for incidental or consequential damages related to the use of the material.

No part of this document may be reproduced without the prior written consent of Audient plc.

Thank you for buying this  product.

As can be found throughout the Audient range, your Sumo has been painstakingly designed and lovingly nurtured to give you years of productive, reliable, mix fattening performance. To make the most of this, we suggest that you have a good look through this manual before you get started.

The safety and installation information will help you to set your Sumo up with the minimum of danger and hassle, while the operational guide will take you on a whistle stop tour of Sumo's knobs, dials and flashy lights – along with some handy hints for their use. Finally, if you're experiencing any problems Sumo Surgery will root out most set-up and configuration issues to get you back on track in no time.



Anywhere you see this symbol, you should make sure to read the adjacent warning. These will prevent you from killing yourself, blowing up speakers, and wrecking your mix. All of which are to be avoided.



Text next to one of these symbols is, wait for it... a handy hint. These are little operational titbits and guidelines to help you find your way and get the most out of your Sumo.

CONTENTS

SAFETY INFORMATION	5
INSTALLATION	7
OVERVIEW - THE BENEFITS OF ANALOGUE SUMMING	8
PLUGS AND SOCKETS	
Analogue audio interfaces	10
Digital interfaces	11
HOOKING UP	12
KNOBS, BUTTONS AND FLASHY LIGHTS	
Input section	15
Mix Compressor/Peak Limiter	16
Mix master/monitor section	17
Digital section	18
SUMO SURGERY (TROUBLESHOOTING)	19
Why can't I hear anything?	20
ACCESSORIES	21
SPECIFICATIONS	21
WARRANTY	22

IMPORTANT SAFETY INSTRUCTIONS

CAUTION	ATTENTION
RISK OF ELECTRIC SHOCK DO NOT OPEN	RISQUE DE CHOC NE PAS ENLEVER

WARNING		
	THIS EQUIPMENT MUST BE EARTHED. DO NOT EXPOSE TO RAIN OR MOISTURE.	

Please read all of the following instructions and save them for later reference before attempting to connect your Sumo to the AC power source.

SAFETY INFORMATION

- EARTH** This unit is connected via its power cord to the mains safety earth. NEVER OPERATE THE UNIT WITH THIS EARTH CONNECTION REMOVED.
- COVERS** DO NOT remove the covers. Refer servicing to qualified personnel only.
- VOLTAGE** Sumo is set to operate only at the voltage shown on the rear panel. CHECK that the correct voltage is available before connecting the AC mains supply.
- FUSES** CHECK that the fuse fitted is of the correct type for the local mains voltage. ALWAYS replace fuse with the correct type.
- MOISTURE** DO NOT expose the unit to rain or moisture. If your Sumo should become so exposed REMOVE the mains power immediately.
- HEAT** ALWAYS site the Sumo away from sources of heat including direct sunlight and ensure adequate ventilation around the unit.

INSTALLATION

Unpacking

Your Sumo has been carefully and meticulously tested before despatch.

Please check for any signs of transit damage. If any signs of mishandling are found please notify the carrier and your dealer immediately.

Mains Power Supply

Fuses

Sumo can be switched to operate at mains voltages of either 230V or 115V. With the switch in the 230V position, the unit will operate without performance degradation from 210V to 250V. In the 115V setting, voltages from 105V to 125V will be accepted. Do not attempt to operate the unit outside the relevant range defined above. For 100V operation, please contact your dealer.

Please note that the fuse ratings are different for each of the voltage ranges. 20mm T250mA for the 230V setting and 20mm T500mA for 115/100V.

The mains fuse is very unlikely to fail under normal use and caution should be exercised if a failure should occur. Check the mains voltage, the condition of the mains cord and the integrity of the mains supply before replacing the fuse.

Mechanical Installation

Care should be taken not to obstruct the unit's ventilation holes. Adequate airflow must be provided within rack cases above and below the unit to prevent overheating.

OVERVIEW - THE BENEFITS OF ANALOGUE SUMMING

Having bought the unit, you've probably figured out that Sumo is a high-resolution summing amplifier with stereo bus compressor and peak limiter, not to mention a handy little monitor section. Nevertheless, here are a few more interesting and descriptive words with which to impress your inquisitive friends.

In essence, Sumo takes a bunch of signals from several inputs and adds or "sums" them together to present them to one output. This is exactly the same process as takes place in mixing consoles – the mix bus sums signals from all of the channels together.

"But my software has a mixer. Why can't I just use that?" I hear you cry. Digital summing has one crucial problem; that the output bit depth is equal to or less than each of the internal signals. This means that when signals are summed, some data must be thrown away.

Moreover the volume of data discarded in this process increases with your track count. It would, of course be unfair to suggest that modern software performs this data reduction indiscriminately or with especially poor results, however many engineers and producers have found there to be something lacking in their digital mixes – often employing an analogue console purely to make use of its summing bus.

So what's so special about the mix bus on a big console? Well... only the highest of high end, large format consoles employ balanced mix buses to reduce crosstalk and fend off noise. And this is precisely the kind of mix bus you'll find in your Sumo, delivering the sound of a large format console without the huge footprint, or price tag.

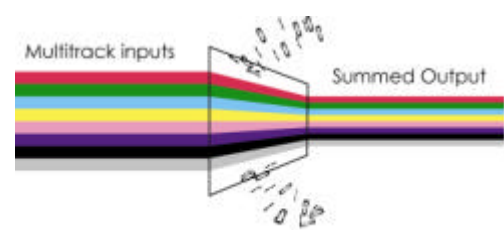

Summing in the digital domain.



Summing in the analogue domain.

Not only is Sumo's summing bus as clean as a whistle, it has frighteningly high headroom. This is particularly important because adding signals means adding their levels, too. The more signals you add, the more level you're likely to find on the sum bus. Consequently, Sumo has been designed to handle levels in excess of +28dBu.

This means that Sumo can take whatever you throw at it without distortion or noise.

Another feature of large format studio consoles is the inclusion of a compressor over the main stereo bus. Consequently, the bus compressor from the ASP8024 has also been included in Sumo's design: a flexible, high quality compressor capable of polishing a mix to perfection. And there's more; we've added in a digital equipment guarding, mix fattening peak limiter to help your mix stand out without risking nasty digital distortion.

To cap it all off, the monitor section gives you hands-on control of your playback level while the external input allows you to A/B your mixes against some reference material, or listen to the playback from your master recorder.

Optional Extras

If your Sumo is equipped with a digital card, you'll be able to output a stream of lovely 0s and 1s at rates of up to 192kHz on both AES/EBU and S/PDIF standards.

As your studio and track counts expand, you can expand your sumo system with the addition of up to 3 units, giving you a total of 64 inputs. If you are feeling particularly track hungry, then each of the expansion units can provide 3 more expansion inputs etc. etc...

PLUGS AND SOCKETS

Audio Interfaces

The 16 inputs are connected via two Tascam DA88 type female D-Sub connectors. Interconnect cables are readily available in pre-wired form from Audient and from any good cable manufacturer. You can get these with different tail types to suit your other equipment, see the accessories section on page 18. Always use balanced connections to reduce any cable interference and noise.

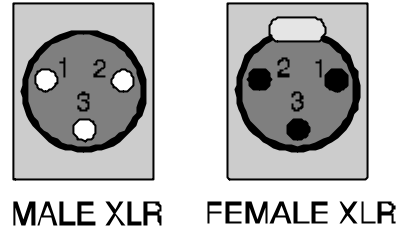

Inserts are connected via TRS (Tip-Ring-Sleeve) jacks. Rather than an unbalanced loop on a single cable, there are separate jacks for sends and returns, providing balanced connections throughout.

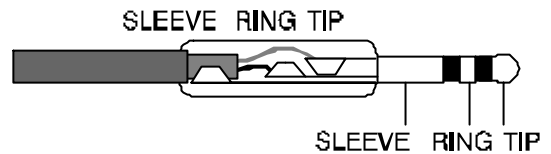
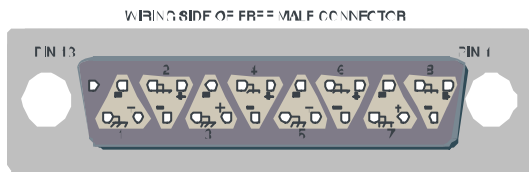

Channel Number	+ve signal	-ve signal	Screen
	D-Sub Pin		
1	24	12	25
2	10	23	11
3	21	9	22
4	7	20	8
5	18	6	19
6	4	17	5
7	15	3	16
8	1	14	2

Note: All undesignated pins are unconnected. All screen connections are joined inside the unit and connected to metalwork earth.

A third D-Sub connector (which breaks out to XLRs) can provide extender linking and an external monitor input. The first two channels connect the external input to the monitor section, while the remaining three pairs of channels allow additional Sumo units to connect directly into the mix bus.

Outputs are provided on male XLR connectors: two for the main outs and two for your monitors.

All of Sumo's analogue audio connections operate at +4dBu, the professional standard, so you may need to 'pad' outputs fed to semi-pro equipment.

Pin conventions

To unbalance the outputs of the Sumo the -ve Pin should be connected to its adjacent 0v pin at Sumo's output.

Similarly, inputs from unbalanced sources should be connected via twin screened cables with the -ve pin connection tied to the screen at the unbalanced source. Inputs and outputs are implemented using advanced electronically balanced topologies and are fitted with extensive RFI rejection networks.

Digital Interfaces

The optional digital card gives Sumo the ability to output at six sample frequencies up to and including 192kHz.

AES/EBU on XLR, and S/PDIF on RCA (that's a phono plug to you and I). Output on both connectors, for all sample rates is fixed at 24bit.

A word clock input is also provided for situations where Sumo is not the clock master. This is connected via BNC.



The card provides for both of the most common stereo digital transmissions standards:

HOOKING UP

Before starting, it's always a good idea to make sure that your monitor speakers are muted and/or turned off – this ensures that nothing gets popped or blown up when cables are being fiddled with and while power is turned on.

Analogue Connection

(see Figure 1, on next page)

1. Connect the outputs of your DAW's interface and any other sources to Sumo's inputs. If your DAW's interface can output at -10dBV or +4dBu, select the latter. This is the professional standard and will allow you to make the most of Sumo's excellent headroom.
2. Plug the Monitor Outputs of Sumo into your monitor amplifier, or directly into your powered monitors. Make sure you have the monitor volume right down at this point, to protect the speakers when you switch them on.
3. Attach Sumo's main outputs to your master recorder such as a DAT machine or CD recorder, or even right back into your DAW.

This stage is pretty important, because you're converting back into the digital domain and the quality of this conversion will effect your overall mix, so make sure to use the best converters you have available. If you would like to improve your AD conversion, consider Sumo's digital conversion option, which produces top notch AES/EBU and S/PDIF straight out the back of the unit.

! If you are connecting straight back into your DAW, you'll have to make sure that the track you record on is either muted or not routed to Sumo else you'll get feedback. And nobody likes feedback.

Digital Connection

(see Figure 2, below)

4. If using a word clock master, connect the master source to the BNC connector on the digital card (see "Knobs, Buttons and Flashy Lights" for details on setting up your digital card).
5. Connect the digital outputs to your digital master recorder or DAW.

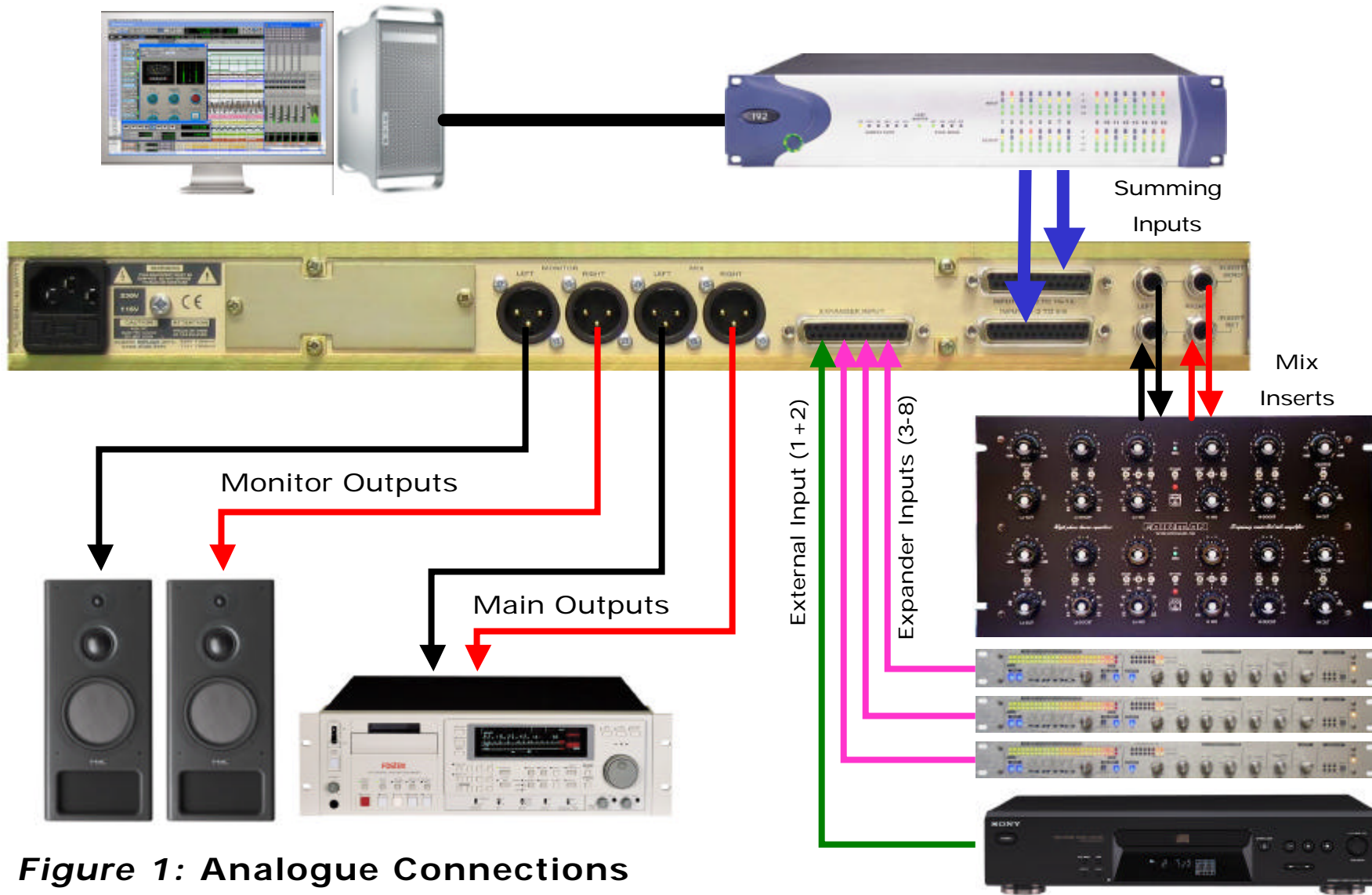

Figure 1: Analogue Connections

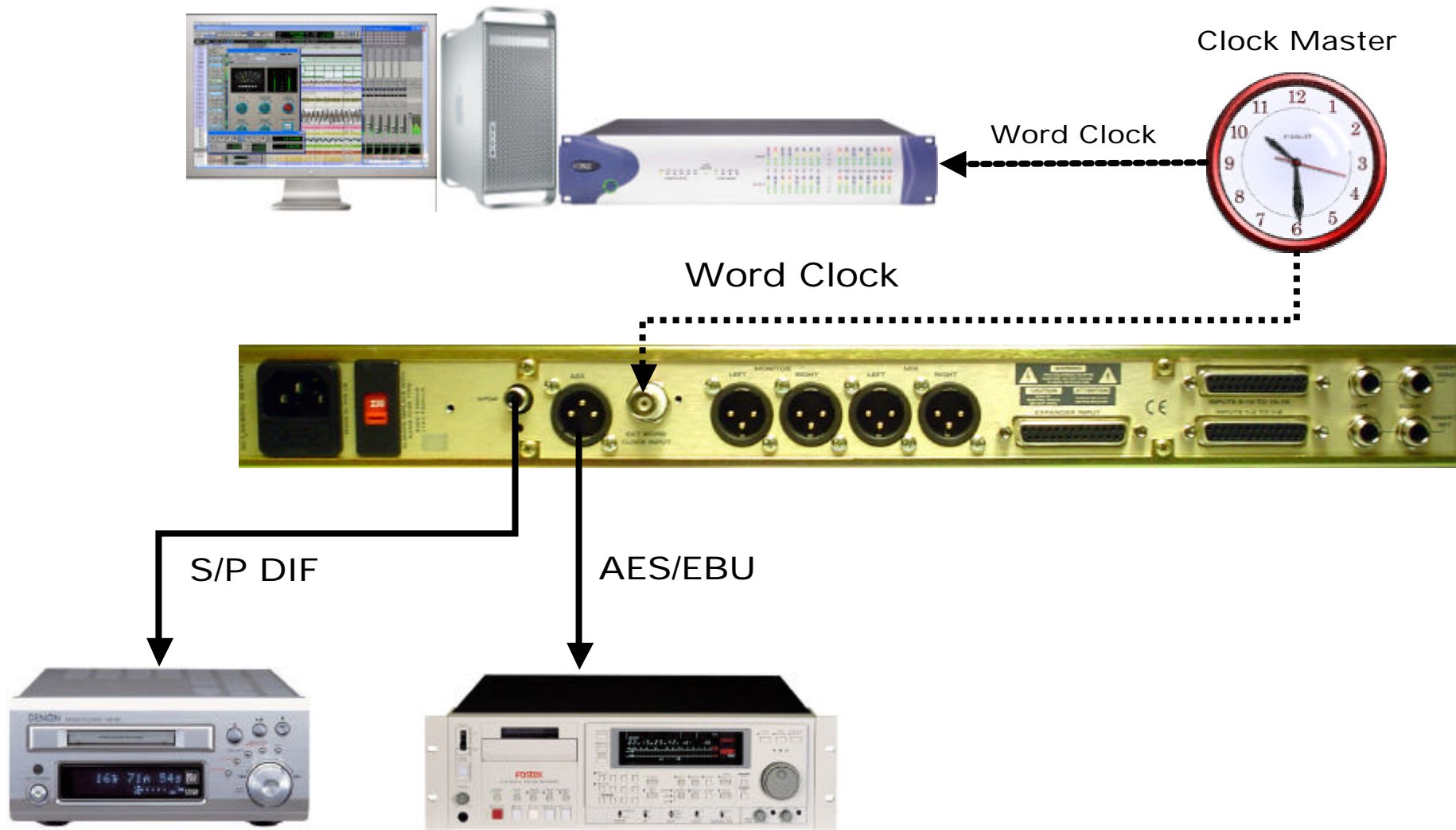
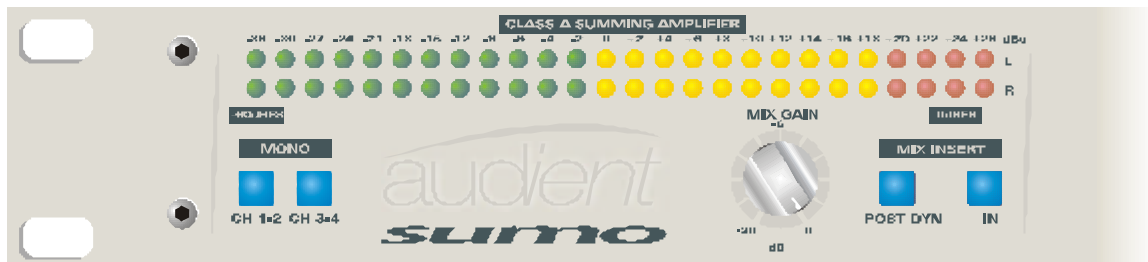

Figure 2: Digital Connections

KNOBS, BUTTONS AND FLASHY LIGHTS

Input Section



MONO Buttons – Under normal circumstances, all of the odd numbered channels entering Sumo are routed to the left side of the bus, while even numbers are routed to the right. Of course, this is going to sound a little unusual if your kick drum appears on the left and your snare is on the right, etc. So the first two channel pairs (1/2 + 3/4) can each be mono'd, effectively panning them dead centre, right where you want them. Also, routing mono sources through a single channel saves outputs from your DAW.

Mix Gain – This control gives you a pre-dynamics gain trim from -20 to 0dB, so even if you've been especially normalize-happy whilst editing, you won't have any problems with headroom, either within Sumo or, more likely, with any attached inserts.

MIX INSERT Switches – These buttons refer to the insert connections on the back panel. Use these if you want to add your own EQ, compression, or anything else you can think of. The 'In' switch puts the inserts in circuit, breaking the signal path if nothing is connected.

The 'Post Dyn' switch allows you to alter the position of the inserts in the chain: before (pre) or after (post) the internal compressor and limiter.

Be careful of boosting with an inserted unit when in post-dynamics mode as the limiter is no longer able to protect the output level. This is particularly important with digital gear, where overs must be avoided at all costs.

Output Meter – This meter will display system output level in dBu for either the main sum bus or two track input; whichever is selected in the monitor section. Or whichever source you are listening to, if you like. The legend beneath the meter shows how the analogue levels relate to digital output when the digital card is installed. If you wish to line the analogue inputs of your digital gear up to match the meters, 0dBu should equate to -24dBFS.

MIX COMPRESSOR/PEAK LIMITER

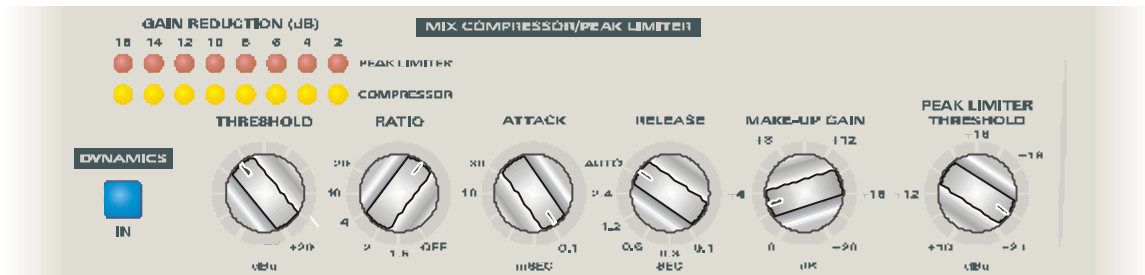

DYNAMICS 'In' Switch – Puts both compressor and limiter in circuit. When the dynamics are out, they are hard bypassed, clearing the signal path of any unnecessary components.

Threshold – Sets the point at which compression begins to work. Due to the soft-knee characteristic of the compressor, some slight gain reduction is applied before the threshold level. This gives the compressor a gentler, more musical response.

Ratio – Varies the amount of compression. The numbers on the dial show the number of decibels that must be

put in above the threshold to get one more dB out. The greater the number, the harder the compression. The diagram below shows how the compressor affects the input/output ratio at different ratio settings. The off position allows you to bypass the compressor whilst leaving the limiter in place. Dead handy if, heaven forbid, you're inserting a compressor of your own.

 Use high ratios with high thresholds to control rogue peaks, or low ratios with low thresholds to apply a more gentle overall compression.

Attack – The time for which the input signal must rise above the threshold level before the compressor takes effect.

Dynamics Responses

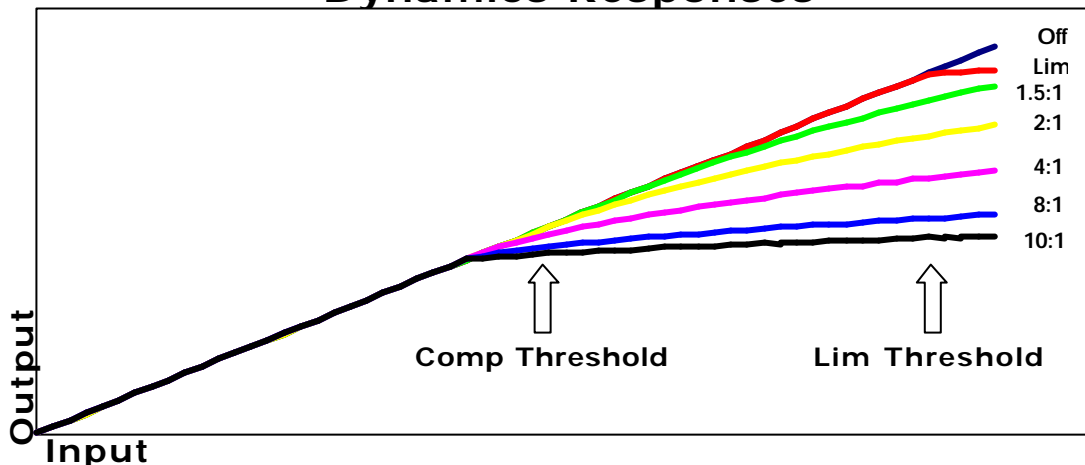

Adjusting this will vary the way the compressor handles transient sounds.



Where control of unruly transients is required, a faster attack will clamp down on peaks. However, if larger amounts of gain reduction are applied, unnecessarily fast attack times may affect high frequency content.

The **Peak Limiter's** response is fast attack, fast release, and very hard. It has two functions: Firstly, as a protective device it can remove the dangerous peaks that can result in digital clipping. Secondly, it can be used to increase the average signal level (as your ear detects volume by averaging over time) and increase the perceived loudness of your mix within the confines of a recording medium: Great if you want your CDs to sound as loud as the pros'.

Gain Reduction Metering – Two independent meters show gain reduction at the compression *and* limiting stages, so you immediately know where any adjustments need to be made.



As a rough guide, 3dB of reduction with a fairly high ratio should be pretty inaudible. If you're looking for a more general squashing, values of up to 6dB with a lower ration (1.5 or 2) should give some good results. However, be aware that for the limiter and fast attack settings of the compressor, reduction may occur faster than the meters can show it, so take this into account and trust your ears!

Be particularly careful of peak limiting: reduction in excess of 6dB may well cause adverse effects such as chewing up your top end.

MIX MASTER / MONITOR

Section

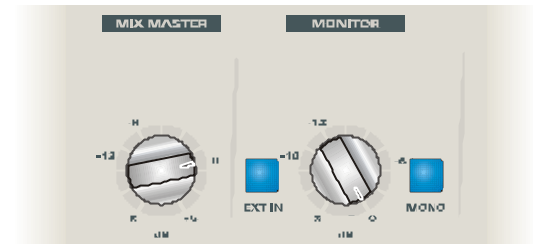

MIX MASTER – Is the final gain control before the mix leaves the unit, or enters the digital card. This is useful as a final adjustment after any gain changes brought about by dynamics and inserts.

'Ext In' Switch – Switches the external input into the monitor path. Use this to monitor playback from your master recorder, or perhaps to check your mix against reference material.

MONITOR Volume – Say no more.

Monitor Mono Switch – allows you to check phase coherence, etc. by summing the monitor outputs in mono.

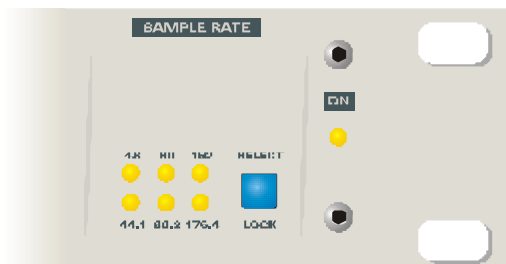

Digital Section

SAMPLE RATE – Rates of 44.1, 48, 88.2, 96, 176.4 and 192kHz are supported. The desired sample rate can be selected by pressing the select button repeatedly whereby the sample rate will cycle through internal rates and then the external Word Clock source.

Lock – When the external clock source is selected, the select switch will flash until the converters are synchronised, or 'locked', with the external source. When lock is achieved the light will glow solidly.

When using Sumo as a Word Clock Master, set any attached recorders to take wordclock from their AES/EBU or s/pdif input (the one that's connected to Sumo).

SUMO SURGERY (TROUBLESHOOTING)

Symptoms	Diagnosis	Remedy
The power light is off.	The fuse is blown.	The power connector at the back contains the main fuse. Try changing this, using a correctly rated replacement for your local mains voltage (see back panel).
The power light is off.	The unit is set for the wrong mains voltage.	Ensure that the red switch on the back of the unit matches your local mains voltage. Make sure the unit is disconnected before switching this.
The power light is off.	The power cable is disconnected.	Reconsider your chosen career. Perhaps you should retrain. Can you say "Would you like fries with that"?
I can't hear anything!	Could be one of many things.	See the flowchart below.
My external input source is coming through the mix bus.	The external input source is connected to an expander input.	Ensure that the external input source is connected to inputs 1+2 of the expansion D-Sub connection.
All I can hear is a strange hissing noise.	A T-DIF device is attached to Sumo's inputs. Although the plugs match, Sumo's inputs are analogue while T-DIF is digital.	Attach your device using its analogue connections.
I've inserted another device and it is distorting really badly.	Sumo is capable of handling levels of up to +28dBu, unlike most outboard units, which can usually only take up to about +20dBu.	Use the mix gain control to drop the bus level so you don't fry your outboard.
My kick drum is only coming out of the left speaker.	The channel carrying your kick drum is part of a stereo pair.	In software, route all the tracks you want centred to inputs 1-4 of the Sumo. Then switch in Sumo's mono buttons, and hey presto!

Why can't I hear anything?

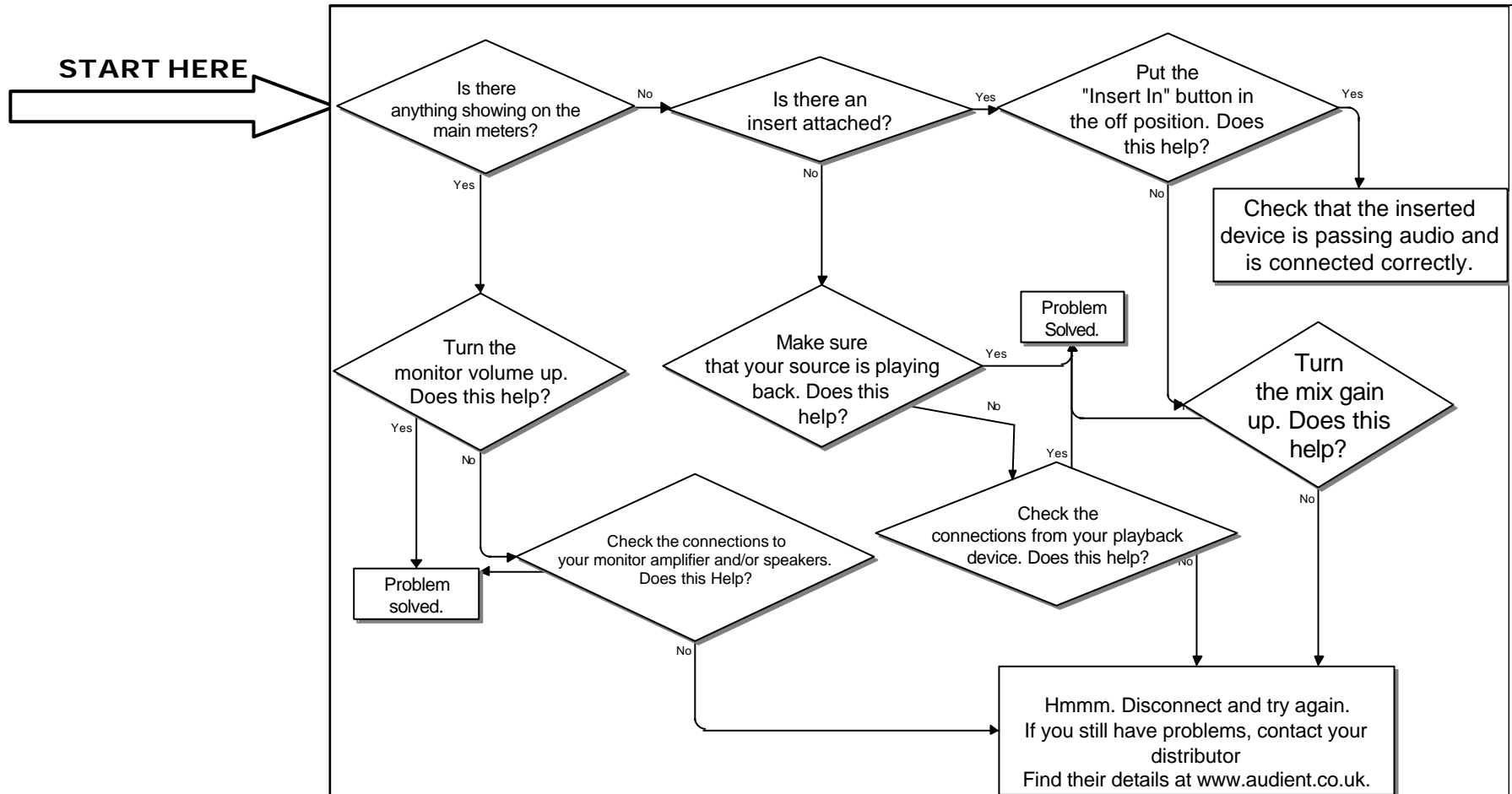

ACCESSORIES

A range of accessories is available to hook up to other gear or expand your Sumo system. All cables are of the highest quality and will perfectly complement your Sumo in any set-up. For alternative terminations or lengths, contact your Audient dealer.

Description	Order code
3 Metre Analogue 25 pin D-Sub to 8 Female XLR Ideal for linking to audio interfaces and other Sumo units.	ASPDTF-803
3 Metre Analogue 25 pin D-Sub to 25 pin D-Sub Ideal for connection to Pro Tools HD systems.	ASPDBD-310
Sumo 192kHz AES/EBU & S/PDIF digital output card	SUMO-AES

SPECIFICATIONS

Frequency Response	22Hz-22kHz +/- 0.1dB (-3dB @ 135kHz)
Noise	< -92dBu
Maximum Input Level	> +28dBu
Dynamic Range	120dB
Headroom (overload margin)	> 24dB ref +4dBu, 27dB ref +4dBu in mix amp
Distortion	< 0.003% @ 1kHz, +28dBu
Crosstalk	< -80dB @ 1kHz
Input Impedance	> 10kO differential
Output Impedance	< 75O electronically balanced
Dimensions	480mm x 278mm x 44mm
Weight	4.5kg
Power Consumption	40 Watts

In keeping with our policy of continuous improvement, Audient plc. Reserves the right to alter these specifications without prior notice.

WARRANTY

Your Sumo comes with a manufacturers warranty for one year from the date of despatch to the end user.

The warranty covers faults due to defective materials used in manufacture and faulty workmanship only.

During this warranty period Audient will repair or at its discretion replace any faulty unit provided it is returned carriage paid to an authorised Audient service centre.

We will not provide warranty repair if in our opinion the fault has resulted from unauthorised modification, misuse, negligence, act of God or accident.

We accept liability to repair or replace your Sumo as described above. We do not accept any additional liability.

This warranty does not affect any legal rights you may have against the person who supplied this product – it is additional to those rights.

Free Manuals Download Website

<http://myh66.com>

<http://usermanuals.us>

<http://www.somanuals.com>

<http://www.4manuals.cc>

<http://www.manual-lib.com>

<http://www.404manual.com>

<http://www.luxmanual.com>

<http://aubethermostatmanual.com>

Golf course search by state

<http://golfingnear.com>

Email search by domain

<http://emailbydomain.com>

Auto manuals search

<http://auto.somanuals.com>

TV manuals search

<http://tv.somanuals.com>