

Sungate



AD801

Digital Photo Frame User's Manual



For ongoing product improvement, this manual is subject to modification without prior notice.

Download from Www.Somanuals.com. All Manuals Search And Download.

Contents

User Notice

As this product has met electronic emission standards in registration for use at home, it can be safely used in all areas, including residential.



Chapter 1 Introduction

Product Introduction	3
Safely Precautions	4
Components	6
Player Overview	7

Chapter 2 Connection

Connection	12
Memory Card Extraction	15
PC Connecting	16

Chapter 3 Usage

Photo	18
Music	20
Back Music	22
Movie	23
Additional Functions	25

Chapter 4 Editing & Settings

Editing	28
Settings	31
Calendar	36
ASSP Store Technology	37

Chapter 5 Customer Management

Question&Answer	39
Troubleshooting	41
Product Specifications	42
FCC and Safety Information	43



Chapter 1

Introduction

Product introduction	3
Safety Precautions	4
Power Related	4
Product Related	5
Components	6
Basic components	6
Player overview	7
Electronic Frame	7
Remote Control	9

Digital Photo Frame

Product introduction

The Digital Photo Frame is a convenient image album that keeps your favorite images at your fingertips.

With its bright and vivid LCD screen, this Digital Photo Frame offers an alternative to photo printing, adding a new level of convenience to your life.

With its diverse file management functions, this Digital Photo Frame allows you to relive your cherished memories anytime.

Digital Photo Frame

Safety Precautions

Make sure to review the precautions to ensure user safety.

Power Related

⚠ WARNING: indicates information that, if neglected, could result in serious injury and/or death to the user.

⚠ CAUTION: indicates information that, if neglected, could result injury to the user and/or material damage.

01. Use only the authorized power supply product. Failure to do so could result in product malfunction.



02. When connecting the power source, make sure that your hands are free of moisture. Failure to do so could result in electrical shock.

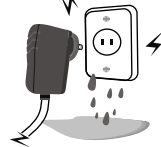

03. Make sure that the power supply is firmly plugged in and not loose. Failure to do so could result in electrical shock.

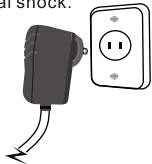

04. Do not let the power cord get overly entangled and do not place any heavy objects on the cord. Failure to do so could result in electrical shock.

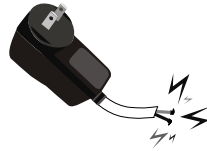

05. Do not connect the power supply to an electrical power strip with other various connections. Failure to do so could result in fire.

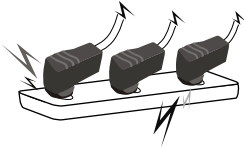

06. Disconnect the power supply during inclement weather conditions that include thunder and lightning. Failure to do so could result in fire.

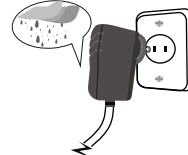

Digital Photo Frame

Safety Precautions

Make sure to review the precautions to ensure user safety.

Product Related

01. Dropping the product or subjecting it to a significant impact can cause critical damage.

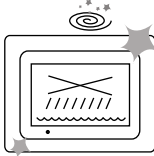

02. Spilling water or any other liquid on the product can cause critical damage.



03. Striking or scratching the LCD screen can cause critical damage.

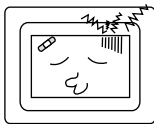

04. When cleaning the LCD screen, avoid damage by turning off the power and then wiping gently with a soft cloth.

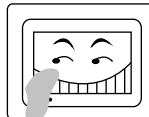

05. Subjecting the product to severe humidity and /or heat can cause damage.

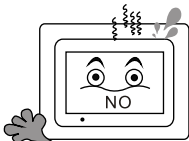

06. Make sure to turn the power off before connecting or disconnecting the power supply.

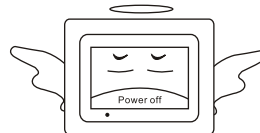

Digital Photo Frame

Components

For the improvement of product performance and/or quality, the basic components may be modified without prior notice. The components may differ slightly in appearance with the provided images.

Basic Components

The components are provided upon product purchase.

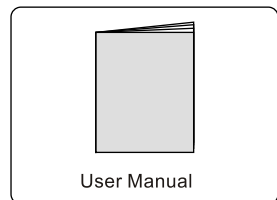
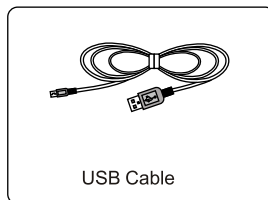
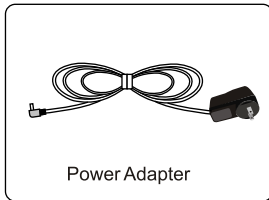
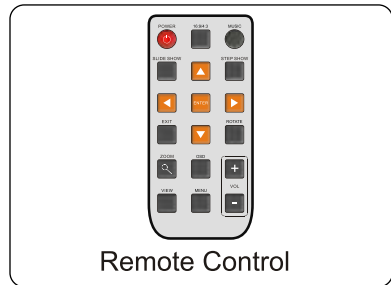
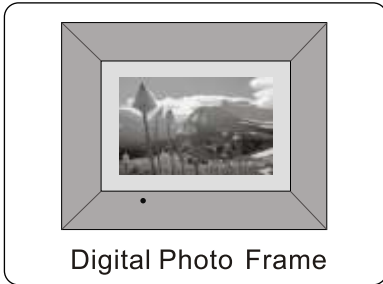

Digital Photo Frame

Player Overview

The components may differ slightly in appearance with the provided images.

Electronic Frame

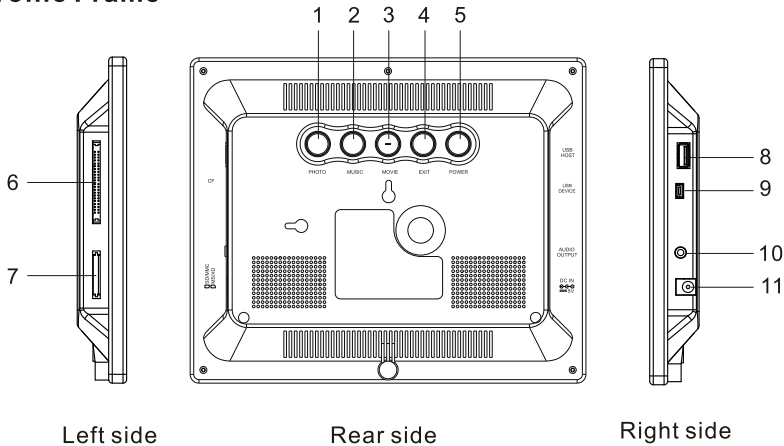

Rear side

- 1 .**PHOTO**: Press this button to start slide show of pictures.
- 2 .**MUSIC**: Press this button to start listening to songs.
- 3 .**MOVIE**: Press this button to start watching movies.
- 4 .**EXIT**: Press **EXIT** to exit current menu.
- 5 .**Power**: Switch the player between "on" and "off" modes.

Left side

- 6 .**CF CARD**: Insert CF card.
- 7 .**SD/MMC/MS/XD**: Insert SD/MMC/MS/XD.

Right side

- 8 .**USB HOST**: Connect the USB cable from the DPF player to U disk/Mobile hard disk.
- 9 .**USB DEVICE**: Connect the USB cable from the DPF player to PC.
- 10 .**AUDIO OUT**: Connect to audio equipment.
- 11 .**DC IN**: Input the DC power adaptor to the DPF player.

Digital Photo Frame

Player Overview

The components may differ slightly in appearance with the provided images.

Rear side

- 12. Wall Mountable
- 13. Speaker: Stereo speakers built-in
- 14. Stand: Using the stand provided you can stand the body with horizontal view and vertical view .

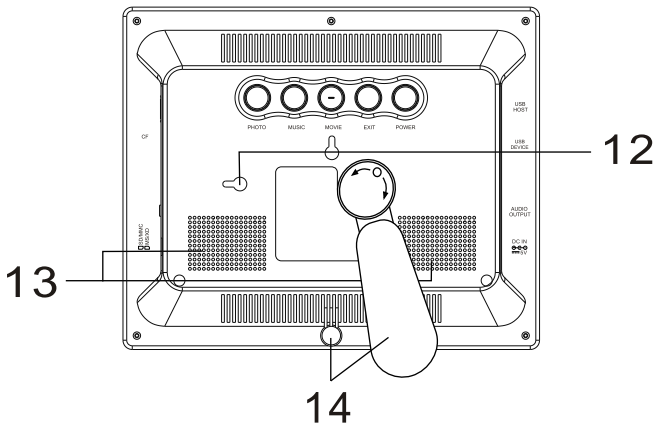

Rear side

Digital Photo Frame

Player Overview

The components may differ slightly in appearance with the provided images.

Remote Control



Power:

Press **POWER** to turn the player on and off.

16:9/4:3

Press this button to switch the ratio picture between original and optimal.

Music:

press **MUSIC** to play songs.

Slide Show:

Press **SLIDE SHOW** to continually cycle through all of the pictures in the device.

Step Show:

Press **STEP SHOW** to display a single picture; each press will advance one picture at a time.

Note: Remove Red Tab to activate battery.

Digital Photo Frame

Player Overview

Navigation Buttons:

Press the arrow keys to move the cursor to the desired icon.

Enter:

press **ENTER** to enter/confirm.

EXIT:

Press **EXIT** to stop the current action and return to previous menu.

ROTATE:

Press **ROTATE** to rotate the picture. These operations are allowed only when a picture is being displayed normally and will be cancelled automatically.

ZOOM:

Press **ZOOM** repeatedly to zoom out /in the picture.

OSD:

Press **O SD** to display the state of the playing file.

VIEW:

Press **VIEW** to view 15 pictures at a time in thumbnail size. Use the up /down/left/right buttons to select the picture and press enter to confirm .

MENU:

Press **MENU** to return to main menu.

VOL+/-:

Press the **VOLUME** button to adjust the player's volume.



Chapter 2

Connection

Power Connection	12
Connect to USB Port	13
Memory Card Insertion	14
Memory Card Extraction	15
PC Connecting	16

Digital Photo Frame

Connection

Power Connection

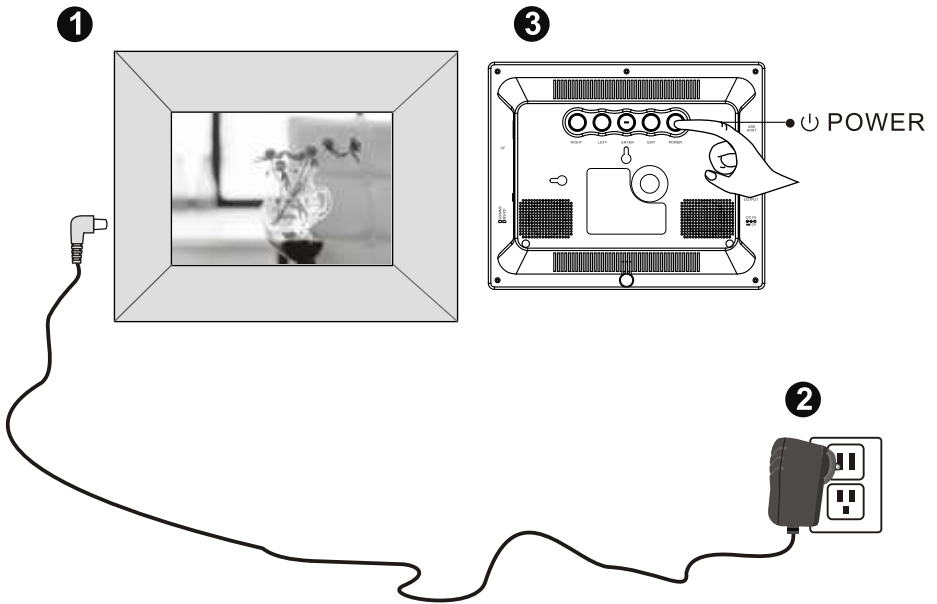

1. Connect the power adaptor to the DC 5V jack on the left side of the frame.
2. Plug in the power cord.
3. The frame will automatically power on.

Digital Photo Frame

Connection

Connect to USB Port

USB HOST: Insert various USB removable storage device as an extra source.

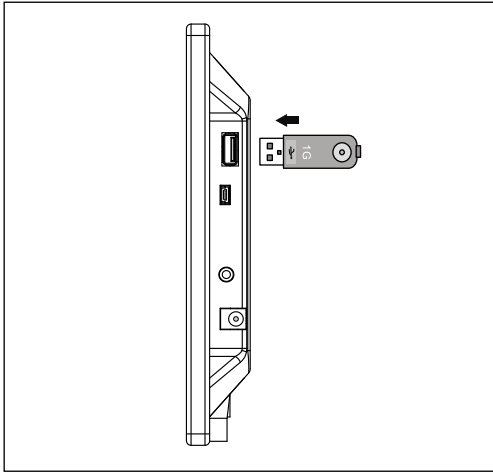

Note: USB HOST and USB DEVICE can't take effect at the same time, make sure to disconnect the DPF with your PC before inserting the USB removable storage device.

Digital Photo Frame

Connection

Memory Card insertion

When inserting a memory card into the product, refer to the image to make sure that both the memory card and product are aligned correctly. (The side of the memory card on which the sticker is affixed should face to the front)

Aligning the memory card upside down or to the reverse side may cause damage that is the sole responsibility of the user. (Use of CF ,SD, Memory Stick, MMC cards, XD card enabled)

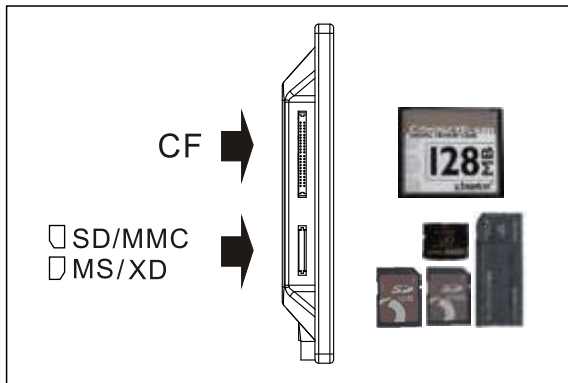

Note: MS Duo isn't compatible alone. But it can be supported with the help of MS Duo adapter.

Digital Photo Frame

Connection

Memory Card Extraction

Grip the card firmly between two fingers , and pull the card straight out without bending it. Refer to the image below:

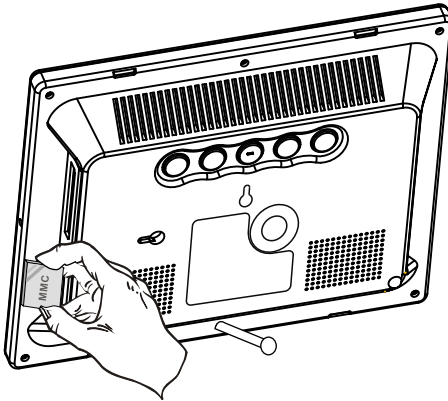

With no memory card present, the product will display images stored in the Frame's internal memory. Press MENU to return to the main menu.

Digital Photo Frame

PC Connecting

Connecting your DPF to your PC

Use the supplied USB cable to connect the DPF to your PC.

Remark : USB HOST and USB DEVICE can't take effect at the same time , make sure to remove the USB removable storage device from USB HOST before connecting the DPF to your PC .

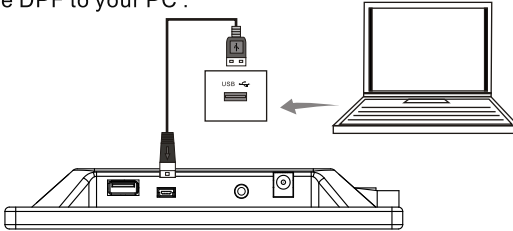

1. After connecting with the PC, the PC's screen will display as the below diagram.
2. Press "OK", then the Pc's screen will display the contents of memory. Then you can copy your required documents from your PC to your Multimedia DPF.
3. After copying the documents, close the window of the " Safely Remove Hardware" on your PC, then pull out the USB cable.
4. Then the Multimedia DPF will run normally.

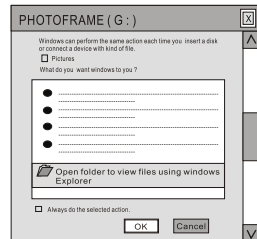

- Note:**
1. When connected to the computer ,the remote keys are inactive.
 2. While transferring documents to the DPF's Internal Memory, you have to restart the DPF to display the document you have transferred.
 3. If you want to format the diskettes, you' d better set the File System to be " FAT" or " FAT32" . Don' t set the File System to be "NTFS" , otherwise , you will fail to format the diskettes.



Chapter 3

Usage

Photo	18
Music	20
Back Music	23
Movie	24

Additional Functions	27
-----------------------------	-----------

Digital Photo Frame

Photo

Accessing Your Photo Directory

Note: Press MENU to return to the main menu.

Select the desired device and press ENTER to enter into the device menu.



Locating the four panel screen



Use the directional keys to select between Photo icon in the device menu, press ENTER to enter the four panel screen.

Note: In the four panel screen, all the directional keys are invalid.



Viewing a photo in Full Screen

In the four panel screen, press SLIDE SHOW to create a slide show of the images in full screen.

Note: To view images in split screen, there must be at least four photos on the internal memory or memory card.



Digital Photo Frame

Photo

Locating the photo browse screen

In any state, press VIEW to enter the photo browse screen directly. Use the directional keys to select the desired photo, press ENTER to display the photo in full screen. Then you can press SLIDE SHOW to create a slide show of the images.



Rotating a Photo

After selecting the desired photo, use the ROTATE button to rotate (clockwise) the photo to the desired position.



Digital Photo Frame

Music

Music

Listening to Music

Locating the Device Directory

From the main menu, select the desired device and press ENTER to enter the device menu.



Locating to the Music Directory

Use the directional keys to select MUSIC in the device menu and press ENTER.



Selecting a Music File

Use the directional keys to select the desired music file, press ENTER to play.



Digital Photo Frame

Music

Playing a song

After selecting the desired music file, press ENTER.

Adjusting the volume

During playback, press the Vol+ or Vol- buttons to adjust the volume .



NOTE: Only Mp3 format files can be played.

Digital Photo Frame

Back Music

Note: To utilize this feature you must have picture files (JPG) and music files (MP3) saved to the same file source (ie. Memory Card, USB Device or Internal Memory).

Back Music in four panel screen

1. From the main menu, select the desired device and press ENTER to enter the device menu.

2. Select PHOTO and press ENTER to enter the four panel screen, press MUSIC to start a musical slide show in four panel screen. Press ◀ or ▶ to change the song.



Back Music in full screen

1. In any state (except the photo browse screen), press SLIDE SHOW to create a slide show of the images in full screen.

2. Press MUSIC to start a musical slide show in full screen. Press ◀ or ▶ to change the song.

Note: In photo browse screen, you should double press the button SLIDE SHOW, then press MUSIC to start a musical slide show.

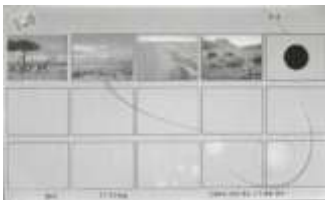

Digital Photo Frame

Movie

A variety of movie formats , including those taken with a digital camera, can be played on your frame.

Activate the Device Selection Screen

From the main menu, select the desired device and press ENTER to enter into the device menu.



Locating the Movie Directory

Use the directional keys to select MOVIE in the device menu and press ENTER to enter the movie list.



Selecting and Playing a movie

Press ▲ or ▼ to select the desired movie, press ENTER to play the movie. Press ◀ or ▶ to play the previous or the next movie.



Digital Photo Frame

Movie

Adjusting the Volume

During playback ,use the VOL(+) or VOL (-) buttons to adjust the volume.

NOTE: This frame supports the following video file types for direct playback:

- 1.MPEG-1,MPEG-4 (AVI) format files can be played.
- 2.Videos recorded on most digital cameras.



Digital Photo Frame

Additional Functions

Zoom

During photo playback, press ZOOM button to magnify the image as follows:

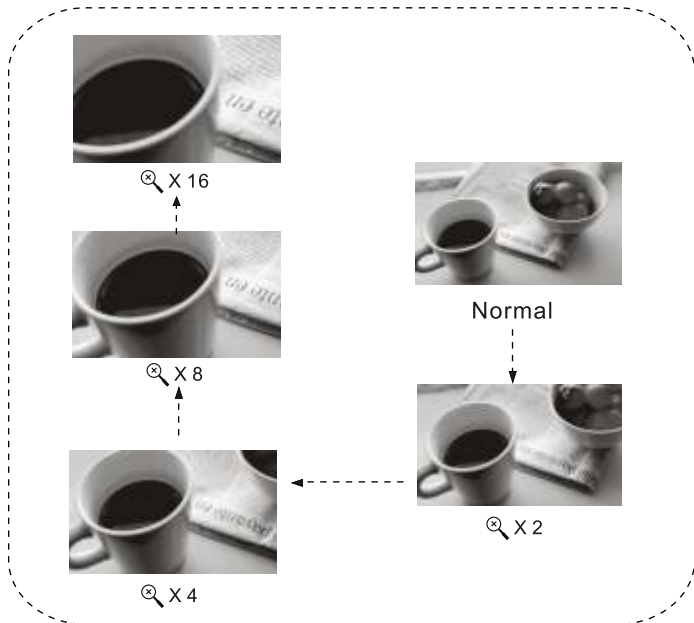
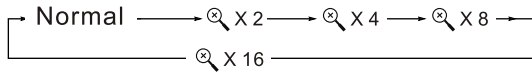

Moving the photo

After zooming the photo, you can press the directional keys to move the photo up/down/left/right optionally.

Digital Photo Frame

Additional Functions

Slide Show

In any state (except the photo browse screen) , press the SLIDE SHOW button , your frame will automatically create a slide show of the images on your internal memory

In the photo browse screen ,press SLIDE SHOW , your frame will default to display the selected photo , you should press SLIDE SHOW the second time to create a slide show of the images .

Step Show

Press the STEP SHOW button during a slide show. The slide show will pause ,displaying the image currently on the screen. Each press will advance your slide show one picture.





Chapter 4

Editing & Settings

Editing	28
Copy file	28
Delete file	30
Settings	31
Calendar	36

Digital Photo Frame

Editing Files

Editing Files

A. Copy file

From the main menu, select the desired device , press ENTER to enter the device menu . Select File and press ENTER to enter the file list .



In the file list , press ▲ or ▼ to select the file you want to copy , press ► to confirm .



Then press the OSD button , select COPY and press ENTER to display the card information , press ► to confirm .



Digital Photo Frame

Edit Files

Press ENTER to start transferring the selected file .



After the file is transferred successfully, the screen shall display as follows:



Digital Photo Frame

Edit Files

B.Delete File

For the main menu, select the desired device, press ENTER to enter the device menu. Select File and press ENTER to enter the file list.

In the file list, press ▲ or ▼ to select the file you want to delete, press ► to confirm.



Then press OSD button, select DELETE and press ENTER to confirm.



Press ENTER to start deleting the selected file.



Digital Photo Frame

Settings

Settings

Select SETTINGS in the main menu and press ENTER to enter the setup menu .

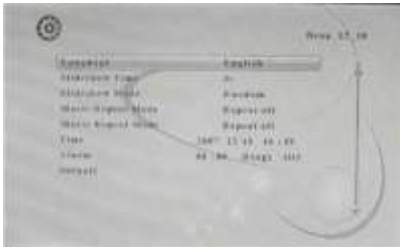

Use ▲ or ▼ to select the menu item you want to set .

Language

Then press ◀ or ▶ to select the different interface language (English/French/Deutsch/Spanish/Italian/Chinese) , press ENTER to confirm .

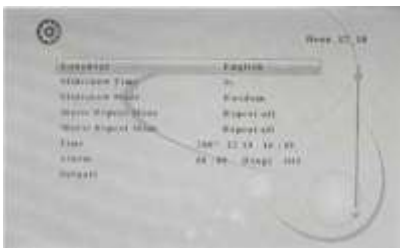

Digital Photo Frame

Settings

Slide Show Time

Press ▲ or ▼ to select Slide Show Time in the setup menu, then press ◀ or ▶ to change your selection (3s/5s/15s/1mins/15mins/1hour)



Slide Show Mode

Press ▲ or ▼ to select Slide Show Mode in the setup menu, then press ◀ or ▶ to change your selection (Off/Bottom_To_Top/Top_To_Bottom/Left_To_Right/Right_To_Left/Door_Close/Door_Open/Hori_Cross/Verti_Cross/Random/Fading/Vexpand_Top/Vexpand_Bottom/Vexpand_Middle)



Digital Photo Frame

Settings

Music Repeat mode

Press ▲ or ▼ to select Music Repeat Mode in the setup menu, then press ◀ or ▶ to change your selection (Repeat One/Repeat All/Repeat off)



Movie Repeat mode

Press ▲ or ▼ to select Movie Repeat Mode in the setup menu, then press ◀ or ▶ to change your selection (Repeat One/Repeat All/Repeat off)



Digital Photo Frame

Settings

Time

Press ▲ or ▼ to select **Time** in the setup menu.

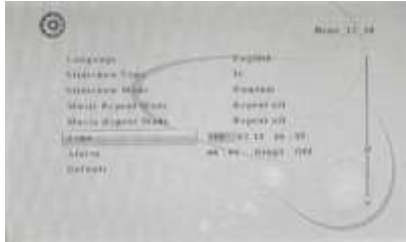

Year: use ◀/▶ to select the “year”, and use ▲/▼ to set the year.
Month: use ◀/▶ to select the “month”, and use ▲/▼ to set the month.
Date: use ◀/▶ to select the “date”, and use ▼/▲ to set the date.
Time: use ◀/▶ to select the “time”, and use ◀/▶ to select hour, minute, and use ▲/▼ to set the time. After setting please press **ENTER** to confirm.

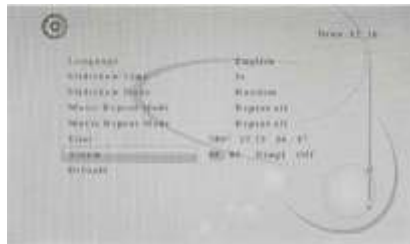

Digital Photo Frame

Settings

Default

Press ▲ or ▼ to select DEFAULT in the setup menu , press ENTER to restore to the factory default settings as follows :

A: Language is English .

B: Slideshow Time is 3s . Slideshow Mode is Random .

C: Music Repeat Mode and Move Repeat Model are Repeat all .

D: Time is 2083 02 05 09:34

E: Alarm is 00:00 Ring1 off

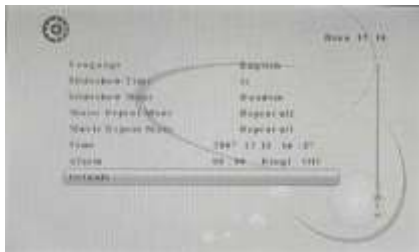

Digital Photo Frame

Calendar

In the main menu, select CALENDAR and press ENTER to display the calendar and clock.



Display Information:

- Monthly calendar display
- Picture display
- Time display
- Alarm display

Note: press EXIT to return to the main menu .

Digital Photo Frame

Auto Screen-suiting Photo Store Technology

When a PC transfers photos to the DPF with using USB connection, this function can auto-compress the photos' sizes to suit the screen's resolution, the display effect on the screen is same as the original big photo files. After the processing, the storage quantity of the photos will have a tremendous increment .

Operations Steps :

- 1.Connect your DPF to your PC, four removable disk will appear under the “My Computer” icon on the computer desktop.
- 2.From your PC, click “My Computer” to access it , select and click the disk named “memory ” and access it .
- 3.Drag the images desired to the disk named “ memory”

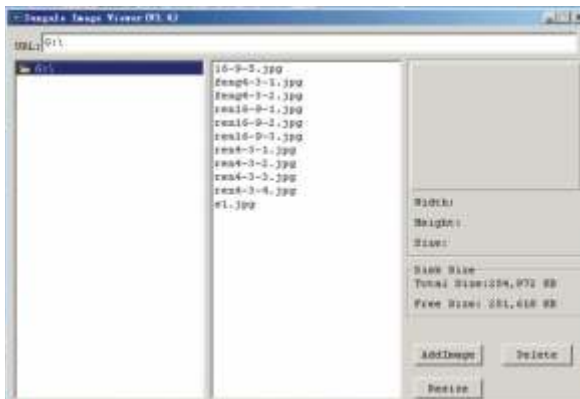

- 4.Find the tool file named “ Image Viewer.exe” and access it .
 - 5.Click “ Resize” to transform the photo’s Width and Height to the default width and height .
 - 6.You can also click “Add Image” and add the photos desired , it will automatically transform the photos to the default Width and Height .
 - 7.If you want to delete the images : Firstly ,select the photo, then click “ Delete”.
- Note : Please keep a copy of the file “ Image View .exe ” in your computer , in case the file is deleted from your DPF’s memory.



Chapter 5

Customer Management

Question & Answer	39
Troubleshooting	41
Product Specifications	42
FCC and Safety Information	43

Digital Photo Frame

Question & Answer

Q&A

This chapter will attempt to troubleshoot common problems that one may experience with the Multimedia DPF. If this guide can not solve your problem. Do not dismantle the machine yourself.

Question	Answer
What photo, music, and video formats are supported by the Multimedia Digital Photo Frame?	Photo: JPEG Music: MP3 Video: MPEG-I, MPEG-4(avi, divx or xvid format)
What memory cards are compatible with the digital frame?	Secure Digital Card (SD)/MultiMedia Card (MMC) Memory Stick, CF(Type I, Type II), XD, Memory stick Pro.
How do I store music files?	Use a personal computer and a popular audio editing software such as Music Match to convert your music to MP3 format. Transfer the MP3 file to the memory card by using a Memory Card Reader. Transfer the Mp3 files from pc or USB directly.
Does Multimedia Digital Photo Frame have built-in memory?	Yes. The player has an internal memory to store media file. Its memory volume is 128MB. Do not rename the memory's name.
Can I insert multiple memory cards?	Yes, you can insert one CF card with one of SD, MMC, MS, MS Pro, XD at the same time.
Does it play every type of AVI video file?	No. The device only works with the AVI files taken by most digital cameras.
What is the best picture resolution displayed on the screen?	The player's best resolution is 800(RGB) x 600.
Can I rotate a picture on the screen?	Yes. Use the ROTATE buttons on the remote control to rotate a picture. Note: The rotated picture will return to its original orientation after you power off the digital frame.
Why Digital picture Frame does not advance to next picture?	1. There is only one picture in the frame. 2. You are viewing high-resolution pictures on the card, High-resolution pictures can take some to display. 3. You are in still display mode. 4. The next picture is damaged.

Digital Photo Frame

Question & Answer

Can I adjust the colors of the picture?	You can adjust the picture display in the video settings in the set up menu. You can also adjust the brightness and contrast, however, this will not alter the contents of your pictures files.
Why can't my PC find the internal memory?	Turn on the multimedia digital photo frame and wait for the function menu to appear, then connect the USB cable from the unit to PC, If the found new device prompt does not appear on your computer screen, look in "my computer" for a USB mass storage device.
Why the unit can't play pictures?	1.Ensure the pictures are stored in the card or USB. 2.The unit only recognizes pictures stored in JPEG, JPG format. 3. If can not play the pictures, please format your card / internal memory
What MPEG-4 formats are supported by the multimedia digital photo frame?	The player can support AVI, DIVX and XVID video file.
Why won't my multimedia digital photo frame play my downloaded music?	The player can only play mp3
Why doesn't the photo cover the entire screen?	The resolution required for a picture to cover the entire screen must be greater than 800 X 600 pixels.
Can the DPF player connect with all computers?	No,the USB port of the PC connected with the player must be USB 2.0, and the PC must be windows system (eg.windows 2000, windowsXP.etc).

Digital Photo Frame

Troubleshooting

If you have any questions, please consult the troubleshooting guide below. Some simple checks or a minor adjustment on your part may eliminate the problem.

No power

- Ensure the power button is on
- Ensure the power cord is not damaged
- Ensure the power plug is connected firmly to the outlet

Could not read the card

1. Please copy the content in your card to your PC, then format your card, then pass your photos/music/movies in your card again, then insert the card to DPF .
2. Ensure the card is not damaged
3. Ensure the card is connected to the DPF correctly
4. Ensure the card has content(photo/ music/movie), if no content in card, the screen will display "Files can't be found"

Remote control not working

1. Ensure the batteries are inserted
2. Ensure the batteries "protective plastic" is pulled out.

Digital Photo Frame

Product Specifications

Specifications can be changed without prior notice in the interest of improving product performance.

Product Specifications

Item		Details
LCD Display	Size	8 Inch (Diagonal)
	Resolution	800(Horizontal)*600(Vertical)
	Brightness	300cd /m²
	Contrast Ratio	350:1
Memory	Internal Memory	128MB
	Compatible Memory Cards	CF / SD / MMC / Memory Stick / XD
Remote Control		27Keys
Support Media Formats	Images	JPEG(jpg)
	Video	MOVIE
	Audio	MUSIC
Internal Speaker	Stereo	1W*2, 400HZ~20KHZ
Power	Adapter	Input: 100~240V AC, Output: 5V, 2A DC
	Electricity Consumption	7.2W (Operating)
Size	Width*Height*Depth	220(w)*180(h)*30(d)[mm]
Weight	Kg	1.2
USB Connection	USB Host	USB 2.0(USB Memory)

Digital Photo Frame

FCC and Safety Information

• FCC Part 15.19

This device complies with Part 15 of the FCC Rules .Operation is subject to the following two conditions: (1) this device may not cause harmful interference , and (2) this device must accept any interference received ,including interference that may cause undesired operation .

• FCC part 15.21

Warning: Changes or modifications to this unit not expressly approved by the party responsible for compliance could void the user’ s authority to operate the equipment.

• FCC part 15.105

Note : This equipment has been tested and found to comply with the limits for a Class B digital device ,pursuant to Part 15 of the FCC Rules, These limits are designed to provide reasonable protection against harmful interference in a residential installation .This equipment generates, uses, and can radiate radio frequency energy and ,if not installed and used in accordance with the instructions, may cause harmful interference will not occur in a particular installation . If this equipment does cause harmful interference to ause harmful interference to radio or television reception ,which can be determined by turning the equipment off and on ,the user is encouraged to correct the interference by one or more of the following measures:

- Reorient or relocate the receiving antenna.
- Increase the separation between the equipment and receiver.
- Connect the equipment into an outlet on circuit different form that to which the receive is connected.
- Consult the dealer or an experienced radio TV technician for help.

LIMITED WARRANTY

The limited warranty set forth below is given by Sungale Group Inc. ("SGI") with respect to Sungale brand DPF players and other consumer electronics products purchased and used in the United States of America. SGI warrants this product against defects in material or workmanship as follows:

LABOR: For a period of ninety (90) days from the date of purchase, if this Product is defective, SGI will repair or replace the Product, at its option, at no charge. After this ninety (90) days period up to one year, a labor charge of US\$30.00 will be charged for each service.

PARTS: For a period of one year from the date of purchase, SGI will supply, at no charge, new or rebuilt replacement parts in exchange for defective parts. After this one year period, SGI will charge the new or replacement parts.

This warranty does not cover: (1) customer instruction, installation or set up; (2) cosmetic damage or damage due to accident, misuse, abuse, or negligence; (3) commercial use of the Product; (4) modification of any part of the Product; (5) damage due to improper operation, improper maintenance, or connection to an improper voltage supply; (6) damage due to an attempted repair of the Product by anyone other than a facility authorized by SGI to service the Product; (7) consumables (such as fuses and batteries). This warranty is valid only in the United States.

The product must be accompanied by a copy of the original retail purchase receipt. If no proof of purchase is attached, the warranty will not be honored and repair cost will be charged.

This warranty is valid with attach written documentation detailing the complaint to the outside or inside of the carton.

This warranty is invalid if the factory applied serial number has been altered or removed from the Product.

SGI reserves the right to modify any design of this product without prior notice.

To obtain warranty service, you must deliver the product freight prepaid, in either its original packaging or packaging affording an equal degree of protection, plus proof of purchase, to:

Service Center
13358 Monte Vista Avenue,
Chino, CA 91710
Tel: **800-473-5156**

REPAIR OR REPLACEMENT AS PROVIDED UNDER THIS WARRANTY IS THE EXCLUSIVE REMEDY OF THE CONSUMER. SGI SHALL NOT BE LIABLE FOR ANY INCIDENTAL OR CONSEQUENTIAL DAMAGES FOR BREACH OF ANY EXPRESS OR IMPLIED WARRANTY ON THIS PRODUCT. EXCEPT TO THE EXTENT PROHIBITED BY APPLICABLE LAW, ANY IMPLIED WARRANTY OF MERCHANTABILITY OR FITNESS FOR A PARTICULAR PURPOSE ON THIS PRODUCT IS LIMITED IN DURATION TO THE DURATION OF THIS WARRANTY.

Some states do not allow the exclusion or limitation of incidental or consequential damages, or allow limitations on how long an implied warranty lasts, so the above limitations or exclusions may not apply to you. This warranty gives you specific legal rights, and you may have other rights which vary from state to state.

Digital Photo Frame

Sungale

Free Manuals Download Website

<http://myh66.com>

<http://usermanuals.us>

<http://www.somanuals.com>

<http://www.4manuals.cc>

<http://www.manual-lib.com>

<http://www.404manual.com>

<http://www.luxmanual.com>

<http://aubethermostatmanual.com>

Golf course search by state

<http://golfingnear.com>

Email search by domain

<http://emailbydomain.com>

Auto manuals search

<http://auto.somanuals.com>

TV manuals search

<http://tv.somanuals.com>