

15

*Digital Photo Frame  
User's Manual*

AW15S-B

**Sungale**

# Contents

## User Notice

---

This product has met all electronic emission standards. This product may be used safely in the home.



## Chapter 1 Introduction

---

Product Introduction	3
Safely Precautions	4
Components	6
Product Map	7

## Chapter 2 Connection

---

Connecting to a power source	12
Memory Cards	15
Connecting to a PC	16

## Chapter 3 Usage

---

Photos	18
Music	20
Background Music	23
Movies	24
E-BOOK	26
Additional Features	27

## Chapter 4 - File Management and Settings

---

Editing	30
Settings	33

## Chapter 5 - Customer Service

---

Frequently Asked Questions	40
Troubleshooting	42
Product Specifications	43
FCC and Safety Information	44



## Chapter 1

# Introduction

---

<b>Product Introduction</b>	<b>3</b>
<b>Precautions</b>	<b>4</b>
Electrical Safety	4
Handling	5
<b>Components</b>	<b>6</b>
Basic Components	6
<b>Player Overview</b>	<b>7</b>
Digital Frame	7
Remote Control	9

# Digital Photo Frame

## Product Introduction

---

The **Bluetooth** Digital Photo Frame is a convenient image album that keeps your favorite images at your fingertips.

With its bright and vivid LCD screen, this **Bluetooth** Digital Photo Frame offers an alternative to photo printing, adding a new level of convenience to your life.

With its diverse file management functions, this **Bluetooth** Digital Photo Frame allows you to relive your cherished memories anytime.

# Digital Photo Frame

## Safety Precautions

Please read the following guidelines carefully to ensure user safety.

### Power Related

**⚠ WARNING:** indicates information that, if neglected, could result in serious injury and/or death to the user.

**⚠ CAUTION:** indicates information that, if neglected, could result injury to the user and/or material damage.

01. Use only the power supply included with your frame. Failure to do so may result in product malfunction.

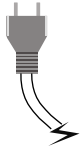

02. When connecting to your power source, make sure that your hands and feet are free of moisture. Failure to do so could result in electrical shock.

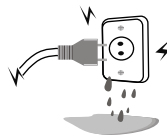

03. Make sure the power supply is firmly plugged in. A loose power cord could result in shock, or fire.

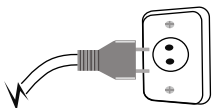

04. Do not let the power cord get tangled, and do not place heavy objects on the cord. Putting stress to the cord creates a fire hazard and the possibility of electric shock.

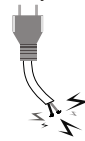

05. Do not overload power strips.

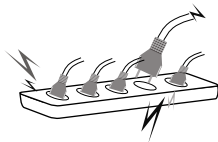

06. Disconnect the power supply during incremental weather conditions including lightning storms. Failure to do so may result in fire.



# Digital Photo Frame

## Safety Precautions

Please adhere to the following guidelines to ensure user safety, and avoid product malfunction.

### Product Related

01. Dropping the product or subjecting it to a significant impact can cause critical damage.

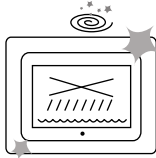

02. Spilling water or any other liquid on the product can cause critical damage.



03. Striking or scratching the LCD screen may cause permanent damage to the screen.

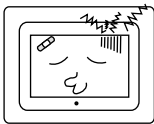

04. When cleaning the LCD screen, turn off the power and wipe it gently with a soft cloth.

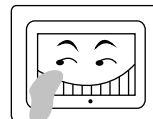

05. Do not subject the product to severe humidity and/or heat.

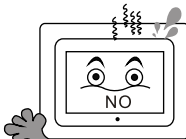

06. Make sure to power off the unit before disconnecting the power supply.

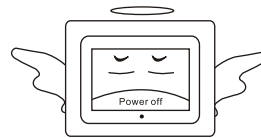

# Digital Photo Frame

## Components

---

Because Sungale is constantly working to improve its products, basic components may be modified without prior notice and may differ in appearance with the images below.

### Basic Components

These components are provided with your product purchase.

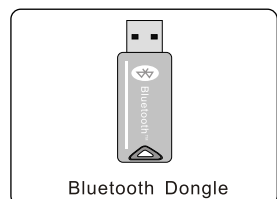
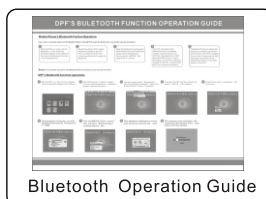
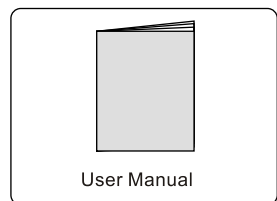
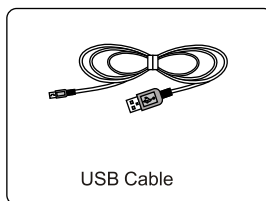
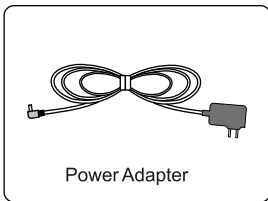
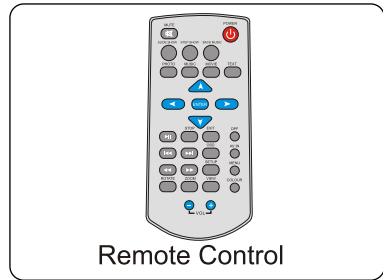
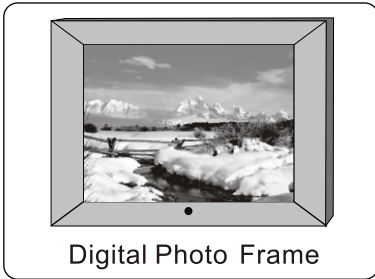

# Digital Photo Frame

## Player Overview

Your frame may differ slightly in appearance with the images provided.

### Digital Frame

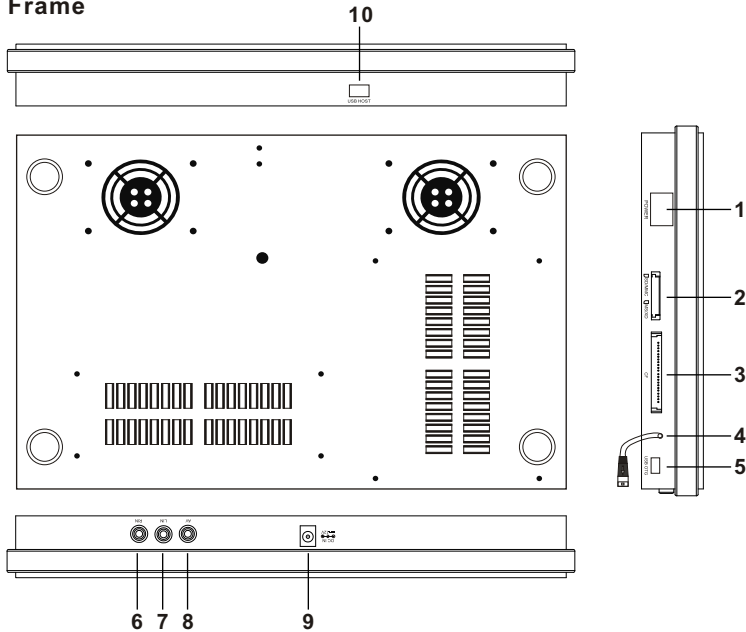

1. POWER: Turns the player off and on.
2. MS/SD/MMS/MS Pro/XD CARD SLOT: Insert supported memory card types here.
3. CF CARD SLOT: Insert CF card here.
4. USB HOST CABLE: Connect USB OTG to enable use of the USB HOST.
5. USB OTG: This port allows USB connection between Frame and PC.
6. RIN: Right audio input
7. LIN: Left audio input.
8. AV: Video input
9. DCIN: Insert the DC power adaptor to your Digital Photo Frame.
10. USB HOST: Connect the Bluetooth Dongle/ USB removable storage device /MP3/PMP/Mobile hard disk to your Digital Photo Frame. (Before doing this, be sure to connect the attached USB HOST CABLE to the USB OTG.



# Digital Photo Frame

## Player Overview - Frame

---

Your Frame may differ slightly with the images below.

### Rear View

- 12. Wall mount
- 13. Speaker: Built in stereo speakers.

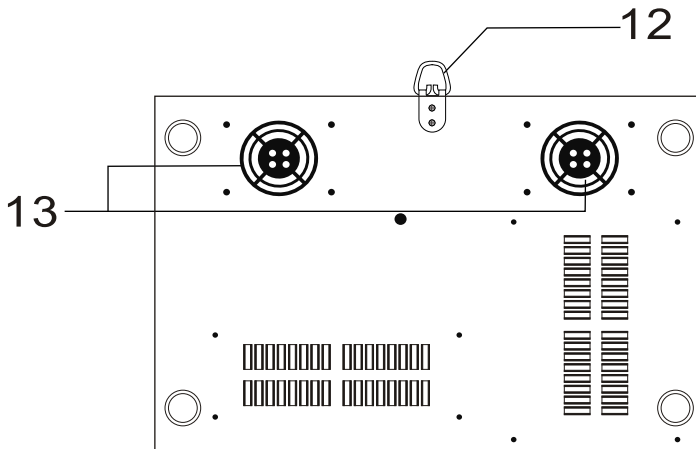

**Rear side**

# Digital Photo Frame

## Player Overview - Remote Control

Your remote control may differ slightly in appearance with the images provided.

### Remote Control



#### **Power:**

Press **POWER** to turn the player on and off.

#### **Mute:**

Press **MUTE** to toggle sound on and off.

#### **Photo:**

Press **PHOTO** to start a slideshow.

#### **Music:**

Press **MUSIC** to play songs.

#### **Movie:**

Press **MOVIE** to play movies.

#### **Text:**

Press **TEXT** to open text files.

#### **AV IN**

Press **AV IN** to switch to AV input mode.

**Note:** Remove Red Tab to activate battery.

# Digital Photo Frame

## Player Overview

---

### **ROTATE:**

Press **ROTATE** to rotate the picture. (Note: this does not permanently change the picture's orientation)

### **ZOOM:**

Press **ZOOM** repeatedly to zoom in/out on your pictures.

### **VIEW:**

Press **VIEW** to view 9 pictures at a time in thumbnail size. Use the up/down/left/right buttons to select the picture and press enter to confirm.

### **OSD:**

Press **OSD** to display the state of the file being played. In edit mode, use OSD to execute copy/paste/delete functions (see page 30).

### **Menu:**

Press **MENU** to return to the main menu.

### **BACK MUSIC:**

Press **BACK MUSIC** to play a picture slideshow with background music.

### **SLIDE SHOW:**

Press **SLIDE SHOW** to display a continuous cycle of all images in the internal memory.

### **STEP SHOW:**

Press **STEP SHOW** to display a single picture. Press it again to advance to the next image.

### **DPF:**

Press **DPF** to switch to the **DPF** interface.

### **COLOUR:**

Press **COLOUR** to switch between soft/nature/bright/user style set up.

### **EXIT:**

Press **EXIT** to stop the current action and return to the previous menu.

### **PLAY/PAUSE:**

Press to **PLAY** or **PAUSE** a file.

### **SETUP:**

Press **SETUP** to set the language/picture/version settings.

### **STOP:**

Press to **STOP** picture playback and return to the file list.

### **PREV:**

Press **PREV** to skip to the previous title/chapter/track/picture.

### **NEXT:**

Press **NEXT** to skip to the next title/chapter/track/picture.

### **VOL +/-:**

Press the **VOLUME** buttons to adjust the players volume for MP3 and movie playback.



**Chapter 2**

**Connection**

Power Connection	12
Connect to USB Port	13
Memory Card Insertion	14
Memory Card Extraction	15
PC Connecting	16

# Digital Photo Frame

## Connection

---

### Power Connection

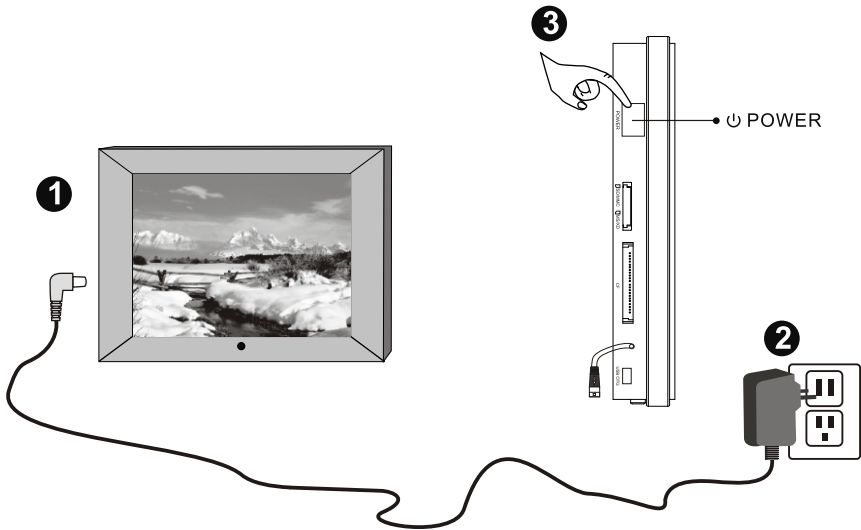

1. Connect the power adaptor to the DC 12Vin Jack on the left side of the frame.
2. Plug the power cable into a wall outlet.
3. The player will power on automatically.

# Digital Photo Frame

## Connection

---

### Connect to USB HOST

USB HOST: Insert one of the listed USB removable storage devices or the Bluetooth Dongle to the USB HOST jack. Do not force the device in; check to make sure the orientation of the device is correct.

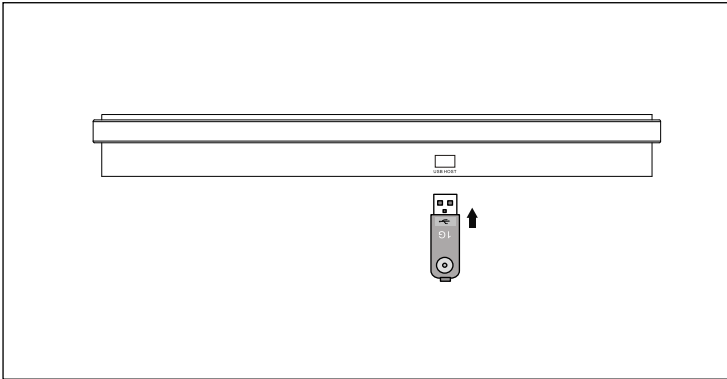

**Note:** Before connecting the USB removable storage device or Bluetooth Dongle to the DPF, make sure to attach the USB HOST CABLE to the USB OTG port.

# Digital Photo Frame

## Connection

---

### Inserting Your Memory Card

Refer to the picture below to make sure that the memory card is correctly aligned with the frame. The rule of thumb is that the sticker side of the memory card should face the front.

Incorrect alignment of the memory card upon insertion may cause damage to the unit and/or the card.

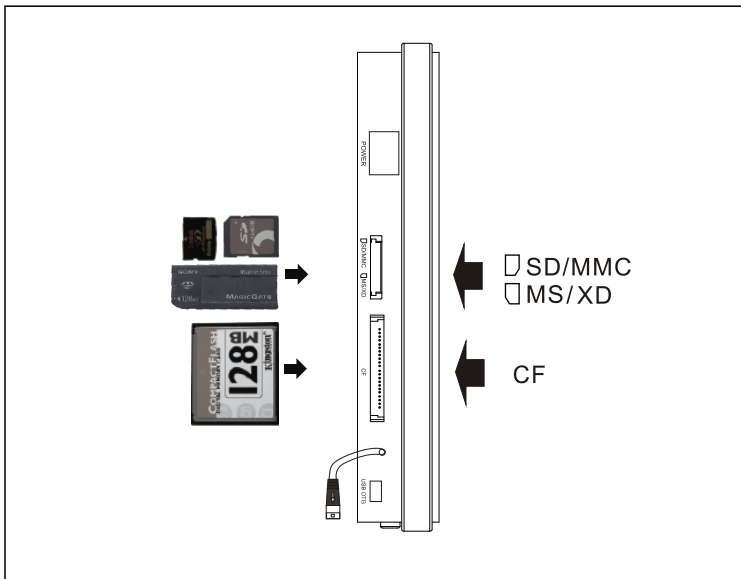

# Digital Photo Frame

## Connection

---

### Removing Your Memory Card

Grip the card firmly between two fingers, and pull the card straight out without bending it. Refer to the image below:

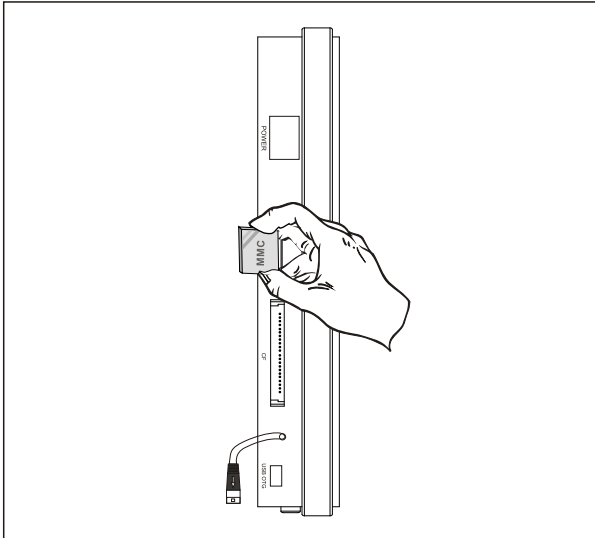

Note: With no memory card present, the product will display images stored in the Frame's internal memory. Press MENU to return to the main menu.



# Digital Photo Frame

## PC Connecting

### Connecting your DPF to your PC

Use the supplied USB cable to connect your DPF to your PC.

Note: Before connecting to your PC, first unplug the attached USB HOST CABLE from the USB OTG jack.

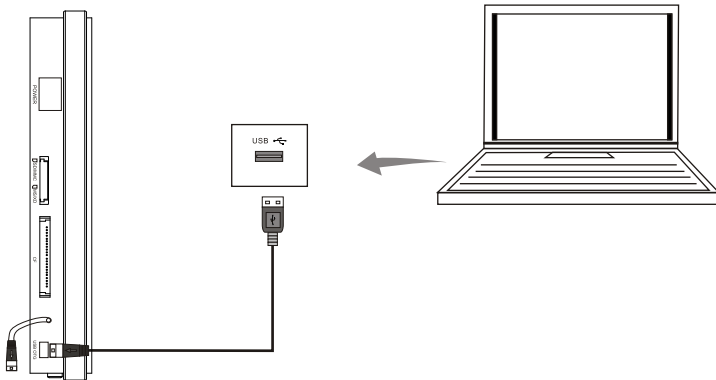

1. After connecting your DPF to the PC, your PC should display a window similar to the one shown below.
2. Choose "Open folder to view files..." and click "OK". Your PC will display the contents of your memory.
3. With your DPF files on display, you may copy documents and move them to your PC, delete items from your DPF's memory, or paste files on your PC into your DPF's memory. Right click the desired items to find these options.
4. When you are finished managing your files, click the "Safely Remove Hardware" icon on your toolbar and confirm the operation.
5. When your PC says you may remove your hardware, unplug the USB cable from your PC, and resume use of your DPF.

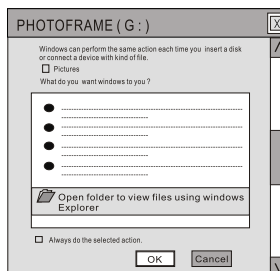



**Chapter 3**

**Usage**

---

<b>Photos</b>	<b>18</b>
<b>Music</b>	<b>20</b>
<b>Background Music</b>	<b>23</b>
<b>Movies</b>	<b>24</b>
<b>E- Book</b>	<b>26</b>
<b>Additional Functions</b>	<b>27</b>

# Digital Photo Frame

## Photos

### Accessing Your Photo Directory

**Note :** Press MENU at any time to return to the MAIN MENU.

Press PHOTO then ENTER to enter the device selection screen.

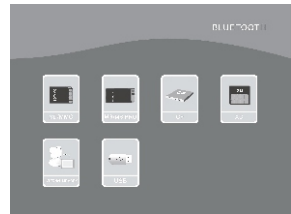
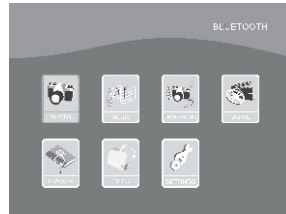

### Selecting a Device

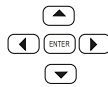

Use your directional buttons to select the desired device and press ENTER to enter the file display screen.

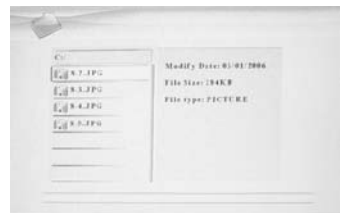
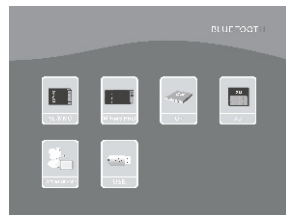
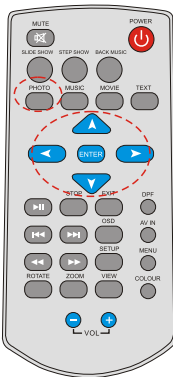

### Viewing a Photo in Full Screen

Press "right" or ENTER to enter your file list. Press "up" or "down" to select a picture, and press ENTER to view it.

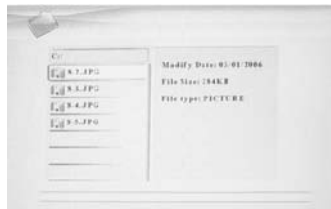

# Digital Photo Frame

## Photo

### Rotating a Photo

After selecting the desired photo, press **ROTATE** to rotate the photo clockwise.

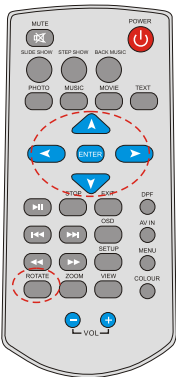

# Digital Photo Frame

## Music

---

### Music

#### Listening to Music

##### Locate the Device Directory

From the main menu, select MUSIC and press ENTER.

##### Locate the Music Directory

 Use the directional keys to select the desired memory device and press ENTER.



##### Selecting a Music File

 Use the directional keys to select the desired music file. Press ENTER to play.

# Digital Photo Frame

## Music

---

### Play a Song

After selecting the desired music file, press the PLAY/PAUSE button.

### Pausing Music

During playback, press the PLAY/PAUSE button.



# Digital Photo Frame

## Music

---

### Adjusting the volume

During playback, use the VOL+ and VOL- buttons to adjust the volume.

### Muting the Sound

During playback, press the MUTE button.



**NOTE:** Only MP3 and WMA formatted sound files can be played.

# Digital Photo Frame

## Back Music

**Note:** To utilize this feature you must have picture files (JPG) and music files (MP3 or WMA) saved to the same file source (ie. Memory Card, USB Device or Internal Memory).

1. From the Main Menu use the navigational buttons to select PHOTO/MUSIC and press ENTER

2. Use the arrow keys to select the file source where your music and pictures are stored. Press ENTER to confirm and press "right" to enter the file list. The screen will display as shown on the left.

3. Use the "up" or "down" keys to select a picture or song in the filelist and press ENTER to play the a musical slideshow starting with that file. You may also press BACKMUSIC to go directly to a musical slideshow beginning with the first image and first song on your list.

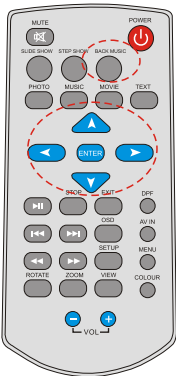

**Note:** During playback press OSD for additional options: Play, Pause, Stop, Previous (goes to previous picture), Next (advances to next picture), Fast Forward (advances the music), Fast Backwards, Show file info, ID3 tag display, Play Mode. Use "left"/"right" keys to select these options.



# Digital Photo Frame

## Movie

A variety of movie formats, including those taken with a digital camera, can be played on your frame.

### Activate the Device Selection Screen

From the Main Menu select MOVIE and press ENTER to enter the device selection screen.

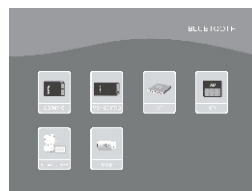
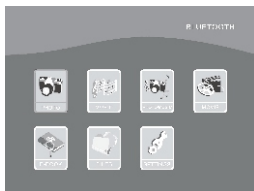

### Select the Appropriate Source

Use the directional keys to select the memory source with your movies, and press ENTER.

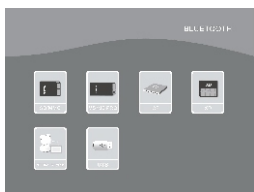
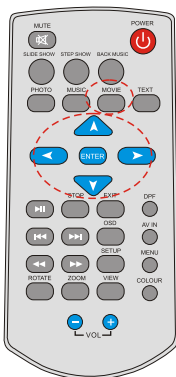

### Selecting and Playing Movies

Use the directional keys to select the desired movie and press ENTER or PLAY/PAUSE to play the movie file.



# Digital Photo Frame

## Movies

### Adjusting the Volume

During playback, use the VOL+ and VOL- buttons to adjust the volume.

### Muting the Sound

During playback, press the MUTE button to mute the sound. Press it again to play sound.



**NOTE:** This frame supports the following video file types for playback:

1. MPEG-1, MPEG-4 (AVI formats not available).
2. Videos recorded on most digital cameras.

# Digital Photo Frame

## E- Book

---

**Note:** This Frame is only compatible with TXT formatted text.

Select the E-BOOK icon from the main menu and press ENTER to activate the device selection screen. Use the directional buttons to select the device you have stored your TXT documents in. Press ENTER and then press "right" to enter the file list. You will arrive at the following screen:



While viewing your document:

1. Press "left" to go to the previous page.
2. Press "right" to advance to the next page.
3. Press "up" to go to the line above.
4. Press "down" to advance to the next line.

Use "up" and "down" to select a document. Press ENTER to view the selected document.

# Digital Photo Frame

## Additional Functions

### Zoom

During photo playback, pressing ZOOM repeatedly will magnify the image in the following cycle:

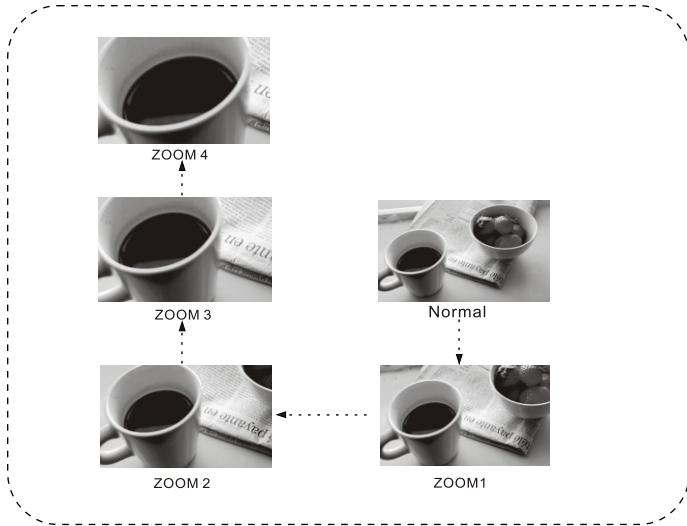
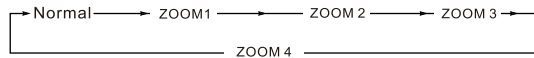

### SLIDE SHOW

Press the **SLIDE SHOW** button.

Your Frame will automatically create a slide show of the images on your internal memory.

### STEP SHOW

Press the **STEP SHOW** button during a slide show. The slide show will pause, displaying the image currently on the screen. Each press will advance your slide show one picture.

# Digital Photo Frame

## Additional Functions

### BACKGROUND MUSIC

Press the **BACK MUSIC** button to begin a slideshow with music in the background.

**Note:** Music must be in MP3 or WMA format.

### SETUP

In the Main Menu use the navigation buttons on the remote control to select the **SETTINGS** icon and press **ENTER**.

Setup: Refer to page 33-38 for instructions on changing your settings.

Setup Initialize: Returns settings to default.

Internal Memory: Performs a quick format check.



### AV IN

Press **AV IN** to switch the player to AV input mode. Your DPF will now receive its audio/video signal through its AV IN jacks.

### COLOUR

Press **COLOUR** to select a color setting from the following options: bright, soft, user, nature.



**Chapter 4**

## **Editing & Settings**

<b>Editing</b>	<b>30</b>
Copy file	30
Delete file	32
<b>Settings</b>	<b>33</b>
Language set	33
Picture set	34
Start up set	36
Video set	37
Default set	37
Version	38

# Digital Photo Frame

## Editing Files

### Editing Files

From the main menu, use the arrow buttons to select the FILE icon in the main menu. Press ENTER to enter the card selection screen. Select the desired memory card and press ENTER to enter the file list.



### A. Copy and Paste a File

Use "up" or "down" to locate and highlight the file you wish to copy. Press RIGHT to select the file.



Press EXIT to re-enter the card selection screen then select INTERNAL MEMORY. Press the OSD button and ENTER to display the conte



# Digital Photo Frame

## Editing Files

---

Using the arrow keys, select COPY/PASTE and press ENTER To start transferring the file. If you are succesfful the screen will display as follows:

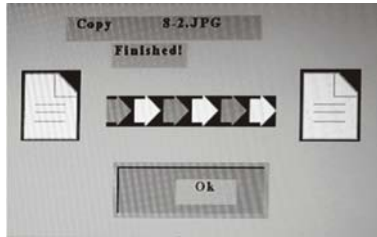



# Digital Photo Frame

## Editing Files

### B. Delete Files

From the file view screen use "up" or "down" to locate the file you want to delete and press the **RIGHT** arrow key. Press **OSD**:



Select **DELETE** from the list of options and press **ENTER**. Upon a successful delete you will receive a "Finished!" message as follows:

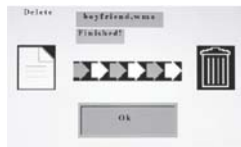

### C. EXIT

When you wish to leave the **EDIT** interface, press **EXIT** to return to the main menu.

# Digital Photo Frame

## Settings

---

### Settings

Use the navigation buttons on the remote control to select the SETTINGS icon and press ENTER.



Use "up" or "down" to choose which setting you wish to change.

### Language Settings

Select LANGUAGE SET in the SETTINGS menu, and press "right" to display a submenu.



Use "up" or "down" to change your selection

This DPF supports Chinese/English OSD settings.

- A. Press ENTER to confirm.
- B. Press "left" to return to the higher menu.

# Digital Photo Frame

## Settings

### Picture Settings

Select **PICTURE SET** in the Settings Menu, and press "right" right to access the submenu:



Press "up" or "down" to select slideshow mode or picture play mode.

1. Select Slide show mode in the **SETTINGS** menu and press "right" to access the submenu:



Press "up" or "down" to choose between 5sec, 10sec, 30sec, 60sec, or 1 hour.

Press **ENTER** to confirm or press "left" to return to the higher menu.

# Digital Photo Frame

## Settings

2. Select picture play mode in the SETTINGS menu, and press ► to display the [Picture play mode] submenu:

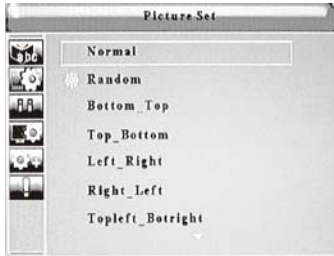

Press ▲ or ▼ to change your selection (Normal/Random /Bottom\_Top/Top\_Bottom /Left\_Right/ Right\_Left / Topleft\_Botright)

- A. Press **ENTER** to set
- B. Press ◀ to return the upper menu.

# Digital Photo Frame

## Settings

### Startup setting

Select **STARTUP SET** in the Settings menu, and press "left" to access the submenu:



Press the navigation keys to change the DPF's startup mode. Doing this configures your Frame to start in Picture, Music, or Movie mode.

For example, if you want music to play upon powering up your DPF, use the arrow keys to select **MUSIC** and press **ENTER** to confirm.



# Digital Photo Frame

## Settings

### Video Setup

Select **VIDEO SET** in the Settings menu and press "right" to access the submenu:

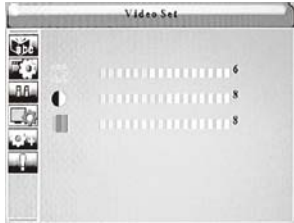

Press ▲ or ▼ to change your selection

You can set the **Lightness/Contrast/Color** levels 0-16.

- A. Press "left"/"right" to set and press **ENTER** To confirm.
- B. Press "left" to return to the higher menu.

### Default Set

This function restores the factory default settings as follows:



# Digital Photo Frame

## Settings

---

### Version



Select **VERSION** in the Settings menu to see your player's Version number. Press **EXIT** to exit the Settings menu.



**Chapter 5**

**Customer Management**

Question & Answer	40
Troubleshooting	42
Product Specifications	43
FCC and Safety Information	44



# Digital Photo Frame

## Question and Answer

---

### Q&A

This section will attempt to troubleshoot common problems that one may experience with the Multimedia DPF. If this guide does not solve your problems, do not dismantle the machine yourself.

Question	Answer
What photo, music, and video formats are supported by this Multimedia Digital Photo Frame?	Photo: JPEG, BMP(24bit) Music: MP3, WMA Video: MPEG-I, MPEG-4(avi, divx or xvid format)
What memory cards are compatible with this frame?	Secure Digital Card (SD)/MultiMedia Card (MMC) Memory Stick, CF(Type I ), XD, Memory stick Pro.
How do I obtain the right music format?	Yes, the player has 512MB of internal memory to store your files. Do not rename the memory folder in your PC.
Does this Frame have built-in memory?	Yes, you can insert a CF card and a SD, MMC, MS, MS Pro or XD card into the other slot at the same time.
Can I insert multiple memory cards?	No, but the device will work with AVI files taken with most digital cameras.
Does this frame play all AVI video files?	The frame's best resolution for images is 1280x800(RGB).
What is the best picture resolution displayed on the screen?	The frame can only play TXT files written in English or Chinese.
Why won't the player show my document files?	Yes. Use the ROTATE button to rotate a picture.
Can I rotate a picture?	Note: the rotated picture will return to its original orientation upon powering off the unit. Use photo-editing software to permanently adjust your pictures.
Why won't my frame advance to the next picture?	1. There may be only one picture in the memory. 2. You may be viewing a high resolution image which takes longer to load. 3. You are in Display mode. 4. The next picture is a corrupted file.

# Digital Photo Frame

## Question and Answer

---

Can I adjust the colors of the display?	You can adjust the picture display in the video settings in the set up menu by changing the brightness and contrast settings. This will not alter the contents of your picture files.
Why can't my PC find the internal memory?	Turn on the DPF and wait for the function menu to appear, then connect the USB cable from the unit to PC. If the "Found New Hardware" prompt fails to appear, look in "My Computer" for a USB mass storage device.
Why won't the unit play pictures?	<ol style="list-style-type: none"><li>1. Ensure the pictures are stored in the card or USB drive, and that you have the correct source selected.</li><li>2. Make sure all your image files are JPEG, JPG or BMP format.</li><li>3. If pictures still do not play, try reformatting your card or internal memory.</li></ol>
What MPEG-4 formats are supported by the multimedia Digital Photo Frame?	The player can support most AVI, DIVX and XVID video files.
Why won't the frame play my music?	The player can only play MP3 and WMA audio files (bit rate 32kbps- 192kbps).
Why doesn't the photo cover the entire screen?	The resolution required for a picture to cover the entire screen must be greater than or equal to 1280x800 pixels (RGB).
Can the DPF connect with ALL computers?	No. The PC must have a USB 2.0 or higher, and the PC must have Windows 2000 or above.

# Digital Photo Frame

## Troubleshooting

---

Consult the troubleshooting guide below if you are experiencing any problems with the unit. A minor adjustment may eliminate the problem.

No Power

Press and hold the power button  
Ensure the power cord is not damaged  
Ensure the power plug is connected firmly to a working outlet.

Cannot read WMA music:

This unit only supports WMA with bit rate: 32Kbps - 192kbps

Cannot read card.

1. Please copy the content of your card to your PC, then format your card. Repaste the photos/music/movies onto your card, and then reinsert the card into your DPF.
2. Ensure the card is not damaged.
3. Ensure the card is correctly and firmly connected to the DPF.
4. Ensure the card has content (photos, music, or movies). If there is no content on the card, the screen will display "Files can't be found"

Remote control not working

1. Ensure the batteries are inserted
2. Ensure the batteries' protective plastic tab is pulled out.

# Digital Photo Frame

## Product Specifications

Specifications can be changed without prior notice in the interest of improving product performance.

### Product Specifications

Item		Details
<b>LCD Display</b>	<b>Size</b>	<b>14 Inch (Diagonal)</b>
	<b>Resolution</b>	<b>1280(Horizontal)*800(Vertical)</b>
	<b>Brightness</b>	<b>350cd /m<sup>2</sup></b>
	<b>Contrast Ratio</b>	<b>400:1</b>
Memory	Internal Memory	512MB
	Compatible Memory Cards	CF / SD / MMC / Memory Stick / XD
<b>Remote Control</b>		<b>28Keys</b>
Support Media Formats	Images	JPEG(jpg)/BMP(24bit)
	Video	AVI, MPEG-1(mpg/dat), MPEG-4,
	Audio	Mp3,WMA
<b>Internal Speaker</b>	<b>Stereo</b>	<b>3W+3W</b>
Power	Adapter	Input: 100~240V AC, Output: 12V, 3ADC
	Electricity Consumption	16W(Operating)
<b>Size</b>	<b>Width*Height*Depth</b>	<b>420(w)*350(h)*55(d)[mm]</b>
Weight	Kg	3.2
<b>USB Connection</b>	<b>USBOTG, USB HOST</b>	<b>USB 2.0</b>

# Digital Photo Frame

## FCC and Safety Information

---

### • FCC Part 15.19

This device complies with Part 15 of the FCC Rules .Operation is subject to the following two conditions:(1) this device may not cause harmful interference , and (2) this device must accept any interference received ,including interference that may cause undesired operation .

### • FCC part 15.21

Warning: Changes or modifications to this unit not expressly approved by the party responsible for compliance could void the user' s authority to operate the equipment.

### • FCC part 15.105

Note : This equipment has been tested and found to comply with the limits for a Class B digital device ,pursuant to Part 15 of the FCC Rules, These limits are designed to provide reasonable protection against harmful interference in a residential installation .This equipment generates, uses, and can radiate radio frequency energy

and ,if not installed and used in accordance with the instructions, may cause harmful interference will not occur in a particular installation .If this equipment does cause harmful interference to radio or television reception ,which can be determined by turning the equipment off and on ,the user is encouraged to correct the interference by one or more of the following measures:

- Reorient or relocate the receiving antenna.
- Increase the separation between the equipment and receiver.
- Connect the equipment into an outlet on circuit different from that to which the receive is connected.
- Consult the dealer or an experienced radio TV technician for help.

Digital Photo Frame

**Sungale**

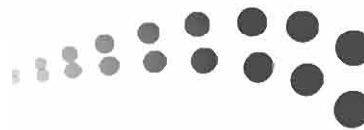

## Free Manuals Download Website

<http://myh66.com>

<http://usermanuals.us>

<http://www.somanuals.com>

<http://www.4manuals.cc>

<http://www.manual-lib.com>

<http://www.404manual.com>

<http://www.luxmanual.com>

<http://aubethermostatmanual.com>

Golf course search by state

<http://golfingnear.com>

Email search by domain

<http://emailbydomain.com>

Auto manuals search

<http://auto.somanuals.com>

TV manuals search

<http://tv.somanuals.com>