

Sungale
CD500A



Digital Photo Album User Manual



5

Contents

User Notice

The product has met electronic emission standards required.

This product can be used safely at home.



Chapter 1 Introduction

Product Introduction	3
Safety Precautions	4
Basic Features	8
Parts and Components	9

Chapter 2 Connection

Power Connection	13
PC Connection	14

Chapter 3 Usage

Photo	17
Music	19
Movie	21
E-Book	23
Photo+ Music	24

Chapter 4 Edit& Setup

Edit	26
Setup	31

Chapter 5 Customer Service

Questions and Answers	35
Troubleshooting	36
Product Specifications	37
FCC and Safety Information	38



Introduction

Production introduction	3
Safety Precautions	4
Main Features	8
Parts and Components	9
Basic Components	9
Electronics Frame	10

Product Introduction

This Digital Photo Album is a convenient album that keeps your favorite memories at your fingertips.

With its bright and vivid LCD screen, the Digital Photo Album offers you an alternative to photo printing, adds a new level of convenience to your life.

With its diverse file management functions, the Digital Photo Album allows you to relive your cherished memories anytime.

Safety Precautions

Make sure to review the following guidelines to ensure user safety and avoid product failure.

Electric Safety

⚠ WARNING: Indicates information that, if neglected, could result in serious injury or death.

⚠ CAUTION: Indicates information that, if neglected, could result in injury to the user and/or product damage.

01. Use only the authorized power supply accessory. Failure to do so could result in product malfunction.

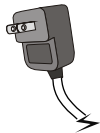

02. When connecting your Digital Photo Frame to a power source, make sure that your hands and feet are free of moisture. Failure to do so could result in electric shock.



Safety Precautions

Make sure to review the precautions to ensure user safety.

03. Make sure that the power supply is firmly plugged in and not loose. Failure to do so could result in electrical shock.

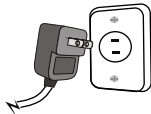

04. Do not let the power cord get overly entangled and do not place any heavy objects on the cord. Failure to do so could result in electrical shock.

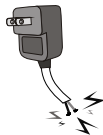

05. Do not connect the power supply to an electrical power strip with other various connections. Failure to do so could result in fire.



06. Disconnect the power supply during inclement weather conditions that include thunder and lightning. Failure to do so could result in fire.



Safety Precautions

Make sure to review the following guidelines to ensure user safety and avoid product failure

Product Related

01. Dropping the product, or subjecting it to a jolting impact may cause critical damage to the unit.



02. Spilling any liquid on the unit may cause critical damage to the unit.



03. Striking or scratching the LCD screen may cause permanent damage to the screen.

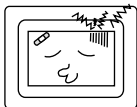

04. When cleaning the LCD screen, unplug the unit and wipe it gently with a soft cloth.

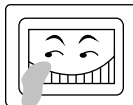

Safety Precautions

Make sure to review the following guidelines to ensure user safety and avoid product damage.

05. Subjecting the product to severe humidity and/or heat may cause product malfunction.

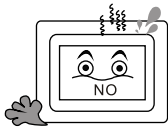

06. Turn the power off before connecting or disconnecting the power supply.

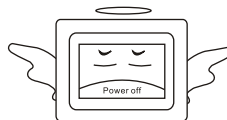

Main Features

1. Three-in-one function: photo browser, movie player, music player
2. On board 512MB memory , store your photo /movies directly
3. Slide show ,step show
4. USB Device to connect to your PC for file management
5. Built-in rechargeable battery

Note: The numbers of Photos, Songs and Movies to be stored to the Onboard Memory will vary due to the size of the file being saved.

Parts and Components

As ADS is constantly working to improve its products' performance, these components may be modified without notice.

The components may differ slightly in appearance with the images provided.

Basic Components

These components are included with your product.



Digital Photo Album



User Manual



Power Adaptor



USB Cable



Earphone

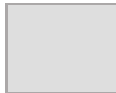

Cleaning pad



Quick-Start Guide

Part Names

The components provided may differ in appearance with the images provided.

Electronic Frame:

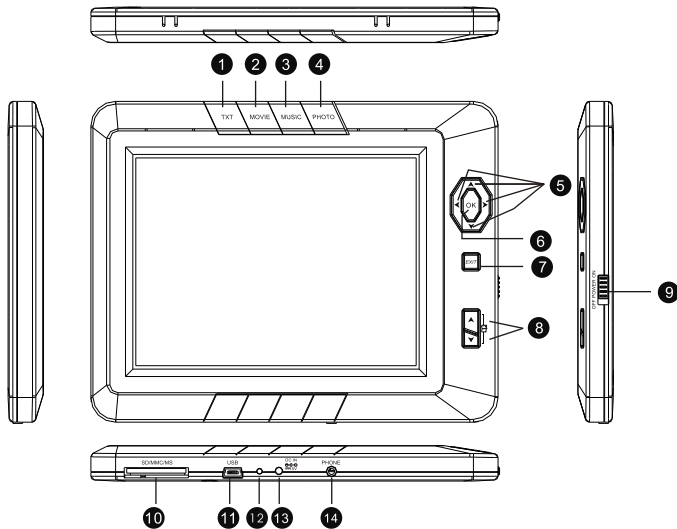

Main Features and Basic Operations

Front Side

- 1.TXT: Press to enter the E-book directory
- 2.MOVIE: Press to enter the movie directory.
- 3.MUSIC: Press to enter the music directory.
- 4.PHOTO: Press to enter the photo directory.
5. Directional Keys: Press to move the index to up /down/left/right.
- 6.OK: Press to enter/confirm .
- 7.EXIT: Press to exit the current page.
8.  : In photo Multi-screen/E-book directory, press to skip the previous/next page;
In music/video directory , press to skip to the previous/ next item.

Right Side

- 9.OFF POWER ON: Slide the button to left /right to turn on/off the DPA

Under Side

- 10.SD/MMC/MS: Insert SD/MMC/MS card.
- 11.USB : Connect to the USB cable from the DPA to PC .
12. Indicator: When the DPA is connected to the power, the red indicator will be lit
- 13.DC IN: Insert the DC power adapter to the DPA player.
14. PHONE: Insert for earphone use.



Chapter 2

Connection

Power Connection	13
PC Connection	14

Power Connection

Power Connection



1. Connect the power adapter to the DC IN 5V jack on the DPA
2. Plug the AC Adapter to a power jack to supply power to the DPA and charge for the built-in battery.

Note: If there is power in the built-in battery, you can use the player directly.

Don't unplug the power adaptor when the duration of charge is less than 30 minutes, or it may cause a white screen.

Use the supplied USB cable to connect your DPA to your PC.

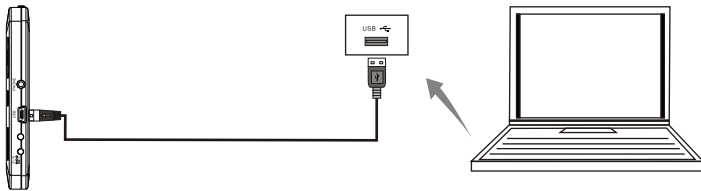

Note: The ASSP is a software developed by Sungale to manage the files in the Internal Memory to optimize the utilization of the source of the memory.

Start ASSP

On your computer, click “My computer”, then, click “StorageDevice Disk”, then, double click Fileconverter.exe, you will enter into ASSP interface.

- Tip : 1. If your PC has set as auto-run, you will enter into the ASSP interface directly, no operation needed.
2. The PC installed the anti-virus software or other hold-up software will make the “autorun.inf” invalid. In this situation, the file is set as hidden file. If you want to autorun the ASSP, you can set your PC to display hidden files.

Connecting your DPA to your PC

Use ASSP

1. Click "AddFile", your computer's files and folders will appear, double click the file or photo to add them to your DPA.
2. Hold on "Shift" or "Ctrl", you can download multi files or photos to your DPA.

In this way, the photos downloaded will be stored at 640X480 to suit your DPA's screen and the MP3 files will be transferred into WMA file.

When you finish the operation, safely remove the USB cable from your PC.

Tip: You also can take the DPA as a regular storage device, select the photos from your computer, then paste them in the DPA's internal memory. In this way, the photos will be stored without compression. If you want to optimize your internal memory, you can select the photos, then click the "Convert".

Attention: Once you format the internal memory of your DPA, the ASSP software will be deleted.

In this situation, you can still use the DPA as a regular storage device, and copy, paste, delete files after connecting your DPA to the PC,

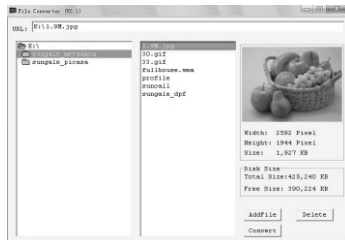



Chapter 3

Usage

Photo	17
Music	19
Movie	21
E-book	23
Photo/Music	24

Photo

Locating to the Photo Directory

I: Press the shortcut button PHOTO on the frame to display the top of the photo.

II: In the main menu, press or keep on pressing the directional buttons LEFT or RIGHT to select the item Photo. Press OK to enter the card selection interface, press the directional buttons LEFT or RIGHT to select cards, press OK to start displaying photos.

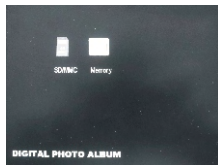
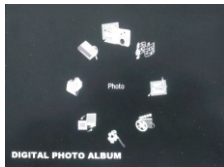

The Photos will be displayed in full screen automatically with slide show.



Press the button UP at the bottom right of the frame to skip to the previous picture.
Press the button DOWN at the bottom right of the frame to skip to the next picture.

Photo

View the photo in thumbnail mode

During photo play back, press the button EXIT to enter Thumbnail Mode and browse the photos. Press the directional buttons to select the desired photos. Press OK to view the photos with slide show.

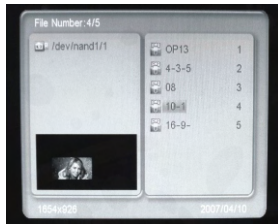

Pausing the photo

During photo play back, press OK to pause, and again to play.

Rotate

In photo slide show mode, press the directional buttons around OK to rotate the picture 90° or 180° .

In photo thumbnail mode, select the item Rotate; press the button OK repeatedly to rotate the picture counter clockwise or clockwise.

Exit

Press the EXIT button to photo browse mode, and again to the main menu.

Music

Locating to the Music Directory

- i. Press the shortcut button MUSIC on the top of the frame to enter the music file list.
- ii. In the main menu, press or keep on pressing the directional buttons LEFT or RIGHT to select the item MUSIC. Press Ok to enter the card selection interface, press the directional button LEFT or RIGHT to select card, press Ok to play music.

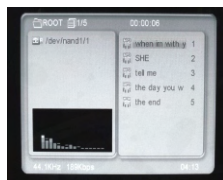
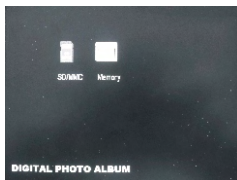

Choose a song

Press the directional buttons UP or DOWN around the OK button to select desired song in the file list.

Note: During playing and pausing, press button UP or DOWN at the bottom right of the frame to select.

Music

Playing a song

After selecting the desired song, press OK to start playing.

Pausing a song

During play back, press the OK button.

Adjusting the sound

During play back, press LEFT/RIGHT around the button OK to adjust the volume.

Exit

Press EXIT button to return to the main menu after pausing the music.

Movie

Locating to the Movie Directory

I: Press the shortcut button MOVIE to enter the movie list.

II: In the main menu, press or keep on pressing the directional buttons LEFT or RIGHT to select card, press OK to play the videos.

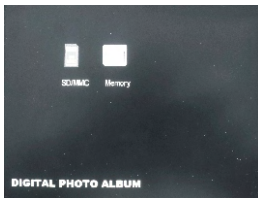
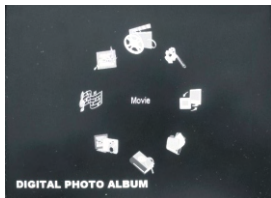

Press the button EXIT to enter the movie list.

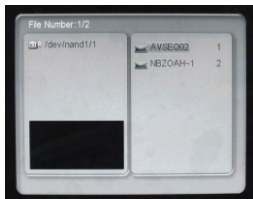

Adjusting volume

Press the buttons LEFT/RIGHT around OK to increase/decrease the volume.

Exit

Press EXIT to return to the main menu.

Playing a movie

In the movie list, press the directional buttons UP/DOWN around OK to select the desired movie, press OK to start to play.

During movie play back, press the button UP/DOWN at bottom right to select the previous and next movie.

Locating to the E-Book Directory

- i. Press the shortcut button TXT on the top of the frame to enter the E-Book file list.
- ii. In the main menu, press or keep on pressing the directional buttons LEFT or RIGHT to select the item E-Book , Press OK to enter the card selection interface, press the directional button LEFT or RIGHT to select card, press OK to enter the eBOOK file list.

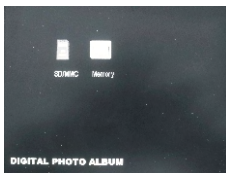

Reading a txt file

Press the directional buttons UP or DOWN around the button OK to select the desired txt file in the file list, press OK to read.

i: Upper row /Next row

Press the button UP or DOWN around OK to skip to the upper or next row.

li: Previous page:

Press button UP or DOWN at the bottom right of the frame to skip to the previous or next page.

Exit

Press EXIT to return to the main menu.

Photo+ Music

In the main menu, press or keep on pressing the directional buttons LEFT or RIGHT to select the item Photo+ Music, Press OK to enter the card selection interface, press the directional button LEFT or RIGHT to select card, press OK to start playing the photos with a musical slide show.

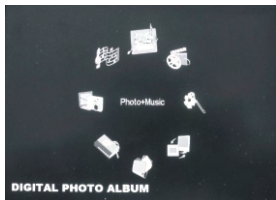

Exit

Press EXIT to return to the main menu.



Chapter 4

Edit & Setup

Edit	26
Setup	31

Edit

In the main menu, press or keep on pressing the directional buttons LEFT or RIGHT to select the item Edit.



Press OK, you will see the following screen:

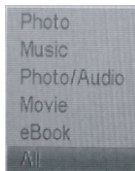

Select the items you want to edit, and press OK to enter the edit mode.

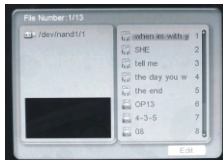

Edit

Press the buttons LEFT/RIGHT around OK to select the item Edit, and press OK. The screen will display as below:

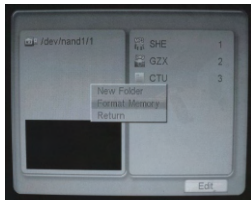

Create a new folder

Press the buttons UP/DOWN around OK to select the item New Folder. Press OK to create a new folder.

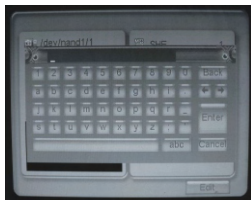

Edit

Format Memory

Press the buttons UP/DOWN around OK to select the item Format Memory. Press OK to format the memory.

The screen will return to the previous menu automatically. If not, unplug the AC adaptor and plug again to restart.

Copy& Paste File(s)

In the file list, select a file and press OK, make sure the file in the yellow frame; to copy more files, continue select files and press OK.

Press the buttons LEFT/RIGHT around OK to select the item Edit, and press OK. The screen will display as below:

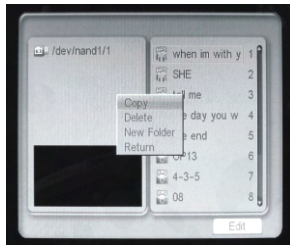

Edit

Press the buttons UP/DOWN around OK to select the item Copy. Press OK to copy a file.

Continue to press OK, the screen will display as below:

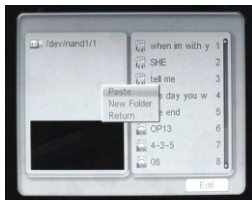

Select Paste and press OK, the desired file will be pasted.

If there is already a file using the same name, you can see the Warning page:

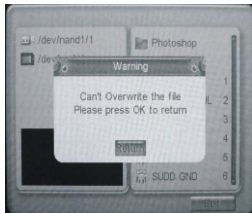

Press OK to give up overwriting the file and return to the previous menu.

Delete File(s)

In the file list, select a file and press OK, make sure the file in the yellow frame; to delete more files, continue to select files and press OK.

Press the buttons LEFT/RIGHT around OK to select the item Edit, and press OK.

Then press the buttons UP/DOWN around OK to select the item Delete. Press OK and select YES to delete the file(s).

SETUP

In the main menu, press or keep on pressing the directional buttons LEFT or RIGHT to select the item Setup. Press OK to enter the Setup Menu.

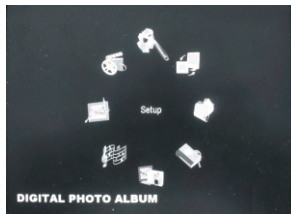

Photo Setting

When entering the Setup Menu, the screen will automatically display the Photo Setting:



SETUP

Press OK, and then press RIGHT button around OK to adjust the Interval Time. Press OFF to return to the previous menu.

Press OK, and then press RIGHT button around OK to adjust the Transition Effect.

Press OK, and then press RIGHT button around OK to adjust the Show Type.

Press OK, and then press RIGHT button around OK to adjust the Browse Mode.

Press LEFT button around OK to return to the Photo setting menu.

Auto-play

Enter the Setup menu, press the LEFT/RIGHT button around OK to select Auto-play, press OK to enter to set up auto play Photo/ Music/ Movie.



SETUP

Display Setup

Enter the Setup menu; press the LEFT/RIGHT button around OK to select Display Setup to adjust the Color/ Brightness/ Contrast.

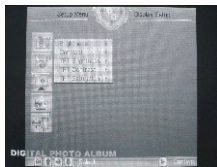

Custom Setup

Enter the Setup menu; press the LEFT/RIGHT button around OK to select Custom Setup to set up your custom settings mode.

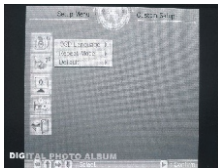

Exit

Enter the Setup menu; press the LEFT/RIGHT button around OK to select the Exit item to exit the Setup Menu.



Chapter 5

Customer Service

Questions and Answers	35
Troubleshooting	36
Product Specifications	37
FCC and Safety Information	38

Question and Answer

Question	Answer
What photo, music and video formats are supported by this Multi-media Digital Photo Album ?	Photo: JPG Music: WMA Video: MPEG
Does the player have a built-in memory?	Yes. The player has a 512MB internal memory to store media files . Do not rename the memory' s name.
Can I insert multiple memory cards?	Yes, you can insert one of SD,MMC, MS card each time.
Why doesn't the picture cover the entire screen?	The resolution of the picture to cover the entire screen must be greater than 640X480 pixels.
Can the DPA player connect with all computers?	No. The USB port of the PC must be USB 2.0 and the PC must have Windows 2000 or above.

Troubleshooting

If you are having problems with your unit, please consult the troubleshooting guide below. Some simple checks or minor adjustments may restore proper operation.

No Power

Ensure that you are pressing and holding the power button for at least 2 seconds.

Ensure the power outlet is operational

Ensure the power cord is not damaged

Ensure the power plug is connected firmly to the outlet.

Unit NOT working

Turn the unit off and then on again.

Specifications

Product Specifications

Audio File Formats :WMA

Photo File Formats: JPG

Video File Formats: MPEG

E-book File Formats: TXT

Memory Cards Supports: SD/MMC/MS

USB Connection: USB2.0

Display panel: 5" TFT LCD 640 (RGB)* 480

Power: AC Adapter; Input 110-240V ; Output 5V, 2A

Accessories:

AC Adapter

User Manual

USB Cable

Earphone

Cleaning pad

Quick-Start Guide

Note: All data are provided for reference purposes only. Sungale reserves the right to make any changes without prior notice.

FCC and Safety Information

- **FCC Part 15.19**

This device complies with Part 15 of the FCC Rules .Operation is subject to the following two conditions: (1) this device may not cause harmful interference , and (2) this device must accept any interference received ,including interference that may cause undesired operation .

- **FCC part 15.21**

Warning: Changes or modifications to this unit not expressly approved by the party responsible for compliance could void the user's authority to operate the equipment.

• **FCC part 15.105**

Note : This equipment has been tested and found to comply with the limits for a Class B digital device ,pursuant to Part 15 of the FCC Rules, These limits are designed to provide reasonable protection against harmful interference in a residential installation .This equipment generates, uses, and can radiate radio frequency energy and ,if not installed and used in accordance with the instructions, may cause harmful interference will not occur in a particular instructions. If this equipment does cause harmful interference to radio or television reception ,which can be determined by turning the equipment off and on ,the user is encouraged to correct the interference by one or more of the following measures :

- Reorient or relocate the receiving antenna.
- Increase the separation between the equipment and receiver.
- Connect the equipment into an outlet on circuit different form that to which the receive is connected.
- Consult the dealer or an experienced radio TV technician for help.

LIMITED WARRANTY

The limited warranty set forth below is given by the manufacturer with respect to Sungale brand DPF players and other consumer electronics products purchased and used in the United States of America. The manufacturer warrants this product against defects in material or workmanship as follows:

LABOR: For a period of ninety (90) days from the date of purchase if this Product is defective, the manufacturer will repair or replace the Product, at its option, at no charge. After this ninety (90) days period up to one year, a labor charge of US\$30.00 will be charged for each service.

PARTS: For a period of one year from the date of purchase, the manufacturer will supply, at no charge, new or rebuilt replacement parts in exchange for defective parts. After this one year period, the manufacturer will charge the new or replacement parts.

This warranty does not cover: (1) customer instruction, installation or set up; (2) cosmetic damage or damage due to accident, misuse, abuse, or negligence; (3) commercial use of the Product; (4) modification of any part of the Product; (5) damage due to improper operation, improper maintenance, or connection to an improper voltage supply; (6) damage due to an attempted repair of the Product by anyone other than a facility authorized by the manufacturer to service the Product; (7) consumables (such as fuses and batteries). This warranty is valid only in the United States.

The product must be accompanied by a copy of the original retail purchase receipt. If no proof of purchase is attached, the warranty will not be honored and repair cost will be charged.

This warranty is valid with attach written documentation detailing the complaint to the outside or inside of the carton.

This warranty is invalid if the factory applied serial number has been altered or removed from the Product.

The manufacturer reserves the right to modify any design of this product without prior notice.

To obtain warranty service, you must deliver the product freight prepaid, in either its original packaging or packaging affording an equal degree of protection, plus proof of purchase, to:

Service Center
13941 Central Ave,
Chino, CA 91710
Tel: **800-473-5156**

REPAIR OR REPLACEMENT AS PROVIDED UNDER THIS WARRANTY IS THE EXCLUSIVE REMEDY OF THE CONSUMER. THE SERVICE CENTER SHALL NOT BE LIABLE FOR ANY INCIDENTAL OR CONSEQUENTIAL DAMAGES FOR BREACH OF ANY EXPRESS OR IMPLIED WARRANTY ON THIS PRODUCT. EXCEPT TO THE EXTENT PROHIBITED BY APPLICABLE LAW, ANY IMPLIED WARRANTY OF MERCHANTABILITY OR FITNESS FOR A PARTICULAR PURPOSE ON THIS PRODUCT IS LIMITED IN DURATION TO THE DURATION OF THIS WARRANTY.

Some states do not allow the exclusion or limitation of incidental or consequential damages, or allow limitations on how long an implied warranty lasts, so the above limitations or exclusions may not apply to you. This warranty gives you specific legal rights, and you may have other rights which vary from state to state.



Free Manuals Download Website

<http://myh66.com>

<http://usermanuals.us>

<http://www.somanuals.com>

<http://www.4manuals.cc>

<http://www.manual-lib.com>

<http://www.404manual.com>

<http://www.luxmanual.com>

<http://aubethermostatmanual.com>

Golf course search by state

<http://golfingnear.com>

Email search by domain

<http://emailbydomain.com>

Auto manuals search

<http://auto.somanuals.com>

TV manuals search

<http://tv.somanuals.com>