

# Sungate

PF 1023



## *Digital Photo Frame User's Manual*



10.2

For ongoing product improvement, this manual is subject to modification without prior notice.

Download from [Www.Somanuals.com](http://Www.Somanuals.com). All Manuals Search And Download.

## User Notice

---

This product has met electronic emissions standards required. It can be used safely at home.



## Contents

---

### Before Operation

---

Product Introduction	2
Safety Precautions	3
Package Contents	5
Photo Frame Overview	6

### Basic Operation

---

Remote control	7
Power Connection	8
Insert a memory card	9
Photos	10
Favourite	11

### Advanced Operation

---

Setup	12
Calender	14
Clock	15
Edit	16

### Customer Management

---

Question&Answer	18
Troubleshooting	19
Specifications	20

# Before Operation

---

## Product Introduction

---

Our Digital Photo Frame is a convenient image frame that keeps your favorite images at your fingertips.

With its bright and vivid LCD screen, the Digital Photo Frame eliminates the need for tedious photo printing and injects a new level of convenience into your life.

With its diverse file management functions, this Digital Photo Frame allows you to relive wonderful memories anytime.

You can use the Digital Photo Frame to enjoy memories by presenting them with refined images.

# Before Operations

## Safety Precautions

Please read the following guidelines carefully to ensure user safety.

### Power Precautions

**⚠ WARNING:** indicates information that, if neglected, could result in serious injury and/or death to the user.

**⚠ CAUTION:** indicates information that, if neglected, could result injury to the user and/or material damage.

**01. Use only the authorized power supply product.** Failure to do so could result in product malfunction.



**02. When connecting the power source, make sure that your hands are free of moisture.** Failure to do so could result in electrical shock.



**03. Make sure that the power supply is firmly plugged in and not loose.** Failure to do so could result in electrical shock.

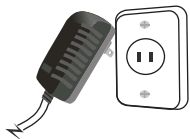

**04. Do not let the power cord get overly entangled and do not place any heavy objects on the cord.** Failure to do so could result in electrical shock.

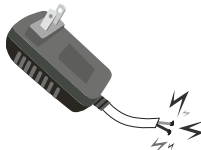

**05. Do not connect the power supply to an electrical power strip with other various connections.** Failure to do so could result in fire.

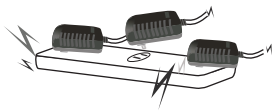

**06. Disconnect the power supply during inclement weather conditions that include thunder and lightning.** Failure to do so could result in fire.

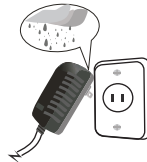

# Before Operations

## Safety Precautions

Please read the following guidelines carefully to ensure user safety and avoid malfunction.

### Product Related Precautions

01. Dropping the product or subjecting it to a significant impact can cause critical damage.



02. Spilling water or any other liquid on the product can cause critical damage.



03. Striking or scratching the LCD screen may cause critical damage.

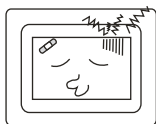

04. When cleaning the LCD screen, turn off the power and wipe it gently with a soft cloth.

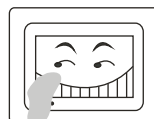

05. Do not subject the product to severe humidity and/or heat.

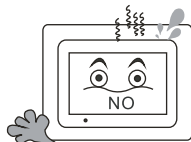

06. Make sure to power off the unit before disconnecting the power supply.

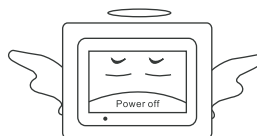

# Before Operations

---

## Package Contents

---

For the improvement of product performance and/or quality, the basic components may be modified without prior notice. The components may differ slightly in appearance with the provided images.

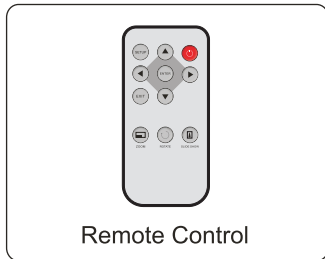
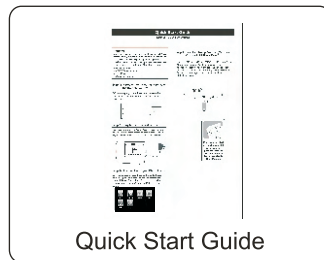
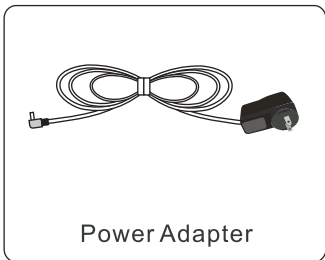
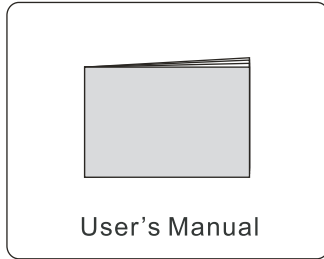
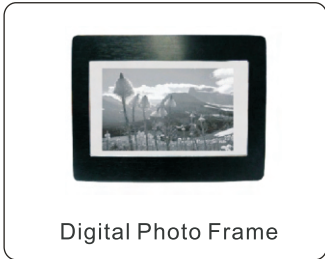

# Before Operations

## Photo Frame Overview

The package contents may differ slightly in appearance with the provided images

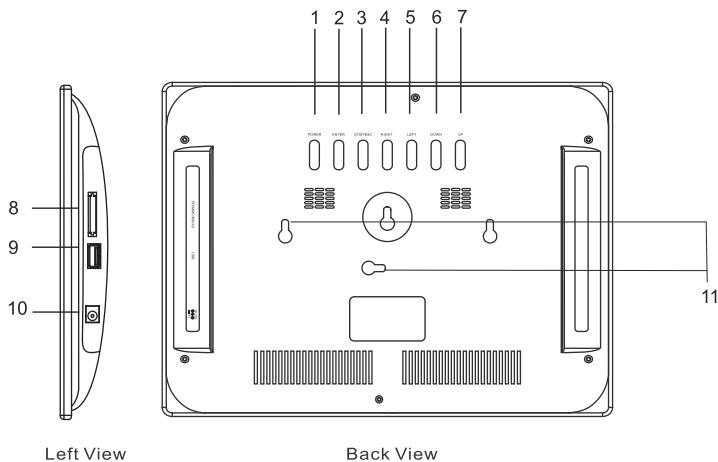

### Back View

1. POWER: Press to power on/off the unit.
2. ENTER: Press to confirm or enter, play or pause.
3. STOP/ESC: Stop the current action and return to the previous menu.
4. RIGHT: Press to move the cursor right.
5. LEFT: Press to move the cursor left.
6. DOWN: Press to move the cursor to the previous icon.
7. UP: Press to move the cursor to the next icon.

### Left View

8. SD/MMC/MS/XD CARDS: Insert SD/MMC/MS/XD cards.
9. USB: Connect the USB portable flash device.
10. DC IN: Insert the DC power adapter to the phone frame.
11. WALL MOUNTABLE HOLE.

# Basic Operations

## Remote Control



### **Power:**

Press the button to turn the player on or off.

### **Setup:**

Press to enter into the setting interface.

### **Enter:**

Press to play or pause, confirm or enter.

### **Navigation buttons:**

▲ : Press to move the cursor up or flip horizontally.

▼ : Press to move cursor down or flip vertically.

◀ : Press to move the cursor left or to the next picture.

▶ : Press to move the cursor right or to the next picture.

### **EXIT:**

Press to exit from the present interface.

### **ZOOM:**

Press to zoom in or out the image.

### **ROTATE:**

Press to rotate the picture to different angle.

### **SLIDE SHOW:**

Press to slide the photos or turn the slide show on and off.

**Note:** Remove Insulating Tab to activate battery.



# Basic Operations

---

## Power Connection

---

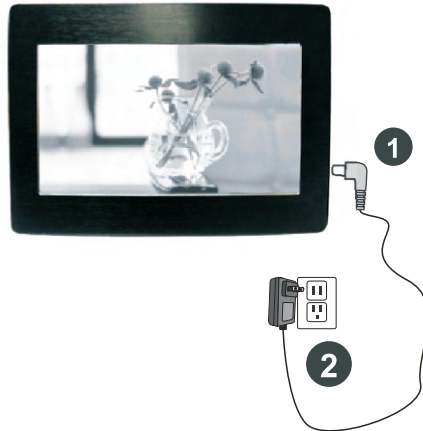

1. Connect the power adapter to the DC IN jack on the left side of the frame.
2. Plug on the power cord.
3. The frame will automatically power on.

# Basic Operations

---

## Insert a memory card

---

Insert card in the direction indicated by the arrow on the top of the card (the side of the memory card on which sticker is affixed face the frame).

SD, Memory Stick, MMC cards, XD cards are compatible with this unit. Aligning the memory card upside down may cause user-error damage. This may nullify the warranty.

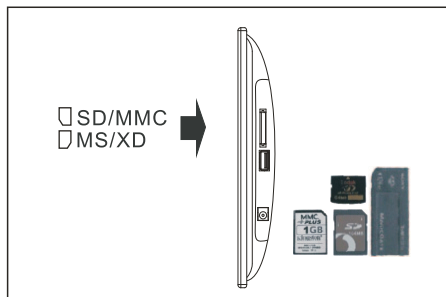

## USB Removable Storage Devices

Insert USB removable storage device into the USB port on the side of the frame.

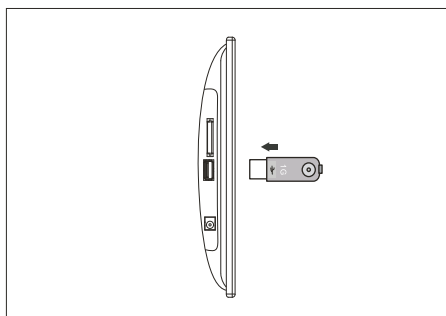

NOTE: This device will read USB first and will not recognise the memory card if you insert a memory card and extra USB memory together at the same time.

## Removing the Memory Card

When removing a memory card from the frame, pull the card straight away from the unit. Avoid bending the card.

# Basic Operations

## Photos

### Display Photos

**Note:** The frame will display pictures in the memory card or USB device first if there is a memory card or USB device is inserted to the frame before connecting power. Otherwise it will display the pictures in the internal memory.

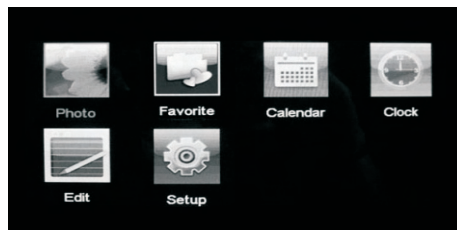

**Tip 1.** Press the shortcut button SLIDE SHOW on the remote control to display the images.

**Tip 2.** In the main menu, select PHOTO icon and press ENTER to enter into the storage selecting mode, select the storage and press ENTER again. Select the desired photo and press ENTER to begin a photo slide show.

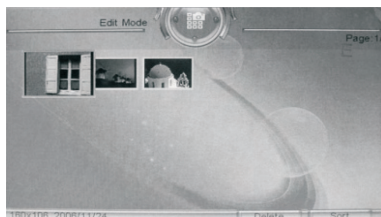
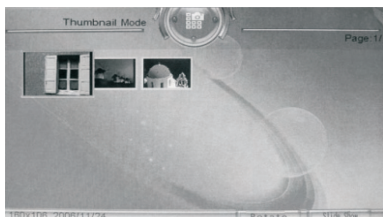

### Thumbnail Mode and Edit Mode

When displaying, press ◀ or ▶ to move to previous or next photo, press EXIT to enter into Thumbnail Mode. If there is no extra device, you will enter into the Edit Mode.

Select the Return icon in Thumbnail Mode and press ENTER to return to previous menu.

# Basic Operations

---

## Photos

---

### Rotate a Photo

**Tip 1.** When displaying images, press the ROTATE on the remote control to rotate the displaying photo for 90 once an operation.

**Tip 2.** In Thumbnail Mode, activate the Rotate icon, and press ENTER to rotate desired picture.



### Zoom in/out a photo

Press the shortcut button Zoom on the remote control to zoom in or zoom out the desired photo.

### Exit

Press EXIT on the remote control or press the STOP/ESC button on the back of unit to return to the previous menu.

## Favourite

---

You can copy and paste images from extra devices to your digital photo frame, and they will be stored under the Favourite menu.

Select the Favourite icon and press ENTER to display the images.

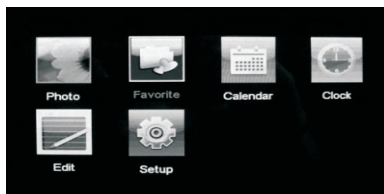

# Advanced Operations

## Setup

### Enter Setup Interface

**Tip 1.** Press the SETUP button on the remote control to enter the Setup interface.

**Tip 2.** Select Setup icon in the main menu and press ENTER to enter Setup interface.

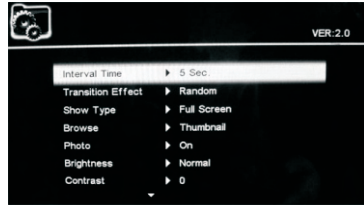
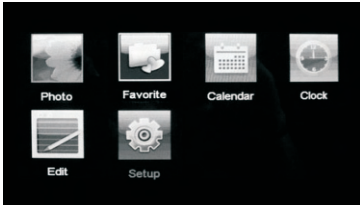

### Setting Menu guide

Press ▲ or ▼ to select the desired item, and press ENTER to confirm. Press ◀ or ▶ to change the value.

#### Interval Time

Select to set the desired time that make the image remains on the screen in slide show mode.

#### Transition Effect

Select to set the desired transfer effect in slide show mode.

#### Show Type

Select to set the desired photo displaying type.

#### Browse

Select to set the browse mode to pre-view photos in Thumbnail Mode and File Manager Mode.

#### Photo

Select to set the photo displaying auto or not

- 1.Set to On: It will auto display the photos in slide show mode.
- 2.Set to Off: For manual play.

#### Brightness

Select to adjust the displaying brightness with Normal/Bright/Soft.

#### Contrast

Select to adjust the displaying contrast.

# Advanced Operations

---

## Setup

---

### TFT Brightness

Select to adjust the TFT Brightness.

### TFT Contrast

Select to adjust the TFT Contrast.

### TFT Saturation

Select to adjust the TFT Saturation.

### OSD Language

Select to display the language of this unit.

### Repeat Mode

Select to change the repeat mode:

**One:** repeat one picture only.

**Folder:** repeat pictures in a file.

**All:** repeat all of the photos.

**Off:** cancel the repeat mode.

### Default

Select to reset the unit to factory default.

### Set Time

Select to set the time of this unit.

### Set Date

Select to set the date of this unit.

**Note:** When setting time and date, press ◀ or ▶ to select time item and date item.  
Press ▼ or ▲ to change the value.

### Exit

Press EXIT to return to the main menu.

# Advanced Operations

---

## Calendar

---

Select the Calendar icon in the main menu, and press ENTER to display the calendar.  
Press the navigation buttons to select the date in further or past.

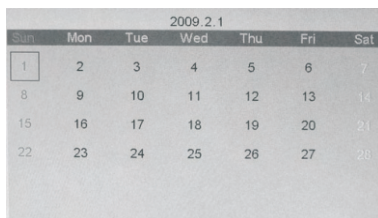
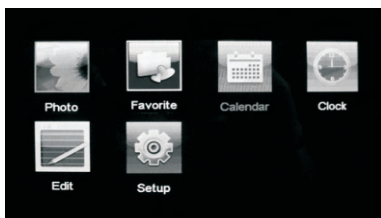

2009.2.1						
Sun	Mon	Tue	Wed	Thu	Fri	Sat
1	2	3	4	5	6	7
8	9	10	11	12	13	14
15	16	17	18	19	20	21
22	23	24	25	26	27	28

## Exit

Press EXIT on the remote control to return to the main menu.

**Note:** After plug off, the calendar and clock need to be reset.

# Advanced Operations

## Clock

Select the Clock icon in the main menu and press ENTER to select the clock display mode, and use the navigation buttons to select the items, press ENTER to confirm operation.

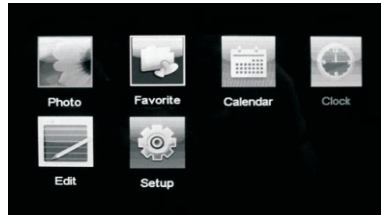

### Display mode:

Select to set the follow items:

**DigitalClock:** select to display the digital clock.

**Analog Clock:** select to display the analog clock.

**Clock & Calendar:** select to display the Calendar with digital clock.

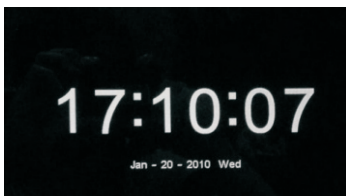

Digital Clock



Analog Clock



Clock & Calendar

### Exit

Select to return to the main menu.

**Note:** After power off, the calendar and clock need to be reset.



# Advanced Operations

## Edit

**Note:** Adding the pictures from external memory to the digital photo frame, or deleting the pictures stored in the digital photo frame.

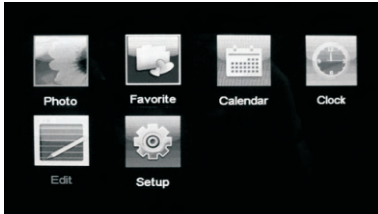

## Copy

**Step 1.** Select Edit icon in the main menu, and press ENTER to display the Edit Dialog.

**Step 2.** Select Copy icon and press ENTER to enter into the file list.

**Step 3.** Use the navigation buttons to select the desired images, and press ENTER to confirm. To copy more, continue select images and confirm.

**Step 4.** Press the ◀ or ▶ to move the cursor to the Save icon, and press ENTER to begin copy the images.

**Step 5.** After saving, select the Exit icon to return to the main menu.

# Advanced Operations

---

## Edit

---

### Delete

Note: Pictures deleted cannot be recovered. Think over before you confirm to delete.

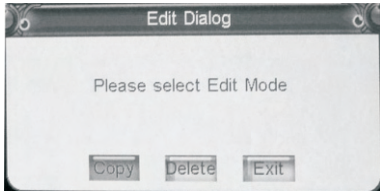

Step 1. Select Edit icon in the main menu, and press ENTER to display the Edit Dilaog.

Step 2. Select Delete icon and press ENTER to enter into the file list.

Step 3. Press ▼ button to select Delete icon and press ENTER to back to the images.

Step 4. Press navigation buttons to select the image you prefer to delete, press ENTER to delete. Continue selecting images and press ENTER to delete more.

Step 5. Press the navigation buttons to select the Return icon to back of Edit Mode.

### Sort

Press ▼ button to select Sort icon in Edit Mode, and press ENTER to move the images. Then select the image you prefer to move, press ◀ or ▶ to make the image in order.

# Customer Management

---

## Question & Answer

---

This chapter will attempt to troubleshoot common problems that one may experience with the Multimedia DPF. If this guide does not solve your problem, do not dismantle the machine yourself.

Question	Answer
What is the main function of the digital photo frame?	Using the digital photo frame, you can display images, calendar and clock.
Does Digital Photo Frame have built-in memory?	Yes. The player has an internal memory to store 8 photos. Do not rename the memory's name.
What memory card are compatible with the digital photo frame?	The unit can be compatible with SD/MMC/XD/MS card.
Why picture display seems slow?	You are viewing high-resolution pictures, it can take some time to display.
Why the unit can't display pictures?	Make sure the pictures are in JPEG format. Make sure you have inserted a card or USB device properly and selected the PHOTO icon in the main menu. or make sure there are pictures in the internal memory and you have selected the FAVORITE icon in the main menu.
How can I see the file list?	Please set Browse item Setup Menu to File Manager.

# Customer Management

---

## Troubleshooting

---

Some simple checks or a minor adjustment eliminate common problems:

### No power

1. Check the power button is on.
2. Check the power outlet is operational.
3. Check the power cord for damages.
4. Check the power plug is firmly connected to photo frame.

### Can not read the card

1. Check the card for damages.
2. Check the card is connected the photo frame correctly.
3. Pull out the card, and then insert again.

### Photo Frame is not working

Trun off the power, and then turn it on again.

# Customer Management

---

## Specifications

---

Display: 10.2" TFT LCD Digital Screen

Resolution: 800(RGB) x 480 (Pixels) (16:9)

Power: AC Adapter, Input 110-220V ; Output 5V

### Environmental operating ranges

Operation: 32~95 F, Humidity 0~85%

Storage: -4~140 F, Humidity 10~90%

Note: All data are provided for reference purposes only. Sungale reserves the right to make any changes without prior notice.

The numbers of photos to be stored to the Onboard Memory will vary due to the size of files being saved.

# FCC and Safety Information

---

## • FCC Part 15.19

This device complies with Part 15 of the FCC Rules .Operation is subject to the following two conditions: (1) this device may not cause harmful interference , and (2) this device must accept any interference received ,including interference that may cause undesired operation .

## • FCC part 15.21

Warning: Changes or modifications to this unit not expressly approved by the party responsible for compliance could void the user's authority to operate the equipment.

## • FCC part 15.105

Note : This equipment has been tested and found to comply with the limits for a Class B digital device ,pursuant to Part 15 of the FCC Rules, These limits are designed to provide reasonable protection against harmful interference in a residential installation .This equipment generates, uses, and can radiate radio frequency energy and ,if not installed and used in accordance with the instructions, may cause harmful interference will not occur in a particular installation .If this equipment does cause harmful interference to radio or television reception ,which can be determined by turning the equipment off and on ,the user is encouraged to correct the interference by one or more of the following measures:

- Reorient or relocate the receiving antenna.
- Increase the separation between the equipment and receiver.
- Connect the equipment into an outlet on circuit different form that to which the receiver is connected.
- Consult the dealer or an experienced radio TV technician for help.

# LIMITED WARRANTY

The limited warranty set forth below is given by the manufacturer with respect to Sungale brand DPF players and other consumer electronics products purchased and used in the United States of America. The manufacturer warrants this product against defects in material or workmanship as follows:

**LABOR:** For a period of ninety (90) days from the date of purchase if this Product is defective, the manufacturer will repair or replace the Product, at its option, at no charge. After this ninety (90) days period up to one year, a labor charge of US\$30.00 will be charged for each service.

**PARTS:** For a period of one year from the date of purchase, the manufacturer will supply, at no charge, new or rebuilt replacement parts in exchange for defective parts. After this one year period, the manufacturer will charge the new or replacement parts.

This warranty does not cover: (1) customer instruction, installation or set up; (2) cosmetic damage or damage due to accident, misuse, abuse, or negligence; (3) commercial use of the Product; (4) modification of any part of the Product; (5) damage due to improper operation, improper maintenance, or connection to an improper voltage supply; (6) damage due to an attempted repair of the Product by anyone other than a facility authorized by the manufacturer to service the Product; (7) consumables (such as fuses and batteries). This warranty is valid only in the United States.

The product must be accompanied by a copy of the original retail purchase receipt. If no proof of purchase is attached, the warranty will not be honored and repair cost will be charged.

This warranty is valid with attach written documentation detailing the complaint to the outside or inside of the carton.

This warranty is invalid if the factory applied serial number has been altered or removed from the Product.

The manufacturer reserves the right to modify any design of this product without prior notice.

To obtain warranty service, you must deliver the product freight prepaid, in either its original packaging or packaging affording an equal degree of protection, plus proof of purchase, to:

Service Center  
13941 Central Ave,  
Chino, CA 91710  
Tel: **800-473-5156**

REPAIR OR REPLACEMENT AS PROVIDED UNDER THIS WARRANTY IS THE EXCLUSIVE REMEDY OF THE CONSUMER. THE SERVICE CENTER SHALL NOT BE LIABLE FOR ANY INCIDENTAL OR CONSEQUENTIAL DAMAGES FOR BREACH OF ANY EXPRESS OR IMPLIED WARRANTY ON THIS PRODUCT. EXCEPT TO THE EXTENT PROHIBITED BY APPLICABLE LAW, ANY IMPLIED WARRANTY OF MERCHANTABILITY OR FITNESS FOR A PARTICULAR PURPOSE ON THIS PRODUCT IS LIMITED IN DURATION TO THE DURATION OF THIS WARRANTY.

Some states do not allow the exclusion or limitation of incidental or consequential damages, or allow limitations on how long an implied warranty lasts, so the above limitations or exclusions may not apply to you. This warranty gives you specific legal rights, and you may have other rights which vary from state to state.

Digital Photo Frame

**Sungale**



## Free Manuals Download Website

<http://myh66.com>

<http://usermanuals.us>

<http://www.somanuals.com>

<http://www.4manuals.cc>

<http://www.manual-lib.com>

<http://www.404manual.com>

<http://www.luxmanual.com>

<http://aubethermostatmanual.com>

Golf course search by state

<http://golfingnear.com>

Email search by domain

<http://emailbydomain.com>

Auto manuals search

<http://auto.somanuals.com>

TV manuals search

<http://tv.somanuals.com>