

# Mobile Broadband USB Modem

MD400 HSPA/UMTS/EDGE

MD400g HSPA/UMTS/EDGE and GPS

## User Guide



# Contents

<b>Contents</b> .....	<b>ii</b>
<b>Regulatory information</b> .....	<b>v</b>
Declaration of conformity .....	v
FCC statement .....	vi
Déclaration FCC .....	vii
Industry Canada Statement .....	viii
RF Exposure Caution Notice .....	viii
<b>About this guide</b> .....	<b>ix</b>
How this guide is organised .....	ix
Additional resources .....	ix
<b>Overview</b> .....	<b>1</b>
Checklist .....	1
MD400/MD400g Communications Summary .....	1
Hardware overview .....	2
Status LEDs .....	4
SIM Card .....	4
Attach the Lanyard .....	6
MD400 memory card slot .....	7
Antennas .....	9
Global Positioning System .....	9
Network and subscription requirements .....	9
Connecting your MD400 to your PC .....	10
USB 1.1 and 2.0 .....	12
Software overview .....	13
System requirements .....	14
<b>Additional information</b> .....	<b>15</b>
Guidelines for safe and efficient use .....	15
Generic SEMC Limited warranty .....	17
<b>Technical specifications</b> .....	<b>20</b>
<b>Index</b> .....	<b>26</b>

## **Sony Ericsson MD400 Mobile Broadband USB Modem**

First edition (October 2008)

This manual is published by Sony Ericsson Mobile Communications AB, without any warranty. Improvements and changes to this manual necessitated by typographical errors, inaccuracies of current information, or improvements to programs and/or equipment, may be made by Sony Ericsson at any time and without notice. Such changes will, however, be incorporated into new editions of this manual.

This manual is copyrighted work of Sony Ericsson Mobile Communications AB, Sweden. The programs referred to herein are copyrighted and trademarked works of Sony Ericsson Mobile Communications AB, Sweden. Reproduction in whole or in part, including utilisation in machines capable of reproduction or retrieval, without the express written permission of the copyright holders is prohibited. Reverse engineering is also prohibited.

Windows and Vista are registered trademarks or trademarks of Microsoft Corporation in the United States and/or other countries.

Adobe and Reader are either registered trademarks or trademarks of Adobe Systems Incorporated in the United States and/or other countries.

All other product or service names mentioned in this manual are trademarks of their respective companies.

All rights reserved.

© Sony Ericsson Mobile Communications AB, 2008

Publication number: 1212-7288.1



# Regulatory information

## Declaration of conformity

We, **Sony Ericsson Mobile Communications AB** of  
Nya Vattentornet  
S-221 88 Lund, Sweden

declare under our sole responsibility that our product

**MD400 Sony Ericsson type FAD-3232022-BV**  
**MD400g Sony Ericsson type FAD-3232023-BV**

and in combination with our accessories, to which this declaration relates, is in conformity with the appropriate standards: EN 301 511:V9.0.2, EN 301 908-1:V2.2.1, EN 301 908-2:V2.2.1, EN 300 440-1:V1.7.1 (EC400g only), EN 300 440-2:V1.1.2 (EC400g only), EN 301 489-7:V1.3.1, EN 301 489-24:V1.3.1, EN 301 489-3:V1.4.1 (EC400g only), EN 61000-6-3:2007, EN 61000-6-1:2007, and EN 60 950-1:2006 following the provisions of Radio Equipment and Telecommunication Terminal Equipment directive 99/5/EC with requirements covering EMC directive 89/336/EEC, and Low Voltage directive 73/23/EEC.

**CE 0682**

Research Triangle Park, North Carolina. October 2008

*Place and date of issue*



Najmi Jarwala  
President - US & Canada  
Sony Ericsson Mobile Communications (USA) Inc.

We fulfil the requirements of the R&TTE Directive (99/5/EC).

FR Ce produit est conforme à la directive R&TTE (99/5/EC).

AR إتّنا نحترم بمقتضيات التوجيهات R&TTE (99/5/EC).

CS Výrobek splňuje požadavky směrnice R&TTE (99/5/EC).

DA Vi opfylder kravene i R&TTE-direktivet (99/5/EC).

DE Die Anforderungen der Richtlinie für Funk- und Fernmeldegeräte (99/5/EG) werden erfüllt.

EL Πληρούμε τις απαιτήσεις της Οδηγίας R&TTE (99/5/EK).

ES Cumplimos los requisitos de la Directiva R&TTE (99/5/EC).

FI Täytämme radio- ja telepääteläitedirektiivin (99/5/EY) asettamat vaatimukset.

HR Mi ispunjavamo zahtjeve R&TTE Direktive (99/5/EC).  
HU Teljesítjük az R&TTE irányelv (99/5/EC) követelményeit.  
IT Il prodotto soddisfa i requisiti della Direttiva R&TTE (99/5/EC).  
NL We voldoen aan de vereisten die in de R&TTE-richtlijn (99/5/EG) worden gesteld.  
NO Vi oppfyller kravene i R&TTE-direktivet (99/5/EC).  
PL Spełniamy wymagania dyrektywy R&TTE (99/5/WE).  
PT São cumpridos os requisitos da Directiva R&TTE (99/5/EC).  
PB Atendemos aos requisitos da Diretriz R&TTE (99/5/EC).  
RO Îndeplinim cerințele directivei R&TTE (99/5/EC).  
RU Изделие удовлетворяет требованиям Директивы R&TTE (99/5/EC).  
SK Výrobok spĺňa požiadavky smernice R&TTE (99/5/EC).  
SV Vi uppfyller kraven i R&TTE-direktivet (99/5/EC).  
TH เราปฏิบัติตามข้อกำหนดของข้อบังคับ R&TTE Directive (99/5/EC)  
TR R&TTE Kararnamesinin (99/5/EC) gerekliliklerini yerine getirmektediriz.  
UK Цей Виріб відповідає вимогам Директиви R&TTE (99/5/EC).  
ZS 我们符合 R&TTE 指令 (99/5/EC) 的要求。  
ZT 本公司符合 R&TTE Directive (99/5/EC) 中的規定。

## FCC statement



**MD400 FCC ID:** PY7F3232022

**MD400 IC:** 4170B-F3232022

**MD400g FCC ID:** PY7F3232023

**MD400g IC:** 4170B-F3232023

This equipment has been tested and found to comply with the limits for a Class B digital device, pursuant to Part 15 of the FCC Rules. These limits are designed to provide reasonable protection against harmful interference in a residential installation. This equipment generates, uses and can radiate radio frequency energy and, if not installed and used in accordance with the instructions, may cause harmful interference to radio communications. However, there is no guarantee that interference will not occur in a particular installation. If this equipment does cause harmful interference to radio or television reception, which can be determined by turning the equipment off and on, the user is encouraged to try to correct the interference by one or more of the following measures:

- Reorient or relocate the receiving antenna.
- Increase the separation between the equipment and receiver.
- Connect the equipment into an outlet on a circuit different from that to which the receiver is connected.
- Consult the dealer or an experienced radio/TV technician for help.

**WARNING:** Changes or modifications made to this equipment not expressly approved by Sony Ericsson Mobile Communications AB may void the FCC authorization to operate this equipment.

**CAUTION:** The Sony Ericsson USB device has been tested for compliance with FCC/IC RF exposure limits in the laptop computer(s) configurations with a USB port and can be used in laptop computers with substantially similar physical dimensions, construction, and electrical and RF characteristics.

Note: If this Sony Ericsson USB device is intended for use in any other portable device, you are responsible for separate approval to satisfy the SAR requirements of Part 2.1093 of FCC rules.

## Déclaration FCC



**ID FCC :** PY7F3232021

**IC :** 4170B-F3232021

Cet appareil a été testé et déclaré conforme aux limites d'un appareil numérique de classe B en vertu de l'article 15 de la réglementation FCC. Ces limites permettent d'être correctement protégé contre les interférences nuisibles dans une installation résidentielle. Le présent appareil émet, utilise et peut engendrer des signaux HF (haute fréquence). Si vous ne l'installez pas et ne l'utilisez pas conformément aux instructions, il peut provoquer des interférences préjudiciables aux communications radio. Il n'existe toutefois aucun dispositif garantissant la non-apparition de ce type d'interférences dans une installation déterminée. Si cet appareil provoque des interférences dommageables à la réception radiophonique ou télévisée (détectables en mettant l'appareil hors tension, puis à nouveau sous tension), nous conseillons à l'utilisateur d'essayer de les éliminer en appliquant une ou plusieurs mesures ci-après :

- réorienter ou déplacer l'antenne de réception ;
- augmenter l'écart séparant l'appareil du récepteur ;
- brancher l'équipement dans une prise située sur un circuit différent de celui utilisé pour la connexion du récepteur ;
- consulter le revendeur ou un technicien radio/TV expérimenté.

**AVERTISSEMENT :** Les changements ou modifications opérés sur le présent appareil sans l'approbation expresse de Sony Ericsson Mobile Communications AB peuvent frapper de nullité l'autorisation FCC relative à l'utilisation de l'appareil précité.

**ATTENTION :** Le dispositif USB Sony Ericsson a été testé pour satisfaire aux exigences des limites d'exposition aux radiofréquences de la FCC/IC dans la (les) configuration(s) d'ordinateur(s) portables(s) munis d'un port USB et peut être utilisé sur des ordinateurs portables dont les dimensions physiques, la fabrication et les caractéristiques électriques et de radiofréquences sont significativement semblables.

Remarque : Si vous prévoyez d'utiliser ce dispositif USB Sony Ericsson sur un autre ordinateur portable, il vous incombe d'obtenir une approbation distincte pour satisfaire aux exigences SAR de l'article 2.1093 de la réglementation FCC.

## Industry Canada Statement

This Class B digital apparatus complies with Canadian ICES-003.

Cet appareil numérique de la classe B est conforme à la norme NMB-003 du Canada.

## RF Exposure Caution Notice

This Mobile Broadband USB Modem, model MD400/MD400g, is approved for use in normal size laptop computers only (typically with 12" or larger display screens). To comply with FCC RF exposure requirements, this modem should not be used in configurations that cannot maintain at least 5 mm (approximately 0.2 inch) on the bottom or 12 mm (approximately 0.5 inch) on the top and sides from users and bystanders. For example, in certain laptop and tablet computers and configurations where the USB connectors on the host computer are unable to provide or ensure the necessary separation between the modem and its users or bystanders to satisfy RF exposure compliance requirements. See Figure 1.

In addition, to maintain RF exposure compliance, the antenna should be rotated completely away (approximately 135 degrees) from the stowed position when operating the USB modem. See Figure 2.

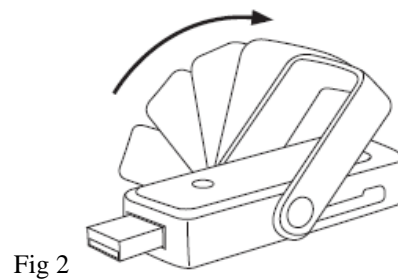
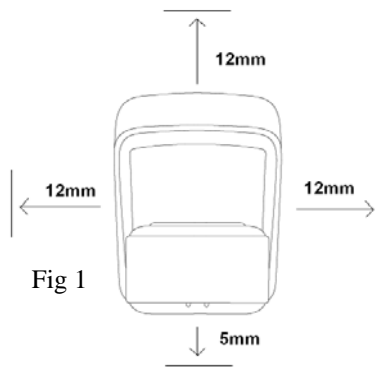



# About this guide

Congratulations and thank you for purchasing a Sony Ericsson MD400 or MD400g Mobile Broadband USB Modem.

This guide includes an overview of the supported features, detailed technical specifications, system requirements, and safety guidelines for both the MD400 and MD400g.

The MD400 and MD400g provide the same features, with one exception, the MD400g incorporates a Global Positional Satellite (GPS) receiver. This manual refers to both modems as MD400. When the information is specific to the MD400g, MD400g will be used.

**Note:**

Be sure to read all safety guidelines in this document before using your MD400.

## How this guide is organised

*Chapter 1: Overview* on page 1, contains an overview of your MD400 and the features that it supports. It also provides a list of the requirements and tools needed to use your new MD400.

*Chapter 2: Additional information* on page 15, provides safety guidelines, warranty information, and regulations that are relevant to your MD400.

*Chapter 3: Technical specifications* on page 20, provides detailed technical specifications for your MD400.

## Additional resources

### Sony Ericsson support Website

Additional resources can be found on the Internet at the Sony Ericsson support Website. You can use the Sony Ericsson Website to find the most up-to-date product information and support wherever you are. It gives you access to online customer services, user manuals, the latest software downloads, and other useful information. For more information, go to:

**[www.sonyericsson.com/support](http://www.sonyericsson.com/support)**

### Publications

Sony Ericsson provides the following documents to help you use your MD400:

- A printed *Quick Start Guide* aimed at getting you operational as quickly as possible.
- A PDF *MD400 User Guide* (this document) that contains a detailed description of your MD400 and the features that it supports. This document is copied to your hard drive when Wireless Manager is installed and can be accessed by selecting **Start ➔ All Programs ➔ Sony Ericsson ➔ Wireless Manager 5 ➔ MD400 User Guide**
- *Online Help* built into Wireless Manager which describes in detail how to use each feature and how to install and uninstall the software. Select Help or press F1 to access online help.

- A PDF *Wireless Manager User Guide* which contains the same detailed information as the online help in a conventional printable format. This document is available from the support website only.

**Note:**

PDF documents are in Adobe® Portable Document Format. If your PC cannot open these documents, download and install the Adobe® Reader® from [www.adobe.com](http://www.adobe.com).

**Note:**

Your mobile operator may provide alternative application software and documentation.

# Overview

## Checklist

The following items should be in the box when you unpack it:

- Sony Ericsson MD400 Mobile Broadband USB Modem
- USB extension cable
- Quick Start Guide (QSG)
- Lanyard and cover (if provided)

## MD400/MD400g Communications Summary

Your MD400 keeps you in touch, enabling you to use the best available mobile service wherever you are. It supports tri-band Universal Mobile Telecommunications System (UMTS) and quad-band Global System for Mobile Communications (GSM):

<b>GSM</b> GPRS EDGE	850MHz 900MHz 1800MHz 1900MHz	<b>UMTS</b> HSPA	850MHz 1900MHz 2100MHz
----------------------------	----------------------------------------	---------------------	------------------------------

Your MD400 supports SMS text messaging and the following communications services:

Service	Maximum Download Speed	Maximum Upload Speed
<b>HSPA</b>	7.2Mb/s	2.0Mb/s
<b>UMTS</b>	384kb/s	384kb/s
<b>EDGE</b>	247.4kb/s	123.7kb/s
<b>GPRS</b>	53.6kb/s (CS-2) 85.6kb/s (CS-4)	26.8kb/s (CS-2) 42.8kb/s (CS-4)

Where UMTS service with HSPA is available, your MD400 can connect at speeds up to 7.2Mb/s. Your MD400 provides automatic fallback to UMTS where HSPA is not available and to EDGE or GPRS service where UMTS is not available (network support required). This section describes the services that the MD400 supports:

- **High Speed Packet Access (HSPA)**

HSPA is an enhancement to UMTS networks. HSDPA (High Speed *Downlink* Packet Access) enables the downlink speed to be dramatically increased; up to 7.2Mbps using the MD400. File downloads will be faster, whilst applications such as video streaming may operate at higher quality and greater reliability. The maximum speed available depends on the configuration of the mobile network, local conditions such as distance to the base station and usage levels. HSUPA (High Speed *Uplink* Packet Access) enables the MD400 to upload data at speeds up to 2.0Mbps.

- **Universal Mobile Telecommunications System (UMTS)**  
UMTS is a 3G technology standard for wide-area wireless data communication that is based on the GSM standard. The UMTS standard uses advanced network operator mobile Internet services to achieve data transfer rates up to 384kbps, which are ideal for media streaming, video MMS, instant shopping, and banking.
- **Enhanced Data Rates for Global Evolution (EDGE)**  
EDGE enhances GPRS by increasing data throughput over GPRS by as much as three times, depending upon the network radio signal strength and quality. GPRS networks that are enhanced with EDGE are often referred to as Enhanced GPRS (E-GPRS) networks. EDGE provides the “always on” capability of GPRS but at faster speeds. EDGE technology is transparent — simply make a GPRS connection as usual and benefit from the increase in speed where EDGE is available in a network. When EDGE is available you can expect increased speeds of up to 200 kb/s, dependent on network coverage.
- **General Packet Radio Service (GPRS)**  
GPRS is a type of network connection that provides “always on” mobility. The connection set up is fast. After you are connected, applications can send and receive data whenever required. In today’s GPRS networks, the MD400 receives data at speeds up to 53.6 kb/s and transmits at speeds up to 26.8 kb/s.
- **Short Message Service (SMS)**  
You can send and receive SMS text messages using the Text Messages window in Wireless Manager or other application software.

## Hardware overview

Your Sony Ericsson MD400 is a USB Mobile Broadband Modem. The MD400 has a retractable USB connector that is covered by the antenna when the modem is not in use. The MD400 has an expandable combo memory slot which accepts either M2 Memory Stick Micro™ or MicroSD™ memory cards. The MD400g contains a GPS receiver.



Before using your MD400, you must extend the USB connector. To do this, move the antenna to the up position, as shown in the following illustration. The USB connector will automatically extend.

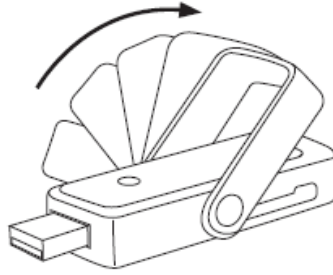

The MD400 uses the 5 volt power supply provided by the USB port. The amount of power that your MD400 draws from the laptop battery depends on several factors, including status, frequency band, distance to the base station that is used, if a memory card is installed and if GPS is enabled (MD400g only).

The MD400 can be turned off under software control from the Wireless Manager application or the signal strength icon in the status tray. You must remove the modem from the laptop when flying to prevent any accidental transmission.

The MD400 has three integrated antennas and a 2-way Diversity receiver for improved downlink performance

### **USB Interface**

The MD400 is a USB2.0 device. USB products that draw more than 100mA from the port are called *high power* devices; the MD400 is a high power device. At maximum transmission power (GSM850/900) it requires peak current of 600mA. Most high power capable USB ports will deliver this current.

The MD400 operates at USB High Speed, 480Mbps, which is more than sufficient to handle the 7.6Mbps download speed supported by the product.

## Status LEDs

The MD400 and MD400g contain multi-colored LEDs that indicate the status of the device. The LEDs are located next to the antenna, as shown below.



LED	Color	Flash rate	Description
1 - GPS (MD400g only)	Yellow	Fast	Searching, position not fixed
	Yellow	Slow	Position fixed
	Off		GPS off
2 - Mobile Service	Red	Fast	Searching for a mobile network
	Green	Medium	Registered to GPRS or EDGE service, not connected
	Green	Slow	Connected - GPRS or EDGE service
	Blue	Medium	Registered to UMTS or HSPA service, not connected
	Blue	Slow	Connected - UMTS or HSPA service

**Note:**

On the MD400 both LEDs are Mobile Service LEDs.

## SIM Card

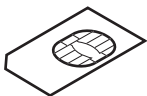

When you subscribe to a mobile network, you are issued a Subscriber Identity Module (SIM) card. Your SIM card contains your personal subscriber data. To connect to a mobile network you must first insert your SIM card, that includes the appropriate network subscription, into your MD400.

### To insert the SIM card

1. Remove the bottom cover from the MD400.

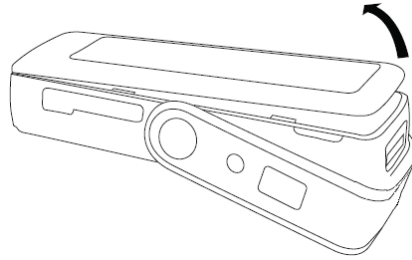

2. Insert the SIM card into the MD400. Make sure the gold contacts on the SIM card are facing towards the MD400 and the angled corner (A) of the SIM card is placed toward the MD400 as shown.



3. Replace bottom cover.

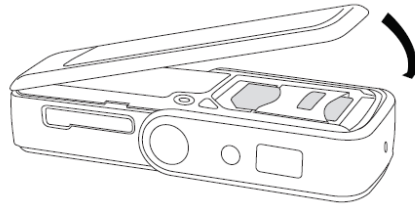

### To remove the SIM card

1. Remove the bottom cover from the MD400.

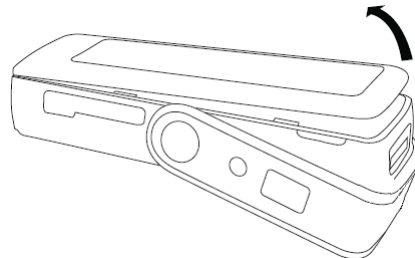

2. Remove the SIM from the MD400.

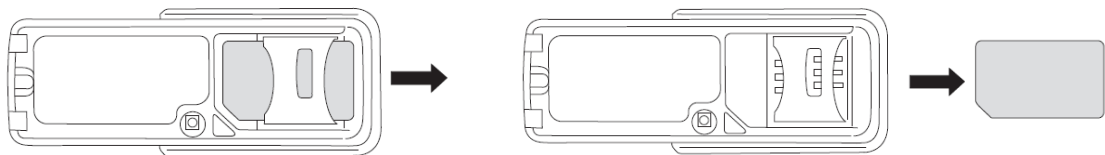

3. Replace the bottom cover.

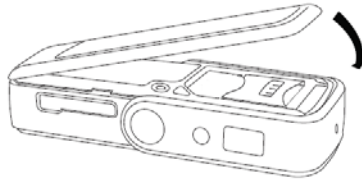

## Attach the Lanyard

The MD400 comes with a lanyard and cover. To attach the lanyard and cover, complete the following steps:

1. Thread the thin end of the lanyard through the small hole in the cover, as shown in the following illustration.

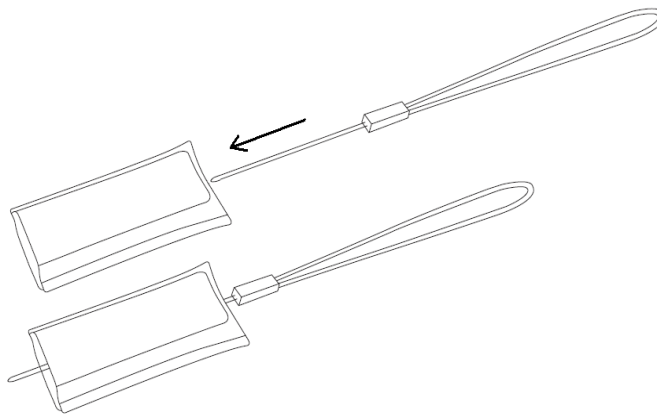

Once the lanyard is threaded through the cover and attached to the MD400, the cover will easily slide over the MD400 for protection or easily slide off for device access.

2. Remove the bottom cover.

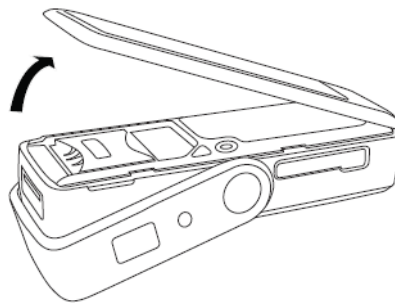



3. Loop the thin end of the lanyard around the plastic hook, as shown.

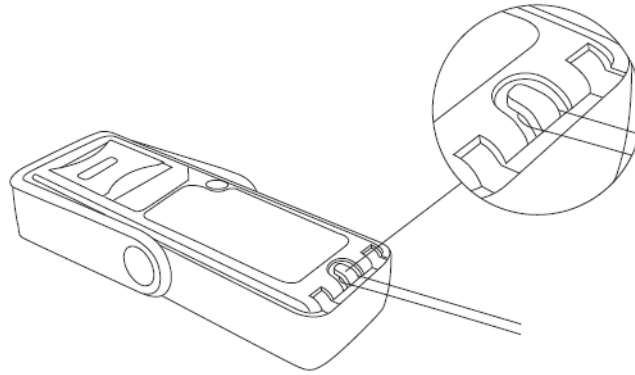

4. Replace cover as shown.

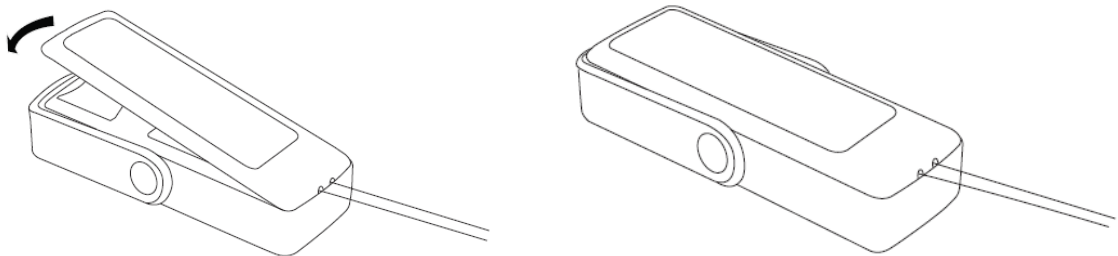

## MD400 memory card slot

The MD400 may be used as a memory card adapter. Optional memory cards may be inserted into the memory card slot, to access your own files and media.

**Note:**

There is no available built-in memory for use as a flash drive in the MD400. Only the optional removable memory card inserted into the combo memory slot is available for use as flash drive memory.

### Removable memory card format

The MD400 has an expandable combo memory card slot which accepts either M2 Memory Stick Micro™ or MicroSD™ memory cards..

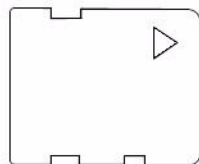

M2 Memory Stick Micro™



MicroSD™ Memory

### To install memory cards

1. Open the small door over the memory slot.

2. Insert the memory card, with the contacts toward the slot, into the slot until it clicks. Install M2 Memory Stick Micro™ with the contacts in the up position. as shown below. Install MicroSD Memory with the contacts in the down position

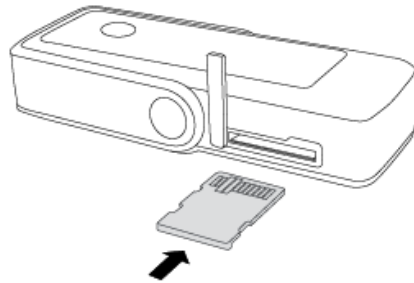

**Note:**

You may require a small tool to recess the memory card into the MD400 Broadband Modem.

3. Replace the door over the memory slot.

**To remove memory card**

1. Open the small door over the memory slot.
2. Push the memory card into the slot until it clicks and release.

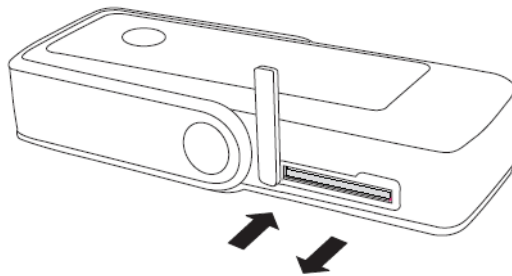

**Note:**

You may require a small tool to push the memory card.

3. Grasp the memory card and remove it from the MD400.
4. Replace the door over the memory slot.

**To access the memory card**

The memory card can be accessed through Windows Explorer. It appears as a removable storage device.

## Antennas

The MD400 has two built-in antennas and the MD400g has an additional GPS antenna.



1. Main - GSM/UMTS/HSPA (transmit and receive)
2. Diversity - UMTS and HSPA (receive only)
3. GPS - Global Positional System (MD400g only) (receive only)

## Global Positioning System

The MD400g Mobile Broadband Modem contains a Global Positioning System (GPS) receiver. GPS is a satellite-based navigation system made up of a network of 32 satellites orbiting the Earth. GPS works anywhere in the world, 24 hours a day.

To access the GPS features of the MD400g, select **View** ➔ **GPS** in *Wireless Manager*. If you are using other software, for example, supplied by your mobile operator, please consult the documentation for that application.

GPS data is provided over the *Sony Ericsson GPS Port*. This is a Windows virtual COM Port. When you install the MD400g, Windows will assign a number, for example COM23. To link a third-party GPS-enabled application to your MD400g's GPS receiver, you may need to access the application settings and select the COM port number that Windows has allocated. This is displayed in the GPS main screen. To view the COM port information select **View** ➔ **GPS**. This information is also available in Device Manager.

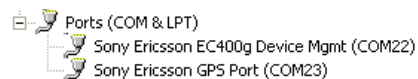

The data that the GPS device provides, is in Nautical Marine Electronics Association (NMEA) format. This format is commonly understood by GPS-enabled applications.

For more information on GPS, refer to your *Wireless Manager User Guide*.

## Network and subscription requirements

The network subscription you use in conjunction with your MD400 depends on the functions and features that are available from your network operator. Contact your network operator or service

provider to make sure the options that you require are available (UMTS/HSPDA, GPRS/EDGE and SMS).

**Note:**

Network operators often provide a number of connectivity options such as WAP and Internet. These are accessed via different APNs (Access Point Names). Verify the services that you require, such as Internet, e-mail or corporate VPN (Virtual Private Network) service are available through your mobile operator and enabled on your subscription.

## Connecting your MD400 to your PC

This section tells you about the different ways you can connect your MD400 to your PC.

- Direct connection
- Extension cable (provided)
- Via a powered hub

**Note:**

Your MD400 must be plugged into a USB port that is capable of supporting high power USB devices. The MD400 is a USB 2.0 product, however it should work in the majority of USB 1.1 ports with possible reduced throughput. Refer to *USB 1.1 and 2.0* on page 12 for more information.

### Direct connection

The MD400 can be plugged directly into a USB port as shown below. This configuration offers the best portability.

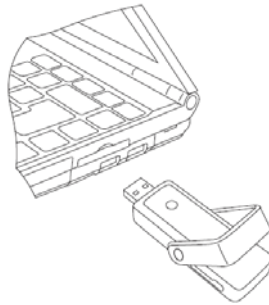

**Note:**

To avoid damage to the MD400 or your laptop's USB port, remove the MD400 before placing your laptop into a carrying case.

**Caution!**

Some laptops have USB port positions that may conflict with operation. Use the included extension cable if:

- The USB ports are close together and the modem covers an adjacent port that is needed.
- The modem can not be plugged in directly, e.g., the USB port is recessed and the USB connector on the modem can not reach.

- The USB port is in a position where physical pressure is put on the connector as shown below.

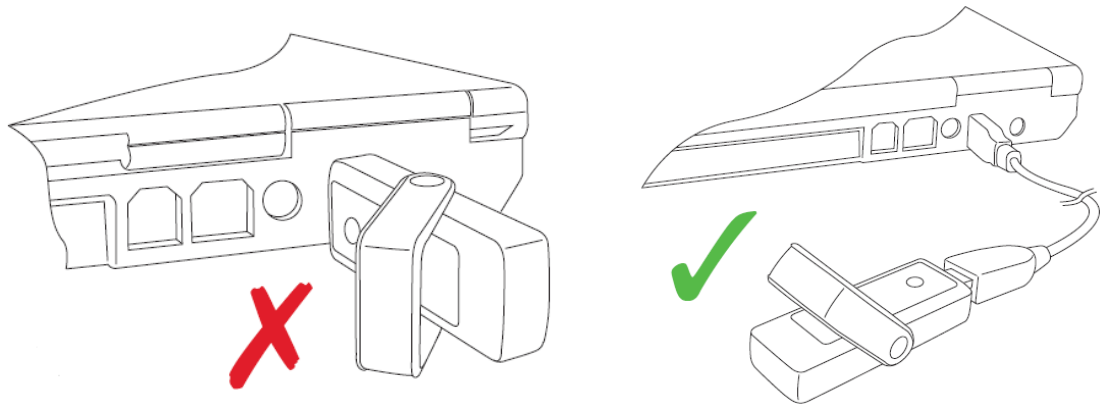

### Extension Cable

The extension cable provided is specially designed to work with your MD400. This is a high quality USB cable that is capable of delivering high current to the MD400 when necessary. Using the cable to distance your MD400 from your laptop will improve data speed/throughput performance.

**Note:**

Your MD400 may not operate correctly if you use a standard USB cable in place of the provided extension cable.

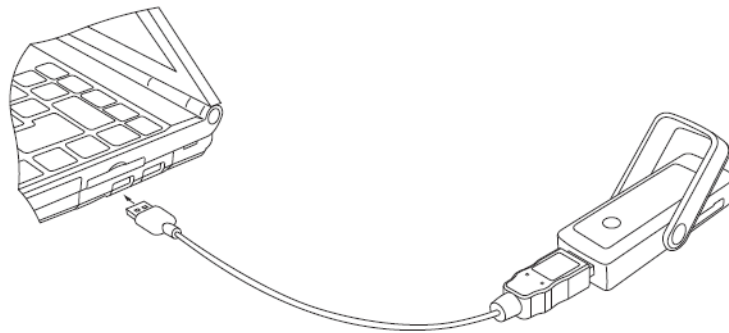

### Powered Hub

A self powered hub (not provided) may be used in conjunction with the extension cable and your MD400. In some cases, especially when used with desktop PCs, it may be necessary to plug the MD400 into a USB hub rather than directly into the PC. This is possible, provided that the hub is self powered via its own AC adaptor.

**Note:**

It is not advisable to use a bus-powered hub with your MD400. These are hubs that have no power supply of their own. Many portable hubs for laptops are of this type.

The MD400 is plugged in using the supplied extension cable or directly into a socket on the hub. The hub configuration allows extended cable length so you can locate the MD400 for optimal reception.

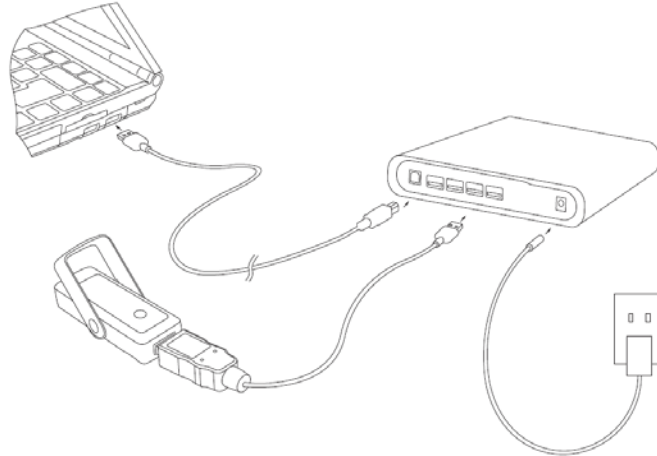

**Note:**

Some powered hubs may not provide adequate power. Your hub must be capable of supporting high power USB devices and must not be overloaded by the connection of too many such devices. Other high power devices include USB-powered disk drives, scanners and rechargeable music players. If you are experiencing problems, unplug these other devices to test if your hub is overloaded.

## USB 1.1 and 2.0

Your MD400 is a USB 2.0 product, however it should work in the majority of USB 1.1 ports, but data throughput may be compromised.

**Note:**

Sony Ericsson does not guarantee operation in a USB 1.1 port

As a guide, USB 1.1 ports are likely to be found in these cases:

- All PCs manufactured before 2002
- All PCs originally sold with Windows 2000 installed
- Current PCs where the USB port is provided only for use with keyboard and mouse.

USB 2.0 ports can be identified in the Device Manager. Select **Start** → **Control Panel** → **System, Hardware Tab, Device Manager**.

The presence of an *Enhanced Host Controller* indicates USB 2.0 support:

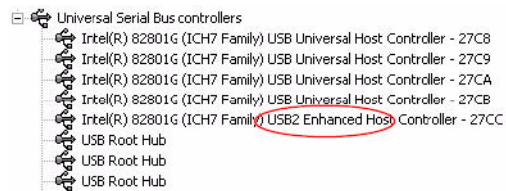

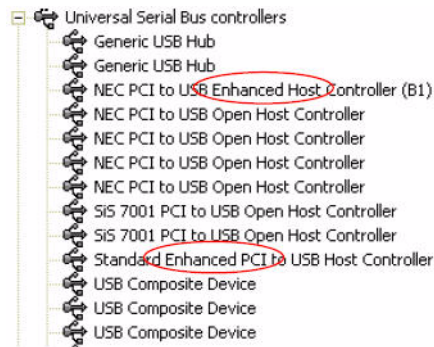

## Software overview

### Sony Ericsson Wireless Manager

Sony Ericsson provides Wireless Manager, an application that provides the ability to configure and manage your wireless connections on your PC. For more information about software requirements, refer to the *Wireless Manager User Guide*.

You can use Wireless Manager to:

- Connect to the Internet or your corporate network
- Display mobile network status information
- Create or modify connection settings
- Manage your MD400 settings and preferences
- Send and receive SMS messages
- Manage phonebooks saved to your SIM card and hard drive
- Enable GPS functionality (MD400g only)
- Access Internet mapping services (MD400g only)

### launch2net - Sony Ericsson Edition

To use your Mobile Broadband USB Modem with your Mac OS X system, you will need "launch2net - Sony Ericsson Edition". This application enables you to set up and use HSPA, UMTS, EDGE, and GPRS connections, subject to network coverage and availability.

You can find the application in one or more of these locations:

- In the OS X folder of the CD-ROM (if provided)
- As a download from <http://www.novamedia.de/sonyericsson> (please check here for latest information and updates)

### Third-party applications

Your network operator or your network administrator may provide an application that works with your MD400. Please refer to the instructions supplied with that application. Functions and features available may be different compared with the Sony Ericsson Wireless Manager application.

## Virtual Private Network (VPN)

Your MD400 is tested for compatibility with popular VPN solutions used by corporations to enable remote workers to access the corporate network.

**Note:**

Sony Ericsson does not provide any VPN software with your MD400.

## System requirements

This section lists the hardware and software requirements for using your MD400.

### General

You will need the following hardware:

- Available USB port capable of supporting high power USB devices
- MD400
- SIM card

### Windows (Wireless Manager)

Wireless Manager works with the following versions of the Windows® operating system:

- Windows 2000 Service Pack 4 (SP4)
- Windows XP Service Pack 2 (SP2); 32-bit (x86) and 64-bit (x64) processors
- Windows Vista™; 32-bit (x86) and 64-bit (x64) processors

Your PC must meet or exceed the minimum system requirements for the installed version of the Windows operating system and have the following:

- 110MB of available disk space

**Note:**

Sony Ericsson periodically releases new versions of Wireless Manager with new features and bugfixes. The exact support for the Windows Operating System may change over time. The readme.txt file included in the download, always identifies which versions and service packs of the Windows operating system are supported. For more information and downloads, please visit [www.sonyericsson.com/support](http://www.sonyericsson.com/support)

### Apple Macintosh

Please refer to the instructions supplied with launch2net or other application software.







# Additional information

## Guidelines for safe and efficient use

Please read this information before using your MD400. 

### Recommendations

- Always treat your product with care and keep it in a clean and dust-free place.
- Do not expose your product to liquid, moisture or humidity.
- Do not expose your product to extreme high or low temperatures. 
- Do not expose your product to open flames or lit tobacco products. 
- Do not drop, throw or try to bend your product.
- Do not paint your product.
- Do not use your product near medical equipment without requesting permission from your treating physician or authorised medical staff.
- Do not use your product when in, or around aircraft, or areas showing the sign “turn off two-way radio”.
- Do not use your product in an area where a potentially explosive atmosphere exists.
- Do not place your product or install wireless equipment in the area above your car’s air bag.
- Do not attempt to disassemble your product. Only Sony Ericsson authorised personnel should perform service. 
- Do not use your laptop while driving. 

### Efficient use

Do not cover the MD400 when in use, as this affects call quality.

### Personal medical devices

Mobile Broadband Modems may affect the operation of cardiac pacemakers and other implanted equipment. If a minimum distance of 15 cm (6 inches) is kept between the MD400 and the pacemaker, the risk of interference is limited. If you have any reason to suspect that interference is taking place, immediately turn off your MD400. Contact your cardiologist for more information.

For other medical devices, please consult your physician and the manufacturer of the device.

### Children

DO NOT ALLOW CHILDREN TO PLAY WITH YOUR MD400. THEY COULD HURT THEMSELVES OR OTHERS, OR COULD ACCIDENTALLY DAMAGE THE MOBILE BROADBAND MODEM. YOUR MOBILE BROADBAND MODEM MAY CONTAIN SMALL PARTS THAT COULD BE DETACHED AND CREATE A CHOKING HAZARD.

## Disposal of old electrical & electronic equipment

This symbol indicates that all electrical and electronic equipment included shall not be treated as household waste. Instead it shall be left at the appropriate collection point for the recycling of electrical and electronic equipment. By ensuring this product is disposed of correctly, you will help prevent potential negative consequences for the environment and human health, which could otherwise be caused by inappropriate waste handling of this product. The recycling of materials will help to conserve natural resources. For more detailed information about recycling of this product, please contact your local city office, your household waste disposal service or the shop where you purchased your MD400.

## Emergency calls

Mobile Broadband Modems manufactured by Sony Ericsson do not support voice calls and should not be relied upon for essential communications.

## Inserting and removing the SIM card – precautions against electrostatic discharge (ESD)

Do not touch the SIM card connectors. As a precaution, always make sure that the MD400 is already in your hand before you insert or remove the SIM card.

## Power Considerations

In almost all cases, the MD400 works correctly when connected to one USB port, either directly or using the supplied extension cable. If you experience the problems listed below, your PC or USB hub may be failing to provide sufficient power to the MD400.

- The MD400 fails to start
- The MD400 is shown as Disabled in Device Manager
- Windows presents a message to say that the device is not operating
- The MD400 malfunctions when a connection is made
- Data transfers frequently stall

## Generic SEMC Limited warranty

### Limited Warranty

Sony Ericsson Mobile Communications AB, Nya Vattentornet, SE-221 88 Lund, Sweden, (Sony Ericsson) or its local affiliated company, provides this Limited Warranty for your mobile phone, original accessory delivered with your mobile phone, and/or your mobile computing product (hereinafter referred to as "Product").

Should your Product need warranty service, please return it to the dealer from whom it was purchased, or contact your local Sony Ericsson Call Center (national rates may apply) or visit [www.sonyericsson.com](http://www.sonyericsson.com) to get further information.

Warranty requirements may differ by country or region. Please visit [www.sonyericsson.com/support](http://www.sonyericsson.com/support) to review the Sony Ericsson warranty applicable to the country or region where you purchased your product, which may differ from the default generic warranty included with your user materials.

### OUR WARRANTY

Subject to the conditions of this Limited Warranty, Sony Ericsson warrants this Product to be free from defects in design, material and workmanship at the time of its original purchase by a consumer. This Limited Warranty will last for a period of one (1) year as from the original date of purchase of the Product.

### WHAT WE WILL DO

If, during the warranty period, this Product fails to operate under normal use and service, due to defects in design, materials or workmanship, Sony Ericsson authorized distributors or service partners, in the country\* where you purchased the Product, will, at their option, either repair or replace the Product in accordance with the terms and conditions stipulated herein.

Sony Ericsson and its service partners reserve the right to charge a handling fee if a returned Product is found not to be under warranty according to the conditions below.

Please note that some of your personal settings, downloads and other information may be lost when your Sony Ericsson Product is repaired or replaced. At present Sony Ericsson may be prevented by applicable law, other regulation or technical restrictions from making a backup copy of certain downloads. Sony Ericsson does not take any responsibility for any lost information of any kind and will not reimburse you for any such loss. You should always make backup copies of all the information stored on your Sony Ericsson Product such as downloads, calendar and contacts before handing in your Sony Ericsson Product for repair or replacement.

### CONDITIONS

1. This Limited Warranty is valid only if the original proof of purchase for this Product issued by a Sony Ericsson authorized dealer specifying the date of purchase and serial number\*\*, is presented with the Product to be repaired or replaced. Sony Ericsson reserves the right to refuse warranty service if this information has been removed or changed after the original purchase of the Product from the dealer.
2. If Sony Ericsson repairs or replaces the Product, the repair for the defect concerned, or the replaced Product shall be warranted for the remaining time of the original warranty period or for ninety (90) days from the date of repair, whichever is longer. Repair or replacement may involve the use of functionally equivalent reconditioned units. Replaced parts or components will become the property of Sony Ericsson.

3. This warranty does not cover any failure of the Product due to normal tear and wear, or due to misuse, including but not limited to use in other than the normal and customary manner, in accordance with the Sony Ericsson instructions for use and maintenance of the Product. Nor does this warranty cover any failure of the Product due to accident, software or hardware modification or adjustment, acts of God or damage resulting from liquid.

A rechargeable battery can be charged and discharged more than a hundred times. However, it will eventually wear out - this is not a defect and corresponds to normal wear and tear. When the talk-time or standby time is noticeably shorter, it is time to replace your battery. Sony Ericsson recommends that you use only batteries and chargers approved by Sony Ericsson.

Minor variations in display brightness and colour may occur between the phones. There may be tiny bright or dark dots on the display. These are called defective pixels and occur when individual dots have malfunctioned and can not be adjusted. Two defective pixels are deemed acceptable.

Minor variations in camera image appearance may occur between phones. This is nothing uncommon and is not regarded as a defective camera module.

4. Since the cellular system on which the Product is to operate is provided by a carrier independent from Sony Ericsson, Sony Ericsson will not be responsible for the operation, availability, coverage, services or range of that system.
5. This warranty does not cover Product failures caused by installations, modifications, or repair or opening of the Product performed by a non-Sony Ericsson authorised person.
6. The warranty does not cover Product failures which have been caused by use of accessories or other peripheral devices which are not Sony Ericsson branded original accessories intended for use with the Product.
7. Tampering with any of the seals on the Product will void the warranty.
8. THERE ARE NO EXPRESS WARRANTIES, WHETHER WRITTEN OR ORAL, OTHER THAN THIS PRINTED LIMITED WARRANTY. ALL IMPLIED WARRANTIES, INCLUDING WITHOUT LIMITATION THE IMPLIED WARRANTIES OF MERCHANTABILITY OR FITNESS FOR A PARTICULAR PURPOSE, ARE LIMITED TO THE DURATION OF THIS LIMITED WARRANTY. IN NO EVENT SHALL Sony Ericsson OR ITS LICENSORS BE LIABLE FOR INCIDENTAL OR CONSEQUENTIAL DAMAGES OF ANY NATURE WHATSOEVER, INCLUDING BUT NOT LIMITED TO LOST PROFITS OR COMMERCIAL LOSS; TO THE FULL EXTENT THOSE DAMAGES CAN BE DISCLAIMED BY LAW.

Some countries/states do not allow the exclusion or limitation of incidental or consequential damages, or limitation of the duration of implied warranties, so the preceding limitations or exclusions may not apply to you.

The warranty provided does not affect the consumer's statutory rights under applicable legislation in force, nor the consumer's rights against the dealer arising from their sales / purchase contract.

#### \*GEOGRAPHICAL SCOPE OF THE WARRANTY

If you have purchased your Product in a country member of the European Economic Area (EEA) or in Switzerland or the Republic of Turkey, and such Product was intended for sale in the EEA or in Switzerland or in Turkey, you can have your Product serviced in any EEA country or in Switzerland or in Turkey, under the warranty conditions prevailing in the country in which you require servicing, provided that an identical Product is sold in such country by an authorised Sony Ericsson distributor.

To find out if your Product is sold in the country you are in, please call the local Sony Ericsson Call Center. Please observe that certain services may not be possible elsewhere than in the country of original purchase, for example due to the fact that your Product may have an interior or exterior which is different from equivalent models sold in other countries. Please note in addition that it may sometimes not be possible to repair SIM-locked Products.

\*\* In some countries/regions additional information (such as a valid warranty card) may be requested.

# Technical specifications

## General

<b>Product name</b>	<b>MD400</b>
<b>System</b>	GSM 850 E-GSM 900 GSM 1800 GSM 1900 UMTS 850 (band V) UMTS 1900 (band II) UMTS 2100 (band I)
<b>USB Device Type</b>	USB 2.0, High Speed USB Device
<b>Services supported</b>	GSM: GPRS/EDGE, SMS, USSD UMTS: Packet-Switched, HSDPA, HSUPA, Circuit-Switched, SMS, USSD Speech services are not supported GPS Positioning (MD400g only)
<b>SIM Card</b>	Small plug-in card, 3V and 1.8V type Regular (non-GPRS-aware) and GPRS-aware SIMs supported USIM
<b>MD400 Type Number</b>	FAD-3232022-BV
<b>MD400g Type Number</b>	FAD-3232023-BV
<b>MD400 FCC ID</b>	PY7F3232022
<b>MD400g FCC ID</b>	PY7F3232023
<b>MD400 IC</b>	4170B-F3232022
<b>MD400g IC</b>	4170B-F3232023
<b>Industry Canada Statement</b>	This Class B digital apparatus complies with Canadian ICES-003.

## Exterior description

<b>Size</b>	<b>Length:</b> 70mm <b>Width:</b> 28mm <b>Height:</b> 15mm
<b>Weight</b>	MD400 and MD400g: 33.5 grams, excluding SIM card
<b>Battery</b>	Powered via the USB port.
<b>Antenna</b>	GSM/UMTS antenna (Main) GPS antenna (MD400g only) Diversity (HSPA)

## Ambient temperatures

<b>Operating</b>	-10 to 55 degrees C
<b>Storage</b>	-20 to 65 degrees C

## Environmental Compliance

<b>Directives</b>	WEEE (Waste Electrical and Electronic Equipment Directive) RoHS (Restriction of use of certain Hazardous Substances)
-------------------	-------------------------------------------------------------------------------------------------------------------------

## Application support

<b>Windows</b>	Sony Ericsson Wireless Manager Third-party software that might be provided by your mobile operator
<b>Apple Macintosh</b>	launch2net - Sony Ericsson Edition Third-party software that might be provided by your mobile operator

## Electrical characteristics

<b>Nominal operating voltage</b>	5V
<b>Average Idle Power (GPRS attached)</b>	<500mW
<b>Data Transfer Power (Worst case with GPS enabled)</b>	<4.0W

### Note:

All power consumptions are at nominal voltage.

## GSM performance and technical characteristics

<b>Dimension</b>	<b>Modulation</b>	<b>Power classes</b>
<b>GSM 850</b>	GMSK/8-PSK	Class 4 (2W) for GSM/GPRS and EGPRS/MCS 1-4 (GMSK); Class E2 (0.5W) for EGPRS/MCS 5-9 (8-PSK)
<b>GSM 900 E-GSM 900</b>	GMSK/8-PSK	Class 4 (2W) for GSM/GPRS and EGPRS/MCS 1-4 (GMSK); Class E2 (0.5W) for EGPRS/MCS 5-9 (8-PSK)
<b>GSM 1800</b>	GMSK/8-PSK	Class 1 (1W) for GSM/GPRS and EGPRS/MCS 1-4 (GMSK); Class E2 (0.4W) for EGPRS/MCS 5-9 (8-PSK)
<b>GSM 1900</b>	GMSK/8-PSK	Class 1 (1W) for GSM/GPRS and EGPRS/MCS 1-4 (GMSK); Class E2 (0.4W) for EGPRS/MCS 5-9 (8-PSK)

## GSM features supported

<b>ME SIM Lock</b>	Network Network Subset Service Provider Corporate
<b>Online services (SIM-AT)</b>	Supported (R99)
<b>USIM Application Toolkit</b>	Supported
<b>USSD</b>	Phase 2+ Support is provided via AT commands; No MMI is provided

## GPRS technical data

<b>Data Rates</b>	Multislot class 10 supported (see table below). Coding schemes: CS-1, CS-2, CS-3 and CS-4
<b>Mode of Operation</b>	Class B (attaches to both GSM and GPRS at the same time).
<b>IP Connectivity</b>	PDP type IP is supported IPv4
<b>SMS over GPRS</b>	Mobile Originated and Mobile Terminated
<b>Compression</b>	TCP/IP Header Compression (RFC1144 and RFC 2507) V42bis
<b>GPRS Encryption</b>	GEA1 and GEA2
<b>GPRS IP allocation</b>	Dynamic Static

## GPRS maximum data rates

		<b>CS-1</b> <b>9.05 kb/s</b>	<b>CS-2</b> <b>13.4 kb/s</b>	<b>CS-3</b> <b>15.6 kb/s</b>	<b>CS-4</b> <b>21.4 kb/s</b>
<b>4 + 1</b>	<b>RX</b>	36.2	53.6	62.4	85.6
	<b>TX</b>	9.05	13.4	15.6	21.4
<b>3 + 2</b>	<b>RX</b>	27.15	40.2	46.8	64.2
	<b>TX</b>	18.1	26.8	31.2	42.8

Speed achieved depends on the Coding Scheme supported by the GSM network. The speeds given are maxima. Sony Ericsson cannot guarantee the speed at which your network will operate.

Data rate is the payload per slot: header plus data.



## EDGE technical data

<b>Device class</b>	EDGE Class 10
<b>Modulation Coding Schemes</b>	MCS-1 to MCS-9
<b>EDGE features</b>	Link Adaptation Incremental Redundancy Extended Uplink Temporary Block Flow (TBF) Network Assisted Cell Change (NACC)

## EDGE maximum data rates

Coding scheme	Data rate per slot	4 + 1		3 + 2	
		Rx	Tx	Rx	Tx
<b>MCS-1</b>	<b>10.60</b>	42.40	10.60	31.80	21.20
<b>MCS-2</b>	<b>13.00</b>	52.00	13.00	39.00	26.00
<b>MCS-3</b>	<b>16.60</b>	66.40	16.60	49.80	33.20
<b>MCS-4</b>	<b>19.40</b>	77.60	19.40	58.20	38.80
<b>MCS-5</b>	<b>24.05</b>	96.20	24.05	72.15	48.10
<b>MCS-6</b>	<b>31.25</b>	125.00	31.25	93.75	62.50
<b>MCS-7</b>	<b>47.45</b>	189.80	47.45	142.35	94.90
<b>MCS-8</b>	<b>57.05</b>	228.20	57.05	171.15	114.10
<b>MCS-9</b>	<b>61.85</b>	247.40	61.85	185.55	123.70

Speed achieved depends on the Coding scheme supported by the GSM Network. The speeds given are maxima, Sony Ericsson cannot guarantee the speed at which your network will operate.

Data rate is the payload per slot: header plus data.

## UMTS technical data

<b>Power class</b>	Class 3 (0.25W, 24dBm)
<b>Maximum Downlink speed</b>	384kb/s
<b>Maximum Uplink speed</b>	384kb/s
<b>UMTS features</b>	Inter-Mode Handover (UMTS/EDGE/GPRS) Inter-Mode Re-selection (UMTS/EDGE/GPRS)
<b>Quality Of Service</b>	UMTS classes supported via AT Command
<b>Modes</b>	PDP type IP is supported IPv4
<b>IP Allocation</b>	Static, Dynamic
<b>R4 Enhancements</b>	Extended TBF Uplink Network Assisted Cell Change (NACC)

## HSPA technical data

<b>Maximum Downlink speed</b>	7.2Mb/s
<b>HSPA Categories</b>	1-8, 11, 12

## HSUPA technical data

<b>Maximum Uplink speed</b>	2.0Mb/s
<b>HSUPA Categories</b>	4 (10ms) and 5

## SMS Technical Data

<b>Concatenated SMS</b>	Supported in Wireless Manager or via third party software
<b>SMS Cell Broadcast</b>	Supported via AT Commands.
<b>SMS interface</b>	Wireless Manager. AT Command.

## Firmware upgrade

<b>MD400 firmware upgrade</b>	Via secure Internet download using the Sony Ericsson Update Service, <a href="http://www.sonyericsson.com/support">www.sonyericsson.com/support</a> or at Sony Ericsson Service Points
-------------------------------	----------------------------------------------------------------------------------------------------------------------------------------------------------------------------------------

## Software upgrade

<b>Wireless Manager Upgrade</b>	Internet download
---------------------------------	-------------------

## GPS specifications.

<b>Specification</b>		<b>Description</b>
Interface		USB virtual COM port
Protocol		NMEA 0183 v2.0
Port access		Simultaneous port open for multiple GPS applications.
Channels		8 hardware channels Up to 20 satellite tracking via software channels
Antennas		Built-in GPS antenna.
Receiver modes		Standalone Assisted Start
Performance	Standalone	Cold start TTFF < 60 seconds @ -130dBm Hot start TTFF < 10s @ -130dBm
	Assisted Start	Cold start TTFF < 10s @ -130dBm Hot start TTFF < 10s @ -130dBm Cold start TTFF < 60s @ -150dBm

## Flash Memory Card.

Specification	Description
Type	M2 Memory Stick Micro™ MicroSD™
Max size	32 GB

# Index

## A

- antenna 9
- Apple
  - Mac OS X 13

## C

- Communications summary 1
- Configurations 10
  - direct USB connection 10
  - powered hub 11
- Connecting your PC400 10

## D

- declaration of conformity v

## E

- EDGE
  - definition 2
  - maximum data rates 23
  - technical data 23

## F

- FCC vi, vii
- firmware 24
- firmware upgrade 24

## G

- GPRS
  - definition 2
  - maximum data rates 22
  - technical data 22
- GPS 9
- GSM
  - features supported 22
  - performance 21
- guidelines
  - children 15
  - overview 15
  - personal medical devices 15
  - recommendations 15
  - SIM handling 16

## H

- hardware
  - overview 3
  - requirements 14
  - SIM card 4
- HSDPA
  - technical data 24
- HSPA
  - definition 1

## I

- Internet 24

## L

- Lanyard
  - install 6
- launch2net – Sony Ericsson Edition 13
- LEDs
  - status 4

## M

- Memory card
  - access 8
  - format 7
  - install 7
  - removal 8
  - slot 7
- Mobile Broadband Modem
  - disposal of 16

## N

- network
  - requirements 9

## P

- packaging, checklist 1, 7
- personal medical devices, guidelines 15

## R

- requirements
  - hardware 14
  - network and subscription 9

## **S**

- SIM card 4
  - guidelines 16
- SMS
  - definition 2
  - technical data 24
- software
  - Apple Macintosh 13
  - launch2net – Sony Ericsson Edition 13
  - overview 13
  - third-party applications 13
  - Wireless Manager 13
- specifications 20
- support
  - Sony Ericsson Website ix

## **T**

- technical specifications 20
- third-party applications 13

## **U**

- UMTS
  - definition 2
  - technical data 23
- USB
  - 1.1 and 2.0 12
  - Interface 3

## **V**

- VPN 14

## **W**

- warranty
  - limited 17
- Wireless Manager
  - description 13

## Free Manuals Download Website

<http://myh66.com>

<http://usermanuals.us>

<http://www.somanuals.com>

<http://www.4manuals.cc>

<http://www.manual-lib.com>

<http://www.404manual.com>

<http://www.luxmanual.com>

<http://aubethermostatmanual.com>

Golf course search by state

<http://golfingnear.com>

Email search by domain

<http://emailbydomain.com>

Auto manuals search

<http://auto.somanuals.com>

TV manuals search

<http://tv.somanuals.com>