

TASCAM

TEAC Professional Division

D00890300A

CD-DJ1

PORTABLE DJ CD/MP3 PLAYER

OWNER'S MANUAL

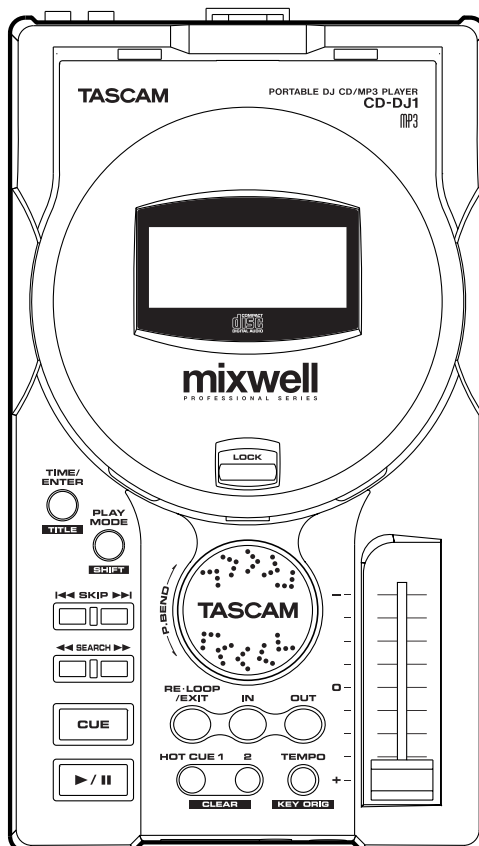

IMPORTANT SAFETY PRECAUTIONS



CAUTION: TO REDUCE THE RISK OF ELECTRIC SHOCK, DO NOT REMOVE COVER (OR BACK). NO USER-SERVICEABLE PARTS INSIDE. REFER SERVICING TO QUALIFIED SERVICE PERSONNEL.



The lightning flash with arrowhead symbol, within equilateral triangle, is intended to alert the user to the presence of uninsulated "dangerous voltage" within the product's enclosure that may be of sufficient magnitude to constitute a risk of electric shock to persons.



The exclamation point within an equilateral triangle is intended to alert the user to the presence of important operating and maintenance (servicing) instructions in the literature accompanying the appliance.

This appliance has a serial number located on the rear panel. Please record the model number and serial number and retain them for your records.

Model number _____

Serial number _____

WARNING: TO PREVENT FIRE OR SHOCK HAZARD, DO NOT EXPOSE THIS APPLIANCE TO RAIN OR MOISTURE.

For U.S.A.

TO THE USER

This equipment has been tested and found to comply with the limits for a Class B digital device, pursuant to Part 15 of the FCC Rules. These limits are designed to provide reasonable protection against harmful interference in a residential installation. This equipment generates, uses, and can radiate radio frequency energy and, if not installed and used in accordance with the instruction manual, may cause harmful interference to radio communications.

However, there is no guarantee that interference will not occur in a particular installation. If this equipment does cause harmful interference to radio or television reception, which can be determined by turning the equipment off and on, the user is encouraged to try to correct the interference by one or more of the following measures.

- a) Reorient or relocate the receiving antenna.
- b) Increase the separation between the equipment and receiver.
- c) Connect the equipment into an outlet on a circuit different from that to which the receiver is connected.
- d) Consult the dealer or an experienced radio/TV technician for help.

CAUTION

Changes or modifications to this equipment not expressly approved by TEAC CORPORATION for compliance could void the user's authority to operate this equipment.

IMPORTANT SAFETY INSTRUCTIONS

- 1 Read these instructions.
- 2 Keep these instructions.
- 3 Heed all warnings.
- 4 Follow all instructions.
- 5 Do not use this apparatus near water.
- 6 Clean only with dry cloth.
- 7 Do not block any ventilation openings. Install in accordance with the manufacturer's instructions.
- 8 Do not install near any heat sources such as radiators, heat registers, stoves, or other apparatus (including amplifiers) that produce heat.
- 9 Do not defeat the safety purpose of the polarized or grounding-type plug. A polarized plug has two blades with one wider than the other. A grounding type plug has two blades and a third grounding prong. The wide blade or the third prong are provided for your safety. If the provided plug does not fit into your outlet, consult an electrician for replacement of the obsolete outlet.
- 10 Protect the power cord from being walked on or pinched particularly at plugs, convenience receptacles, and the point where they exit from the apparatus.
- 11 Only use attachments/accessories specified by the manufacturer.
- 12 Use only with the cart, stand, tripod, bracket, or table specified by the manufacturer, or sold with the apparatus. When a cart is used, use caution when moving the cart/apparatus combination to avoid injury from tip-over.
- 13 Unplug this apparatus during lightning storms or when unused for long periods of time.
- 14 Refer all servicing to qualified service personnel. Servicing is required when the apparatus has been damaged in any way, such as power-supply cord or plug is damaged, liquid has been spilled or objects have fallen into the apparatus, the apparatus has been exposed to rain or moisture, does not operate normally, or has been dropped.
 - Do not expose this apparatus to drips or splashes.
 - Do not place any objects filled with liquids, such as vases, on the apparatus.
 - Do not install this apparatus in a confined space such as a bookcase or similar unit.
 - The apparatus draws nominal non-operating power from the AC outlet with its POWER switch in the off position.
 - The apparatus should be located close enough to the AC outlet so that you can easily grasp the power cord plug at any time.
 - An apparatus with Class I construction shall be connected to an AC outlet with a protective grounding connection.



- 13 Unplug this apparatus during lightning storms or when unused for long periods of time.

IMPORTANT SAFETY INSTRUCTIONS

This product has been designed and manufactured according to FDA regulations "title 21, CFR, chapter 1, subchapter J, based on the Radiation Control for Health and Safety Act of 1968", and is classified as a class 1 laser product. There is no hazardous invisible laser radiation during operation because invisible laser radiation emitted inside of this product is completely confined in the protective housings.

The label required in this regulation is shown at ①.

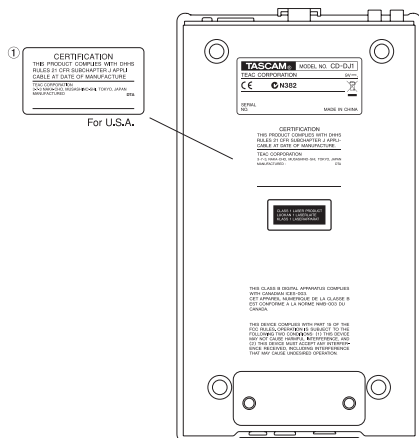

CAUTION

- DO NOT REMOVE THE PROTECTIVE HOUSING USING A SCREWDRIVER.
- USE OF CONTROLS OR ADJUSTMENTS OR PERFORMANCE OF PROCEDURES OTHER THAN THOSE SPECIFIED HEREIN MAY RESULT IN HAZARDOUS RADIATION EXPOSURE.
- IF THIS PRODUCT DEVELOPS TROUBLE, CONTACT YOUR NEAREST QUALIFIED SERVICE PERSONNEL, AND DO NOT USE THE PRODUCT IN ITS DAMAGED STATE.

Optical pickup:

Type: KSM-900AAA
Manufacturer: SONY Corporation
Laser output: Less than 1 mW play on the objective lens
Wavelength: 775 to 816 nm

1- Introduction	6	Setting the IN point.....	17
Supplied accessories.....	6	Setting the OUT point.....	17
Precautions and notes for placement and use	7	Canceling loop playback	17
Beware of condensation.....	7	Re-loop playback	18
Power supply	7	Canceling loop points	18
Sleep function.....	7	Changing the OUT point.....	18
Handling of compact discs.....	8	HALF	18
About this manual.....	8	SET.....	18
		Adjusting the OUT point.....	18
		Restoring the OUT point.....	18
2- Features of the CD-DJ1	9	Tempo control.....	18
Top panel.....	9	Setting the tempo range	18
Front panel.....	11	Key Original function	19
Rear panel	11	Pitch bend function	19
Display.....	11	When set to SRCH.....	19
The "home" screen	11	When set to BEND	19
Setup screen	12		
3- Setup menu	13	6- MP3 playback	20
Setup menu operation	13	Playback range selection.....	20
Menu configuration	13	Folder selection	20
4- Playback operations.....	14	Display indication	20
Discs for playback.....	14	Functions disabled during MP3 playback	20
Playback modes	14	MP3 file folders and tracks	21
Basic operation	14		
Track selection	14	7- Other features.....	22
Track search.....	15	TT-M1 use.....	22
Auto Cue	15	Turning the TT-M1 on and off	22
Auto Ready	15	TT-M1 Calibration.....	22
CD text data display.....	15	Functions disabled during TT-M1 use	22
5- DJ functions.....	16	Resetting the unit.....	22
Cue.....	16	Setting output volume.....	23
Setting the cue point	16	Auto Play	23
Play mode.....	16	Adjusting the backlight.....	23
Cue mode	16	Adjusting the contrast	23
Using and confirming the cue point	16		
Hot Cue	16	8- Specifications	24
Setting Hot Cue points.....	16	Specifications.....	24
Canceling Hot Cue points	17	Audio performance	24
Using and confirming Hot Cue points	17	Backup memory.....	25
Flash Start	17	Setup menu settings (all except for the system reset parameter).....	25
Loop playback.....	17	Other settings.....	25
		Dimensional drawing	25

1- Introduction

Thank you for purchasing the TASCAM CD-DJ1. This DJ-use CD player is portable, compact and user-friendly.

Please study this manual thoroughly before using the player to ensure that you understand how to use it properly. We hope that with this knowledge you will enjoy using the CD-DJ1 and all of its features for many years. After you have finished reading this manual, please keep it in a safe place for future reference.

Main Features of the CD-DJ1

- The CD-DJ1 is compact, lightweight and highly portable, making it easy to set up in DJ booths and other tight spaces.
- The CD-DJ1 can play audio CD-Rs and CD-RWs as well as commercially available audio CDs. In addition, the CD-DJ1 can play MP3 files.
- Anti-shock memory that is effective for at least 7 seconds allows the CD-DJ1 to output sound continuously even in clubs and other environments with heavy vibrations.
- The CD-DJ1 has a large easy-to-push PLAY/PAUSE key as well as separate SEARCH and SKIP keys.
- The CD-DJ1 has multiple cueing functions, including 2 HOT CUE keys and a regular CUE key.
- Instant play capability allows immediate playback start from a paused state.
- The CD-DJ1 has the 60-mm tempo slider with adjustable tempo range.
- The JOG dial can be used for pitch bend, frame search, and menu operation.

- The Key Original function makes it possible to maintain the same pitch while changing the playback tempo.
- CD playback can be controlled with an analog turntable by attaching a TASCAM TT-M1 (sold separately) to the CD-DJ1.
- The 4 playback modes include all tracks, single-track, all track repeat and single-track repeat.
- Seamless loop playback between any two points is possible.
- For MP3 files, either all tracks in a single folder or all tracks in all folders can be selected for play.
- The CD-DJ1 has Auto Cue and Auto Ready functions.
- The Auto Play function allows automatic playback after the power is turned on.
- The display not only shows the status of the CD-DJ1 and the loaded disc, but can also show CD text data and MP3 file titles.
- The backlight brightness and display contrast can be adjusted.
- The Setup menu allows a variety of functions to be customized.
- The Sleep function automatically stops the CD mechanism and turns off the backlight if the unit is unused for 30 minutes.

Supplied accessories

In addition to this manual, this product includes the following items:

- CD-DJ1 unit 1
- AC adapter (PS-PS5) 1

Please use caution when removing the main unit from the package to avoid damage or injury. Please keep the box and packaging materials for future transportation.

If any of the accessory items are missing, please contact your TASCAM supplier.

Precautions and notes for placement and use

Please use the CD-DJ1 only within its operating temperature range of 5°C to 35°C (41°F to 95°F). Please avoid use or storage in dusty or humid environments because these conditions can cause malfunction.

To maintain top performance, and prolong operating life, observe the following notes, precautions and environmental conditions:

- Avoid exposing it to extremes of temperature and humidity and avoid mechanical shocks.
- Keep the unit away from strong magnetic fields (TV sets, computer monitors, large electric motors, etc.).
- Relative humidity should be 30 to 90 percent.
- As the unit may become hot during operation, always leave sufficient space above the unit for ventilation. Do not operate this unit in a confined space such as a bookcase, and do not put anything on top of the unit.

- Avoid placing this unit on top of any heat-generating electrical device such as a power amplifier.
- Always use the supplied AC adapter (PS-PS5) with the standard home electrical power outlet. Use of other AC adapters may damage the CD-DJ1.
- Use the unit on a table or rack that is level and sturdy.
- Wipe dirt from the unit with a dry cloth. Never use thinner, benzene or other solvents because they may cause acrylic parts and coated surfaces to dissolve, labels to be eroded or other damage.

Beware of condensation

If the unit (or a compact disc) is moved from a cold to a warm place, or used after a sudden temperature change, there is a danger of condensation; vapor in

the air could condense on the internal mechanism, making correct operation impossible.

Power supply

Attach the DC plug of the supplied AC adapter to the **DC IN** jack on the rear panel and connect the power plug to a standard electrical power outlet.

Pressing the **POWER** switch on the rear panel lights up the display. After a brief start-up screen, the home screen will appear.

Sleep function

If playback is paused and the unit has not been used for 30 minutes, the unit will automatically go to sleep, stopping the CD mechanism and turning off the backlight.

1- Introduction

Handling of compact discs

The CD-DJ1 has been designed for the playback of CD-DA (standard audio) format discs and MP3 files recorded on the discs using the ISO9660 format. In addition to ordinary 12cm (5-inch) and 8cm (3-inch) CDs, it can also play properly recorded CD-Rs and CD-RWs.

- Always place the compact discs in the trays with their label facing upward.
- To remove a disc from its case, press down on the center of the disc holder, then lift the disc out, holding it carefully by the edges.



- Avoid getting fingerprints on the signal side (the non-label side). Grime and dust may cause skipping, so keep discs clean and store them in their cases when not being played. To clean the signal side of a disc, wipe gently with a soft dry cloth from the center towards the outside edge.



- Do not use any record spray, anti-static solutions, benzene, paint thinner or other chemical agents to clean CDs as they could damage the delicate playing surface. It may cause CDs to become unplayable.
- Discs should be returned to their cases after use to avoid serious scratches that could cause the laser pickup to “skip.”

- Keep discs away from direct sunlight, and places of high heat and humidity. If left in such places, warping could result.
- Do not affix any labels or stickers to the label side of the disc. Do not write on the disc with a ball-point pen.
- Do not insert discs that have adhesive remaining from tape or stickers that have been removed. If they are inserted into the player, they could stick to the internal mechanism, requiring removal by a technician.
- Do not use cracked discs.
- Only use circular compact discs. Avoid using non-circular promotional, etc. discs.

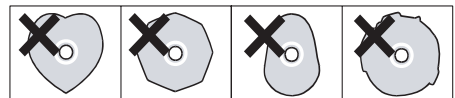

- The CD-DJ1 cannot play unfinalized CD-R/RWs.
- The unit may not be able to play some CD-Rs and CD-RWs due to disc quality or recording conditions.
- Music discs with copy control, a copy-protection system, have been released from several record companies in an attempt to protect the copyright. Since some of these discs do not comply with the CD specifications, they may not be playable on the CD-DJ1.

About this manual

In this manual, we use the following conventions:

- The names of keys and controls are given in the following typeface: **TEMPO**.
- When the alphanumeric portion of the display shows a message, this is shown in the following typeface: **NO DISC**.

- If a preset indicator in the display (i.e. one which cannot change, but is either on or off) is shown, this is shown as follows: **REMAIN**.

2- Features of the CD-DJ1

Top panel

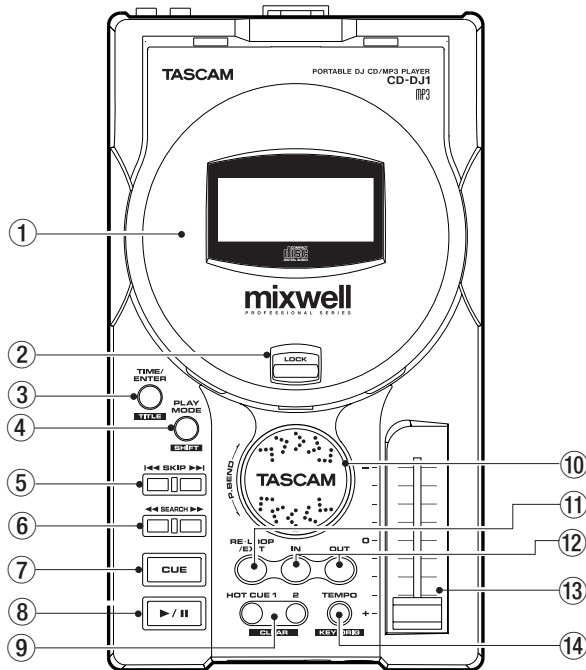

① **CD cover** To open the CD cover, lift the cover from the indentations on the sides of the unit. When a disc is loaded and the CD cover is closed, the CD-DJ1 will read the disc information (TOC). After reading is complete, the unit will pause.

② **Lock lever** When the CD cover is closed, pulling this lever down shows the **LOCK** label, indicating that the CD cover cannot be opened. Pushing the lever up shows the **UNLOCK** label, indicating that the CD cover can be opened.

CAUTION

*Please set the lever to **LOCK** when moving the unit to prevent the disc from falling out.*

③ **TIME/ENTER and TITLE key** When the home screen is displayed, pressing this key cycles through the playback time display modes in the following order: **ELAPSED** (track time elapsed) → **REMAIN** (track time remaining) → **TOTAL REMAIN** (disc time remaining).

NOTE

***ELAPSED** (track time elapsed) is the only usable time display mode for MP3 playback. **REMAIN** and **TOTAL REMAIN** modes cannot be used.*

When using the Setup menu, this key becomes the **ENTER** key.

Pressing this key while holding down the **SHIFT** key will cycle through CD text data or MP3 file title information.

④ **PLAY MODE and SHIFT key** Pressing this key cycles through the playback modes in the following order: Continuous playback of all tracks (default setting) → Single-track playback → Repeat playback (all tracks) → Single-track repeat playback.

This key acts as the **SHIFT** key when held down with other keys. When used this way, the playback mode will not be changed.

⑤ **SKIP (◀◀/▶▶) keys** These allow track selection both during playback and while the CD is paused. For more information, please see “Track selection” on page 14.

During MP3 file playback, pressing this key while holding down the **SHIFT** key will select folders (see “Folder selection” on page 20).

⑥ **SEARCH (◀◀/▶▶) keys** Search tracks, or pitch bend a track when set to **BEND** using **SRCH KEY** setting in the Setup menu (see “Setup menu” on page 13).

2- Features of the CD-DJ1

When set to **SRCH**, pressing these keys searches through the tracks backward and forward in both playback and pause mode (see “Track search” on page 15).

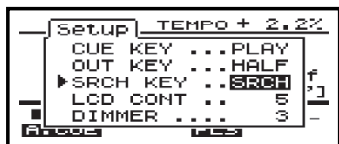

When set to **BEND**, these keys cause pitch bend. During playback, holding down a **SEARCH** key changes the tempo. When the keys are released, the tempo will return to its original state (see “Pitch bend function” on page 19).

By holding down the **SHIFT** key, pitch bend will occur regardless of the **SRCH KEY** setting.

- ⑦ **CUE key** When a cue point is set, pressing this key pauses the CD playback at the cue point (Cue Pause). During cue pause, holding down the **CUE** key for temporary playback. When the key is released, the CD will pause again at the cue point (Cue Pause).

If the **PLAY/PAUSE** key is pressed while the **CUE** key is pressed, normal playback mode will resume (see “Cue” on page 16).

The **CUE** key is also used to save cue points.

If the **CUE** key is pressed while the **SHIFT** key is held down, the **CUE** mode will be changed (see “Cue” on page 16).

- ⑧ **▶/|| (PLAY/PAUSE) key** When the unit is paused, pressing this key starts playback. If pressed during playback, the unit will pause. This key lights during playback, and blinks while paused.
If this key is pressed while the **SHIFT** key is held down, TT-M1 calibration will start (see “TT-M1 Calibration” on page 22).
- ⑨ **HOT CUE (1, 2) / CLEAR keys** If a Hot Cue point has not been set for a **HOT CUE** key, pressing this key sets its Hot Cue point at the current playback position (see “Setting Hot Cue points” on page 16).
If a Hot Cue point has been set and the Flash Start is on, pressing the associated **HOT CUE** key will restart playback from that point. When the Flash Start is off, the unit pauses at the Hot Cue point (see “Hot Cue” on page 16).

NOTE

Pressing the **HOT CUE** key while holding down the **SHIFT** key will clear the Hot Cue point currently set.

- ⑩ **JOG dial** When **SRCH** is selected using the **SRCHKEY** setting in the Setup menu (see “Setup menu” on page 13), turning this dial causes pitch bend that temporarily changes the playback tempo. Playback will return to the original tempo when the **JOG** dial is no longer turned (see “Pitch bend function” on page 19).

When **BEND** is selected using **SRCHKEY** setting in the Setup menu (see “Setup menu” on page 13), turning this dial searches the tracks during playback.

When playback is paused, use this dial for scrub playback.

Use this dial to select menu items and values in the Setup menu.

- ⑪ **RE-LOOP/EXIT key** This key turns loop playback on and off (see “Loop playback” on page 17).
If the **RE-LOOP/EXIT** key is pressed while the **SHIFT** key is held down, any set loop playback starting (IN) and stopping (OUT) points will be cleared.
- ⑫ **IN and OUT keys** These keys are used to set the loop playback starting (IN) point and stopping (OUT) point. Pressing the **OUT** key during loop playback changes the OUT point. In addition, during loop playback, pressing the **OUT** key while holding down the **SHIFT** key allows the **JOG** dial to be used to change the OUT point (see “Loop playback” on page 17 and “Re-loop playback” on page 18).
- ⑬ **Tempo slider** The slider adjusts playback tempo. Pushing it in the “-” direction slows the tempo while pulling it in the “+” direction accelerates it. The amount of adjustment possible depends on the Tempo Range setting.

NOTE

During TT-M1 use, the tempo slider cannot be used.

- ⑭ **TEMPO/KEY ORIG key** This key sets the tempo range. Pressing this key will cycle through the following tempo ranges: $\pm 8\%$ (default setting) $\rightarrow \pm 16\% \rightarrow \pm 32\% \rightarrow \pm 100\%$.
The value flashes for a few seconds, and it will light up when entered.

Pressing this key while the **SHIFT** key is held down switches the Key Original on or off.

NOTE

During the TT-M1 use, this key cannot be used.

2- Features of the CD-DJ1

Front panel

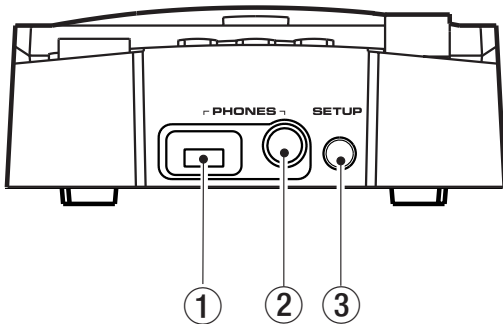

- ① **PHONES volume dial** This dial adjusts the headphone output volume.
- ② **PHONES OUT jack** This is a 1/4" (6.3 mm) stereo headphone jack.
- ③ **SETUP key** Enter Setup menu mode by pressing this key (see "Setup menu" on page 13).

Rear panel

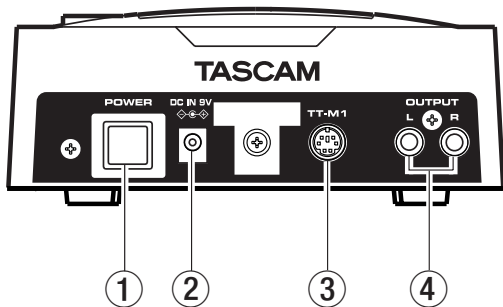

- ① **Power switch** This turns the CD-DJ1 power on and off.
- ② **DC IN 9V jack** Connect the supplied AC adapter here.
- ③ **TT-M1 jack** Connects a separately sold TASCAM TT-M1 scratch controller (see "TT-M1 use" on page 22).
- ④ **OUTPUT L/R jack (RCA pin jacks)** These jacks output the playback sound, and have a nominal output level of -10 dBV.

Display features

The display shows the status of the CD-DJ1 and information about the loaded disc. Normally, the display shows the current settings and conditions, but when the **SETUP** key is pressed, the Setup menu is shown.

The backlight brightness and display contrast can be adjusted using the Setup menu (see "Adjusting the backlight" and "Adjusting the contrast" on page 23).

The "home" screen

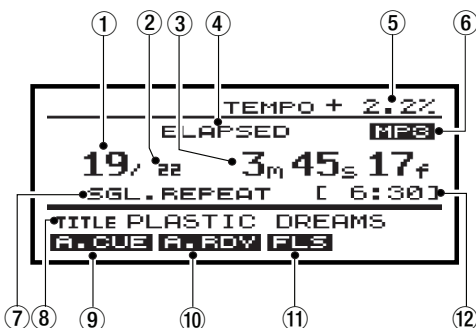

- ① **Track number** This shows the number of the currently selected track.
- ② **Total number of tracks** During audio CD playback, the total number of tracks on the disc will be shown.
During MP3 playback, depending on the Setup menu **FOLDER** setting, the number of tracks in the current folder or the total number of tracks on the disc will be shown.

2- Features of the CD-DJ1

- ③ **Playback time** The time value shown depends on the currently selected playback time display mode. **NO DISC** will be displayed when there is no disc in the unit.
- ④ **Playback time display mode** The selected playback time display mode (**ELAPSED**, **REMAIN**, or **TOTAL REMAIN**) is shown.
- ⑤ **Tempo display** The **TEMPO** indicator and the current tempo value are displayed.
When the Key Original function is on, **K.ORIG** appears in place of the **TEMPO** indicator.
When the TT-M1 switch is turned on, the **TT-M** indicator is shown instead of the tempo value.
- ⑥ **MP3** **MP3** will be displayed during MP3 playback.
- ⑦ **Playback/repeat mode** Displays the current playback and repeat mode.
 - Continuous playback of all tracks: (no indication)
 - Single-track playback: **SINGLE**
 - All track repeat playback: **ALL REPEAT**
 - Single-track repeat playback: **SGL.REPEAT**
- ⑧ **Track title or playback position** Displays CD text data, MP3 file titles and other information about the currently playing track. Nothing will be displayed for audio CDs without text data.

Playback position During audio CD playback, the current track playback position will be shown with a 24-segment position indicator.

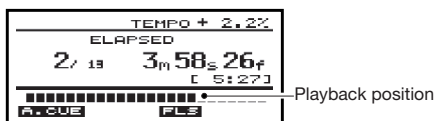

When the playback time display mode is set to **ELAPSED**, the position indicator fills up from the left.

When the playback time display mode is set to **REMAIN** or **TOTAL REMAIN**, the position indicator becomes shorter, with the segments disappearing from the left.

When the remaining playback time for the current track is less than 30 seconds, the position indicator will flash slowly. When the remaining playback time is less than 10 seconds, the indicator will flash rapidly.

The position indicator is not be shown during MP3 playback or when no disc is loaded.

- ⑨ **Auto Cue** **A.CUE** indicator appears when the Auto Cue function is on.
- ⑩ **Auto Ready** **A.RDY** indicator appears when the Auto Ready function is on.
- ⑪ **Flash Start** **FLS** indicator appears when the Flash Start function is on.
- ⑫ **Current track length** The length of the currently playing track is displayed as **00:00** (minutes and seconds) during audio CD playback.

Setup screen

The setup screen is shown on the display during Setup menu mode. For further details, please see “Setup menu” on page 13.

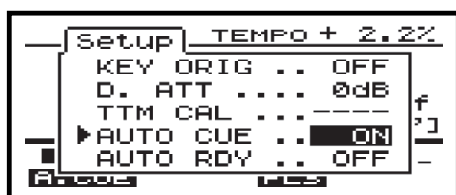

3- Setup menu

Setup menu operation

Various settings can be made using the CD-DJ1 Setup menu. These settings remain even when the power is turned off.

1. Push the SETUP key on the front panel. The Setup menu screen appears. The cursor points to the currently selected menu item.



2. Select a menu item using the JOG dial and push the ENTER key. The current value will be highlighted in reverse contrast.

3. Change the value using the JOG dial.
4. Press the ENTER key to set the value. The highlighting will disappear, and other items in the Setup menu can be selected with the JOG dial.
5. Repeat steps 2 through 4 to set other menu items.
6. When setting menu items is complete, press the SETUP key to exit the Setup menu.

Menu configuration

The Setup menu allows adjustment of the following parameters.

Menu item	Displayed	Function	Manual section
Key Original	KEY ORIG	Turns Key Original function on and off	Key Original function (page 19)
Digital Attenuation	D. ATT	Sets output volume	Setting output volume (page 23)
TT-M1 Calibration	TTM CAL	Calibrates TT-M1	TT-M1 Calibration (page 22)
Auto Cue	AUTO CUE	Turns Auto Cue on and off	Auto Cue (page 15)
Auto Ready	AUTO RDY	Turns Auto Ready on and off	Auto Ready (page 15)
CD-ROM Folder play	FOLDER	Selects disc playback range	Playback range selection (page 20)
Flash Start	FLASH	Turns Flash Start on and off	Flash Start (page 17)
Auto Play	AUTOPLAY	Turns automatic playback at startup on and off	Auto Play (page 23)
CUE Key mode	CUE KEY	Selects CUE key operation mode	Cue (page 16)
Loop OUT Key mode	OUT KEY	Selects OUT key operation mode	Loop playback (page 17)
SEARCH Key function	SRCH KEY	Selects SEARCH key function	Track search (page 15)
LCD Contrast	LCD CONT	Adjusts LCD contrast	Adjusting the contrast (page 23)
Backlight Dimmer	DIMMER	Adjusts display backlight brightness	Adjusting the backlight (page 23)
System Reset	RESET	Resets CD-DJ1 settings and data to original factory values	Resetting the unit (page 22)

4- Playback operations

This chapter explains basic CD player functions. Unless specifically noted, these instructions are for using audio CDs.

For playback of CDs with MP3 files, see “MP3 playback” on page 20.

Discs for playback

The CD-DJ1 can play these types of discs.

- Commercial audio CDs and CD-DA format CD-Rs and CD-RWs.
- CD-Rs and CD-RWs discs with MP3 files recorded in CD-ROM format (see “MP3 playback” on page 20).

However, the CD-DJ1 may not be able to play some CD-Rs and CD-RWs due to disc quality or recording conditions. If the **DISC ERR** error message appears, remove and clean or replace the loaded disc.

Playback modes

This unit has four playback modes. The display shows the currently selected mode. Press the **PLAY MODE** key to change the playback mode.

- Continuous playback of all tracks: (no indication)

- Single-track playback: **SINGLE**
- All track repeat playback: **ALL REPEAT**
- Single-track repeat playback: **SGL.REPEAT**

Basic operation

The following procedures explain use with the factory settings (playback mode is set to continuous playback of all tracks and Auto Cue is on).

WARNING

When using headphones, be careful not to turn up the volume too much. Listening at a high volume over a long time can damage hearing.

1. Turn the power on by pushing the power switch. **NO DISC** appears on the display.
2. Open the CD cover and place a disc label-side up.
3. Close the CD cover. The total number of tracks and the total playback time appears on the display.
4. To prevent accidental CD cover opening, pull down the lock lever until the word **LOCK** appears.

5. Press the **PLAY/PAUSE** key. Playback begins from track 1.

To Pause playback, press the **PLAY/PAUSE** key. Press the **PLAY/PAUSE** key again to restart playback.

Use the **SKIP** keys to select specific tracks for playback.

To monitor the sound with headphones, plug the headphone cord into the **PHONES OUT** jack and adjust the level with the **PHONES** volume dial.

NOTE

The CD-DJ1 does not have a STOP key.

Track selection

Use the **SKIP** (**◀◀/▶▶**) keys to select tracks.

Press the **◀◀ SKIP** key once when the CD is playing or paused to jump to the start of the currently selected track. Press the **◀◀ SKIP** key again to jump to the start of the previous track.

Pressing a **SKIP** key during playback starts playing the newly selected track immediately.

Pressing a **SKIP** key when the CD is paused sets the pause position to the start of the selected track (if Auto Cue is on, the pause position is set to the first moment of sound on the selected track).

4- Playback operations

When used with MP3 file discs, depending on the Setup menu FOLDER setting, the **SKIP** (◀◀/▶▶) keys cycle through either all the tracks on the disc or only the tracks in the currently selected folder. Regardless of

the FOLDER setting, however, pressing a **SKIP** (◀◀/▶▶) key while holding down the **SHIFT** key skips between folders.

Track search

Depending on the Setup menu SRCH KEY setting, use either the **JOG** dial or the **SEARCH** (◀◀/▶▶) keys to search tracks.

When the SRCH KEY setting is **SRCH**, hold down a **SEARCH** (◀◀ or ▶▶) key while the CD is playing or paused to search through the track. The ▶▶ key searches forward and the ◀◀ key searches backward.

When the SRCH KEY setting is **BEND**, turn the **JOG** dial during playback to search the track. Turn clockwise to search forward and counterclockwise to search backward.

Turning the **JOG** dial while the CD is paused allows scrub playback.

Auto Cue

If the Auto Cue function is on when a track is selected, the pause position will be set at the first moment of sound rather than the start of the track. This allows the music on the selected track to be heard immediately when the **PLAY/PAUSE** key is pressed if there is silence at the start of the track.

Turn this function on and off using the Setup menu **AUTO CUE** item.

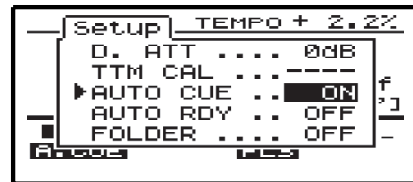

The **A.CUE** indicator appears on the display when the Auto Cue function is on.

Auto Ready

When the Auto Ready function is on, after a track finishes playing, playback will pause at the start of the next track.

NOTE

If the Auto Cue function is also on, playback will pause at the first moment of sound rather than the start of the next track.

Turn this function on and off using the Setup menu **AUTO RDY** item.

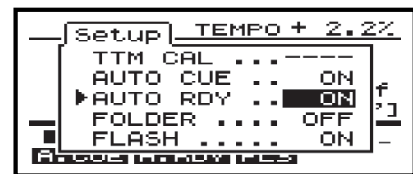

The **A.RDY** indicator appears on the display when the Auto Ready function is on.

CD text data display

Press the **TIME/ENTER/TITLE** key while holding down the **SHIFT** key to change the information displayed when using discs with CD text data.

Track title (**TITLE**)

Artist name (**NAME**)

CD text data will automatically disappear from the display after about twenty seconds.

5- DJ functions

The unit's DJ functions include Cue, Hot Cue (Flash Start), Loop playback, Tempo control, and Pitch bend.

Cue

A cue point can be set that allows you to pause playback and jump to that point by pressing the **CUE** key.

Setting the cue point

The two modes for setting cue point are as follows.

- **Play mode (default setting):**

The cue point is automatically set as the last playback start point.

- **Cue mode:**

The cue point is set as the point where the unlit **CUE** key is pressed when the CD is paused or during scrub playback.

Press the **CUE** key while holding down the **SHIFT** key to display the current mode (**PLAY** or **CUE**) briefly. Change the mode by pressing the **CUE** key again while the mode is displayed.

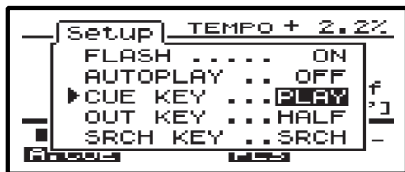

The setting can also be changed by selecting **PLAY** or **CUE** in the Setup menu CUE KEY item.

NOTE

The CUE key lights when a cue point is set. When the mode setting is CUE, the key will flash during pause or scrub playback.

The cue point is canceled when the CD cover is opened.

Using and confirming the cue point

By pressing the **CUE** key once, you can pause playback and jump to the cue point. If you press and hold down the **CUE** key again, playback continues from the cue point until you release the key.

When you release the **CUE** key, playback pauses and the playback position resets to the same cue point.

The cue point can be confirmed using this function.

To resume normal playback, press the **PLAY/PAUSE** key during playback while holding down the **CUE** key.

Hot Cue

The CD-DJ1 has two **HOT CUE** keys (1 and 2) that allow you to set independent Hot Cue points. After a Hot Cue point has been set, pressing its **HOT CUE** key either starts or pauses playback at that point.

Use the Setup menu FLASH Start item to set whether **HOT CUE** keys start or pause playback (see “Flash Start” on page 17).

Setting Hot Cue points

Press an unlit **HOT CUE** key during playback, pause, or scrub playback. The Hot Cue point for that key will be set and the key will light up.

Canceling Hot Cue points

Cancel a Hot Cue point by pressing its **HOT CUE/CLEAR** key while holding down the **SHIFT** key.

Opening the CD cover also cancels the Hot Cue points.

Using and confirming Hot Cue points

When Flash Start is off, you can jump to a Hot Cue point and pause playback by pressing a **HOT CUE** key. If you press and hold down that **HOT CUE** key again, playback continues from that Hot Cue point until you release the key.

When you release the **HOT CUE** key, playback pauses

and the playback position is reset at the Hot Cue point. Hot Cue points can be confirmed using this function.

To resume normal playback, press the **PLAY/PAUSE** key during playback while holding down a **HOT CUE** key.

Flash Start

Use the **HOT CUE** keys for instant playback from their cue points when the Flash Start function is on.

Turn the Flash Start function on and off with the Setup menu **FLASH** item (the default setting is on).

When Flash Start is on, the **FLS** indicator appears on the display.

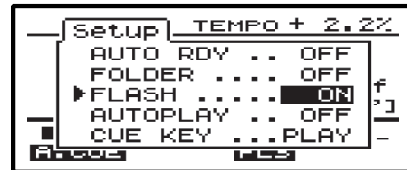

Loop playback

Use this function to loop playback of any section of an audio CD between set **IN** and **OUT** points.

The following procedure explains how to set and play a loop section with starting (**IN**) and ending (**OUT**) points.

Setting the IN point

Press the **IN** key while the CD is playing or paused. The **IN** key will light up and the **OUT** key will flash.

Setting the OUT point

Press the **OUT** key while the CD is playing or paused. The **IN**, **OUT** and **RE-LOOP/EXIT** keys will all light up.

Loop playback will start immediately if the **OUT** point is set while the CD is playing.

Setting the **OUT** point while the CD is paused moves the pause position to the **IN** point. Push the **PLAY/PAUSE** key to begin loop playback.

During loop playback, as soon as the **OUT** point is reached, playback restarts instantly from the **IN** point.

NOTE

*The **OUT** point can only be set at a time following the **IN** point.*

*The **OUT** point can be set to create a loop that spans more than one track.*

Canceling loop playback

Press the **RE-LOOP/EXIT** key during loop playback to exit the loop mode and resume normal playback. The key's light will turn off, but the loop **IN** and **OUT** points will not be cancelled.

Using a **SKIP**, **CUE** or **HOT CUE** key to set the current location outside the looped section will also exit loop playback mode. The **RE-LOOP/EXIT** key light will turn off, but the loop points will not be canceled.

5- DJ functions

Re-loop playback

Press the **RE-LOOP/EXIT** key to restart loop playback immediately when it is off but the **IN** and **OUT** points are still set.

Press the **IN** key for immediate playback from the **IN** point when it is set (like a **HOT CUE** key).

Canceling loop points

Cancel the loop (**IN** and **OUT**) points with either of the following actions.

Press the **RE-LOOP/EXIT** key while holding down the **SHIFT** key. Alternatively, open the CD cover.

The **IN** and **OUT** key lights will turn off when the loop points are canceled.

Changing the OUT point

Press the **OUT** key during loop playback to change the **OUT** point and restart loop playback from the **IN** point. The new **OUT** point is determined according to the Setup menu **OUT KEY** setting.

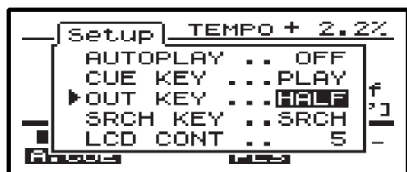

■ HALF

The new **OUT** point is set to a point halfway between the **IN** point and the **OUT** point.

■ SET

The **OUT** point is set at the location where the **OUT** key is pressed during playback.

Adjusting the OUT point

Press the **OUT** key while holding down the **SHIFT** key to enable use of the **JOG** dial for editing the **OUT** point during loop playback. Turn the dial clockwise to lengthen the loop (or counterclockwise to shorten it) during playback until the desired **OUT** point is

reached. Press the **OUT** key at the desired moment to set the new **OUT** point and exit **OUT** point adjustment mode.

The adjustment will affect the loop playback in real time.

Restoring the OUT point

Press the **IN** key while holding down the **SHIFT** key during or after adjustment of the **OUT** point to

restore the **OUT** point to its pre-adjustment position (the display shows **OUT RET**).

Tempo control

Use the tempo slider to control playback speed. The display shows the current tempo adjustment.

Push the slider in the “-” direction to slow the tempo, and pull it in the “+” direction to speed it up.

Setting the tempo range

Use the **TEMPO** key to change the tempo slider range. Press the **TEMPO** key to cycle through the following tempo ranges.

±8% (default setting), ±16%, ±32%, ±100%

The new range setting becomes effective after it flashes on the display for a few seconds.

NOTE

When an attached TT-M1 is turned on, the tempo slider and TEMPO key do not function. Playback tempo value is set by the TT-M1 (see "TT-M1 use" on page 22).

Key Original function

The Key Original function allows you to change the tempo without changing the pitch (key).

NOTE

The Key Original function cannot be used when the tempo range is set to $\pm 100\%$. Setting the tempo range to $\pm 100\%$ automatically turns off the Key Original function.

The Key Original function cannot be used when the TT-M1 is on. Turning on the TT-M1 automatically turns off the Key Original function.

Turn the Key Original function on and off by pressing the **TEMPO/KEY ORIG** key while holding down the **SHIFT** key.

The Key Original function can also be turned on and off in the Setup menu under the **KEY ORIG** item.



The **K.ORIG** indicator appears on the display when the Key Original function is on.

Pitch bend function

Pitch bend temporarily speeds up or slows down the playback speed and changes the playback pitch (if the Key Original function is turned off).

Use the Setup menu **SRCH KEY** item to set whether the pair of **SEARCH** keys or the **JOG** dial controls pitch bend.

The Maximum pitch bend is $\pm 16\%$.

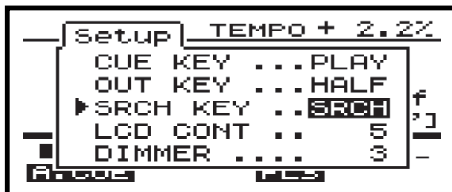

■ When set to SRCH:

The **SEARCH** keys are used for searching. Use the **JOG** dial for pitch bend. Turn it clockwise to speed up and counterclockwise to slow down playback. Stop turning to return to the original speed (as adjusted by the tempo slider).

NOTE

*When set to **SRCH**, the **SEARCH** keys function as normal search keys (see "Track search" on page 15). However, pressing a **SEARCH** key while holding down the **SHIFT** key will cause pitch bend.*

■ When set to BEND:

Use the **SEARCH** keys for pitch bend and the **JOG** dial for searching. Press and hold either key during playback to change the tempo. Release the key to restore the original playback tempo.

NOTE

When the Key Original function is on, bending the pitch will change the tempo, but not the pitch.

6- MP3 playback

This unit can play back MP3 file discs that meet the following requirements.

- Disc: CD-ROM MODE 1 (Multi-session discs are unsupported, but playback of the files in the first recorded session is possible.)
- File format: MPEG 1 Audio Layer 3

- Bit rate: 32 to 192 kbps (VBR is not supported)
- Sampling frequency: 44.1k Hz, mono or stereo
- File extensions: mp3, Mp3, mP3, MP3
- ID3 tags are supported.

Playback range selection

MP3 file playback can be set to either play all tracks in the currently selected folder or all tracks on the disc (in all folders). Use the Setup menu FOLDER item to choose this option.

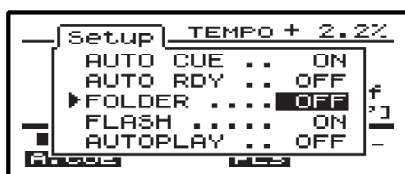

Set the FOLDER menu item to **OFF** (default setting) to select complete disc playback. Set it to **ON** to play only the tracks in the selected folder.

■ Folder selection

Press a **SKIP** key while holding down the **SHIFT** key to select folders.

Display indication

- **MP3** appears on the display during MP3 playback.
- The time display mode is always **ELAPSED** (track time elapsed). **REMAIN** and **TOTAL REMAIN** are not used with MP3 files.
- Press the **TIME/ENTER/TITLE** key while holding the **SHIFT** key to change the MP3 information display.
 - Track titles (**TITLE**)
 - File names (**FILE**)
- The total track number displayed depends on the Setup menu FOLDER setting. The number shown is either the total number of MP3 files in the current folder or the total number on the disc.

Functions disabled during MP3 playback

The following functions cannot be used during MP3 playback.

- Track search
- JOG dial operation (scrub playback)
- Cue
- Hot Cue
- Loop playback

MP3 file folders and tracks

MP3 files recorded onto a CD are handled the same way as files are handled in an ordinary PC, with some MP3 files held within a folder. In addition, several folders can be combined into one folder. This results in multiple layers of folders and files.

NOTE

Each MP3 file is handled as a track.

Folders that do not contain MP3 files directly under them cannot be selected for playback. For example, in the diagram here, under folder A are folder B and folder C. If there are MP3 files in both folders B and C, folder A cannot be selected for playback, but folder B and C can be selected for playback.

The CD-DJ1 can play back MP3 files recorded in formats that conform to ISO9660 level 1, level 2, and the Joliet extensions.

CDs containing MP3s to be played by the CD-DJ1 have their contents must be within the following maximum limits:

Number of folders: 255

Number of hierarchical structures: 8

Number of MP3 files: 999

Title length of MP3 files and folders: 255

MP3 files are played in the following order.

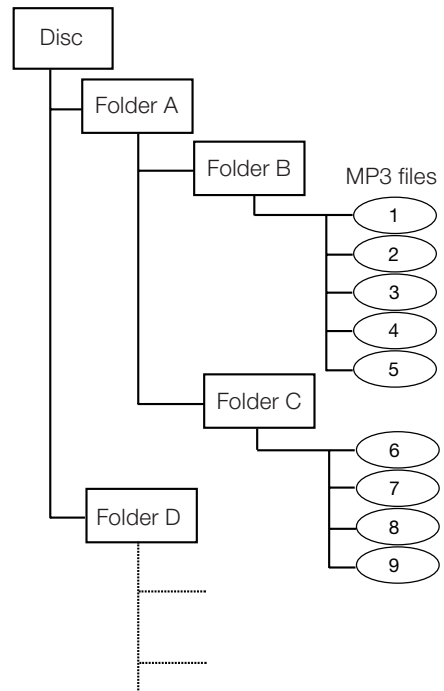

In this manner, playback proceeds from the top level folders.

7- Other features

TT-M1 use

The CD-DJ1 has a TT-M1 jack for connecting a TASCAM TT-M1 (sold separately). An analog turntable with an attached TT-M1 connected to the unit

by this jack can be used to control CD playback speed and direction.

Turning the TT-M1 on and off

Use the switch on the TT-M1 to turn it on and off.

When the TT-M1 switch is turned on, the TT-M1 controls CD playback speed and direction. The LED on the TT-M1 lights when it is on.

When the TT-M1 switch is off, the TT-M1 does not function and its LED is not lit.

TT-M1 Calibration

Calibration is necessary before using the TT-M1.

1. Press the TT-M1 power switch.
2. Run the analog turntable at regular speed (33 rpm at 0% tempo adjustment).
3. Push the PLAY/PAUSE key while holding down the SHIFT key on the CD-DJ1. Alternatively, select the Setup menu TTM CAL item and press the ENTER key.
4. Calibration starts. TTM CAL appears on the display during calibration.
5. If calibration completes correctly, CAL OK appears on the display.

NOTE

Calibration measures the TT-M1 sensing conditions (signal pulse rate and wow amount) during analog turntable playback at 33 rpm to optimize the CD-DJ1 for accurate playback control by the TT-M1.

If the analog turntable rotation is unstable or extremely fast or slow, calibration will not complete correctly and the measurements will be ignored. CAL ERR will appear on the display.

Functions disabled during TT-M1 use

The following functions and operations are disabled during TT-M1 use.

- Tempo adjustment using the tempo slider
- Tempo range change
- Pitch bend using the JOG dial or track SEARCH keys
- Key Original function (automatically turned off)

The TT-M1 is disabled when the CD-DJ1 search functions are used.

Resetting the unit

Use the Setup menu RESET item to restore all the settings and information to the factory-set defaults.

When the menu cursor is aligned with the RESET item, press the ENTER key. SURE? will appear on the display. Press the ENTER key again to reset the unit. Press any other key to cancel.

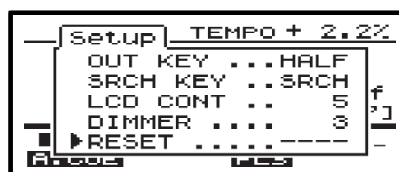

7- Other features

Setting output volume

Use the Setup menu D.ATT item to adjust the output volume from the CD-DJ1 LINE OUT and PHONES OUT jacks.

Adjustment can be made between 0 dB and -20 dB in 1 dB steps. The default value is 0 dB.



Auto Play

Use the Setup menu AUTOPLAY item to turn Auto Play on and off. With this function on, playback will begin as soon as the CD-DJ1 power is turned on. The default setting is off.

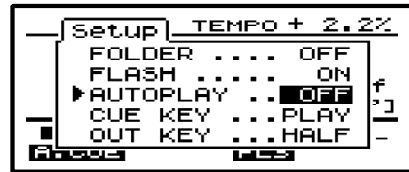

Adjusting the backlight

Set display backlight brightness in the Setup menu. Use the DIMMER item to adjust the brightness between levels 1 and 5.

When the unit enters sleep mode, the backlight turns off.

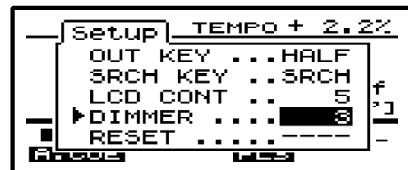

Adjusting the contrast

Use the Setup menu LCD CONT item to adjust the display contrast value between 1 and 10.

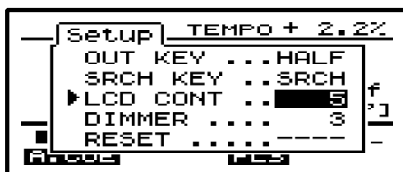

8- Specifications

Specifications

Playable disc size	8 cm (3-inch), 12 cm (5-inch)	
Types	CD, CD-R, CD-RW	
Formats	Audio (CD-DA), Data CDs in ISO9600 Level 1 and 2, Joliet format, containing MP3 files	
Number of channels	2	
Sampling bit rate	16 bits	
Sampling frequency	44.1 kHz	
Line Out	RCA pin jack x 2 Output impedance 600 Ω or less Maximum output level +6 dBV	
Phones Out	1/4" (6.3 mm) stereo phone jack Maximum output 20 mW + 20 mW (into 32 Ω)	
TT-M1 input jack	6-pin mini-DIN	
Power	U.S.A./Canada	120 V AC. 60 Hz
	U.K./Europe	230 V AC. 50 Hz
	Australia	240 V AC. 50 Hz
Power consumption	U.S.A./Canada	6 W
	U.K./Europe/Australia	6 W
Dimensions (W x D x H)	155 x 275 x 60 (mm) / 6.10 x 10.83 x 2.36 (in)	
Weight	1000 g / 35 oz	

Audio performance

Frequency response	20 Hz ~ 20 kHz, +/-0.5 dB	
Dynamic range	> 96 dB	
Signal-to-noise ratio	> 100 dB (with A-FILTER)	
Total harmonic distortion	< 0.005%	
Channel separation	> 98 dB (at 1 kHz, with A-FILTER)	

Note: All measurements are made with tempo change at 0%.

8- Specifications

Backup memory

This unit maintains the following settings even when the power is turned off.

■ Setup menu settings (all except for the system reset parameter)

- Key Original
- Digital Attenuation
- TT-M1 Calibration
- Auto Cue
- Auto Ready
- CD-ROM Folder play
- Flash Start
- Auto Play
- CUE Key mode
- Loop OUT Key mode
- SEARCH Key functions
- LCD Contrast
- Backlight Dimmer

■ Other settings

- Tempo control settings
- Playback and repeat mode
- Playback time display mode

Dimensional drawing

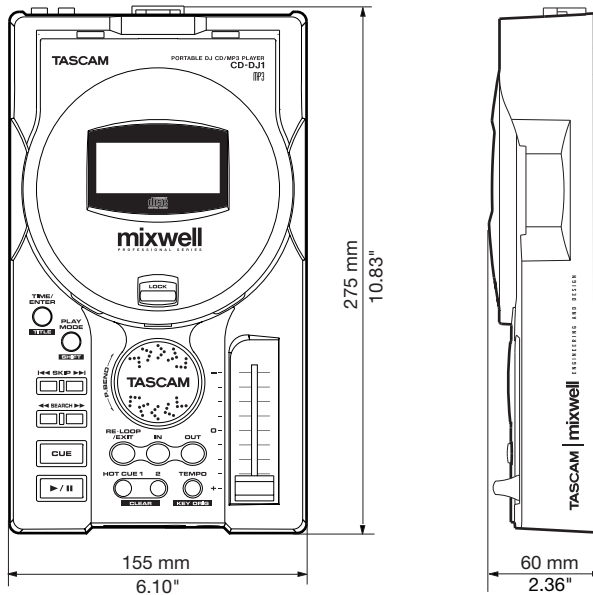

TASCAM

TEAC Professional Division

CD-DJ1

TEAC CORPORATION

Phone: +81-422-52-5082
3-7-3, Nakacho, Musashino-shi, Tokyo 180-8550 Japan

www.tascam.com

TEAC AMERICA, INC.

Phone: +1-323-726-0303
7733 Telegraph Road, Montebello, California 90640 U.S.A.

www.tascam.com

TEAC CANADA LTD.

Phone: +1905-890-8008 Facsimile: +1905-890-9888
5939 Wallace Street, Mississauga, Ontario L4Z 1Z8 Canada

www.tascam.com

TEAC MEXICO, S.A. De C.V

Phone: +52-555-581-5500
Campesinos No. 184, Colonia Granjes Esmeralda, Delegacion Iztapalapa CP 09810 Mexico DF

www.tascam.com

TEAC UK LIMITED

Phone: +44-8451-302511
Unit 19 & 20, The Courtyards Hatters Lane, Watford, Hertfordshire. WD18 8TE U.K.

www.tascam.co.uk

TEAC EUROPE GmbH

Phone: +49-611-71580
Bahnstrasse 12, 65205 Wiesbaden-Erbenheim, Germany

www.tascam.de

Printed in China

Free Manuals Download Website

<http://myh66.com>

<http://usermanuals.us>

<http://www.somanuals.com>

<http://www.4manuals.cc>

<http://www.manual-lib.com>

<http://www.404manual.com>

<http://www.luxmanual.com>

<http://aubethermostatmanual.com>

Golf course search by state

<http://golfingnear.com>

Email search by domain

<http://emailbydomain.com>

Auto manuals search

<http://auto.somanuals.com>

TV manuals search

<http://tv.somanuals.com>