

TASCAM

202MKVI

Double Auto Reverse Cassette Deck

OWNER'S MANUAL

ENGLISH

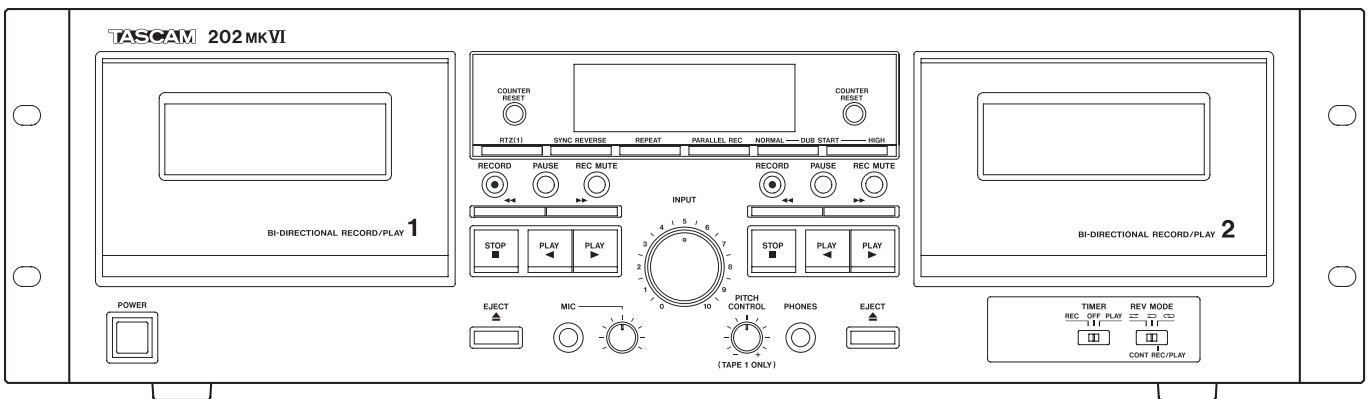

IMPORTANT SAFETY INSTRUCTIONS



CAUTION
RISK OF ELECTRIC SHOCK
DO NOT OPEN



CAUTION: TO REDUCE THE RISK OF ELECTRIC SHOCK, DO NOT REMOVE COVER (OR BACK). NO USER-SERVICEABLE PARTS INSIDE. REFER SERVICING TO QUALIFIED SERVICE PERSONNEL.



The lightning flash with arrowhead in an equilateral triangle is intended to alert the user to the presence of uninsulated "dangerous voltage" within the product's enclosure that could be of sufficient magnitude to constitute a risk of electric shock to persons.



The exclamation point in an equilateral triangle is intended to alert the user to the presence of important operating and maintenance (servicing) instructions in the literature accompanying the appliance.

IN USA/CANADA, USE ONLY ON 120 V SUPPLY.

WARNING: TO PREVENT FIRE OR SHOCK HAZARD, DO NOT EXPOSE THIS APPLIANCE TO RAIN OR MOISTURE.

CAUTION

- DO NOT REMOVE THE EXTERNAL CASES OR CABINETS TO EXPOSE THE ELECTRONICS. NO USER SERVICEABLE PARTS ARE INSIDE.
- IF YOU ARE EXPERIENCING PROBLEMS WITH THIS PRODUCT, CONTACT THE STORE WHERE YOU PURCHASED THE UNIT FOR A SERVICE REFERRAL. DO NOT USE THE PRODUCT UNTIL IT HAS BEEN REPAIRED.
- USE OF CONTROLS OR ADJUSTMENTS OR PERFORMANCE OF PROCEDURES OTHER THAN THOSE SPECIFIED HEREIN MAY RESULT IN HAZARDOUS RADIATION EXPOSURE.

Model for USA

This equipment complies with Part 15 of FCC Rules. Operation is subject to the following two conditions:

- 1) This device may not cause interference and
- 2) This device must accept any interference, including interference that may cause undesired operation of the device.

INFORMATION TO THE USER

This equipment has been tested and found to comply with the limits for a Class A digital device, pursuant to Part 15 of the FCC Rules. These limits are designed to provide reasonable protection against harmful interference when the equipment is operated in a commercial environment. This equipment generates, uses, and can radiate radio frequency energy and, if not installed and used in accordance with the instruction manual, may cause harmful interference to radio communications.

Operation of this equipment in a residential area is likely to cause harmful interference in which case the user will be required to correct the interference at his own expense.

CAUTION

Changes or modifications to this equipment not expressly approved by TEAC CORPORATION for compliance could void the user's authority to operate this equipment.

Model for Canada

THIS CLASS A DIGITAL APPARATUS COMPLIES WITH CANADIAN ICES-003.

CET APPAREIL NUMERIQUE DE LA CLASSE A EST CONFORME A LA NORME NMB-003 DU CANADA.

CE Marking Information

- a) Applicable electromagnetic environment: E4
- b) The average half-cycle r.m.s. inrush current
 1. On initial switch-on: 0.48 Arms
 2. After a supply interruption of 5s: 0.18 Arms

- 1) Read these instructions.
- 2) Keep these instructions.
- 3) Heed all warnings.
- 4) Follow all instructions.
- 5) Do not use this apparatus near water.
- 6) Clean only with dry cloth.
- 7) Do not block any ventilation openings. Install in accordance with the manufacturer's instructions.
- 8) Do not install near any heat sources such as radiators, heat registers, stoves, or other apparatus (including amplifiers) that produce heat.
- 9) Do not defeat the safety purpose of the polarized or grounding-type plug. A polarized plug has two blades with one wider than the other. A grounding type plug has two blades and a third grounding prong. The wide blade or the third prong are provided for your safety. If the provided plug does not fit into your outlet, consult an electrician for replacement of the obsolete outlet.
- 10) Protect the power cord from being walked on or pinched particularly at plugs, convenience receptacles, and the point where they exit from the apparatus.
- 11) Only use attachments/accessories specified by the manufacturer.
- 12) Use only with the cart, stand, tripod, bracket, or table specified by the manufacturer, or sold with the apparatus. When a cart is used, use caution when moving the cart/apparatus combination to avoid injury from tip-over. 
- 13) Unplug this apparatus during lightning storms or when unused for long periods of time.
- 14) Refer all servicing to qualified service personnel. Servicing is required when the apparatus has been damaged in any way, such as power-supply cord or plug is damaged, liquid has been spilled or objects have fallen into the apparatus, the apparatus has been exposed to rain or moisture, does not operate normally, or has been dropped.
 - The apparatus draws nominal non-operating power from the AC outlet with its POWER or STANDBY/ON switch not in the ON position.
 - The mains plug is used as the disconnect device, the disconnect device shall remain readily operable.
 - Caution should be taken when using earphones or headphones with the product because excessive sound pressure (volume) from earphones or headphones can cause hearing loss.

CAUTION

- Do not expose this apparatus to drips or splashes.
- Do not place any objects filled with liquids, such as vases, on the apparatus.
- Do not install this apparatus in a confined space such as a book case or similar unit.
- The apparatus should be located close enough to the AC outlet so that you can easily reach the power cord plug at any time.
- If the product uses batteries (including a battery pack or installed batteries), they should not be exposed to sunshine, fire or excessive heat.
- CAUTION for products that use replaceable lithium batteries: there is danger of explosion if a battery is replaced with an incorrect type of battery. Replace only with the same or equivalent type.

WARNING

Products with Class **I** construction are equipped with a power supply cord that has a grounding plug. The cord of such a product must be plugged into an AC outlet that has a protective grounding connection.

For the customers in Europe

WARNING

This is a Class A product. In a domestic environment, this product may cause radio interference in which case the user may be required to take adequate measures.

Pour les utilisateurs en Europe

AVERTISSEMENT

Il s'agit d'un produit de Classe A. Dans un environnement domestique, cet appareil peut provoquer des interférences radio, dans ce cas l'utilisateur peut être amené à prendre des mesures appropriées.

Für Kunden in Europa

Warnung

Dies ist eine Einrichtung, welche die Funk-Entstörung nach Klasse A besitzt. Diese Einrichtung kann im Wohnbereich Funkstörungen verursachen; in diesem Fall kann vom Betreiber verlangt werden, angemessene Maßnahmen durchzuführen und dafür aufzukommen.

- TASCAM is a trademark of TEAC CORPORATION, registered in the U.S. and other countries.
- Other company names, product names and logos in this document are the trademarks or registered trademarks of their respective owners.

IMPORTANT SAFETY INSTRUCTIONS (continued)

RACK-MOUNTING THE UNIT

Use the supplied rack-mounting kit to mount the unit in a standard 19-inch rack, as shown below.

Remove the feet of the unit before mounting.

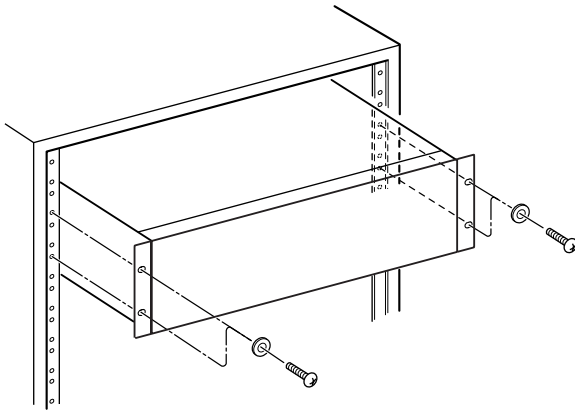

CAUTION

- Leave 1U of space above the unit for ventilation.
- Allow at least 10 cm (4 in) at the rear of the unit for ventilation.

For European Customers

Disposal of electrical and electronic equipment

- (a) All electrical and electronic equipment should be disposed of separately from the municipal waste stream via collection facilities designated by the government or local authorities.
- (b) By disposing of electrical and electronic equipment correctly, you will help save valuable resources and prevent any potential negative effects on human health and the environment.
- (c) Improper disposal of waste electrical and electronic equipment can have serious effects on the environment and human health because of the presence of hazardous substances in the equipment.
- (d) The Waste Electrical and Electronic Equipment (WEEE) symbol, which shows a wheeled bin that has been crossed out, indicates that electrical and electronic equipment must be collected and disposed of separately from household waste. 
- (e) Return and collection systems are available to end users. For more detailed information about the disposal of old electrical and electronic equipment, please contact your city office, waste disposal service or the shop where you purchased the equipment.

DECLARATION OF CONFORMITY

We, TEAC EUROPE GmbH, Bahnstrasse 12, 65205 Wiesbaden-Erbenheim, Germany declare in own responsibility, the TEAC product described in this manual is in compliance with the corresponding technical standards. 

Contents

Thank you for choosing TEAC. Read this manual carefully to get the best performance from this unit.

IMPORTANT SAFETY INSTRUCTIONS	2
Introduction	6
Supplied accessories	6
About this manual	6
Product registration	6
Precautions and notes for placement and use	6
About cassette tapes	6
Cassette tapes that you should not use	6
Using the TEAC Global Site	6
Automatic tape type detection function	7
Tape slack	7
Accidental erasure prevention tabs	7
Maintenance	7
Features of the 202MKVI	8
Connections	8
Display	9
Front panel	10
Playback	12
Playback 1 (either TAPE 1 or TAPE 2)	12
Playback 2 (either TAPE 1 or TAPE 2)	13
Continuous playback	14
RTZ (TAPE 1 only)	14
A-B Repeat playback	14
Recording	15
Recording (either TAPE 1 or TAPE 2)	15
To erase recordings	16
Quick record start	16
Recording silence	16
Mic mixing recording	17
Adjusting mix recording level	17
Continuous recording	18
Parallel recording	19
Dubbing (from TAPE 1 to TAPE 2)	19
Editing during dubbing (only at normal speed)	20
Synchro reverse dubbing (from TAPE 1 to TAPE 2)	21
Timer-Controlled Playback and Recording	22
Timer-Controlled Playback	22
Timer-controlled recording	22
Connections with a timer	23
Troubleshooting	24
Specifications	25
Dimensions	25

Introduction

Before connecting and using the unit, please take time to read this manual thoroughly to ensure you understand how to properly set up and connect the 202MKVI, as well as the operation of its many useful and convenient functions. After you have finished reading this manual, please keep it in a safe place for future reference

Supplied accessories

In addition to this manual, the 202MKVI has been packed with the following:

Main unit	× 1
A rack-mounting screw kit	× 1
Owner's manual (this document)	× 1

The Warranty is included at the end of this manual.
Contact your TASCAM supplier if any of these items are missing.

About this manual

In this manual, we use the following conventions:

- The names of keys and controls are given in the following typeface: **EJECT**.
- When the alphanumeric portion of the display shows a message, this is shown in the following typeface: **CP01**.
- If a preset indicator in the display (i.e. one which cannot change, but is either on or off) is shown, this is shown as follows: **PARALLEL**.

Product registration

Customers in the USA, please visit the TASCAM website (<http://tascam.com/>) to register as a user online.

Precautions and notes for placement and use

The 202MKVI may be used in most areas, but to maintain top performance, and prolong operating life, observe the following notes, precautions and environmental conditions:

- Avoid exposing it to extremes of temperature and humidity and avoid mechanical shocks and vibration.
- Keep the unit away from strong magnetic fields (TV sets, computer monitors, large electric motors, etc.).
- The nominal temperature should be between 5°C and 35°C (41°F and 95°F).
- Relative humidity should be 30 to 90 percent.
- As the unit may become hot during operation, always leave sufficient space above the unit for ventilation. Do not install this unit in a confined space such as a bookcase, and do not put anything on top of the unit.
- Avoid installing this unit on top of any heat-generating electrical device such as a power amplifier.
- Make sure that the unit is mounted in a level position for correct operation.
- Do not open the sealed cabinet as this might result in damage to the circuitry or electrical shocks. If a foreign object should get inside the unit, contact your supplier.

- When removing the power plug from the wall outlet, always pull directory on the plug, never yank the cord.
- The voltage selector on the rear panel is only available on units for the North American market. Please set this to match your local supply. If you are in any doubt in this matter, consult an electrician.

NOTE

When transporting the unit, always use the original packing materials. For this reason, we strongly recommend that you save all the packing materials that came with the 202MKVI, in case you need to transport it in the future. In addition, when transporting the unit, you should tape the cassette decks closed, using an adhesive tape that will not spoil the finish of the unit.

About cassette tapes

CAUTION

- Do not open the cassette or pull the tape out of the cassette.
- Do not touch the tape surface.
- Do not use or store the tape in a humid or dusty place.
- Keep the tape away from any magnetic sources, such as speakers or TVs, otherwise noise may be produced during playback or important recordings may be erased.

Cassette tapes that you should not use

Poor performance, errors, or malfunctions may result if you use any of the tapes described below. Some of these tapes may also cause tape clog problems that can damage the tape transport mechanism.

Cassettes that are imperfectly shaped

Do not use a deformed cassette or one that has unstable tape movement or makes a strange sound during fast-forward or rewind.

Long play tapes

Tapes that are longer than 90 minutes are very thin and stretch easily, so using them can result in wow and flutter. In addition, long tapes can become tangled in the equipment, so please use caution with them.

Endless tapes

Do not use these tapes because they can easily get tangled in the tape transport mechanism.

Using the TEAC Global Site

You can download the dedicated drivers and Owner's Manual necessary for this unit from the TEAC Global Site (<http://teac-global.com/>).

1. Open the TEAC Global Site (<http://teac-global.com/>).
2. In the TASCAM Downloads section, click the desired language to open the Downloads website page for that language.

NOTE

If the desired language does not appear, click Other Languages.

3. Click the product name in the "Search by Model Name" section to open the Downloads page for that product.
4. Select and download the dedicated drivers and Owner's Manual that are needed.

Automatic tape type detection function

This cassette deck can detect what type of tape is being used based on the detection holes in the cassette shell. Be sure to use cassettes with detection holes.

With this cassette deck, you can play back normal (Type I), high position (Type II) and metal (Type IV) tapes. For recording, use normal (Type I) or high position (Type II) tapes.

Each deck (TAPE 1 and TAPE 2) is equipped with its own auto tape type detection function, so you can use different types of tape at the same time.

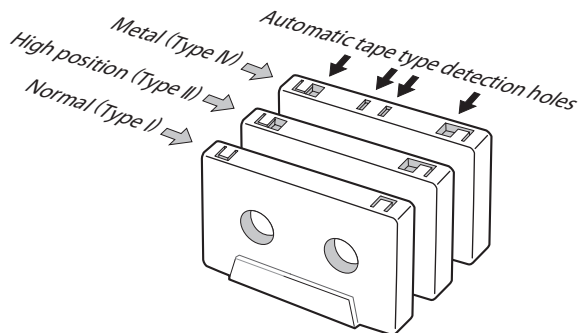

Tape slack

Slack can cause the tape to get tangled in the capstan or other rotating parts. To prevent this, take up all tape slack using a pencil or the like inserted into the reel hole.

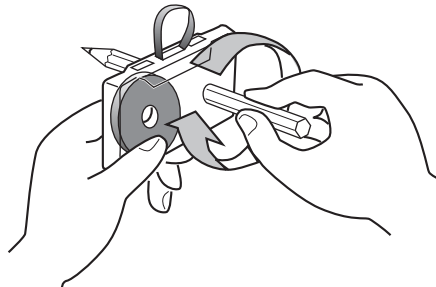

Accidental erasure prevention tabs

Tabs on top of the cassette shell allow you to prevent important recordings from being erased by mistake. There are two tabs on each cassette shell: one for side "A" and the other for side "B".

Once these tabs have been removed using a screwdriver or the like, there is absolutely no chance of the recording function being activated.

To record on a cassette whose tab has been broken off, stick a piece of adhesive tape over the hole. Be careful not to block the tape type detection holes.



Maintenance

If the surface of the deck becomes soiled, wipe it clean with a dry, soft cloth. Never use volatile cleaners like thinners or alcohol because they will damage the surface finish.

Do not allow the deck to remain in contact with rubber or vinyl products for a long period of time, as these could damage the surface finish.

CAUTION

For safety, always unplug the power cord before performing any maintenance.

● Cleaning the heads

If the head section gets dirty, the recording quality will deteriorate, resulting in degraded playback sound or "drops" in sound. Also, if the tape transport path gets dirty, the tape may get entangled in the rotating parts. It is therefore recommended that the heads, pinch rollers and capstans be cleaned regularly at intervals of 10-hour use with a cotton swab moistened with a commercially available, appropriate cleaning liquid.

NOTE

Do not make a recording or play back tape when the tape transport path is wet with cleaning liquid, as this could cause the tape to jam or clog.

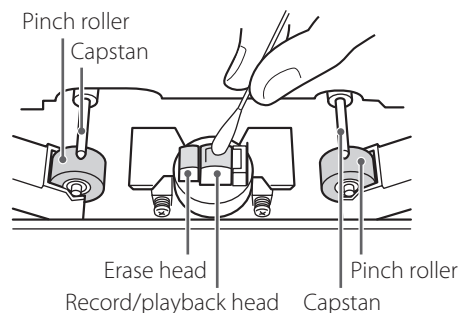

Features of the 202MKVI

Connections

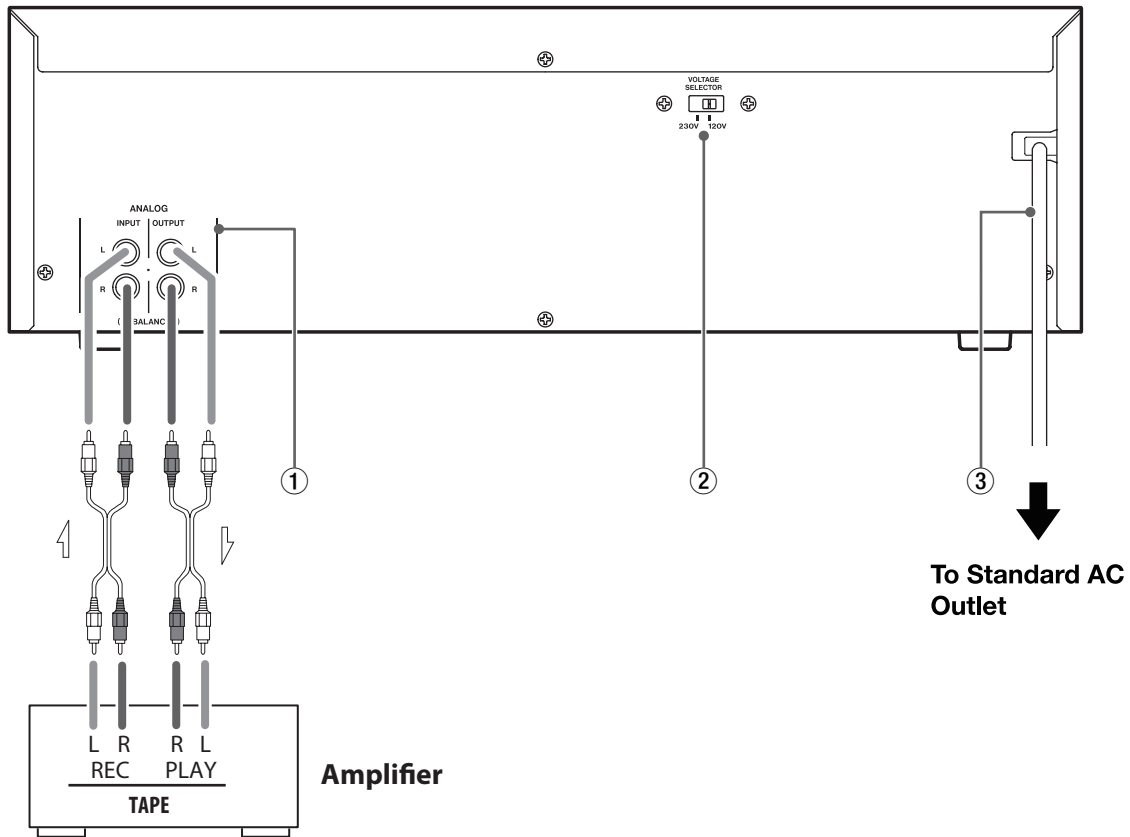

CAUTION

- Plug the power cord into an AC outlet only after having made all other connections.
- Read the instructions of each component you intend to use with this unit.

① ANALOG INPUT and ANALOG OUTPUT jacks

ANALOG INPUT:

Connect these to the LINE OUT jacks of the amplifier or the output jacks of the CD player or other device.

ANALOG OUTPUT:

Connect these to the TAPE/MD/CD-R, AUX or other input jacks of the amplifier.

Refer to the above connection diagram.

NOTE

Plugs must be firmly inserted into the corresponding jacks. Do not bundle the RCA cables together with the power cord and speaker cables. Doing so will degrade sound quality or generate noise.

② VOLTAGE SELECTOR

Switches the voltage to either 230 V or 120 V.

NOTE

- The voltage selector is not available on units for some markets.

IN USA/CANADA
USE ONLY ON 120V SUPPLY

③ AC power cord

Plug this AC power cord into an AC wall socket.

NOTE

- Hold the power plug when plugging or unplugging the power cord. Never pull or yank on the power cord.
- Unplug the power cord when you are not going to use the unit for some time.

Display

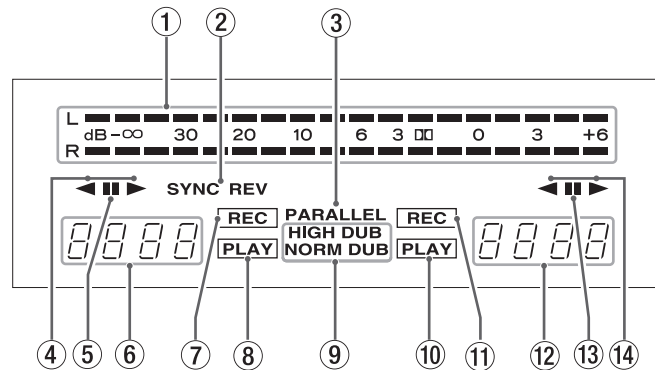

① Peak level meter

This shows recording and playback levels.

② SYNC REV

This indicator lights when the synchro reverse dubbing function is switched on.

③ PARALLEL

This indicator lights to indicate parallel recording is taking place.

④ Playback/recording direction indicator of TAPE 1 deck

⑤ Pause indicator

This indicator lights when the TAPE 1 deck is temporarily stopped.

⑥ Tape counter of TAPE 1 deck

The tape counter indicates the relative position of the tape. You can reset the counter to zero whenever you want. When an A-B repeat operation is on, RE is shown.

⑦ Record indicator

This indicator lights when the TAPE 1 deck is in record mode.

⑧ Play indicator

This indicator lights when the TAPE 1 deck is in play mode.

⑨ Dubbing indicator

NORMAL DUB lights during normal speed dubbing, and **HIGH DUB** lights during high speed dubbing.

⑩ Play indicator

This indicator lights when the TAPE 2 deck is in play mode.

⑪ Record indicator

This indicator lights when the TAPE 2 deck is in record mode.

⑫ Tape counter of TAPE 2 deck

The tape counter indicates the relative position of the tape. You can reset the counter to zero whenever you want. When an A-B repeat operation is on, RE is shown.

⑬ Pause indicator

This indicator lights when the TAPE 2 deck is temporarily stopped.

⑭ Playback/recording direction indicator of TAPE 2 deck

Features of the 202MKVI (continued)

Front panel

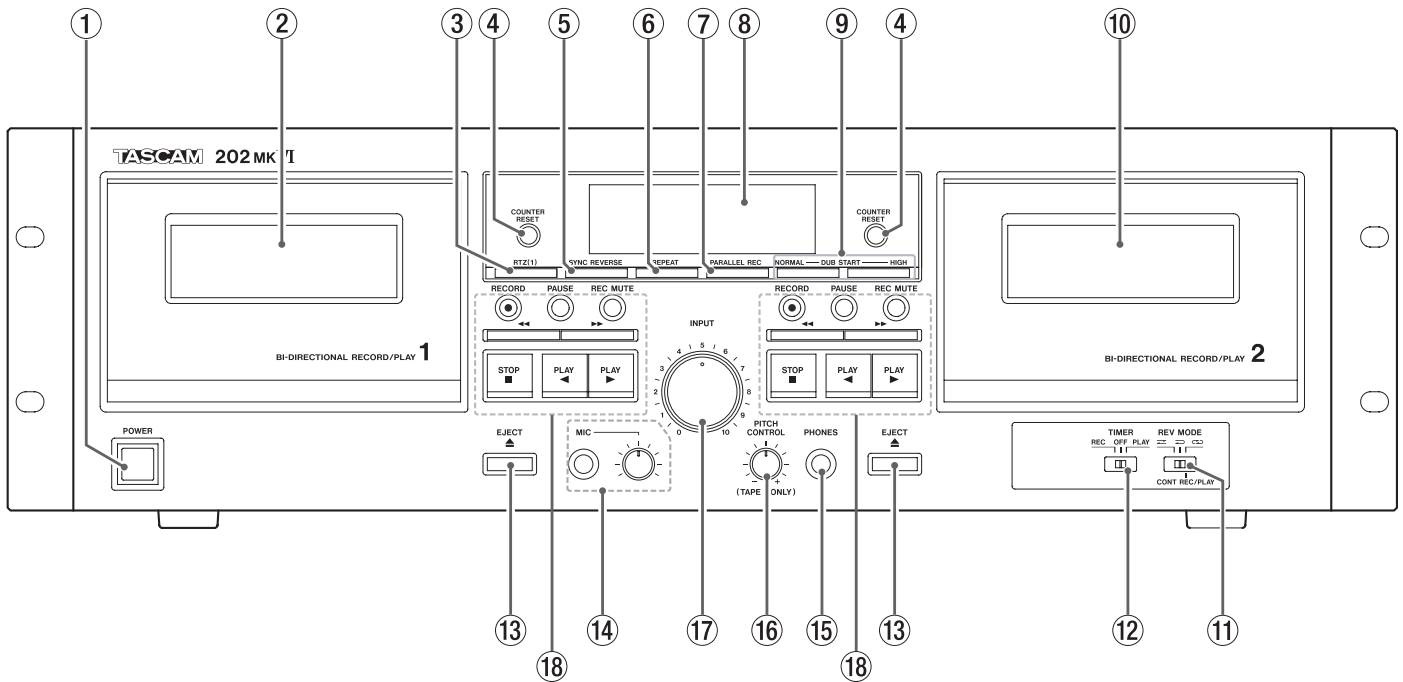

① POWER switch

This switches the unit power between off and on.

② TAPE 1 compartment

③ RTZ(1) key (TAPE 1 only)

This key returns the tape to the counter zero point.

④ COUNTER RESET keys

Pressing these keys reset the tape counter readings for TAPE 1 and TAPE 2, respectively.

⑤ Synchro reverse key (SYNC REVERSE)

Pressing this key activates the synchro reverse dubbing function.

⑥ REPEAT key

This allows repeat playback of a selected section of the tape.

⑦ Parallel record key (PARALLEL REC)

This key lets you simultaneously record on both decks.

⑧ Display

This shows tape counters, level meters, etc.

⑨ Dubbing start key (DUB START)

This key is used when copying the contents of a tape from TAPE 1 to TAPE 2, either at normal or high speed.

⑩ TAPE 2 compartment

⑪ Reverse mode switch (REV MODE)

This switch is used to switch between reverse modes.

⑫ TIMER switch

This switch is provided for use with a commercially available audio timer, to allow timer controlled recording or playback. Normally, leave this switch to the **OFF** position.

⑬ EJECT (▲) keys

Pressing these keys opens the TAPE 1 and TAPE 2 compartments.

⑭ MIC jack and level control

Insert your microphone into this jack and use the knob to adjust the level of mic input.

NOTE

The MIC jack is mono. You cannot use a stereo microphone with this cassette deck.

⑮ Headphones jack (PHONES)

Plug your headphones into this jack.

WARNING

There is no level control for the headphones output. Beware that sudden loud sounds may occur depending on recorded material. You should avoid prolonged exposure to high volume sound as this can damage your hearing.

⑯ PITCH CONTROL

This control is used to vary the playback speed. During dubbing, the pitch control does not work.

⑰ INPUT

This control is used to adjust the recording level.

18 Tape transport control keys

RECORD (●) key

Pressing this key shifts the corresponding deck to record-pause mode.

PAUSE (II) key

Pressing this key temporarily stops playback or recording.

Recording mute (REC MUTE) key

This key is for creating the 4-second blank space.

◀◀/▶▶ key

Fast-forward/Rewind

STOP (■) key

Stop of playback/record.

PLAY (◀ / ▶) key

Reverse side play/Forward side play.

Playback 1 (either TAPE 1 or TAPE 2)

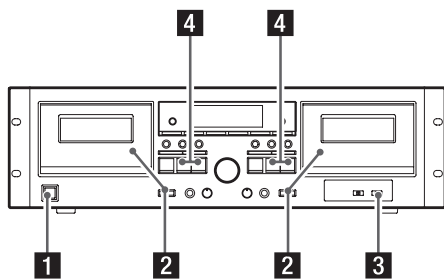

1 Switch on the POWER.

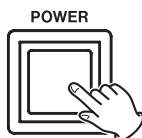

2 Load a pre-recorded tape into the TAPE 1 or 2 deck.

Press the **EJECT** key (\blacktriangle) to open the cassette compartment. Insert the cassette tape with its open edge facing down, the desired side facing you. Then, close the cassette compartment by pushing on its front part.

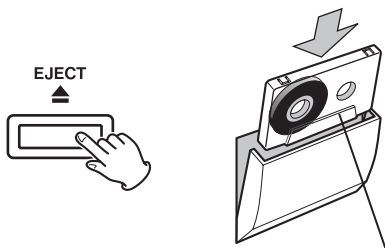

Side "A" facing you

This cassette deck can play back normal (Type I), high position (Type II) and metal (Type IV) tapes.

For the sake of simplicity, we refer to the tape side facing you as Side "A" and to the tape side facing away as Side "B". When you insert a cassette with Sides "A" and "B" reversed, Side "A" should read Side "B" and Side "B" should read Side "A".

3 Select a reverse mode setting using the REV MODE switch.

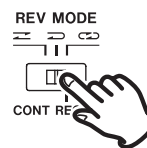

You have a choice of three settings:

\rightleftarrows : One way mode

Set the switch to this position to playback only one side.

\curvearrowright : Two way mode

Set the switch to this position to play back both sides of the tape in one session. When playback reaches the end of side "A", the playback direction is automatically reversed, and playback continues on side "B".

∞ : Repeat mode

Set the switch to this position. Both sides of the tape are played back as many as 5 times.

If a tape is in both the TAPE 1 and TAPE 2 compartments, the TAPE 1 and TAPE 2 decks continuously play the tapes.

4 Press the PLAY (\blacktriangleleft or \blacktriangleright) key.

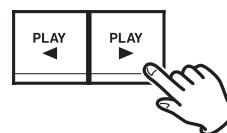

Pressing the \blacktriangleright key starts playback from side "A".
Pressing the \blacktriangleleft key starts playback from side "B".

Playback 2 (either TAPE 1 or TAPE 2)

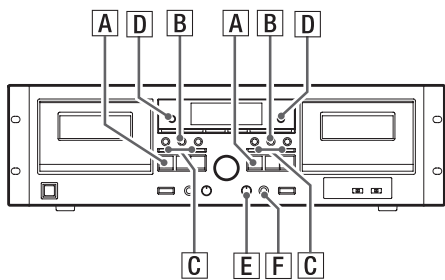

A To stop playback, press the **STOP** (■) key.

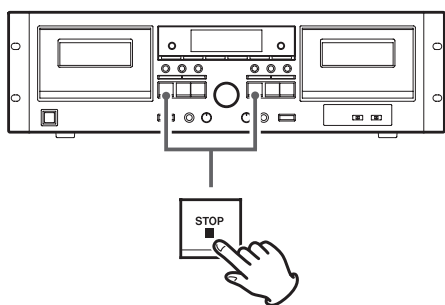

B To stop playback temporarily, press the **PAUSE** key. To resume playback, press the **PAUSE** key again, or press the **PLAY** (◀ or ▶) key.



While playback is paused, pressing the **PLAY** key whose direction is opposite to the indicator (◀ or ▶) on the display, will switch the playback direction. This does not release the pause function. Press **PAUSE** or the same **play** key (◀ or ▶) again to start playback on the other side of the tape.

C **Fast forward/Rewind**

Press the ◀◀ or ▶▶ key while in stop mode to fast wind the tape.

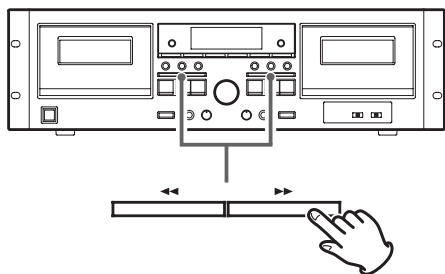

To stop the fast winding tape, press the **STOP** (■) key.

D **Tape counter**

Press the **COUNTER RESET** key to reset the tape counter to 0000. You can use this function for easy relocation of any desired point on the tape.

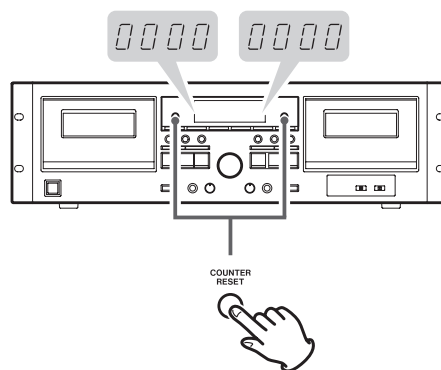

E **Pitch control (TAPE 1 deck only)**

This control varies the pitch of the music during playback (This control does not work during recording or dubbing).

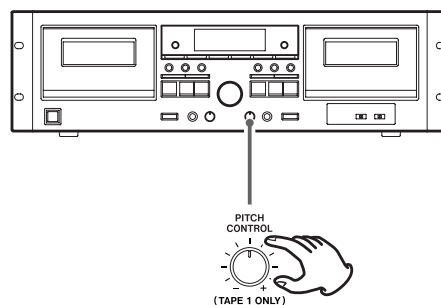

Turning the **PITCH CONTROL** knob clockwise increases the playback speed and raises the pitch up to +10%. Turning the **PITCH CONTROL** knob counterclockwise reduces the playback speed and lowers the pitch by a maximum of -10%.

F **To listen through headphones**

WARNING

There is no level control for the headphones output. Beware that sudden loud sounds may occur depending on recorded material. You should avoid prolonged exposure to high volume sound as this can damage your hearing.

Plug your headphones into the **PHONES** jack, and put on the headphones.

Plugging into the **PHONES** jack does not disable the **ANALOG OUTPUT**.

Continuous playback

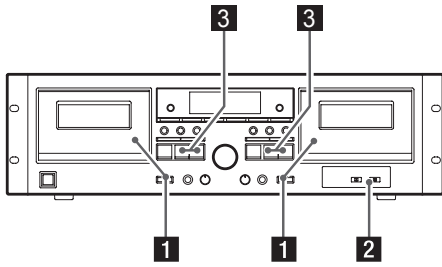

Continuous playback can be performed between TAPE 1 and TAPE 2. When one tape is played back to the end, the other tape automatically starts playback, in a relay fashion.

- 1** Load pre-recorded tapes into the TAPE 1 and TAPE 2 compartments.
- 2** Set the REV MODE switch to the (CONT PLAY) position.

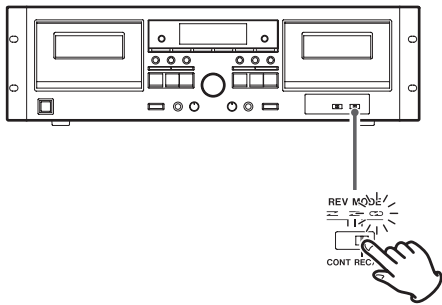

- 3** Press the PLAY (or) key of the deck you want to start first.

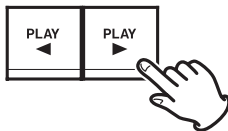

You can start continuous playback from either TAPE 1 or TAPE 2. Playback cycles through four tape sides as follows, and will continue as many as 5 times when you start the playback from Side "A" on TAPE 1, or until you stop the operation.

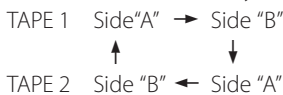

RTZ (TAPE 1 only)

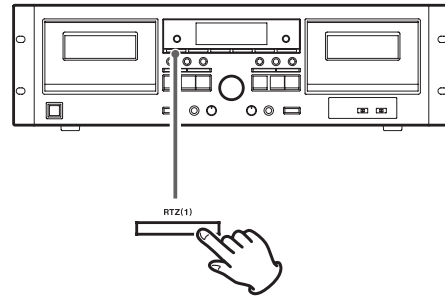

When you press the **RTZ(1)** key, the TAPE 1 deck fast-forwards or rewinds the tape until the counter reads 0000, and then stops.

NOTE

- RTZ (Return-to-zero) only works on TAPE 1.
- If the counter position is too close to the 0000 mark (greater than 9994 or less than 0005), the RTZ function cannot be used.

A-B Repeat playback

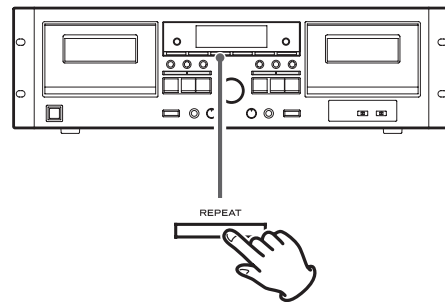

- 1.** During playback, press the REPEAT key at the point where you want to start the repeat playback interval (A point). RE 0 1 appears on the display when this point is set.
- 2.** Next, press the REPEAT key at the point where you want to end the repeat playback interval (B point). RE 0 2 appears on the display. The tape automatically rewinds to the A point where playback restarts. When the B point is reached, playback stops temporarily, the tape rewinds again to the A point, and playback continues to repeat.
- 3.** Press the STOP () key to end repeat playback.

CAUTION

- During repeat playback, only the **REPEAT** and **STOP** keys can be used.
- This function cannot be used for durations of less than 10 counts on the tape counter between the starting and end points.
- Only intervals in the current playback direction can be repeated.
- Repeat playback stops automatically after 20 repetitions.

Recording (either TAPE 1 or TAPE 2)

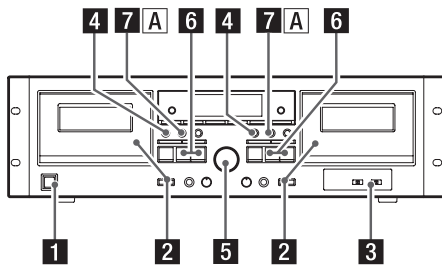

1 Turn on the power.

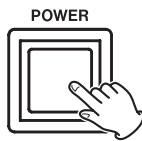

2 Load a tape for recording.

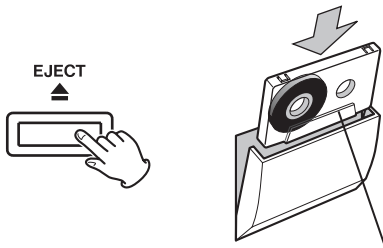

Side "A" facing you

Press the **EJECT** (▲) key to open the cassette compartment. Insert the cassette tape with its open edge facing down, side "A" facing you. Then close the cassette compartment by pushing in the cassette door until it clicks shut.

NOTE

- If the erasure prevention tabs of the loaded cassette tape have been broken off, stick a piece of adhesive tape over the hole(s).
- With this cassette deck you can use normal (Type I) and high position (Type II) tapes for recording.

3 Set the REV MODE switch.

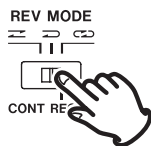

- ⇌ : Set to this position to record on one side only.
- ↔ : Set to this position to record on both sides.

4 Press the RECORD (●) key.



The deck enters the record-pause mode. **||** and **REC** will light on the display.

NOTE

To stop recording while the deck is in the record-pause mode, press the **STOP** key (■).

5 Adjust the recording level.

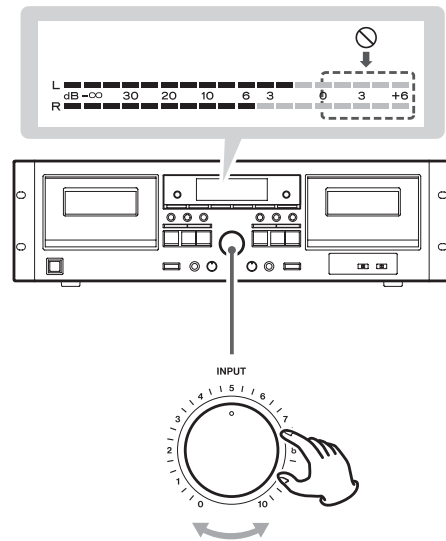

Start playback of your recording source and set the **INPUT** control knob so that the level meter indicates "0 dB" at peaks.

6 Set the recording direction. (To record on only one side of the tape)

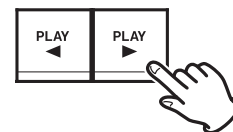





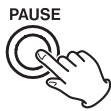

Recording is made in the direction indicated by the play/record direction indicator (◀ / ▶). To change this direction, press the opposite direction **PLAY** (◀ or ▶) key.

NOTE

Make sure that the arrow on the key (◀ / ▶) you are going to press points in the opposite direction of the arrow on the indicator (◀ / ▶) shown on the display. Failure to follow this instruction causes the deck to start recording in an unintended direction.

- 7** When everything is ready, start recording by pressing the **PAUSE** key or the **PLAY** key whose arrow points in the same direction as the indicator.





To record on both tape sides, set the **REV MODE** switch to  or  and press the forward **PLAY** () key. If you press the reverse **PLAY** () key, recording will be done only on side "B". To stop recording, press the **STOP** () key.

- A** To stop recording temporarily





Press the **PAUSE** key to stop recording temporarily. A second press of the key resumes recording.

To erase recordings

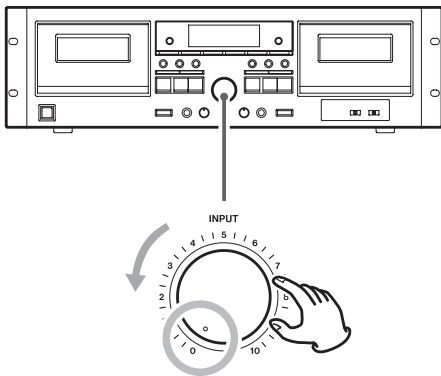
When you make a recording, the tape is overwritten (previous recording is erased). To erase a tape without making a new recording, set the **INPUT** control to the minimum (0) position and press the **RECORD** () key followed by the **PLAY** ( or ) key.



Quick record start

Press the **RECORD** () key and press the **PLAY** ( or ) key corresponding to the direction you want the tape to run.

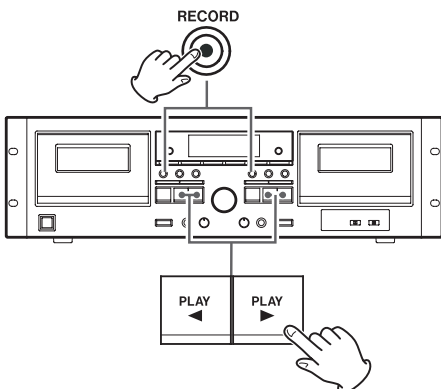

Recording silence

When you press the **REC MUTE** key during recording, the unit records no signal for about 4 seconds and then enters the record-pause mode. To resume recording, press the **PAUSE** key.

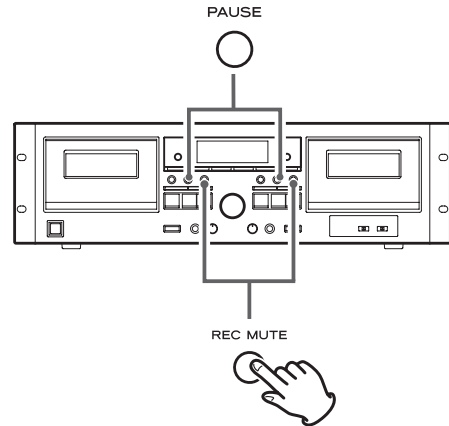

To create a blank of more than 4 seconds long

Hold down the **REC MUTE** key for the desired length of time. When you release the key, the deck enters the record-pause mode.

To create a blank of less than 4 seconds long

Press the **PAUSE** key within 3 seconds of pressing the **REC MUTE** key.

NOTE

If you press the **REC MUTE** key when the deck is in the record-pause mode, no signal is recorded for about 4 seconds, and then the deck shifts back to the record-pause mode.

Mic mixing recording

This function allows you to record your voice and another audio source together on a cassette tape.

The mic sound is fed into both the Left and Right channels so it is located in the center of the stereo image.

You have the choice of either selecting the audio source you want on the amplifier connected to the **ANALOG INPUT** jacks of the deck, or plugging the desired source directly into the deck's **ANALOG INPUT** jacks.

NOTE

- To prevent feedback (howling), disable the speaker outputs from the amplifier. Use headphones to monitor recording.
- This cassette deck is not compatible with stereo mics. Always use a mono mic.

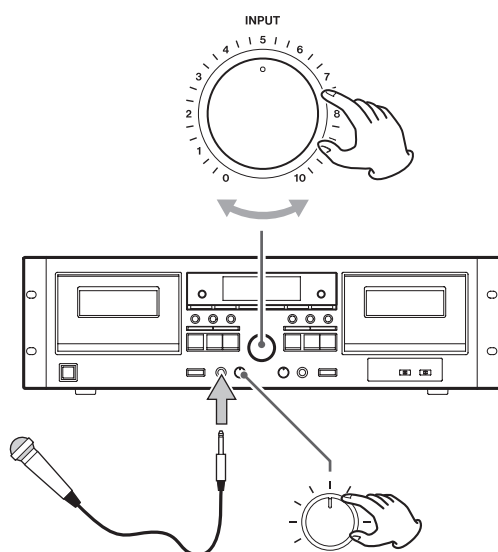

Adjusting mix recording level

To record a mix of voice and another audio source, you need to adjust the mic input level and then fine tune the overall recording level.

1. Plug your microphone into the MIC jack on the front panel.
2. Start playing the audio source, switch the deck into the record-pause mode (by pressing the RECORD (●) key), and temporarily adjust the INPUT control to a relatively low level.
3. Speak into the mic and adjust the MIC level control to get the optimum balance between your voice and the other source.
4. Fine tune the overall recording level using the INPUT control so that the level meter reads 0 dB at peaks.
5. When everything is ready, start recording as instructed earlier in this manual.

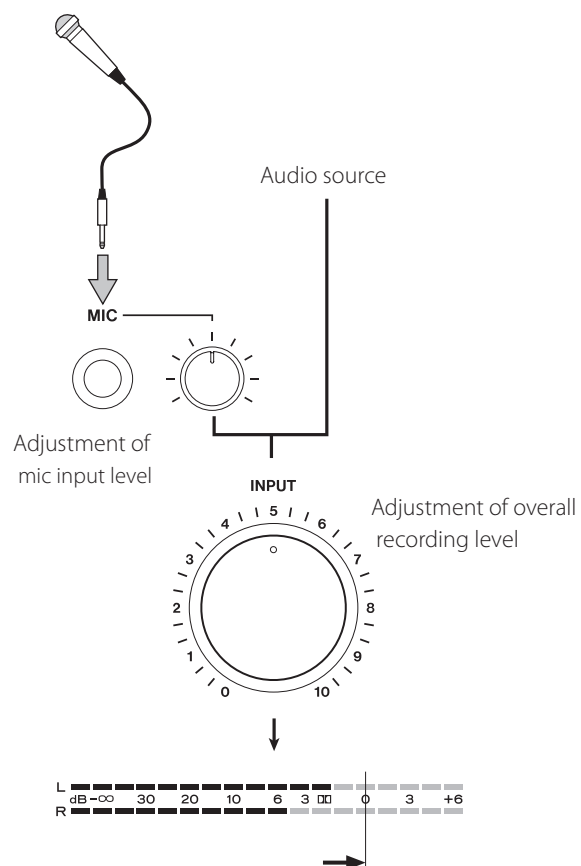

Continuous recording

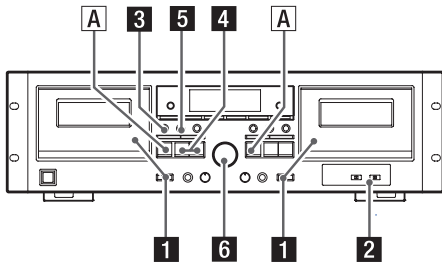

This function allows you to make uninterrupted recordings on both sides of two tapes.

- 1 Load cassette tapes for recording into the TAPE 1 and TAPE 2 compartments.**

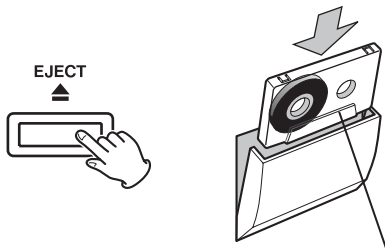

Side "A" facing you

- 2 Set the REV MODE switch to the (CONT REC/PLAY) position.**

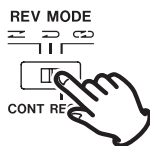

- 3 Press the TAPE 1 deck's RECORD (●) key.**



The deck enters the record-pause mode. **||** and **REC** will light on the display. Now adjust the recording level and any other settings, as required.

- 4 Check the recording direction.**

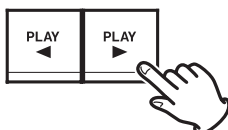

If an indicator is lit which points in the direction opposite to the one desired, change the direction by pressing the opposite direction **PLAY** (◀ or ▶) key.

NOTE

Be careful not to press the **PLAY** (◀ or ▶) key whose arrow points in the same direction as the indicator. Doing so will start recording.

Recording is done in this order:

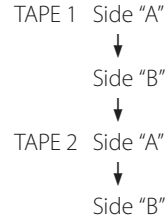

You can start recording from side "B" of TAPE 1. But if you do so, side "A" of this tape is not recorded: when recording reaches the end of side "B", the TAPE 2 deck starts recording.

NOTE

The TAPE 2 deck always starts recording from side "A".

- 5 Start recording.**



Recording starts when you press the **PAUSE** key or the **PLAY** (◀ or ▶) key whose arrow points in the same direction as the indicator on the TAPE 1 deck.

When recording is finished on the TAPE 1 deck, the TAPE 2 deck automatically starts recording.

NOTE

The transition from TAPE 1 to TAPE 2 takes several seconds.

- To stop recording**

Press the **STOP** (■) key of the deck which is currently recording.

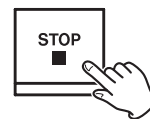

Parallel recording

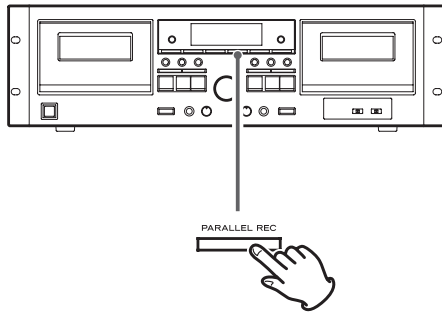

This function allows you to record the same material simultaneously on both TAPE 1 and TAPE 2.

Load tapes into both decks and press the **PARALLEL REC** key to start recording.

Before starting recording, check and correct the following by performing steps 1 – 6 on page 15 such as Record direction, Reverse mode setting, Recording level, etc.

When everything is ready, get back into stop mode if the deck is in another mode.

During parallel recording, the **PARALLEL** indicator is lit on the display.

During parallel recording, only the following keys work:

TAPE 1 deck : **STOP** (■)

TAPE 2 deck : **PAUSE, REC MUTE, STOP** (■)

Pressing the **STOP** (■) key on either deck stops both tapes at once.

Dubbing (from TAPE 1 to TAPE 2)

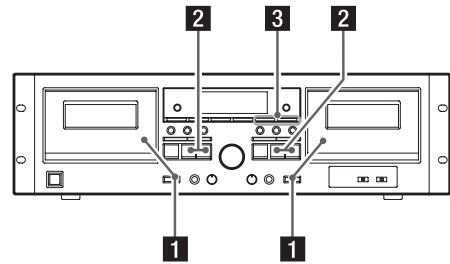

- 1 Insert a cassette tape for playback into the **TAPE 1** compartment and a cassette tape for recording into the **TAPE 2** compartment.

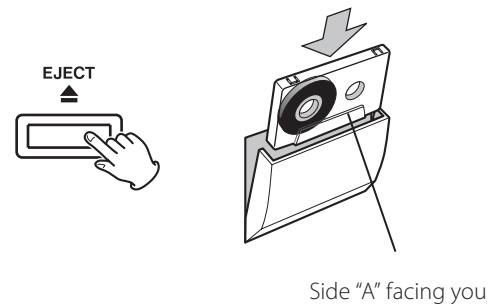

- 2 Set the tape transport direction on both decks.

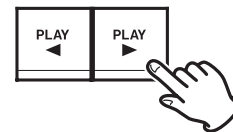

If the play/record direction indicator (◀ / ▶) on the display points in the direction opposite to the one desired, press the **PAUSE** key followed by the **PLAY** (◀ or ▶) key corresponding to the desired direction.

After changing the tape transport direction, be sure to press the **STOP** (■) key to get out of the pause mode.

NOTE

- Be careful not to press the **PLAY** (◀ or ▶) key whose arrow points in the same direction as the indicator. Doing so will start playback.
- Set the **REV MODE** switch as required.

- 3 Press either **DUB START** key to start dubbing.

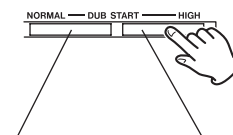

normal speed dubbing start high-speed dubbing start

For normal speed dubbing, press the **NORMAL** key. For high-speed dubbing, press the **HIGH** key.

NOTE

High-speed dubbing makes a copy at approximately two times the normal speed. We recommend normal speed dubbing for best audio quality.

During dubbing, either the **NORM DUB** or **HIGH DUB** indicator lights steadily on the display.

During normal speed dubbing, only the following keys work:

TAPE 1 deck : **STOP** (■)

TAPE 2 deck : **PAUSE, REC MUTE, STOP** (■)

During high-speed dubbing, only the **STOP** (■) key works.

Neither **DUB START** key works immediately after the tape is fast-forwarded or rewound to the end. Wait for 5 seconds or more before pressing the key.

NOTE

- During dubbing, the pitch control does not work.
- Recording level adjustment is not necessary for dubbing, as the recording level is set to the level of the pre-recorded tape. Operating the **INPUT** control, before or after starting dubbing, has no effect at all.
- If a nearby television set is switched on during high-speed dubbing, a high-pitched interference noise may be recorded on the tape. To avoid this, either perform dubbing at normal speed, or turn off the television.

Editing during dubbing (only at normal speed)

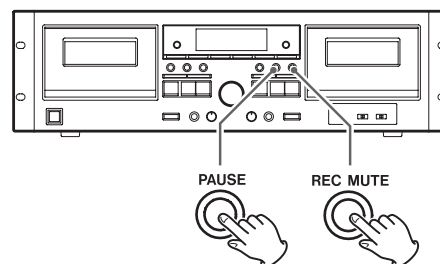

You can prevent unwanted songs or unnecessarily long blanks from being dubbed, or you can create blanks between songs.

1. **At the desired point during dubbing, press the PAUSE key on the TAPE 1 deck. The TAPE 2 deck only enters the pause mode, allowing you to let unwanted songs go by.**

To create a 4-second blank between songs, press the **REC MUTE** key on the TAPE 2 deck. The TAPE 2 deck temporarily stops after recording no signal for 4 seconds.

The TAPE 1 deck continues playback when the TAPE 2 deck is in pause mode.

2. **To resume dubbing, press the PAUSE key on the TAPE 2 deck.**

Synchro reverse dubbing (from TAPE 1 to TAPE 2)

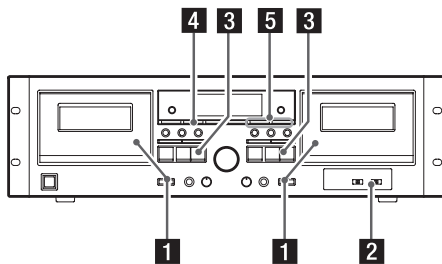

When you use this dubbing function and a shorter tape reaches the end of side "A", it momentarily stops until the other tape reaches the end of side "A". Then both tapes automatically switch over to side "B" and recording and playback re-start simultaneously.

If TAPE 1 is shorter than TAPE 2

When TAPE 1 reaches the end of side "A", TAPE 1 stops and TAPE 2 enters the "blank recording" mode.

When TAPE 2 reaches the end, both TAPE 1 and 2 are reversed simultaneously. TAPE 1 starts playback and TAPE 2 resumes recording.

When TAPE 1 reaches the end of side "B", both TAPE 1 and 2 stop simultaneously.

If TAPE 2 is shorter than TAPE 1

When TAPE 2 reaches the end of side "A", TAPE 2 enters the record-pause mode, while TAPE 1 continues playback.

When TAPE 1 reaches the end, both TAPE 1 and 2 are reversed simultaneously. TAPE 1 starts playback and TAPE 2 resumes recording.

When TAPE 2 reaches the end of side "B", both TAPE 1 and 2 stop simultaneously.

1 Insert a cassette tape for playback into the TAPE 1 compartment and a cassette tape for recording into the TAPE 2 compartment.

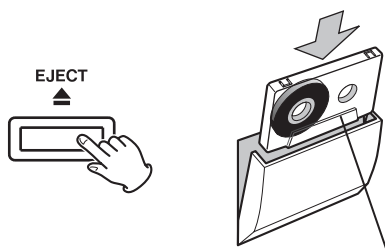

Side "A" facing you

2 Set the REV MODE switch to the two-way (↔) position.



3 Check the recording direction of both decks.



If the reverse direction indicator (◀) lights on the display, press the **PAUSE** key followed by the forward **PLAY** (▶) key. Then, be sure to press the **STOP** (■) key to get out of the pause mode.

NOTE

- Be careful not to press the **PLAY** (◀ or ▶) key whose arrow points in the same direction as the indicator. Doing so will start playback.

4 Press the SYNC REVERSE key.

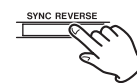

The **SYNC REV** indicator will light on the display.

The **SYNC REVERSE** key does not work if the reverse mode is set to any positions other than ↔ or if the transport direction of both decks is set to reverse (◀).

5 Press either DUB START key to start dubbing.

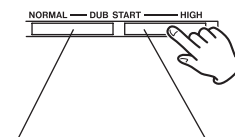

normal speed
dubbing start

high-speed
dubbing start

For normal speed dubbing, press the **NORMAL** key. For high-speed dubbing, press the **HIGH** key.

High-speed dubbing makes a copy at approximately two times the normal speed. We recommend normal speed dubbing for best audio quality.

During dubbing, either the **NORM DUB** or **HIGH DUB** indicator lights steadily on the display.

During normal speed dubbing, only the following keys work:

TAPE 1 deck : **STOP** (■)

TAPE 2 deck : **PAUSE, REC MUTE, STOP** (■)

During high-speed dubbing, only the **STOP** (■) key works.

Pressing the **STOP** (■) key on either deck stops both tapes at once.

Neither **DUB START** key works immediately after the tape is fast-forwarded or rewound to the end. Wait for 5 seconds or more before pressing the key.



NOTE

- During dubbing, the pitch control does not work.
- Recording level adjustment is not necessary for dubbing, as the recording level is set to the level of the pre-recorded tape. Operating the **INPUT** control, before or after starting dubbing, has no effect at all.
- If a nearby television set is switched on during high-speed dubbing, a high-pitched interference noise may be recorded on the tape. To avoid this, either perform dubbing at normal speed, or turn off the television.

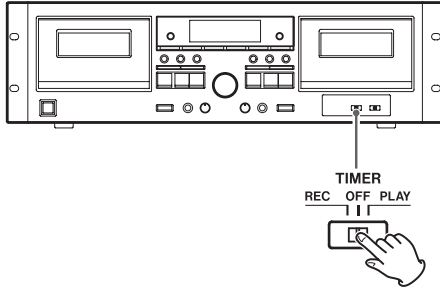
Timer-Controlled Playback and Recording



Timer-Controlled Playback

1. Connect this unit and stereo system to a commercially available audio timer.
2. Set the power switch of all components to ON.
3. Load a prerecorded cassette tape in TAPE 1 or 2. You can also insert tapes into both decks. In this case, TAPE 1 starts first.
4. Set the REV MODE switch to the required position.
If you set the REV MODE switch to :
a tape deck plays only Side "A" of the tape.
 - If a tape is in both the TAPE 1 and TAPE 2 compartments, the TAPE 1 deck plays Side "A" of the tape and then stops.
If a tape is in the TAPE 2 compartment only, the TAPE 2 deck plays Side "A" of the tape.
If you set the REV MODE switch to :
a tape deck continuously plays both sides of the tape.
When the tape deck reaches the end of Side "A" in playback mode, it automatically reverses the tape and continues to play Side "B".
 - If a tape is in both the TAPE 1 and TAPE 2 compartments, the TAPE 1 deck plays both sides of the tape and then stops.
If a tape is in the TAPE 2 compartment only, the TAPE 2 deck plays both sides of the tape.
If you set the REV MODE switch to :
both sides of a tape are continuously played for up to five times.
5. Set the TIMER switch to the PLAY position.
6. Set the audio timer to the required start (power on) and stop (power off) times. When this setting is completed, the power to all components will be switched off.
When a preset start time is reached, power will be supplied and playback will start automatically.
Playback always starts from side "A".

NOTE

- If you directly connect the deck's AC power cord to the AC outlet, playback automatically starts by simply pressing on the **POWER** switch of this deck when you set the **TIMER** switch to the **PLAY** position. When you do not use the timer, set the **TIMER** switch to the **OFF** position.

Timer-controlled recording

(Example: Recording a broadcast program)

1. Connect this unit and stereo system to a commercially available audio timer.
2. Set the power switch of all components to ON.
3. Load a recordable cassette tape(s) in TAPE 1 or 2 (or both decks for continuous recording).
4. Set the REV MODE switch to the required position.

If you set the REV MODE switch to :

a tape deck records on only Side "A" of the tape.

- If a tape is in both the TAPE 1 and TAPE 2 compartments, the TAPE 1 deck records on Side "A" of the tape and then stops.
If a tape is in the TAPE 2 compartment only, the TAPE 2 deck records on Side "A" of the tape.

If you set the REV MODE switch to :

a tape deck continuously records on both sides of the tape.

When the tape deck reaches the end of Side "A" in record mode, it automatically reverses the tape and continues to record on Side "B".

- If a tape is in both the TAPE 1 and TAPE 2 compartments, the TAPE 1 deck records on both sides of the tape and then stops.
If a tape is in the TAPE 2 compartment only, the TAPE 2 deck records on both sides of the tape.

If you set the REV MODE switch to  (continuous recording):

insert a tape into both the TAPE 1 and TAPE 2 compartments. The TAPE 1 and TAPE 2 decks continuously record on the tapes.

5. Tune in a broadcasting station to be recorded.
6. Press the RECORD (●) key of the deck to be recorded to set the deck to the record-pause mode.
7. Adjust the recording level.
8. Set the TIMER switch to the REC position.
9. Set the audio timer to the required start (power on) and stop (power off) times. When this setting is completed, the power to all components will be switched off.

When the preset start time is reached, power will be supplied and recording will start automatically.
Recording always starts from side "A".

CAUTION

If you directly connect the deck's AC power cord to the AC outlet, recording automatically starts by simply pressing on the **POWER** switch of this deck when you set the **TIMER** switch to the **REC** position. When you do not use the timer for a while, be sure to set the **TIMER** switch back to the **OFF** position to prevent accidental erasure of your important tape.

Connections with a timer

Connecting a commercially available timer to your audio setup lets you wake up to your favorite cassette tape, or start recording at specified times.

Refer to the illustration below, and connect your audio components.

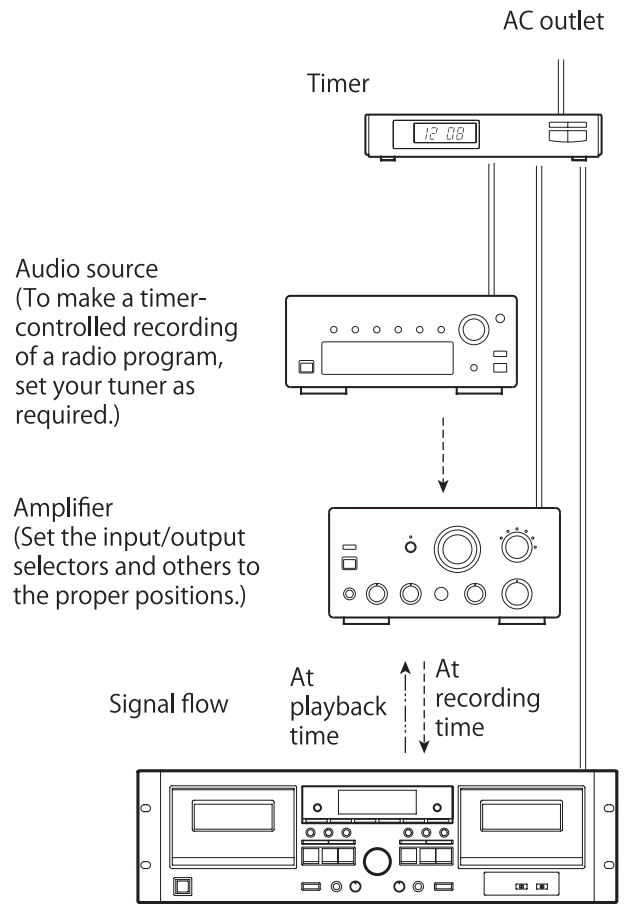

Troubleshooting

If you think that there is anything wrong with this cassette deck, make the checks listed below before contacting a repair service. In some cases the problem may lie with another component. Check all components.

If the problem cannot be solved with any of the following checks, contact your dealer for help.

Cannot switch on the power

- ➔ Check the connection to the AC power supply. Check and make sure the AC source is not a switched outlet and that, if it is, the switch is turned on. Make sure there is power to the AC outlet by plugging another item such as a lamp or fan into the outlet.

No sound

- ➔ Check the connection to the amplifier.
- ➔ Check the amplifier settings.

Noisy playback

- ➔ Keep away from equipment that generates a magnetic field, such as a TV or microwave oven.

Transport control keys do not work.

- ➔ Load a cassette tape if not loaded.
- ➔ If a cassette tape is loaded, reinsert it.

The cassette compartment does not close.

- ➔ The cassette is not properly loaded. Reinsert it.

Poor sound quality

- ➔ Clean the heads.



Cannot record

- ➔ If the erasure prevention tabs on top of the cassette are broken off, cover the holes using pieces of adhesive tape.
- ➔ Check the connection to the amplifier and to the source equipment.
- ➔ Set the amplifier input/output selectors correctly.
- ➔ Check the recording level setting.



Playback speed seems somewhat fast or slow.

- ➔ Check the pitch control setting.

Auto reverse does not occur.

- ➔ Set the **REV MODE** switch to  or .
- ➔ If the **REV MODE** switch is set to , start playback from the tape side facing you (side "A").

Synchro reverse dubbing is not possible.

- ➔ Set the **REV MODE** switch to the  position.
- ➔ Load cassettes into both decks.
- ➔ Set the tape transport direction to  on both decks.

Continuous play/record is not possible.

- ➔ Set the **REV MODE** switch to the  position.
- ➔ Load cassettes into both decks.
- ➔ To make a continuous recording, start with TAPE 1 .

NOTE

This cassette deck operates on a delicate microcomputer and there may be occasions when the deck does not function as expected because of external noise or interference. Problems you encounter on such occasions may be cured by turning off the power, waiting for 1 minute or more, then turning the power back on.

Specifications

Track System.....	4-track, 2-channel stereo
Heads Construction.....	Record/playback head × 1 (each deck) Erase head × 1 (each deck)
Tape Speed.....	4.8 cm/sec 9.5 cm/sec (high-speed dubbing mode)
Pitch Control.....	12%
Fast Winding Time.....	approximately 160 sec (C-60 tape)
Motor.....	DC servo motor (capstan)
Wow and Flutter.....	0.25% (WRMS)
Frequency Response (Overall)	
High position tape (Type II).....	30 Hz–15 kHz (±4 dB)
Normal tape (Type I).....	30 Hz–13 kHz (±4 dB)
Signal to Noise Ratio (Overall).....	58 dB (at maximum recording level input, A-Weight)
ANALOG INPUT jacks (RCA)	
Reference input level.....	0.28 V
Input impedance.....	50 kΩ
MIC input jack (standard mono jack)	
Reference input level.....	0.38 mV
Input impedance.....	47 kΩ
ANALOG OUTPUT jacks (RCA)	
Reference output level.....	0.46 V
Load impedance:.....	50 kΩ or higher
Headphones Output (stereo 1/4" Phone jack).....	2 mW / 32 Ω
Power Requirements.....	U.S.A./Canada AC 120 V, 60 Hz U.K./Europe AC 230 V, 50 Hz
Power Consumption.....	22 W
Dimensions (including protruding parts)	
	483 (W) × 138.4 (H) × 285.8 (D) mm (19" × 5 7/16" × 11 1/4")
Weight.....	5.4 kg (11 7/8 lb)

Dimensions

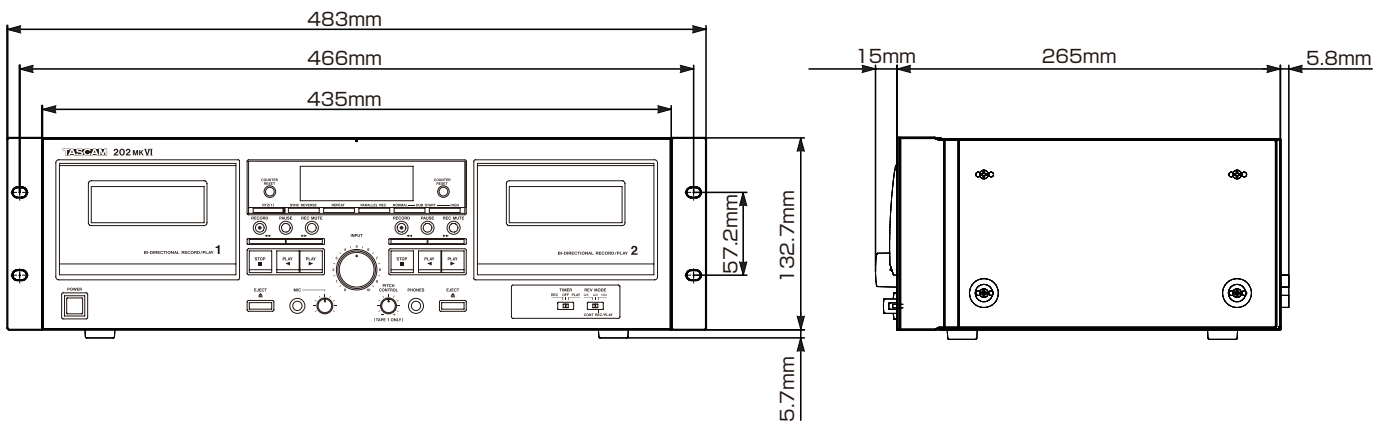

- Illustrations and other depictions may differ in part from the actual product.
- Specifications and external appearance may be changed without notification to improve the product.

WARRANTY

< In the United States >

This warranty gives you specific legal rights and you may also have other rights which vary from state to state. This warranty is only valid within the country the unit was originally purchased.

WHAT IS AND IS NOT COVERED

Except as specified below, this warranty covers all defects in materials and workmanship in this product. The following are not covered by the warranty:

1. **Damage to or deterioration of the external cabinet.**
2. **Damages resulting from accident, misuse, abuse or neglect.**
3. **Damage resulting from failure to perform basic daily maintenance and/or calibration or otherwise resulting from failure to follow instructions contained in your owner's manual.**
4. **Damage occurring during shipment of the product. (Claims must be presented to the carrier)**
5. **Damage resulting from repair or attempted repair by anyone other than TEAC or an authorized TASCAM service station.**
6. **Damage resulting from causes other than product defects, including lack of technical skill, competence, or experience of the user.**
7. **Damage to any unit which has been altered or on which the serial number has been defaced, modified or is missing.**

WHO MAY ENFORCE THE WARRANTY

This warranty may be enforced only by the original purchaser.

LENGTH OF WARRANTY

All parts except heads and disk drives are warranted for one (1) year from the date of original purchase. Heads and disk drives are warranted to ninety (90) days from date of original purchase. Labor is warranted for ninety (90) days from date of original purchase.

WHAT WE WILL PAY FOR

We will pay all labor and material expenses for items covered by the warranty. Payment of shipping charges is discussed in the next section of this warranty.

HOW YOU CAN GET WARRANTY SERVICE

Your unit must be serviced by an authorized TASCAM service station in the United States. (This warranty is not enforceable outside the U.S.) If you are unable to locate an authorized TASCAM service station in your area, please contact us. We either will refer you to an authorized service station or instruct you to return the unit to the factory. Whenever warranty service is required, you must present a copy of the original dated sales receipt from an Authorized TASCAM Dealer.

You must pay any shipping charges if it is necessary to ship the product to service. However, if the necessary repairs are covered by the warranty, we will pay return surface shipping charges to any destination within the United States.

LIMITATION OF IMPLIED WARRANTIES

Any implied warranties, INCLUDING WARRANTIES OF MERCHANTABILITY AND FITNESS FOR A PARTICULAR PURPOSE, are limited in duration to the length of this warranty.

EXCLUSION OF DAMAGES

TEAC's liability for any defective product is limited to repair or replacement of the product, at TEAC's option. TEAC shall not be liable for:

1. **Damages based upon inconvenience, loss of use of the product, loss of time interrupted operation or commercial loss; or**
2. **Any other damages, whether incidental, consequential or otherwise.**

Some states do not allow limitations on how long an implied warranty lasts and/or do not allow the exclusion or limitation of incidental or consequential damages, so the above limitations and exclusions may not apply to you.

To locate an Authorized Service Center in Your Area

CALL 1-800-447-8322

< Europe >

This product is subject to the legal warranty regulations of the country of purchase. In case of a defect or a problem, please contact the dealer where you bought the product.

Ce produit est sujet aux réglementations concernant la garantie légale dans le pays d'achat. En cas de défaut ou de problème, veuillez contacter le revendeur chez qui vous avez acheté le produit.

Dieses Gerät unterliegt den gesetzlichen Gewährleistungsbestimmungen des Landes, in dem es erworben wurde. Bitte wenden Sie sich im Gewährleistungsfall an den Händler, bei dem sie das Gerät erworben haben.

Questo apparecchio è conforme alle norme sulla garanzia vigenti nel rispettivo Paese in cui esso è stato acquistato. Si prega di rivolgersi al proprio commerciante, presso il quale è stato acquistato l'apparecchio, nel caso in cui si voglia richiedere una prestazione in garanzia.

Las condiciones de garantía de este aparato están sujetas a las disposiciones legales sobre garantía del país en el que ha sido adquirido. En caso de garantía, debe dirigirse al establecimiento donde adquirió el aparato.

< In other countries/areas >

This warranty gives you specific legal rights, and you may also have other rights that vary by country, state or province.

If you have a warranty claim or request, please contact the dealer where you bought the product.

该保证书赋予了顾客特定的合法权利，并且因国家、州或省等地域的不同，顾客可能拥有其他权利。如需申请或要求保修，请与购买本产品的销售店进行联系。

If you require repair services for your TASCAM equipment, please contact the dealer where the product was purchased from or the TASCAM Distributor in your country. A list of TASCAM Distributors can be found on our website at: <http://teac-global.com/>

TASCAM

TEAC CORPORATION

Phone: +81-42-356-9143

1-47 Ochiai, Tama-shi, Tokyo 206-8530 Japan

<http://tascam.jp/>

TEAC AMERICA, INC.

Phone: +1-323-726-0303

1834 Gage Road, Montebello, California 90640 USA

<http://tascam.com/>

TEAC MEXICO, S.A. de C.V.

Phone: +52-55-5010-6000

Río Churubusco 364, Colonia Del Carmen, Delegación Coyoacán, CP 04100, México DF, México

<http://teacmexico.net/>

TEAC UK LIMITED

Phone: +44-8451-302511

Meridien House, Ground Floor, 69 - 71, Clarendon Road, Watford, Hertfordshire, WD17 1DS, UK

<http://tascam.eu/>

TEAC EUROPE GmbH

Phone: +49-611-71580

Bahnstrasse 12, 65205 Wiesbaden-Erbenheim, Germany

<http://tascam.eu/>

TEAC SALES & TRADING(SHENZHEN) CO., LTD

Phone: +86-755-88311561~2

Room 817, Block A, Hailrun Complex, 6021 Shennan Blvd., Futian District, Shenzhen 518040, China

<http://tascam.cn/>

Printed in China

WARRANTY

Model/Modèle/Modell
Model/Modèle/Modell

Sample
202MKT1

Owner's name/Nom du possesseur/Name des Eigentümers
Nome del proprietario/Nombre del propietario/顾客姓名

Serial No./No de Série/Seriennummer
Numero di serie/Número de serie/序列号

Address/Adresse/Adresse
Indirizzo/Dirección/顾客地址

Date of purchase/Date de l'achat/Datum des Kaufs
Data dell'acquisto/Fecha de compra/购买日期

Dealer's name/Nom du détaillant/Name des Händlers
Nome del commerciante/Nombre del establecimiento/销售店名

TASCAM
<http://teac-global.com/>

Dealer's address/Adresse du détaillant/Adresse des Händlers
Indirizzo del commerciante/Dirección del establecimiento/销售店地址

Free Manuals Download Website

<http://myh66.com>

<http://usermanuals.us>

<http://www.somanuals.com>

<http://www.4manuals.cc>

<http://www.manual-lib.com>

<http://www.404manual.com>

<http://www.luxmanual.com>

<http://aubethermostatmanual.com>

Golf course search by state

<http://golfingnear.com>

Email search by domain

<http://emailbydomain.com>

Auto manuals search

<http://auto.somanuals.com>

TV manuals search

<http://tv.somanuals.com>