

TASCAM

D01229220A

CG-1800

CG-1000

Master Clock Generator

OWNER'S MANUAL

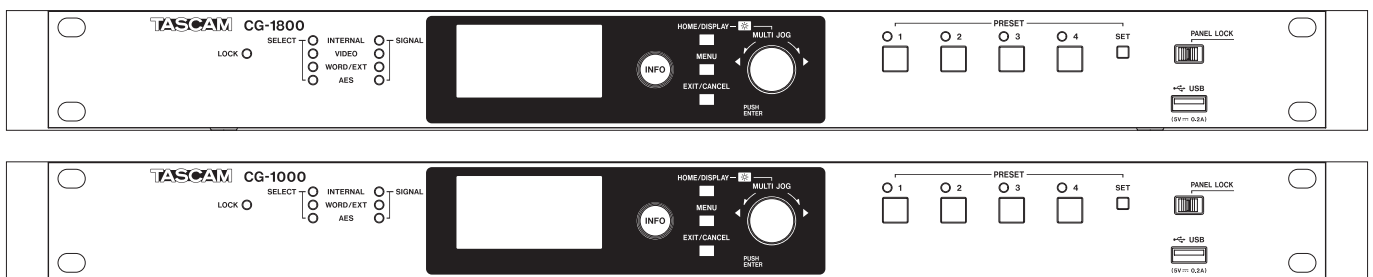

IMPORTANT SAFETY PRECAUTIONS



CAUTION: TO REDUCE THE RISK OF ELECTRIC SHOCK, DO NOT REMOVE COVER (OR BACK). NO USER-SERVICEABLE PARTS INSIDE. REFER SERVICING TO QUALIFIED SERVICE PERSONNEL.



The lightning flash with arrowhead symbol, within equilateral triangle, is intended to alert the user to the presence of uninsulated "dangerous voltage" within the product's enclosure that may be of sufficient magnitude to constitute a risk of electric shock to persons.



The exclamation point within an equilateral triangle is intended to alert the user to the presence of important operating and maintenance (servicing) instructions in the literature accompanying the appliance.

WARNING: TO PREVENT FIRE OR SHOCK HAZARD, DO NOT EXPOSE THIS APPLIANCE TO RAIN OR MOISTURE.

— For U.S.A. —

This equipment complies with Part 15 of FCC Rules. Operation is subject to the following two conditions:

- 1) This device may not cause interference and
- 2) This device must accept any interference, including interference that may cause undesired operation of the device.

INFORMATION TO THE USER

This equipment has been tested and found to comply with the limits for a Class A digital device, pursuant to Part 15 of the FCC Rules. These limits are designed to provide reasonable protection against harmful interference when the equipment is operated in a commercial environment. This equipment generates, uses, and can radiate radio frequency energy and, if not installed and used in accordance with the instruction manual, may cause harmful interference to radio communications.

Operation of this equipment in a residential area is likely to cause harmful interference in which case the user will be required to correct the interference at his own expense.

CAUTION

Changes or modifications to this equipment not expressly approved by TEAC CORPORATION for compliance could void the user's authority to operate this equipment.

IN USA/CANADA, USE ONLY ON 120 V SUPPLY.

For Canada

THIS CLASS A DIGITAL APPARATUS COMPLIES WITH CANADIAN ICES-003.CET

APPAREIL NUMERIQUE DE LA CLASSE A EST CONFORME A LA NORME NMB-003 DU CANADA.

CE Marking Information

- a) Applicable electromagnetic environment: E4
- b) The average half-cycle r.m.s. inrush current
 1. On initial switch-on: N/A
 2. After a supply interruption of 5s: 1.7 Arms

For the customers in Europe

WARNING

This is a Class A product. In a domestic environment, this product may cause radio interference in which case the user may be required to take adequate measures.

Pour les utilisateurs en Europe

AVERTISSEMENT

Il s'agit d'un produit de Classe A. Dans un environnement domestique, cet appareil peut provoquer des interférences radio, dans ce cas l'utilisateur peut être amené à prendre des mesures appropriées.

Für Kunden in Europa

Warnung

Dies ist eine Einrichtung, welche die Funk-Entstörung nach Klasse A besitzt. Diese Einrichtung kann im Wohnbereich Funkstörungen verursachen; in diesem Fall kann vom Betreiber verlangt werden, angemessene Maßnahmen durchzuführen und dafür aufzukommen.

DECLARATION OF CONFORMITY

We, TEAC EUROPE GmbH, Bahnstrasse 12, 65205 Wiesbaden-Erbenheim, Germany declare in own responsibility, the TEAC product described in this manual is in compliance with the corresponding technical standards.



IMPORTANT SAFETY INSTRUCTIONS

- 1 Read these instructions.
- 2 Keep these instructions.
- 3 Heed all warnings.
- 4 Follow all instructions.
- 5 Do not use this apparatus near water.
- 6 Clean only with dry cloth.
- 7 Do not block any ventilation openings. Install in accordance with the manufacturer's instructions.
- 8 Do not install near any heat sources such as radiators, heat registers, stoves, or other apparatus (including amplifiers) that produce heat.
- 9 Do not defeat the safety purpose of the polarized or grounding-type plug. A polarized plug has two blades with one wider than the other. A grounding type plug has two blades and a third grounding prong. The wide blade or the third prong are provided for your safety. If the provided plug does not fit into your outlet, consult an electrician for replacement of the obsolete outlet.
- 10 Protect the power cord from being walked on or pinched particularly at plugs, convenience receptacles, and the point where they exit from the apparatus.
- 11 Only use attachments/accessories specified by the manufacturer.
- 12 Use only with the cart, stand, tripod, bracket, or table specified by the manufacturer, or sold with the apparatus. When a cart is used, use caution when moving the cart/apparatus combination to avoid injury from tip-over.



- 13 Unplug this apparatus during lightning storms or when unused for long periods of time.
- 14 Refer all servicing to qualified service personnel. Servicing is required when the apparatus has been damaged in any way, such as power-supply cord or plug is damaged, liquid has been spilled or objects have fallen into the apparatus, the apparatus has been exposed to rain or moisture, does not operate normally, or has been dropped.

- The apparatus draws nominal non-operating power from the AC outlet with its POWER or STANDBY/ON switch not in the ON position.
- The mains plug is used as the disconnect device, the disconnect device shall remain readily operable.
- Caution should be taken when using earphones or headphones with the product because excessive sound pressure (volume) from earphones or headphones can cause hearing loss.
- If you are experiencing problems with this product, contact TEAC for a service referral. Do not use the product until it has been repaired.

CAUTION

- Do not expose this apparatus to drips or splashes.
- Do not place any objects filled with liquids, such as vases, on the apparatus.
- Do not install this apparatus in a confined space such as a book case or similar unit.
- The apparatus should be located close enough to the AC outlet so that you can easily grasp the power cord plug at any time.
- If the product uses batteries (including a battery pack or installed batteries), they should not be exposed to sunshine, fire or excessive heat.
- CAUTION for products that use replaceable lithium batteries: there is danger of explosion if a battery is replaced with an incorrect type of battery. Replace only with the same or equivalent type.

WARNING

- Products with Class I construction are equipped with a power supply cord that has a grounding plug. The cord of such a product must be plugged into an AC outlet that has a protective grounding connection.

■ RACK-MOUNTING THE UNIT

Use the supplied rack-mounting kit to mount the unit in a standard 19-inch rack, as shown below.

Remove the feet of the unit before mounting.

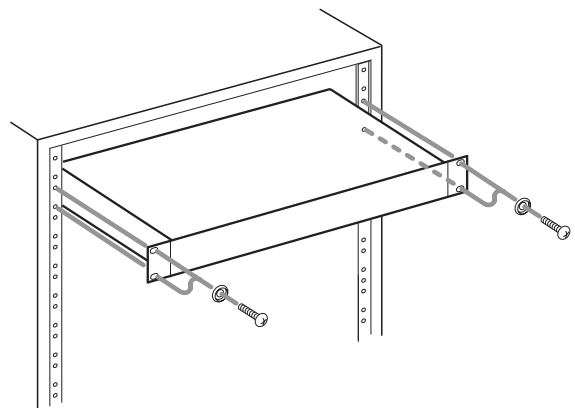

CAUTION

- Leave 1U of space above the unit for ventilation.
- Allow at least 10 cm (4 in) at the rear of the unit for ventilation.

Safety Information

■ For European Customers

Disposal of electrical and electronic equipment

- (a) All electrical and electronic equipment should be disposed of separately from the municipal waste stream via designated collection facilities appointed by the government or the local authorities.
- (b) By disposing of the electrical and electronic equipment correctly, you will help save valuable resources and prevent any potential negative effects on human health and the environment.
- (c) Improper disposal of waste equipment can have serious effects on the environment and human health as a result of the presence of hazardous substances in electrical and electronic equipment.
- (d) The crossed out wheeled dust bin symbol indicates that electrical and electronic equipment must be collected and disposed of separately from household waste.



- (e) The return and collection systems are available to the end users. For more detailed information about disposal of old electrical and electronic equipment, please contact your city office, waste disposal service or the shop where you purchased the equipment.

■ For China



“仅适用于海拔 2000m 以下地区安全使用”



“仅适用于非热带气候条件下安全使用”



“环境保护使用年限”

产品有毒有害物质或元素的名称及含量

机种：CG-1800/CG-1000		有毒有害物质或元素					
	品名	铅 (Pb)	汞 (Hg)	镉 (Cd)	六价铬 (Cr6+)	多溴联苯 (PBB)	多溴二苯醚 (PBDE)
1	CHASSIS 部份	○	○	○	○	○	○
2	FRONT PANEL 部份	○	○	○	○	○	○
3	螺丝部份	○	○	○	○	○	○
4	线材部份	○	○	○	○	○	○
5	PCB Assy 部份	×	○	○	○	○	○
6	电源部份	○	○	○	○	○	○
7	附属品部份	×	○	○	○	○	○
8	LABEL 部份	○	○	○	○	○	○
9	包装部份	○	○	○	○	○	○

○：表示该有毒有害物质在该部件所有均质材料中的含量均在 SJ/T11363-2006 标准规定的限量要求以下。

×：表示该有毒有害物质至少在该部件的某一均质材料中的含量超出 SJ/T11363-2006 标准规定的限量要求。

(针对现在代替技术困难的电子部品及合金中的铅)

1 – Introduction	6		
Features	6		
Included items	6		
Conventions used in this manual	6		
Trademarks.....	6		
Precautions for placement	7		
Power supplies.....	7		
Condensation	7		
Cleaning the unit.....	7		
USB flash drives.....	7		
Handling precautions.....	7		
Using the TEAC Global Site.....	7		
User registration.....	7		
2 – Names and functions of parts	8		
Front panel	8		
Rear panel	9		
Home Screen	10		
Information screen	10		
INFO button indicator status	10		
Operation status display (button lit blue)	10		
Error information screen (button lit red)	11		
Menu structure	11		
Basic menu screen operation	12		
Menu operation procedures.....	13		
3 – Preparation.....	14		
Making connections	14		
Turning the power on/off.....	15		
Setting the date and time.....	15		
Adjusting the brightness.....	15		
Adjusting the brightness from the menu.....	15		
Adjusting the brightness with the HOME/ DISPLAY button and MULTI JOG dial.....	15		
4 – Basic settings.....	16		
Setting the reference clock	16		
Setting the video clock (CG-1800 only).....	16		
Setting the video format	16		
Setting the video frame rate.....	16		
Enabling automatic video frame rate setting..	16		
Setting the force relock mode (CG-1800 only)	16		
Setting the audio clock.....	17		
Setting the audio clock frequency.....	17		
Setting audio clock frequency pull-up/ pull-down (CG-1800 only)	17		
Enabling automatic audio clock frequency setting	17		
Setting the audio clock frequency multiplier for the WORD 11/12 OUTPUTS.....	18		
		Setting the output format for AES 3/11 and S/PDIF output connectors.....	18
		Setting the output format for AES 3/11 outputs.....	18
		Setting the output format for S/PDIF outputs	18
5 – Preset function	19		
Saving the current settings as a preset.....	19		
Saving procedure.....	19		
Recalling presets	19		
Recall procedure.....	19		
Restoring presets to their factory defaults.....	19		
6 – Operations using USB flash drives	20		
Overview	20		
Connecting/disconnecting USB flash drives	20		
Connecting a USB flash drive.....	20		
Disconnecting a USB flash drive	20		
Exporting presets to USB flash drives	20		
Importing presets from USB flash drives.....	21		
Exporting the operation log	22		
7 – Analyze function	23		
Using the analyze function.....	23		
8 – Other functions	24		
Setting the termination for reference input connec- tors	24		
Setting the levels of the word clock outputs	24		
Restoring factory default settings	24		
Setting the startup preset	25		
Calibrating the internal oscillator.....	25		
Checking the unit firmware version.....	25		
Checking the error log	25		
Default setting values list.....	26		
9 – Specifications	27		
Inputs and outputs.....	27		
Performance	27		
General	28		
Dimensional drawings	28		

1 – Introduction

Thank you very much for purchasing a TASCAM CG-1800/CG-1000 Master Clock Generator.

Before using this unit, please read this manual thoroughly to ensure you understand how to operate it correctly. We hope that you will enjoy using this unit for many years.

After you have finished reading this Owner's Manual, please keep it in a convenient place for future reference. You can also download a copy of this manual from the TEAC Global Site (<http://teac-global.com/>).

Features

- Internal oscillation element uses a high-precision OCXO (oven-controlled crystal oscillator), which is not affected by environmental temperature
- Creating systems with even higher precision is possible using an external input connector that supports 10MHz
- Jitter management circuit provide stable clock
- Glitch-free relocking circuit prevents noise and skipping during clock dropouts and recovery
- Numerous output connectors, including 12 word clock outputs, enable use even in large-scale video/audio synchronization systems
- Supports input and output of a variety of video signal formats, including NTSC, PAL and HD tri-level (CG-1800 only)
- AES3 and AES11 signals can also be used for external master clock input sources
- Analyze function can measure output device termination (CG-1800 only)
- Word clock output level adjustment function allows signals to be provided to other devices at optimal levels
- Self-calibration function using an external oscillator (atomic/GPS 10MHz, GPS PPS)*
- Word clock up to 192 kHz supported
- Supports 0.1% PULL UP/DOWN between 24F (Film) and 29.97F (NTSC) and 4% PULL UP/DOWN between 24F (Film) and 25F (PAL) (CG-1800 only)
- Up to 4 system settings can be saved to buttons for recall, and saved settings can be imported and exported via USB
- Tough nut-coupling BNC connectors made by Amphenol
- Construction uses independent circuit boards for each connector to prevent contact failures due to twisting
- Three-prong inlet type power cable included
- Panel-lock switch to prevent misoperation
- 128x64-pixel organic EL display with a wide viewing angle
- Aluminum front panel that matches other studio equipment
- Firmware updates possible using the USB port
- EIA 1U rackmount size
- RoHS-compliant

*Use of the self-calibration function requires preparation of a separate PPS-output 10MHz oscillator with a built-in GPS antenna.

Included items

This product includes the following items.

When opening the package, be careful to prevent damaging the items. Keep the box and packing materials for transportation in the future.

Please contact TASCAM if any of these items are missing or have been damaged during transportation.

- Main unit× 1
- Power cord.....× 1
- Rackmount screw kit.....× 1
- Owner's manual (this document).....× 1

The warranty is included at the end of this manual.

Conventions used in this manual

The following conventions are used in this manual.

- Buttons, connectors and other physical parts of this unit are written using a bold font like this: **MENU** button.
- Text displayed on the display of the unit appears like this: REFERENCE.
- The location highlighted (light on dark) on the display is referred to as the "cursor" in some cases.
- The sampling frequency used for the audio clock is called the "audio clock frequency".
- Additional information is provided as necessary in tips, notes and cautions

TIP

These are tips about how to use the unit.

NOTE

These include additional explanations and special cases.

CAUTION

Failure to follow these instructions could result in injury, equipment damage or lost data, for example.

Trademarks

- TASCAM is a trademark of TEAC Corporation, registered in the U.S. and other countries.
- Other company names, product names and logos in this document are the trademarks or registered trademarks of their respective owners.

Precautions for placement

- The guaranteed operating temperature of this unit is between 0 °C and 40 °C (32 °F and 104 °F).
- Do not install the unit in the following types of places. Doing so could degrade its performance or cause malfunction.
 - Places with frequent vibrations
 - Near windows or other places exposed to direct sunlight
 - Near heaters or other extremely hot places
 - Extremely cold places
 - Places with high humidity or bad ventilation
 - Very dusty places
- To assure good heat dissipation, do not place anything on top of the unit.
- Do not place this unit on top of any heat-generating device such as a power amplifier.

Power supplies

- Insert the included power cord completely into the AC IN connector.
- Connect the unit to the standard power outlet.
- Hold a power cord by its plug when connecting and disconnecting it.
- When connecting two power supplies for power redundancy, use separate power circuits that do not affect each other.

Condensation

Condensation could occur if this unit is moved from a cold place to a warm place, is used immediately after a cold room has been heated or is otherwise exposed to a sudden temperature change. If condensation occurs, leave the unit for one or two hours before supplying power to it.

Cleaning the unit

To clean the unit, wipe it gently with a soft dry cloth. Do not wipe the unit with chemical cleaning cloths, benzene, paint thinner, alcohol or other chemical agents because they could damage its surface or cause discoloration.

USB flash drives

USB flash drives can be used with this unit.

A list of USB flash drives that have been confirmed to operate with this produce is available on the TEAC Global Site (<http://teac-global.com/>).

Handling precautions

USB flash drives are made with precision.

In order to avoid damaging them, please observe the following precautions when handling them.

- Do not leave them in places that are extremely hot or cold.
- Do not leave them in places that are extremely humid.
- Do not get them wet.
- Do not place objects on top of them or twist them.

- Do not subject them to strong impacts.
- Do not insert or remove them during data transfer or at other times they are being accessed by the unit.
- When transporting them, put them inside cases or otherwise cover them.

Using the TEAC Global Site

You can download the Owner's Manual necessary for this unit from the TEAC Global Site (<http://teac-global.com/>).

1. Open the TEAC Global Site (<http://teac-global.com/>).
2. In the TASCAM Downloads section, click the desired language to open the Downloads website page for that language.

NOTE

If the desired language does not appear, click Other Languages.

3. Click the product name in the "Search by Model Name" section to open the Downloads page for that product.
4. Select and download the Owner's Manual that are needed.

User registration

Customers in the USA, please visit the TASCAM website (<http://tascam.com/>) to register as a user online.

2 – Names and functions of parts

Front panel

■ CG-1800 Front panel

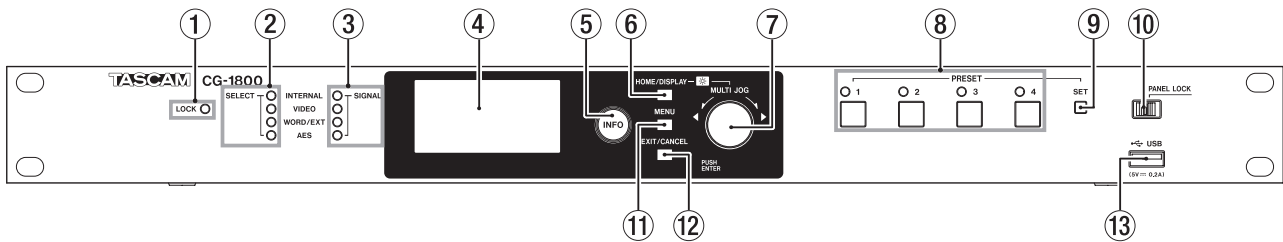

■ CG-1000 Front panel

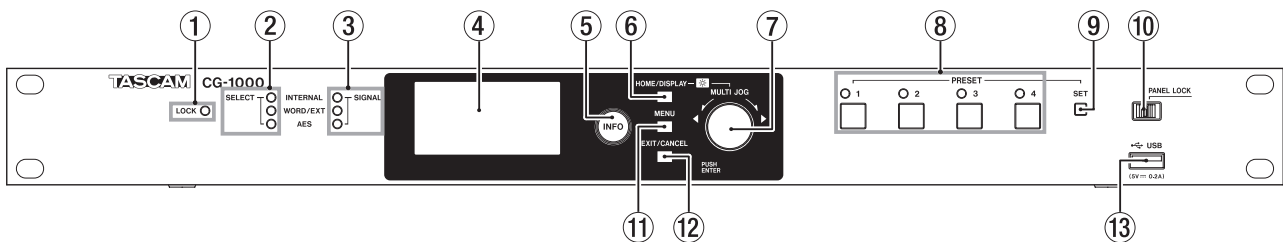

① LOCK indicator

This shows if the output clock and reference clock are locked.

Lit: The output clock phase is synchronized with the reference clock phase.

Blinking: The output clock phase is not synchronized with the reference clock phase.

Examples:

- When the reference clock is being chased when it is switched by the reference redundancy function
- When the backup reference clock is operating

② SELECT reference clock indicators

This shows the selected reference clock and its operation status.

Lit: Now selected and used for reference (including secondary)

Blinking: Selected for reference, but not being used

Unlit: Reference clock that is neither selected nor being used

③ SIGNAL indicators

This shows the input status of each reference clock signal.

Lit: Clock is being input and is locked

Blinking: Clock is being input but is not locked

Unlit: Clock is not being input

NOTE

The INTERNAL indicator will blink to show the temperature of the constant temperature control tank is unstable for about three minutes after the OCXO (oven-controlled crystal oscillator) is started as well as if the temperature of the constant temperature control tank is irregular.

④ Display

This shows various information.

⑤ INFO indicator/button

Lit blue: Indicates ordinary operation. Press the **INFO** button to show the status of the unit on the display.

Lit red: Indicates trouble. Press the **INFO** button to show information about the error on the display. Press again to show the status of the unit.

⑥ HOME/DISPLAY button

Press when a menu screen is open to return to the Home Screen.

While pressing and holding this button, turn the **MULTI JOG** dial to adjust the brightness of the display and the various indicators.

⑦ MULTI JOG dial

This dial also functions as a button.

Dial functions

In menu mode, use to select menu items and setting values.

While pressing and holding the **HOME/DISPLAY** button, turn the **MULTI JOG** dial to adjust the brightness of the display and the various indicators.

When the **INFORMATION** screen or the **ERROR INFORMATION** screen is open, turn the **MULTI JOG** dial to scroll through various information.

Button function

Use as the **ENTER** button to confirm selections and settings.

⑧ PRESET indicators/buttons (1–4)

Use these buttons to save and recall preset settings. (See "Recalling presets" on page 18.)

Ordinarily, the indicator for the button of the most recently recalled preset is lit

⑨ SET button

Press to save the current settings to one of the **PRESET** buttons. (See "Saving the current settings as a preset" on page 18.)

2 – Names and functions of parts

- ⑩ **PANEL LOCK switch**
Slide this switch to the right to disable all operation from the front panel. To enable operation from the front panel, slide this switch to the left.

NOTE

The **INFO** and **HOME** buttons, as well as the **INFORMATION** and **ERROR** Information screens can still be used.

- ⑪ **MENU button**
When the Home Screen is open, press this button to open the menu screen.

- ⑫ **EXIT/CANCEL button**
When a setting screen is open, press this button to go back one level in the menu.
When a pop-up message appears, press this button to answer "NO".

- ⑬ **USB port**
Use to connect USB flash drives.
By connecting a USB flash drive, you can export and import presets and output operation logs.

Rear panel

■ CG-1800 Rear panel

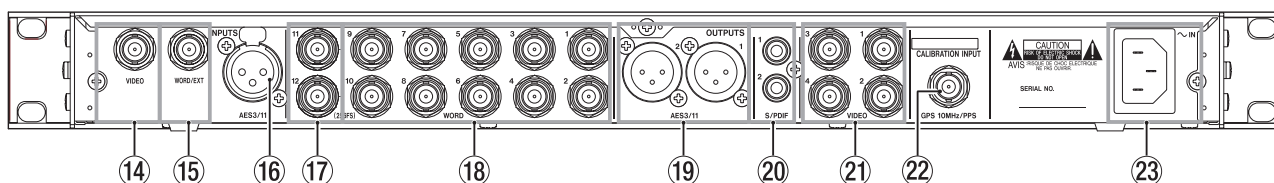

■ CG-1000 Rear panel

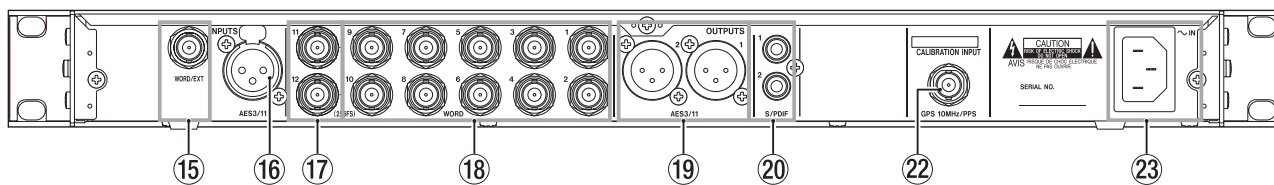

- ⑭ **VIDEO INPUTS (BNC connectors) (CG-1800 only)**
These are video clock input connectors.
- ⑮ **WORD/EXT INPUTS (BNC connectors)**
These are word clock/10MHz clock input connectors
- ⑯ **AES3/11 INPUT (balanced XLR connector)**
When using an AES3 or AES11 signal as reference clock, input the signal through this connector.
- ⑰ **WORD 11/12 (256Fs) OUTPUTS (BNC connectors)**
These are word clock output connectors.
These output word clock signals based on the audio clock generated by this unit.
Using the menu setting, you can also set these to output signals with a $\times 256$ Fs.
- ⑱ **WORD 1-10 OUTPUTS (BNC connectors)**
These are word clock output connectors.
These output word clock signals based on the audio clock generated by this unit.
- ⑲ **AES3/11 1/2 OUTPUTS (balanced XLR connectors)**
These output AES3/11 signals based on the audio clock generated by this unit.
- ⑳ **S/PDIF 1/2 OUTPUTS (RCA pin jacks)**
These output S/PDIF signals based on the audio clock generated by this unit.
- ㉑ **VIDEO 1-4 OUTPUTS (BNC connectors) (CG-1800 only)**
These are video clock output connectors.
These output video clock signals based on the video clock generated by this unit.
- ㉒ **CALIBRATION INPUT (BNC connector)**
When calibrating this unit's internal oscillator, input a calibration signal (10MHz signal generated from a GPS signal, PPS signal, etc.) through this connector.
- ㉓ **AC IN connector**
Connect the included power cord here.

2 – Names and functions of parts

Home Screen

The display of this unit usually shows the following information.



CG-1800



CG-1000

- ① **Reference clock**
This shows the currently selected reference clock.
- ② **Video clock format (CG-1800 only)**
This shows the format setting for the video clock output from this unit.
- ③ **Video clock frame rate (CG-1800 only)**
This shows the frame rate setting for the video clock output from this unit.
- ④ **Audio clock frequency**
This shows the audio clock frequency generated by this unit.
- ⑤ **Pull-up/pull-down (CG-1800 only)**
This shows the pull-up or pull-down setting as a percentage that is applied to the audio clock frequency generated by this unit (④).

Information screen

INFO button indicator status

Blue

During ordinary operation, the **INFO** button indicator lights blue. When blue, press it to show information about the current operation status on the display.

Red

When trouble occurs with the unit, the **INFO** button indicator lights red. When red, press it to show information about the error on the display. Press it again to show information about the current operation status.

Operation status display (button lit blue)

During ordinary operation (lit blue), press the **INFO** button to show information about the current operation status on the display.

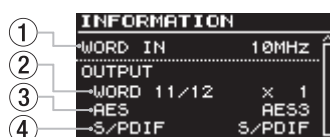

Example of display when reference redundancy function is on

- ① **WORD IN**
This only appears when a 10MHz master clock signal is being received through the word clock input connector.
- ② **WORD OUT 11/12**
This shows the multiplier setting for the word clock output from the **WORD 11/12 OUTPUTS**.
- ③ **AES output format**
This shows the format setting for the digital audio clock signal output from the **AES3/11 1/2 OUTPUTS** (balanced XLR).
- ④ **S/PDIF output format**
This shows the format setting for the digital audio clock signal output from the **S/PDIF 1/2 OUTPUTS** (RCA pin jacks).

Error information screen (button lit red)

When trouble occurs with the unit, the **INFO** button lights red. Press it to show the following information about the trouble on the display.

■ Display of errors occurring currently

Trouble that is occurring currently is shown one item per line.

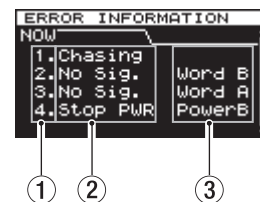

Example of current error display

- ① **Order number**
Numbers assigned to errors in the order of occurrence.
- ② **Error details**
This shows the error code and signal affected as described in the Overview of error codes table below. (See "Overview of error codes" on page 10.)
- ③ **Signal with error**
This shows the signal with which the error occurred.

■ Overview of error codes

The error codes that appear on the **ERROR INFORMATION** screen are as follows.

Error code shown	Error code explanation	Signal affected by error
Unlock	The operation reference signal became unlocked, and the unit switched to the secondary reference clock or backup reference clock.	WORD
		VIDEO
		AES
No Signal	There is no operation reference signal being input, so the unit switched to the secondary reference clock or backup reference clock.	WORD
		VIDEO
		AES
Chasing	Switching reference clock. (This is not listed in the display of errors occurring currently.)	WORD
		VIDEO
		AES
		INTERNAL

2 – Names and functions of parts

Menu structure

Press the **MENU** button to open the **REFERENCE** page of the menu screen.



The menu screen has eight pages with different categories of items.

- REFERENCE page: Make reference clock settings
- VIDEO CLOCK page (CG-1800 only): Make video clock settings
- AUDIO CLOCK page: Make audio clock settings
- TERMINATION page: Make input connector termination settings
- WORD OUT LEVEL page: Set output levels for WORD OUTPUTS
- UTILITY 1 page: Make unit system settings, etc. (1)
- UTILITY 2 page: Make unit system settings, etc. (2)
- LOG page: View and export error logs, etc.

The menu items are as follows.

Menu item	Function	Reference page
SELECT	Select reference clock	page 15
FORCE RELOCK	Set the force relock mode	page 15
FORMAT (CG-1800 only)	Set video clock format	page 15
FRAME RATE (CG-1800 only)	Set video clock frame rate	page 15
AUTO RATE (CG-1800 only)	Turn video clock automatic frame rate setting function on/off	page 15
SAMPLE	Set audio clock frequency	page 16
PULL UP/DOWN (CG-1800 only)	Set audio clock frequency pull-up/pull-down	page 16
AUTO RATE	Turn automatic audio clock frequency setting function on/off	page 16
WORD 11/12	Set sampling frequency multiplier for audio output from WORD 11/12 OUTPUTS	page 17
AES	Set AES3/11 connector (balanced XLR) output format	page 17
S/PDIF	Set S/PDIF connector (RCA pin jack) output format	page 17
VIDEO (CG-1800 only)	Set VIDEO INPUTS termination	page 23
WORD	Set WORD/EXT INPUTS termination	
GPS	Set CALIBRATION INPUT termination	page 23
1/2	Set output level of WORD 1/2 OUTPUTS	
3/4	Set output level of WORD 3/4 OUTPUTS	
5/6	Set output level of WORD 5/6 OUTPUTS	
7/8	Set output level of WORD 7/8 OUTPUTS	
9/10	Set output level of WORD 9/10 OUTPUTS	page 23
11/12	Set output level of WORD 11/12 OUTPUTS	
CLOCK ADJST	Set date and time	page 14
BRIGHTNESS	Adjust indicator brightness	page 14
FACTORY PRESET	Restore unit to factory default settings	page 23
STARTUP	Set the startup preset	page 24
PRESET IMP/EXPORT	Import and export presets	page 19 page 20
ANALYZE	Use analyze function	page 22
VERSION	Check firmware version and update firmware	page 24
LOG EXPORT	Export operation logs	page 21
ERROR LOG	View error logs	—

NOTE

For details about the factory default settings, see "Default setting values list" on page 25.

2 – Names and functions of parts

Basic menu screen operation

Follow these procedures to use the menu screen pages.

To switch items one page at a time:

Press the **MENU** button repeatedly until the desired menu page opens.



The pages appear in the following order.

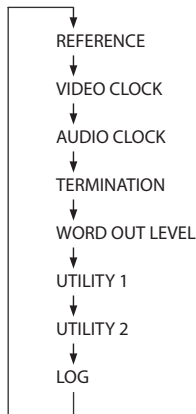

To select an item (up and down on screen):

Turn the **MULTI JOG** dial.



To confirm the selected item:

Press the **MULTI JOG** dial.

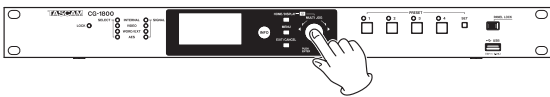

To open a submenu not shown on screen:

Press the **MULTI JOG** dial.

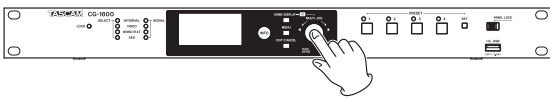

To move up one level in the menu or return to the menu:

Press the **EXIT/CANCEL** button.

To return directly to the Home Screen from menu mode:

Press the **HOME/DISPLAY** button.

Menu operation procedures

In this example, we explain how to set the dedicated connector termination when inputting a calibration signal from a GPS signal.

1. Press the **MENU** button to open the **REFERENCE** menu page.



2. Press the **MENU** button again to open other pages (three times to open **TERMINATION**).

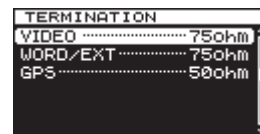

TERMINATION page open

3. Turn the **MULTI JOG** dial to select the item (**GPS**).



GPS selected

4. Press the **MULTI JOG** dial to open the item's setting page (**TERMINATION GPS**).

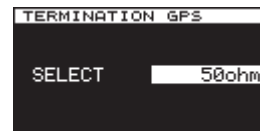

GPS page open

5. Turn the **MULTI JOG** dial to change the setting.
6. Press the **MULTI JOG** dial to confirm the setting.
7. Repeat steps 5–6 as necessary to set other items.
8. Press the **MULTI JOG** dial to return to the menu screen. Press the **HOME/DISPLAY** button to return to the Home Screen.

NOTE

Press the **EXIT/CANCEL** button to cancel a menu operation and return to the menu screen.

3 – Preparation

Making connections

The following illustration shows an example of CG-1800 connections.

Precautions before making connections

- Before making connections, read the operation manuals of the other devices carefully and connect them correctly.
- Turn all devices being connected off (or put them in standby) before making connections.

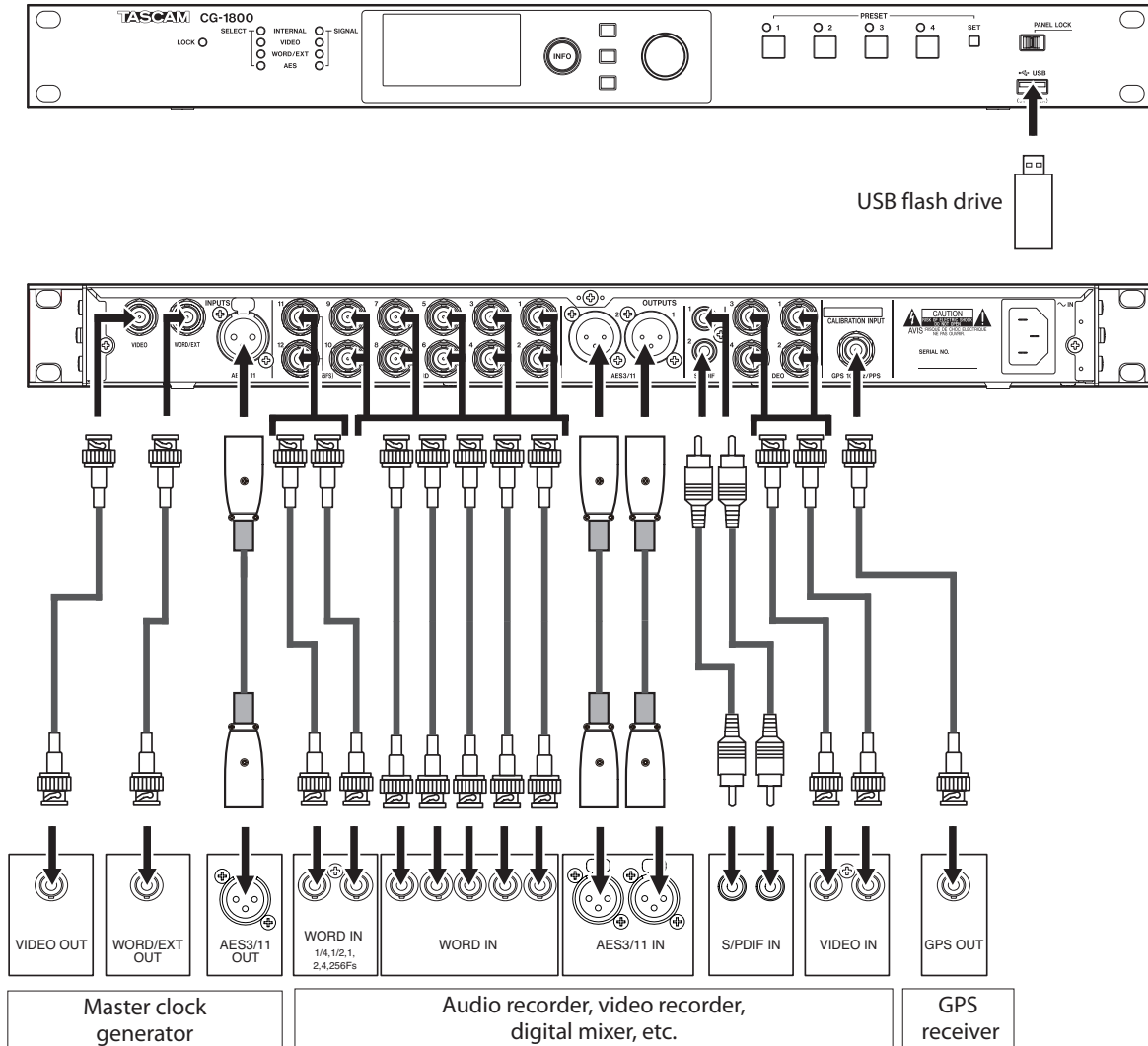

CG-1800 connection example

3 – Preparation

Turning the power on/off

This unit does not have a power switch.

When you connect the power cord to the **AC IN** connector, operation will start.

To turn the power off, disconnect the power cord from the unit. You can also use an external switch, for example, to stop supplying power to the unit

Maximizing the clock generator accuracy

The OCXO (oven-controlled crystal oscillator) has extremely high clock precision and can generate stable clock, but the following precautions should be observed.

One characteristic of OCXOs is that they require a long time to stabilize after power is supplied. This results because of the initial fluctuation that is characteristic of crystal oscillators.

In order to achieve the best performance of an OCXO, we recommend that you do not interrupt its power supply during use.

Moreover, provide the unit with power for a long time so that the internal oscillator is stable before calibrating it. This will increase frequency precision. (See “Calibrating the internal oscillator” on page 24.)

CAUTION

Never remove a USB flash drive when this unit is operating (writing data to the drive, etc.). Doing so could cause data not to be written correctly, cause written data to be lost or otherwise impede the operation of the unit.

Setting the date and time

This unit records the date and time in log entries based on the setting of its internal clock.

1. Press the **MENU** button repeatedly to open the **UTILITY 1** page, and turn the **MULTI JOG** dial to select the **CLOCK ADJUST** item.

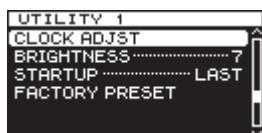

2. Press the **MULTI JOG** dial to open the **CLOCK ADJUST** screen.

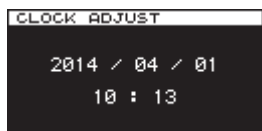

3. Press the **MULTI JOG** dial to enter setting mode and show the cursor on the item to be changed.

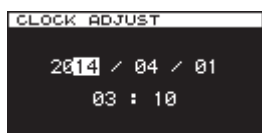

4. Turn the **MULTI JOG** dial to change the value. Then press the **MULTI JOG** dial to confirm it and move the cursor to the next item.
5. After you change the year, month, day, hour and minute in that order, the cursor will disappear, completing the setting of the date and time.

NOTE

Press the **EXIT/CANCEL** button while making a setting to cancel the change and return to the menu screen.

6. Press the **EXIT/CANCEL** button to return to the menu screen.

Adjusting the brightness

With this unit, you can adjust the brightness using a menu item or by using the **HOME/DISPLAY** button and **MULTI JOG** dial.

Adjusting the brightness from the menu

You can only adjust the brightness of the indicators from the menu.

1. Press the **MENU** button repeatedly to open the **UTILITY 1** page, and turn the **MULTI JOG** dial to select the **BRIGHTNESS** item.



2. Press the **MULTI JOG** dial to open the **BRIGHTNESS** screen.

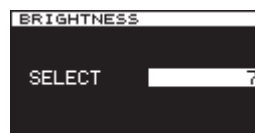

3. Turn the **MULTI JOG** dial to select the brightness value. Options: 7 (default), 6, 5, 4, 3, 2, 1, 0
4. Press the **MULTI JOG** dial to confirm and return to the menu screen.

Adjusting the brightness with the HOME/DISPLAY button and MULTI JOG dial

While pressing and holding the **HOME/DISPLAY** button, turn the **MULTI JOG** dial to adjust the display and indicator brightness.



4 – Basic settings

Setting the reference clock

You can change the selected reference clock.

Set the reference clock on the REFERENCE page.

1. Press the **MENU** button repeatedly to open the REFERENCE menu page, and turn the **MULTI JOG** dial to select the SELECT item.



2. Press the **MULTI JOG** dial to open the REF. SELECT screen.

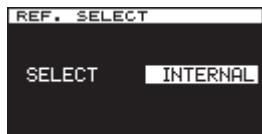

3. Turn the **MULTI JOG** dial to set the reference clock.
Options: INTERNAL (default), VIDEO, WORD, AES
4. Press the **MULTI JOG** dial to confirm the selection and return to the menu.

Setting the video clock (CG-1800 only)

You can change the video clock output format settings.

Set the video clock output format on the VIDEO CLOCK page.

Setting the video format

1. Press the **MENU** button repeatedly to open the VIDEO CLOCK menu page, and turn the **MULTI JOG** dial to select the FORMAT item.

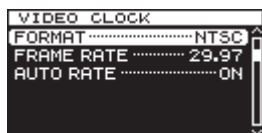

2. Press the **MULTI JOG** dial to open the VIDEO FORMAT screen.

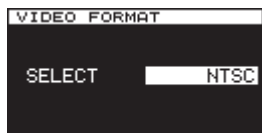

3. Turn the **MULTI JOG** dial to set the video format.
Options: PAL, NTSC (default), 720P, 1080i, 1080PsF, 1080P
4. Press the **MULTI JOG** dial to confirm the selection and return to the menu.

Setting the video frame rate

1. Press the **MENU** button repeatedly to open the VIDEO CLOCK menu page, and turn the **MULTI JOG** dial to select the FRAME RATE item.

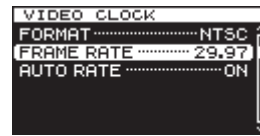

2. Press the **MULTI JOG** dial to open the FRAME RATE screen.

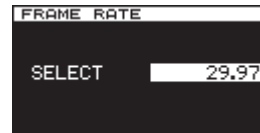

3. Turn the **MULTI JOG** dial to set the video frame rate.
Options: 23.976, 24, 25, 29.97 (default), 30, 50, 59.94, 60

NOTE

The default value above is for when the video format is set to NTSC. The default value will differ according to the video format. In addition, the values that can be selected will differ according to the video format.

4. Press the **MULTI JOG** dial to confirm the selection and return to the menu.

Enabling automatic video frame rate setting

1. Press the **MENU** button repeatedly to open the VIDEO CLOCK menu page, and turn the **MULTI JOG** dial to select the AUTO RATE item.

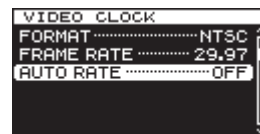

2. Press the **MULTI JOG** dial to open the AUTO RATE screen.



3. Turn the **MULTI JOG** dial to turn the automatic video frame rate setting function on or off.
Options: OFF (default), ON
4. Press the **MULTI JOG** dial to confirm the selection and return to the menu.

Setting the force relock mode (CG-1800 only)

Set the force relock mode used when the phase differs by more than one scan line when switching video reference clocks.

1. Press the **MENU** button to open the REFERENCE menu page, and turn the **MULTI JOG** dial to select the FORCE RELOCK item.



4 – Basic settings

2. Press the **MULTI JOG** dial to open the **FORCE RELOCK** screen.

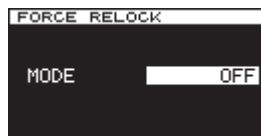

3. Turn the **MULTI JOG** dial to set the force relock mode of the reference redundancy function.
Options: OFF (default), AUTO
4. Press the **MULTI JOG** dial to confirm the selection and return to the menu.

Setting the audio clock

You can change audio clock output format settings.

Change the audio clock output format settings on the **AUDIO CLOCK** page.

Setting the audio clock frequency

1. Press the **MENU** button repeatedly to open the **AUDIO CLOCK** menu page, and turn the **MULTI JOG** dial to select the **SAMPLE** item.

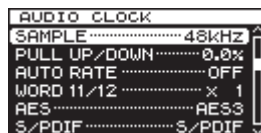

2. Press the **MULTI JOG** dial to open the **SAMPLING RATE** screen.

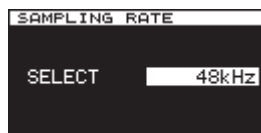

3. Turn the **MULTI JOG** dial to set the audio clock frequency.
Options: 32kHz, 44.1kHz, 48kHz (default), 88.2kHz, 96kHz, 176.4kHz, 192kHz
4. Press the **MULTI JOG** dial to confirm the selection and return to the menu.

NOTE

- If the reference clock is audio clock and it does not match the set audio clock frequency, the clock will be unlocked.
- If 48kHz, 96kHz or 192kHz is selected above, pull-up/pull-down settings will be enabled.

Setting audio clock frequency pull-up/pull-down (CG-1800 only)

You can set audio clock frequency pull-up or pull-down if needed.

1. Press the **MENU** button repeatedly to open the **AUDIO CLOCK** menu page, and turn the **MULTI JOG** dial to select the **PULL UP/DOWN** item.

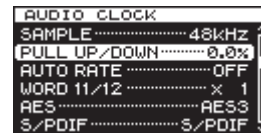

2. Press the **MULTI JOG** dial to open the **PULL UP/DOWN** screen.



3. Turn the **MULTI JOG** dial to set the audio clock frequency pull-up or pull-down value.
Options: -4%, -0.1%, 0.0% (default), +0.1%, +4%
4. Press the **MULTI JOG** dial to confirm the selection and return to the menu.

NOTE

The pull-up or pull-down setting is only enabled when the audio clock frequency is set to 48kHz, 96kHz or 192kHz.

Enabling automatic audio clock frequency setting

You can set whether or not the audio clock frequency is set automatically to match a reference clock signal received through the **WORD/EXT** input connector (not including 10MHz) or **AES3/11** input connector.

1. Press the **MENU** button repeatedly to open the **AUDIO CLOCK** menu page, and turn the **MULTI JOG** dial to select the **AUTO RATE** item.

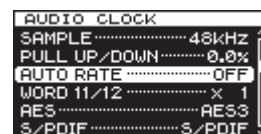

2. Press the **MULTI JOG** dial to open the **AUTO RATE** screen.



3. Turn the **MULTI JOG** dial to turn automatic audio clock frequency setting on or off.
Options: OFF (default), ON
4. Press the **MULTI JOG** dial to confirm the selection and return to the menu.

Setting the audio clock frequency multiplier for the WORD 11/12 OUTPUTS

You can set a multiplier for the audio clock frequency output from the **WORD 11/12 OUTPUTS**.

1. Press the **MENU** button repeatedly to open the **AUDIO CLOCK** menu page, and turn the **MULTI JOG** dial to select the **WORD 11/12** item.

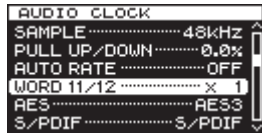

2. Press the **MULTI JOG** dial to open the **WORD OUT 11/12** screen.

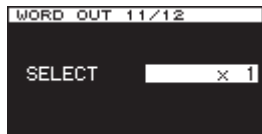

3. Turn the **MULTI JOG** dial to set the multiplier for the audio clock frequency output from the **WORD 11/12 OUTPUTS**.
Options: x1/4, x1/2, x1 (default), x2, x4, x256 (Super Clock)

The audio clock frequency output will be as follows according to the setting.

		Setting					
		x1/4	x1/2	x1	x2	x4	x256 (Super Clock)
Original audio clock frequency (kHz)	32	32	32	32	64	128	32
	44.1	44.1	44.1	44.1	88.2	176.4	11289.6
	88.2	44.1	44.1	88.2	176.4	176.4	11289.6
	176.4	44.1	88.2	176.4	176.4	176.4	11289.6
	48	48	48	48	96	192	12288
	96	48	48	96	192	192	12288
	192	48	96	192	192	192	12288

NOTE

If pull-up/pull-down has been set, the pull-up/pull-down will be applied to the output audio clock frequency.

Setting the output format for AES 3/11 and S/PDIF output connectors

You can set the output format used by the **AES3/11 1/2** (balanced XLR) and **S/PDIF 1/2 OUTPUTS**.

Set the output format on the **AUDIO CLOCK** page.

NOTE

The audio data of the AES3 and S/PDIF output signals will be output as "ALL 0".

Setting the output format for AES 3/11 outputs

1. Press the **MENU** button repeatedly to open the **AUDIO CLOCK** menu page, and turn the **MULTI JOG** dial to select the **AES** item.

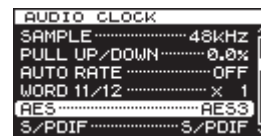

2. Press the **MULTI JOG** dial to open the **AES FORMAT** screen.

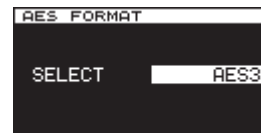

3. Turn the **MULTI JOG** dial to set the output format for the **AES 3/11 1/2 OUTPUTS** (balanced XLR).
Options: AES3 (default), AES11, S/PDIF
4. Press the **MULTI JOG** dial to confirm the selection and return to the menu.

Setting the output format for S/PDIF outputs

1. Press the **MENU** button repeatedly to open the **AUDIO CLOCK** menu page, and turn the **MULTI JOG** dial to select the **S/PDIF** item.

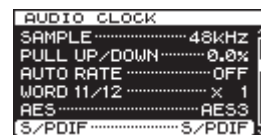

2. Press the **MULTI JOG** dial to open the **S/PDIF FORMAT** screen.

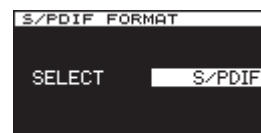

3. Turn the **MULTI JOG** dial to set the output format for the **S/PDIF 1/2 OUTPUTS** (RCA pin jacks).
Options: AES3, S/PDIF (default)
4. Press the **MULTI JOG** dial to confirm the selection and return to the menu.

5 – Preset function

You can save the current settings of this unit as a preset, and you can instantly recall saved presets.

See “Default setting values list” on page 25 for the settings of the presets (1–4) when the unit is shipped new from the factory.

Saving the current settings as a preset

The **PRESET 1 – 4** buttons can be used to save presets.

Saving procedure

Follow these procedures to save a preset to this unit's **PRESET 1 – PRESET 4** button.

1. Press the **SET** button.
2. When all the **PRESET** indicators (1–4) are blinking, press the **PRESET** button to which you want to save the current settings.

A **STORE PRESET** pop-up will appear.



3. Press the **MULTI JOG** dial to save the unit's current settings to the **PRESET** that you pressed in step 2.

CAUTION

Be aware that the settings previously stored with that preset button will be overwritten.

Recalling presets

The settings saved to the **PRESET 1 – 4** buttons can be recalled for use as the current settings of the unit.

Recall procedure

1. Press the **PRESET** button with the settings that you want to recall. A **CALL PRESET** pop-up will appear.

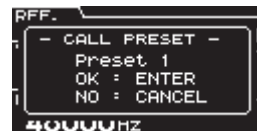

2. Press the **MULTI JOG** dial to use the settings of the selected preset as the unit settings.

CAUTION

Be aware that the settings used by the unit before recall will be overwritten by the preset settings and that this operation cannot be reversed.

TIP

You can also save preset settings to a USB flash drive and load these settings from the drive. (See “6 – Operations using USB flash drives” on page 19.)

Restoring presets to their factory defaults

The presets can be restored to their factory defaults by restoring all the settings in the unit to their factory default settings. (See “Restoring factory default settings” on page 23.)

6 – Operations using USB flash drives

Overview

You can use the following functions by connecting a USB flash drive to this unit's **USB** port.

- Write the unit's preset settings data
- Save the unit's operation log
- Load backed up setting data from the USB flash drive
- Update the unit's system firmware

Connecting/disconnecting USB flash drives

Connecting a USB flash drive

Insert a USB flash drive into this unit's **USB** port.

NOTE

You can insert a USB flash drive when the unit is on or off.

Disconnecting a USB flash drive

After reading/writing completes, disconnect the USB flash drive.

CAUTION

Never turn the power off when, for example data is being written to or read from a USB flash drive. Doing so could cause data not to be written or read correctly, cause written or loaded data to be lost or otherwise impede the operation of the unit.

Exporting presets to USB flash drives

You can export presets that have been saved in this unit to USB flash drives.

This can be done from the **UTILITY 2** page.

1. Press the **MENU** button repeatedly to open the **UTILITY 2** menu page, and turn the **MULTI JOG** dial to select the **PRESET IMP/EXPORT** item.

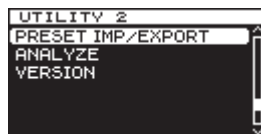

2. Press the **MULTI JOG** dial to open the **IMP/EXPORT** screen.

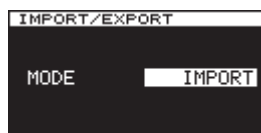

3. Turn the **MULTI JOG** dial to set the **MODE** item to **EXPORT**.



4. Press the **MULTI JOG** dial to show the **EXPORT FROM** item on the **IMP/EXPORT** screen.



5. Turn the **MULTI JOG** dial to select the preset number that you want to export.

Select **SYS ALL** to export all the current menu settings and presets 1–4 as a single settings file.

Options: **PRESET 1**, **PRESET 2**, **PRESET 3**, **PRESET 4**, **SYS ALL**

6. Press the **MULTI JOG** dial to open a pop-up message where you can confirm the name of the preset to export.



When a single preset number is selected



When **SYS ALL** is selected

7. Press the **MULTI JOG** dial to start exporting from this unit to the USB flash drive.



NOTE

*Before pressing the **MULTI JOG** dial, press the **EXIT/CANCEL** button to cancel exporting and return to the menu screen.*

8. After exporting completes or is canceled, the unit will return to the state shown in step 4.

Repeat steps 5 - 7 if you want to export additional preset data.

NOTE

The file name with the exported data includes the date and an id number that is assigned consecutively. Even if the USB flash drive contains a file with data for the same preset number, it will not be overwritten when the new file is saved.

6 – Operations using USB flash drives

Importing presets from USB flash drives

Preset data exported to a USB flash drive can be imported to this unit's preset memory.

This can be done from the UTILITY 2 page.

1. Press the **MENU** button repeatedly to open the UTILITY 2 menu page, and turn the **MULTI JOG** dial to select the PRESET IMP/EXPORT item.



2. Press the **MULTI JOG** dial to open the IMP/EXPORT screen.



3. Turn the **MULTI JOG** dial to set the MODE to IMPORT.

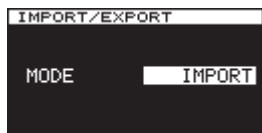

4. Press the **MULTI JOG** dial to open the IMPORT FROM screen.
The preset and SYS ALL data saved on the USB flash drive will appear in a list.

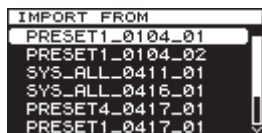

5. Turn the **MULTI JOG** dial to select the preset that you want to import.

NOTE

Presets with the same numbers can be distinguished by their dates and id numbers.

6. Press the **MULTI JOG** dial.

If you selected data for a preset on the USB flash drive, the IMPORT TO screen will open.

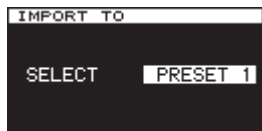

If you selected SYS ALL data, the import confirmation screen shown in step 8 will appear (skip step 7).

7. If you selected data for a preset on the USB flash drive, turn The **MULTI JOG** dial to select the preset number to which you want to import that data.
Options: PRESET 1, PRESET 2, PRESET 3, PRESET 4
8. Press the **MULTI JOG** dial to open the import confirmation screen.



When data for a single preset is selected

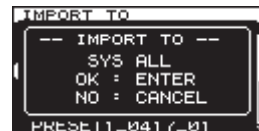

When SYS ALL is selected

9. Press the **MULTI JOG** dial to start importing from the USB flash drive to this unit.



NOTE

Before pressing the MULTI JOG dial, press the EXIT/CANCEL button to cancel importing and return to the menu screen.

10. After importing completes or is canceled, the unit will return to the state shown in step 4.

Repeat steps 5 - 7 if you want to import additional preset data.

CAUTION

After importing completes, preset data previously stored will be overwritten. This procedure cannot be reversed.

Exporting the operation log

This unit saves an operation log (record).

You cannot check this operation log on this unit, but you can export it to a USB flash drive.

The exported file will have be in “.csv” format, so you can check it on a computer.

Export the log using the LOG page.

This operation exports the data saved in the operation log of this unit.

1. Press the **MENU** button repeatedly to open the LOG menu page, and turn the **MULTI JOG** dial to select the LOG EXPORT item.



2. Press the **MULTI JOG** dial to open the LOG EXPORT pop-up message.



3. Press the **MULTI JOG** dial again to export the log.
Press the **EXIT/CANCEL** button to cancel exporting
4. After exporting or canceling, the LOG screen reopens.

7 – Analyze function

This unit includes an analyze function for use in the unlikely event that trouble should occur. This function allows you to identify the general trouble and resolve it easily without using measurement equipment.

Using the analyze function

Follow these procedures to use the analyze function.

The analyze function can be used from the **UTILITY 2** page.

1. Press the **MENU** button repeatedly to open the **UTILITY 2** menu page, and turn the **MULTI JOG** dial to select the **ANALYZE** item.

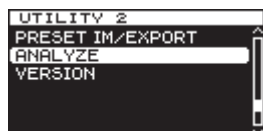

2. Press the **MULTI JOG** dial to open the **ANALYZE** screen, which shows the results of analysis.

INPUT FREQUENCY

This shows the reference input frequency.

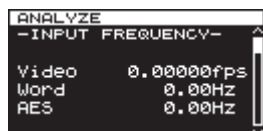

Analysis results: fps for video and Hz for other items

INPUT LEVEL (CG-1800 only)

This shows the signal level of the reference input.

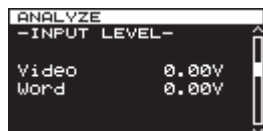

Analysis results: V

TERMINATION (CG-1800 only)

This shows the state of the termination resistance of the device at output.

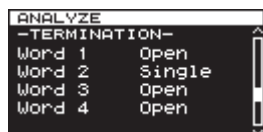

Analysis results:

OPEN: There is no termination.

SINGLE: There is a termination at one location. This is normal.

OVER: There are termination at two or more locations.

8 – Other functions

Setting the termination for reference input connectors

Set the termination for each input connector according to the wiring.

Make these settings on the **TERMINATION** page.

1. Press the **MENU** button repeatedly to open the **TERMINATION** menu page, and turn the **MULTI JOG** dial to select the input connector for which you want to set the termination.

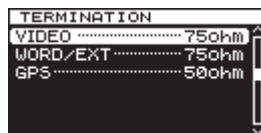

VIDEO selected

2. Press the **MULTI JOG** dial to open the **TERMINATION XXX** screen ("XXX" is the name of the input connector).

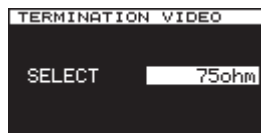

TERMINATION VIDEO screen open

3. Turn the **MULTI JOG** dial to set the termination for the input connector.

Options

Video clock input connector: 75ohm (default), OPEN

Word clock input connector: 75ohm (default), 50ohm, OPEN

GPS signal input connector: 50ohm (default), OPEN

4. Press the **MULTI JOG** dial to confirm the selection and return to the menu.

Setting the levels of the word clock outputs

You can change the output levels of the word clock outputs.

Change these levels on the **WORD OUT LEVEL** page.

1. Press the **MENU** button repeatedly to open the **WORD OUT LEVEL** menu page, and turn the **MULTI JOG** dial to select the word clock output connectors for which you want to set the level.



1/2 selected

2. Press the **MULTI JOG** dial to open the **WORD OUT LEVEL 1/2** screen.

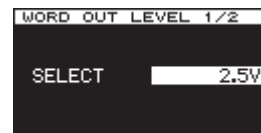

WORD OUT LEVEL 1/2 screen open

3. Turn the **MULTI JOG** dial to set the output level of the word clock output connectors.
Options: 1.0V, 1.5V, 2.0V, 2.5V (default), 3.0V, 3.5V
4. Press the **MULTI JOG** dial to confirm the selection and return to the menu.

Restoring factory default settings

You can restore the various settings saved in this unit's backup memory to their factory defaults.

Do this from the **UTILITY 1** page.

See "Default setting values list" on page 25 for the settings when the unit is shipped new from the factory.

NOTE

*The **STARTUP** item setting cannot be restored to the factory default.*

1. Press the **MENU** button repeatedly to open the **UTILITY 1** menu page, and turn the **MULTI JOG** dial to select the **FACTORY PRESET** item.

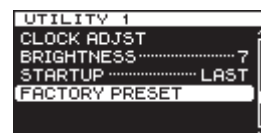

2. Press the **MULTI JOG** dial to open the **FACTORY PRESET** pop-up.



3. Press the **MULTI JOG** dial to execute, or press the **EXIT/CANCEL** button to cancel.

8 – Other functions

Setting the startup preset

You can set the preset used at startup when this unit is turned on. Make this setting on the UTILITY 1 page.

1. Press the **MENU** button to open the UTILITY 1 menu page, and turn the **MULTI JOG** dial to select the STARTUP item.



2. Press the **MULTI JOG** dial to open the STARTUP MODE screen.

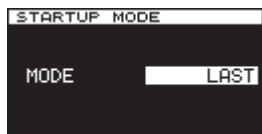

3. Turn the **MULTI JOG** dial to set the preset used at startup.

Option	Function
LAST (default)	Startup with last used settings
PRESET 1	Startup with the corresponding preset settings
PRESET 2	
PRESET 3	
PRESET 4	
FACTORY	Startup with factory default settings

NOTE

The STARTUP item setting cannot be restored to the factory default.

4. Press the **MULTI JOG** dial to confirm the selection and return to the menu.

Calibrating the internal oscillator

The importance of calibration

This unit has an OCXO (oven-controlled crystal oscillator) that provides 0.01ppm high-precision frequency output. However, every clock generator, including this one, can normally be expected to change over time.

In order to enable continued use with high-performance, this unit has a function for calibrating the internal oscillator.

If you connect and input a 10MHz signal generated from a GPS signal or a PPS signal, for example, to the dedicated CALIBRATION INPUT connector, the unit will recognize it automatically and calibrate the internal clock.

Checking the unit firmware version

Follow these procedures to check this unit's firmware version.

Do this before updating the firmware, for example.

1. Press the **MENU** button repeatedly to open the UTILITY 2 menu page, and turn the **MULTI JOG** dial to select the VERSION item.



2. Press the **MULTI JOG** dial to open the VERSION screen. The VERSION screen shows information about the firmware version and build number.
3. Press the **EXIT/CANCEL** button to return to the menu screen.

NOTE

When the VERSION screen is open during step 2 above, press the **MULTI JOG** dial to switch to firmware updating. For the latest information about updating firmware, visit the TEAC Global Site (<http://teac-global.com/>).

Checking the error log

Follow these procedures to check the error log, which contains information about past errors.

Check the error log from the LOG page.

1. Press the **MENU** button repeatedly to open the LOG page menu, and turn the **MULTI JOG** dial to select the ERROR LOG item.

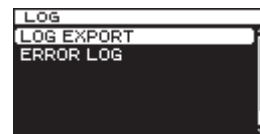

2. Press the **MULTI JOG** dial to open the ERROR LOG screen. In the error log, each error is shown on a separate page.

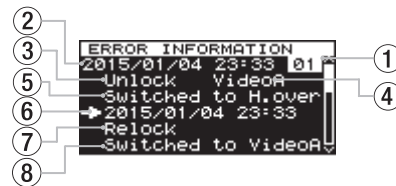

Error log page example

- ① **Error log number**
These numbers are assigned to errors in order as they are added to the log.
- ② **Error date and time**
This shows when the error was added to the log.
- ③ **Error summary**
This shows the error code and signal affected as described in the Overview of error codes table. (See "Overview of error codes" on page 10.)
- ④ **Signal that error affected**
This shows the signal that the error affected.
- ⑤ **Error result**
This shows what happened because of the error.
- ⑥ **Recovery date and time**
This shows when the unit recovered from the error.
- ⑦ **Recovery summary**
This shows how the unit recovered from the error.
- ⑧ **Recovery result**
This shows what happened when the unit recovered.

Default setting values list

The factory menu defaults and preset values are as follows.

Menu page	Menu item	Default	Preset
REFERENCE	SELECT	INTERNAL	✓
	FORCE RELOCK (CG-1800 only)	OFF	✓
VIDEO CLOCK (CG-1800 only)	FORMAT	NTSC	✓
	FRAME RATE	29.97 (*1)	✓
	AUTO RATE	OFF	✓
AUDIO CLOCK	SAMPLE	48kHz	✓
	PULL UP/DOWN (CG-1800 only)	0.0%	✓
	AUTO RATE	OFF	✓
	WORD 11/12	x1	✓
	AES	AES3	✓
	S/PDIF	S/PDIF	✓
TERMINATION	VIDEO (CG-1800 only)	75ohm	✓
	WORD	75ohm	✓
	GPS	50ohm	✓
WORD OUT LEVEL	1/2	2.5V	✓
	3/4	2.5V	✓
	5/6	2.5V	✓
	7/8	2.5V	✓
	9/10	2.5V	✓
	11/12	2.5V	✓
UTILITY 1	BRIGHTNESS	7	✓
	STARTUP	LAST(*2)	–

✓ : Saved in preset

– : Not saved in preset

*1: The default and preset values of the FRAME RATE item are different for each video format. (CG-1800 only)

Video format	Video frame rate
NTSC	29.97
PAL	25
1080i / 1080Psf	29.97
1080P / 720P	59.94

*2: This will not be restored to the factory default even if the FACTORY PRESET item is executed.

9 – Specifications

Inputs and outputs

VIDEO INPUTS (CG-1800 only)

Connector type:	BNC
Input level:	0.5–2.0 Vp-p
Input impedance:	75 Ω (can turn ON/OFF in menu)
Input format	
SD video black burst:	
NTSC (RS-170A)	
PAL (ITU-R624)	
SD video composite sync:	
NTSC B/W (RS-170)	
HD video tri-level:	
720p/50/59.94/60 (SMPTE 296M)	
1080p/23.976/24/25/29.97/30/50/59.94/60 (SMPTE 274M)	
1080i/23.976/24/25/29.97/30 (SMPTE 274M)	
1080PsF/23.976/24/25/29.97/30 (SMPTE RP211)	
Permissible frequency deviation:	±10 ppm

WORD/EXT INPUTS

Connector type:	BNC
Input level:	0.5–5.0 Vp-p
Input impedance:	75/50 Ω (can set to 75/50/OFF in menu)
Supported frequencies	
WORD CLOCK:	32/44.1/48/88.2/96/176.4/192 kHz (–4/–0.1/0.0/+0.1/+4% PULL UP/DOWN supported only when 48/96/192 kHz selected)
ATOM:	10.0 MHz
GPS:	10.0 MHz
Permissible frequency deviation:	±10 ppm

AES3/11 INPUT

Connector type:	XLR-3-31 (1: GND, 2: HOT, 3: COLD)
Input level:	0.2–10 Vp-p
Input impedance:	110 Ω
Format:	AES11-2003, AES3-2003, IEC60958-4
Supported frequencies:	32/44.1/48/88.2/96/176.4/192 kHz (–4/–0.1/0.0/+0.1/+4% PULL UP/DOWN supported only when 48/96/192 kHz selected)
Permissible frequency deviation:	±10 ppm

CALIBRATION INPUT

Connector type:	BNC
Input level:	0.5–5.0 Vp-p
Input impedance:	50 Ω (can turn ON/OFF in menu)
Supported frequencies	
ATOM:	10.0 MHz
GPS:	10.0 MHz, PPS

VIDEO OUTPUTS (CG-1800 only)

Connector type:	BNC
Output impedance:	75 Ω
Output format	
SD video black burst:	
NTSC (RS-170A)	
PAL (ITU-R624)	
SD video composite sync:	
NTSC B/W (RS-170)	

HD video tri-level:	
720p/50/59.94/60 (SMPTE 296M)	
1080p/23.976/24/25/29.97/30/50/59.94/60 (SMPTE 274M)	
1080i/23.976/24/25/29.97/30 (SMPTE 274M)	
1080PsF/23.976/24/25/29.97/30 (SMPTE RP211)	

WORD OUTPUTS

Connector type:	BNC connector
Output level:	1.0–3.5Vp-p (can set by 0.5V steps in menu)
Output impedance:	75 Ω
Supported frequencies:	32/44.1/48/88.2/96/176.4/192 kHz 11.2896/12.288 MHz (Super Clock, only connectors 11/12) (–4/–0.1/0.0/+0.1/+4% PULL UP/DOWN supported only when 48/96/192 kHz selected)

AES3/11 OUTPUTS

Connector type:	XLR-3-32 (1: GND, 2: HOT, 3: COLD)
Output level:	2.5 Vp-p
Output impedance:	110 Ω
Format:	AES11-2003, AES3-2003, IEC60958-4
Supported frequencies:	32/44.1/48/88.2/96/176.4/192 kHz

S/PDIF OUTPUTS

Connector type:	RCA pin jack
Output level:	0.5 Vp-p
Output impedance:	75 Ω
Format:	IEC60958-3 (S/PDIF)
Supported frequencies:	32/44.1/48/88.2/96/176.4/192 kHz (–4/–0.1/0.0/+0.1/+4% PULL UP/DOWN supported only when 48/96/192 kHz selected)

Performance

Internal oscillator

Type:	OVCXO (oven-controlled crystal oscillator)
Permitted frequency deviation:	±0.01 ppm (Adjusted value when shipped new from the factory)
Frequency temperature characteristics:	±0.05 ppm (0 to 40 °C)
Long-term frequency stability:	±0.005 ppm (daily) ±0.5 ppm (annually)

General

Power

AC100 V–240 V, 50/60Hz

Power consumption

CG-1800: 11.5 W
CG-1000: 10 W

External dimensions

483 x 45 x 310mm (width x height x depth)

Weight

CG-1800: 3.2 kg (7.1 lb)
CG-1000: 3.1 kg (6.8 lb)

Operating temperature range

0–40°C (32–104°F)

Dimensional drawings

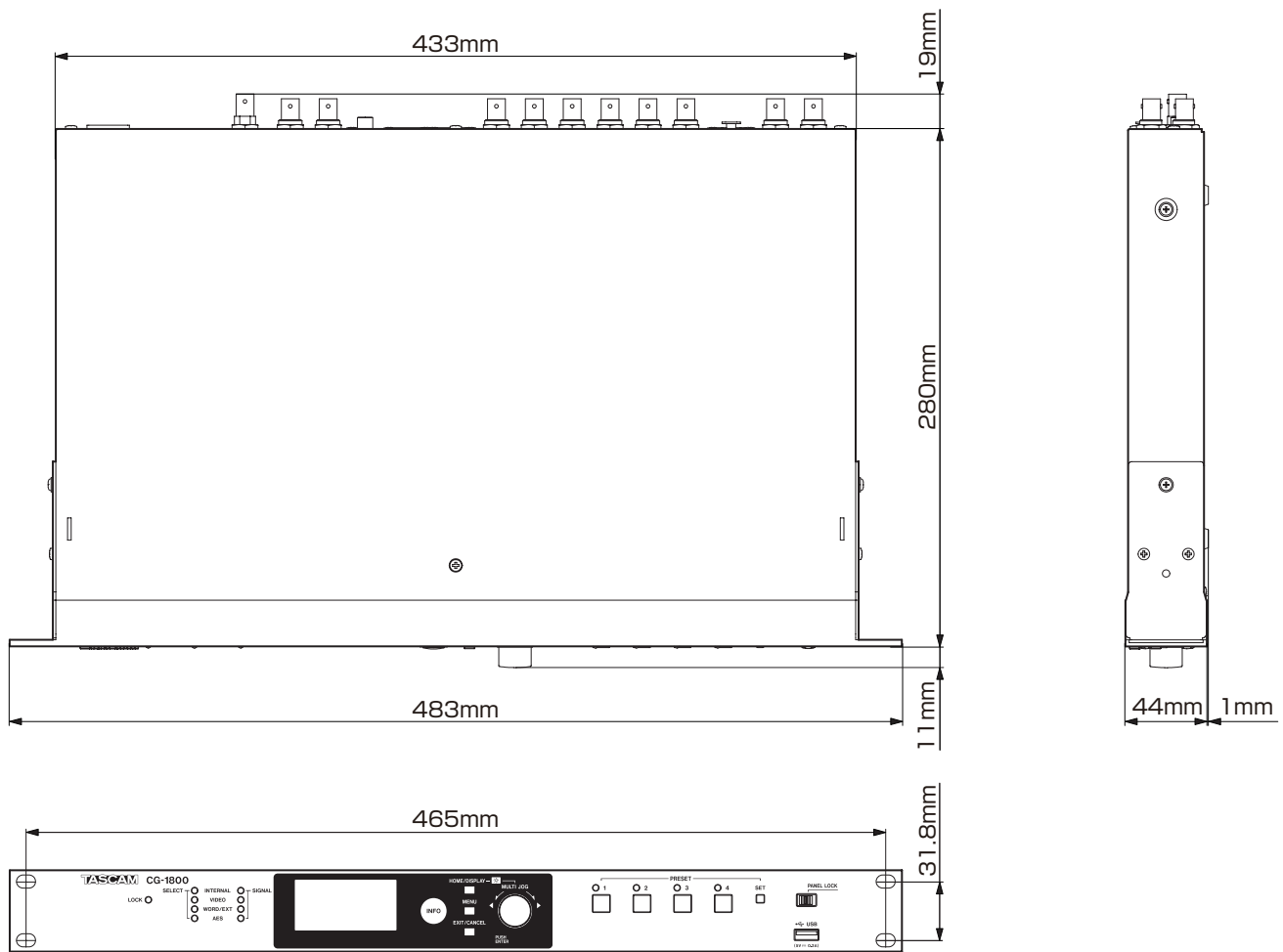

- Illustrations in this Owner's Manual might differ in part from the actual product.
- Specifications and external appearance could be changed without notification to improve the product.

WARRANTY

< In the United States >

This warranty gives you specific legal rights and you may also have other rights which vary from state to state. This warranty is only valid within the country the unit was originally purchased.

WHAT IS AND IS NOT COVERED

Except as specified below, this warranty covers all defects in materials and workmanship in this product. The following are not covered by the warranty:

1. Damage to or deterioration of the external cabinet.
2. Damages resulting from accident, misuse, abuse or neglect.
3. Damage resulting from failure to perform basic daily maintenance and/or calibration or otherwise resulting from failure to follow instructions contained in your owner's manual.
4. Damage occurring during shipment of the product. (Claims must be presented to the carrier)
5. Damage resulting from repair or attempted repair by anyone other than TEAC or an authorized TASCAM service station.
6. Damage resulting from causes other than product defects, including lack of technical skill, competence, or experience of the user.
7. Damage to any unit which has been altered or on which the serial number has been defaced, modified or is missing.

WHO MAY ENFORCE THE WARRANTY

This warranty may be enforced only by the original purchaser.

LENGTH OF WARRANTY

All parts except heads and disk drives are warranted for one (1) year from the date of original purchase. Heads and disk drives are warranted to ninety (90) days from date of original purchase. Labor is warranted for ninety (90) days from date of original purchase.

WHAT WE WILL PAY FOR

We will pay all labor and material expenses for items covered by the warranty. Payment of shipping charges is discussed in the next section of this warranty.

HOW YOU CAN GET WARRANTY SERVICE

Your unit must be serviced by an authorized TASCAM service station in the United States. (This warranty is not enforceable outside the U.S.) If you are unable to locate an authorized TASCAM service station in your area, please contact us. We either will refer you to an authorized service station or instruct you to return the unit to the factory. Whenever warranty service is required, you must present a copy of the original dated sales receipt from an Authorized TASCAM Dealer.

You must pay any shipping charges if it is necessary to ship the product to service. However, if the necessary repairs are covered by the warranty, we will pay return surface shipping charges to any destination within the United States.

LIMITATION OF IMPLIED WARRANTIES

Any implied warranties, INCLUDING WARRANTIES OF MERCHANTABILITY AND FITNESS FOR A PARTICULAR PURPOSE, are limited in duration to the length of this warranty.

EXCLUSION OF DAMAGES

TEAC's liability for any defective product is limited to repair or replacement of the product, at TEAC's option. TEAC shall not be liable for:

1. Damages based upon inconvenience, loss of use of the product, loss of time interrupted operation or commercial loss; or
2. Any other damages, whether incidental, consequential or otherwise.

Some states do not allow limitations on how long an implied warranty lasts and/or do not allow the exclusion or limitation of incidental or consequential damages, so the above limitations and exclusions may not apply to you.

To locate an Authorized Service Center in Your Area

CALL 1-800-447-8322

< Europe >

This product is subject to the legal warranty regulations of the country of purchase. In case of a defect or a problem, please contact the dealer where you bought the product.

Ce produit est sujet aux réglementations concernant la garantie légale dans le pays d'achat. En cas de défaut ou de problème, veuillez contacter le revendeur chez qui vous avez acheté le produit.

Dieses Gerät unterliegt den gesetzlichen Gewährleistungsbestimmungen des Landes, in dem es erworben wurde. Bitte wenden Sie sich im Gewährleistungsfall an den Händler, bei dem sie das Gerät erworben haben.

Questo apparecchio è conforme alle norme sulla garanzia vigenti nel rispettivo Paese in cui esso è stato acquistato. Si prega di rivolgersi al proprio commerciante, presso il quale è stato acquistato l'apparecchio, nel caso in cui si voglia richiedere una prestazione in garanzia.

Las condiciones de garantía de este aparato están sujetas a las disposiciones legales sobre garantía del país en el que ha sido adquirido. En caso de garantía, debe dirigirse al establecimiento donde adquirió el aparato.

< In other countries/areas >

This warranty gives you specific legal rights, and you may also have other rights that vary by country, state or province.

If you have a warranty claim or request, please contact the dealer where you bought the product.

该保证书赋予了顾客特定的合法权利，并且因国家，州或省等地域的不同，顾客可能拥有其他权利。如需申请或要求保修，请与购买本产品的销售店进行联系。

If you require repair services for your TASCAM equipment, please contact the dealer where the product was purchased from or the TASCAM Distributor in your country. A list of TASCAM Distributors can be found on our website at: <http://teac-global.com/>

TASCAM

TEAC CORPORATION

Phone: +81-42-356-9143

1-47 Ochiai, Tama-shi, Tokyo 206-8530 Japan

<http://tascam.jp/>

TEAC AMERICA, INC.

Phone: +1-323-726-0303

1834 Gage Road, Montebello, California 90640 USA

<http://tascam.com/>

TEAC MEXICO, S.A. de C.V.

Phone: +52-55-5010-6000

Río Churubusco 364, Colonia Del Carmen, Delegación Coyoacán, CP 04100, México DF, México

<http://teacmexico.net/>

TEAC UK LIMITED

Phone: +44-8451-302511

Meridien House, Ground Floor, 69 - 71, Clarendon Road, Watford, Hertfordshire, WD17 1DS, UK

<http://tascam.eu/>

TEAC EUROPE GmbH

Phone: +49-611-71580

Bahnstrasse 12, 65205 Wiesbaden-Erbenheim, Germany

<http://tascam.eu/>

TEAC SALES & TRADING(SHENZHEN) CO., LTD

Phone: +86-755-88311561~2

Room 817, Block A, Hailrun Complex, 6021 Shennan Blvd., Futian District, Shenzhen 518040, China

<http://tascam.cn/>

Printed in China

WARRANTY

Model/Modèle/Modell
Modello/Modello/型号

CC-1000 / CC-1000

Serial No./No de Série/Seriennummer
Numero di serie/Número de serie/序列号

Owner's name/Nom du possesseur/Name des Eigentümers
Nome del proprietario/Nombre del propietario/顾客姓名

Address/Adresse/Adresse
Indirizzo/Dirección/顾客地址

Date of purchase/Date de l'achat/Datum des Kaufs
Data dell'acquisto/Fecha de compra/购买日期

Dealer's name/Nom du détaillant/Name des Händlers
Nome del commerciante/Nombre del establecimiento/销售店名

TASCAM
<http://teac-global.com/>

Dealer's address/Adresse du détaillant/Adresse des Händlers
Indirizzo del commerciante/Dirección del establecimiento/销售店地址

Free Manuals Download Website

<http://myh66.com>

<http://usermanuals.us>

<http://www.somanuals.com>

<http://www.4manuals.cc>

<http://www.manual-lib.com>

<http://www.404manual.com>

<http://www.luxmanual.com>

<http://aubethermostatmanual.com>

Golf course search by state

<http://golfingnear.com>

Email search by domain

<http://emailbydomain.com>

Auto manuals search

<http://auto.somanuals.com>

TV manuals search

<http://tv.somanuals.com>