

2U Rackmount DVD/CD Duplicator User's Manual

Models:

TASCAM DV-W11R

TASCAM[®]

Safety Precautions

Rackmount DVD/CD Duplicators are high-precision electronic devices. Do not use them in any manner other than as specified in this manual. Please read this manual in its entirety before you begin the installation procedure. Use of controls, adjustments, or performance of procedures other than those specified herein may result in hazardous laser exposure.

To prevent fire or shock, do not expose the unit to moisture or rain.

To prevent electrical shock, do not attempt to disassemble the DVD/CD Duplicator. Refer servicing to authorized personnel.

Rackmount DVD/CD Duplicator drives utilize a laser beam that can be harmful to your eyes. Do not disassemble the cabinet or unit. Do not attempt to look through the front panel or into the unit while the power is turned on.

Elevated Operating Ambient: If the unit is installed in a closed or multi-unit rack assembly, the operating ambient temperature of the rack environment may be greater than the room ambient temperature. Therefore, consideration should be given to installing the equipment in an environment compatible with the maximum ambient temperature (T_{ma}) specified by the manufacturer.

Reduced Air Flow: Installation of the equipment in a rack should be such that the amount of air flow required for safe operation of the equipment is not compromised.

Mechanical Loading: Mounting of the equipment in the rack should be such that a hazardous condition is not achieved due to uneven mechanical loading.

Circuit Overloading: Consideration should be given to the connection of the equipment to the supply circuit and the effect that overloading of the circuits might have on over-current protection and supply wiring. Appropriate consideration of equipment nameplate ratings should be used when addressing this concern.

Reliable Earthing: Reliable earthing of rack-mounted equipment should be maintained. Particular attention should be given to supply connections other than direct connections to the branch circuit (e.g. use of power strips).

A user who changes or modifies the unit or operating procedures specified herein without expressed written approval from the manufacturer will void user authority to operate the equipment.

Specifications and features subject to change without notice or obligation.

Copyright and Trademark Information

© Copyright 2009 TEAC America, Inc. All rights reserved.

TEAC America, Inc. reserves the right to modify product offerings or specifications without advanced notice. No part of this publication may be reproduced in any format without the expressed written permission of TEAC America, Inc.

TEAC and TASCAM are trademarks of TEAC Corporation. All other trademarks and registered trademarks are the property of their respective owners.

Piracy Statement

Copying or duplicating copyrighted materials—including audio compact discs (CDs) and DVD movies—without the permission of the copyright holder constitutes theft of intellectual property. It is a serious crime and a violation of Federal law.

Do not use the TEAC or TASCAM Rackmount DVD/CD Duplicator (or any equipment) to copy or duplicate copyrighted digital audio, video, photographs, images, text, software or other digital information without the permission of the copyright holder.

TEAC and TASCAM accept no responsibility for copyright infringement or misuse of this equipment. It is the sole responsibility of the user to use the equipment within the limits prescribed by law and to respect the legal copyrights of all copyright owners.

FCC Radio Frequency Interference Regulations

Warning: This equipment generates, uses, and can radiate radio frequency energy and if not installed and used in accordance with the instructions contained in this manual, may cause harmful interference to radio and television communications. This equipment has been tested and found to comply with the limits for a Class B digital device pursuant to Subpart B of Part 15 of the FCC Rules. These limits are designed to provide reasonable protection against harmful interference in a residential installation. However, there is no guarantee that interference will not occur in a particular installation.

If this equipment does cause harmful interference to radio or television reception (which can be determined by turning the equipment off and on), the user may try to correct the interference by one or more of the following measures:

- Reorient or relocate the receiving antenna.
- Move the device and the receiver further apart.
- Connect the equipment to an electrical outlet on a different circuit than the receiver.
- Consult the dealer or an experienced audio television technician.

Also, the following booklet may prove helpful: *How to Identify and Resolve Radio-TV Interference Problems*. It is available from the U.S. Government Printing Office, Washington, D.C. 20402, stock number 004-000-00345-4.

The user is cautioned that any changes or modifications not expressly approved by TEAC America, Inc. could void the user's warranty.

Table of Contents

Safety Precautions	i
Copyright and Trademark Information	i
Piracy Statement	ii
FCC Radio Frequency Interference Regulations	ii
List of Figures	v
About This Manual	v
Chapter 1. Introduction	1
Rackmount DVD/CD Duplicator Package Contents	2
Front Panel	3
Rear Panel	5
Chapter 2. Using the Rackmount DVD/CD Duplicator	7
Setup	7
Basic Operation	9
Copying from the Optical Source Drive	9
Chapter 3. Rackmount DVD/CD Duplicator Functions	11
1 Copy	11
2 Test	11
3 Test & Copy	11
4 Verify	11
5 Compare	12
6 Prescan	12
7 Disc Info	12
8 Select Source	12
9 Image	12
10. Edit Track (for CD only)	13
10.1 CD to CD Edit	13
10.2 CD to HDD	17
10.3 Play Audio Track	17
10.4 Close Session	17
11 Setup	17
11.1 Language	17
11.2 CD Burn Speed	17
11.3 DVD Burn Speed	18
11.4 Read Speed	18
11.5 Auto Start Drive	18
11.6 Startup Menu	18
11.7 Auto Verify	18
11.8 Auto Compare	18
11.9 Auto Prescan	18
11.10 Eject Disc	18
11.11 Burn on the Fly	19
11.12 Burn Mode	19
11.13 Display Time	19
11.14 Button Sound	19

11.15 Device Info	19
11.16 System Info	20
11.17 Quick Erase	20
11.18 Full Erase	20
12 Advanced Setup (Adv Setup)	20
12.1 UnderRun Protect	20
12.2 Overburn	20
12.3 Read Error Skip	21
12.4 Format HDD	21
12.5 Verify HDD	21
12.6 Burn-in	21
12.7 Update Firmware	21
12.8 Compare Firmware	21
12.9 H/W Diagnostic	21
12.10 Load Default	22
12.11 CD+G	22
12.12 ISRC & MCN	22
12.13 CD-Text	22
12.14 Use Big Block	22
Appendix A. List of Functions	23
Appendix B. LCD Messages	24
Normal Conditions	24
Audio Editing	25
Appendix C. Frequently Asked Questions (FAQ)	26
FAQ	27
Appendix D. About DVD±R and DVD±RW Discs	29
Handling Discs	29
Loading and Ejecting Discs	30
Appendix E. Specifications	31
Appendix F. Technical Support	32

List of Figures

Figure 1. Rackmount DVD/CD Duplicator Package Contents	2
Figure 2. Front Panel of Rackmount DVD/CD Duplicator	3
Figure 3. LCD Control Panel	3
Figure 4. Rear Panel of the Rackmount DVD/CD Duplicator	5
Figure 5. Installing the DVD/CD Duplicator in a Rack	7
Figure 6. Copy Function on LCD Panel	8
Figure 7. How to Handle Compact Discs (including DVD±R and DVD±RW)	29
Figure 8. Ejecting the Disc Tray	30

About This Manual

This *2U Rackmount DVD/CD Duplicator User's Manual* explains how to operate the Rackmount DVD/CD Duplicator. It is divided into the following chapters:

Chapter 1: Introduction

This chapter describes the shipping package contents and introduces the Rackmount DVD/CD Duplicator.

Chapter 2: Using the Rackmount DVD/CD Duplicator

This chapter explains how to set up the Rackmount DVD/CD Duplicator. It also describes a basic copy operation.

Chapter 3: Rackmount DVD/CD Duplicator Functions

This chapter explains all available functions of the Rackmount DVD/CD Duplicator.

Appendix A: List of Functions

Appendix A includes a complete list of all Rackmount DVD/CD Duplicator functions.

Appendix B: LCD Messages

Appendix B lists all messages that may appear on the LCD display.

Appendix C: Frequently Asked Questions (FAQ)

Appendix C can help you to resolve technical difficulties that you might encounter.

Appendix D: About DVD±R and DVD±RW Discs

Appendix D contains information about handling, loading, and ejecting discs.

Appendix E: Specifications

Appendix E includes technical specifications for the Rackmount DVD/CD Duplicator.

Appendix F: Technical Support

Appendix F explains how to contact technical support for your Rackmount DVD/CD Duplicator.

Chapter 1. Introduction

Thank you for purchasing a TEAC or TASCAM 2U Rackmount DVD/CD Duplicator.

***Note:** This User's Manual is intended for both TEAC and TASCAM branded Rackmount DVD/CD Duplicators. Operational instructions for both models are essentially the same. The primary differences between the models are the TEAC or TASCAM logo on the LCD control panel and the name plate on the rear panel.*

The Rackmount DVD/CD Duplicator is a stand-alone disc-to-disc DVD/CD Duplicator system that does not require connection to a computer. It can duplicate a single master DVD±R to DVD±R media at up to 20X speeds, resulting in an exact replica of a 4.7GB disc. It can duplicate discs to CD-R/CD-RW media at up to 48X/32X speeds respectively. It can also duplicate discs to DVD±R DL media.

The Rackmount DVD/CD Duplicator is designed to perform DVD and CD copying quickly and accurately. The Rackmount DVD/CD Duplicator automatically identifies source DVD formats and replicates the content as required.

The Rackmount DVD/CD Duplicator performs continuous copying with no waiting. It is an ideal DVD/CD Duplicator for the advanced user who requires speed and accuracy.

You can set up your Rackmount DVD/CD Duplicator very quickly and easily. There is no need to install any software. There is no need to attach any cables to your computer. The Rackmount DVD/CD Duplicator functions entirely as a stand-alone unit.

Rackmount DVD/CD Duplicator Package Contents

Your Rackmount DVD/CD Duplicator package includes the following items (see Figure 1).

- TEAC or TASCAM Rackmount DVD/CD Duplicator unit
- AC power cable
- Rackmount DVD/CD Duplicator System User's Manual* (this booklet)
- Warranty card (not shown)
- Optional rubber feet (not shown)

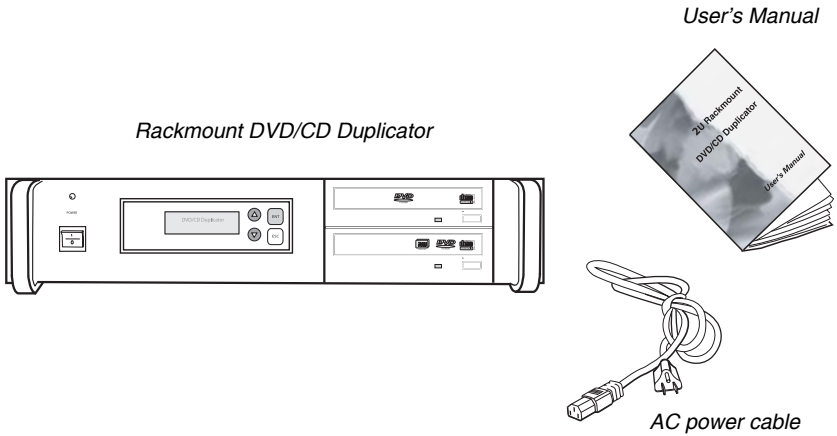

Figure 1. Rackmount DVD/CD Duplicator Package Contents

Note: If any of the items above is missing from your package upon purchase, please contact your vendor immediately.

Front Panel

Figure 2 illustrates the front panel of the Rackmount DVD/CD Duplicator.

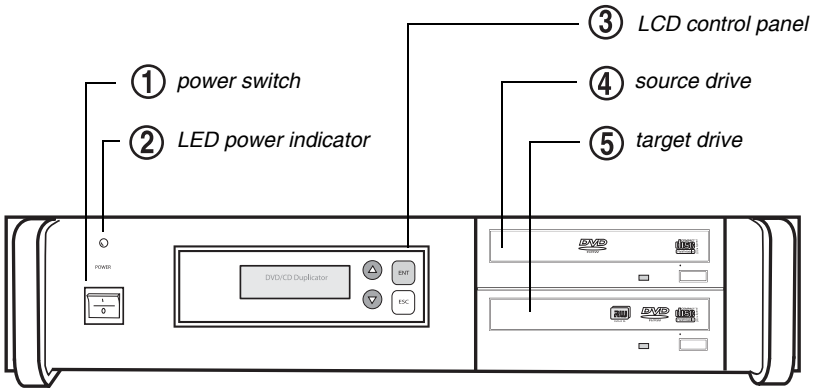

Figure 2. Front Panel of Rackmount DVD/CD Duplicator

- ① **power switch:** Use the power switch to turn the power to the DVD/CD Duplicator unit on or off.
- ② **LED power indicator:** The LED power indicator will be continuously lit when the DVD/CD Duplicator power is on.
- ③ **LCD control panel:** Use the control panel buttons to navigate through the various functions viewed on the LCD display.

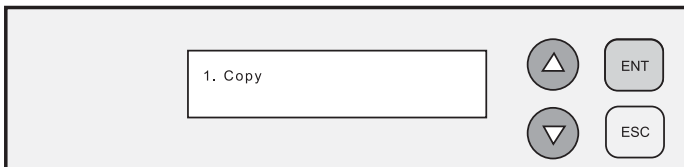





Figure 3. LCD Control Panel

The DVD/CD Duplicator control panel features an LCD display and four buttons. These buttons are described in the following table:

	Press the Up arrow button to scroll up functions or menus.
	Press the Down arrow button to scroll down functions or menus.
	Press the ENT (Enter) button to execute a selected function.
	Press the ESC (Escape) button to cancel a selected function or to return to the main menu.

- ④ **source drive:** Insert the disc to be copied into the source drive. Use the disc tray to load a DVD or CD into the drive. You can open the tray by pressing the Load/Eject button (if the tray fails to open, you can use the emergency eject mechanism). You can close the tray by pressing the Load/Eject button.

***Note:** It is strongly recommended that you do not push the tray in to close it. Please press the Load/Eject button to eject or retract the tray. See Figure 8 on page 30.*

- ⑤ **target drive:** Insert a blank disc into the target drive to make a copy of the source disc. You can open the tray by pressing the Load/Eject button (if the tray fails to open, you can use the emergency eject mechanism). You can close the tray by pressing the Load/Eject button.

***Note:** It is strongly recommended that you do not push the tray in to close it. Please press the Load/Eject button to eject or retract the tray. See Figure 8 on page 30.*

Rear Panel

Figure 4 illustrates the rear panel of the Rackmount DVD/CD Duplicator.

The unit features a cooling fan and an AC Power In connector.

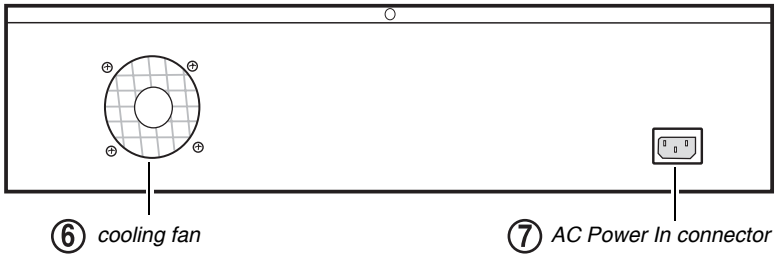

Figure 4. Rear Panel of the Rackmount DVD/CD Duplicator

- ⑥ **cooling fan:** Ball-bearing fan cools the Rackmount DVD/CD Duplicator.
- ⑦ **AC Power In connector:** Connect the included AC power cable to this input connector. Plug the other end of the power cable into a three-prong receptacle AC power outlet.

Caution: Do not attempt to bypass the grounding plug. Otherwise, you risk electrical shock or damage to the unit.

Note: To ensure proper operation, use only the original AC power cable with your DVD/CD Duplicator.

Chapter 2. Using the Rackmount DVD/CD Duplicator

This chapter explains how to set up the Rackmount DVD/CD Duplicator. It also explains basic operation and menu functions.

Note: The following instructions are applicable to TEAC and TASCAM branded Rackmount DVD/CD Duplicators. The primary differences between models are the TEAC or TASCAM logo on the LCD Control Panel and the model number on the corresponding nameplate label. Please refer to “Specifications” on page 31 for detailed information on your model.

Setup

1. Carefully remove the DVD/CD Duplicator unit, AC power cord, warranty card, optional rubber feet and user’s manual from the shipping box.

Note: Please keep the original box and packaging materials for use in the event of future storage or transportation of the unit.

2. If the unit will not be mounted onto a rack, you may wish to affix the four included rubber feet to the bottom of the Rackmount DVD/CD Duplicator. Then skip Step 3 and proceed directly to Step 4.
3. To rack mount the DVD/CD Duplicator, leave a 1U of space above it and 4 inches (10cm) or more of space at the rear. Use a rack-mounting kit (not included) to mount the unit in a standard 19-inch equipment rack, as illustrated below. If rubber feet are currently affixed to the bottom of the unit, remove the rubber feet before you attempt to mount the unit in a rack.

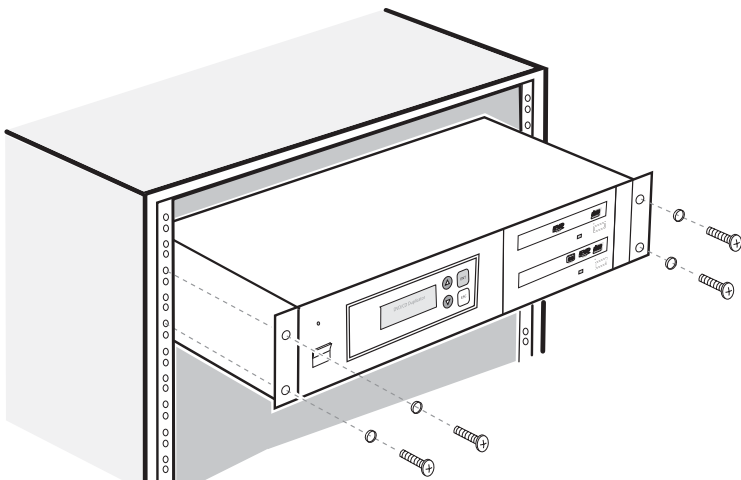

Figure 5. Installing the DVD/CD Duplicator in a Rack

4. Connect one end of the included power cable to the back of the DVD/CD Duplicator. Connect the other end of the power cable to a three-prong receptacle AC outlet.

Caution: Do not attempt to bypass the grounding plug. Otherwise, you risk damage to the unit and electrical shock.

Note: This unit features an internal switching power supply, which will automatically switch within a range of 100 to 240VAC as required.

5. Turn on the power to the DVD/CD Duplicator by pressing the power button on the lower front-center of the unit.

During initialization, the DVD/CD Duplicator performs a self-test in which the unit's internal buffer is tested, source and target drives are detected, and the LCD display is tested. Once the initialization is complete, the DVD/CD Duplicator is ready for use.

The LCD initially displays the Copy function by default.

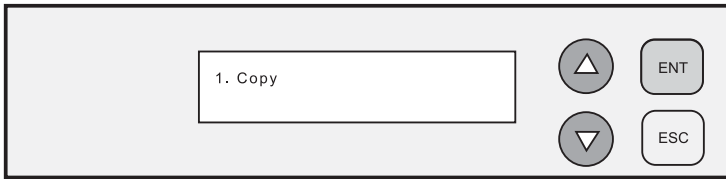

Figure 6. Copy Function on LCD Panel



Basic Operation

This section explains the basic operation of the Rackmount DVD/CD Duplicator.

Copying from the Optical Source Drive

1. Place your DVD/CD source disc in the disc tray of the source drive.

The source drive is located in the upper-right corner of the unit. (Refer to Figure 2 on page 3.)

2. Switch to function [1 Copy] by pressing the  /  buttons (if necessary).

Refer to Figure 6 on page 8.

3. Place a blank DVD/CD disc into the target drive, then press the  (ENT) button to start copying.

Note: *The type and capacity of the target disc must match that of the source disc. For example, if the source disc is a CD-ROM, then the blank target disc must be CD-R disc. If the source disc is a 4.7GB DVD-ROM disc, then the blank target disc must be 4.7GB DVD±R. If the source disc is an 8.5GB Dual Layer (DL) disc, then the blank target disc must be 8.5GB DVD±R DL.*

When the copy operation is complete, the DVD/CD disc in the target drive will be ejected automatically.

If you encounter an error message, please refer to Appendix B: “LCD Messages” on page 24 and Appendix C: “Frequently Asked Questions (FAQ)” on page 26 for troubleshooting information.

Notes:

- ❑ *With the default setting, after a source disc has been successfully copied, the DVD/CD Duplicator automatically ejects the target DVD/CD disc.*
- ❑ *With the default setting, if the copy operation fails, the failed target DVD/CD disc remains in the target drive. To remove the failed DVD/CD disc, press the eject button on the target drive and retrieve the disc. Press the eject button again to retract the disc tray. You can change the default settings by using the [Advanced Setup] menu. (For more information, see “12 Advanced Setup (Adv Setup)” on page 20.)*

Chapter 3. Rackmount DVD/CD Duplicator Functions

The DVD/CD Duplicator features 12 functions: Copy, Test, Test & Copy, Verify, Compare, Prescan, Disc Info, Select Source, Image, Edit Track, Setup, and Advanced Setup. Each function is explained below.

1 Copy

The Copy function enables you to copy data from a source DVD or CD disc or a partition on the internal hard disk drive. For more detailed information, refer to “Basic Operation” on page 9.

Note: You can use DVD±RW discs that already contain data (i.e., DVD±RW discs that are not fully blank) as target discs. However, the data stored on the DVD±RW disc will be erased automatically before the new data is copied. No special setting or procedure is required to erase the old data.

2 Test

The Test function simulates writing to the target disc. Discs will remain blank after the test is complete. This function is recommended if you are using unsupported media. This function enables the target drive to adjust its laser to the proper intensity.

Note: Unexpected termination or cancellation of a test will not affect a target DVD±R disc. The target DVD±R disc will remain blank and available for use. However, DVD±RW discs that contain data may be damaged and the data they contained may be rendered unrecoverable. It may be necessary to re-start the DVD/CD Duplicator if the target drive hangs during a sudden termination.

3 Test & Copy

The Test & Copy function performs the test simulation and the copy process in one step.

The copy process is performed only if the simulation detects no problems. If the simulation fails, the copy process is cancelled.

4 Verify

The Verify function verifies that the target disc was written completely and with no errors.

5 Compare

The Compare function compares data on the source and target discs after the copy process is complete.

Note: This function works only with data discs.

6 Prescan

The Prescan function is performed on the source drive. This function scans the disc to determine the maximum data/audio extraction speed.

7 Disc Info

The Disc Info function displays detailed information about the source disc, including sessions, tracks, capacity, etc.

8 Select Source

The Select Source function is valid only with Duplicators that feature a factory-installed hard disk drive. Please disregard this function.

9 Image

The Image menu, which consists of seven functions (9.1 through 9.7), is valid only with Duplicators that feature a factory-installed hard disk drive. Please disregard these functions.

Note: Since the 2U Rackmount Duplicator does not feature a hard disk drive option, please disregard the following functions:

9.1 Load

9.2 Delete Image

9.3 Image Info

9.4 Compare Image

9.5 Select Image

9.6 Image Src Drive

9.7 Image Format Info

10. Edit Track (for CD only)

The Edit Track functions enable you to create and copy a collection of songs from different audio discs.



Note: The CD+G value must be set to OFF before you can use the Track Extraction feature. For more information, refer to “12 Advanced Setup (Adv Setup)” on page 20.

10.1 CD to CD Edit

You can use this function to copy tracks from one or more discs and burn them to a CD-R.

The CD to CD Edit function enables you to select specific tracks from various audio discs, combine them to create a collection of songs, and copy the collection to blank CD-R/CD-RW discs.

Note: CD-R discs support up to 80 minutes of audio. Therefore, the number of tracks that can be copied onto a single disc depends on the length of each individual track.

1. Insert a source disc into the source optical drive and a blank CD-R disc into the target drive.
2. Switch to function [10.1 CD to CD] by pressing the  button.
3. Press the  (ENT) button.

The LCD panel displays the following:

10-01. Edit Track
CD to CD Edit

Selecting a Track from the First CD

4. Press the  (ENT) button again.

The LCD panel displays the following:

Select Track:
1/10 03:25

In this example, the indicator “1/10” refers to the first (1) of 10 tracks. The value “03:25” indicates the duration of the track.

You can press the  button to display (2) for the second (2) song, and so on.

In this example, we will choose to include the first track on our mix CD.

5. Select the first track, then press the  (ENT) button.



A plus sign (+) will be displayed next to the “1/10” indicator as shown below.

Select Track:
+1/10 03:25

Note: Pressing the  (ENT) button again will cancel your selection.

6. Press the  button to display End in the LCD panel, as shown below.

Select Track:
End 1Trk03:25

7. Press the  (ENT) button to finish CD editing.
8. Press the  /  buttons to display Yes.

**End edit disc
and burn? Yes**

Copying the Track

9. Press the  (ENT) button.

The system starts copying the track and displays the copying information as follows:

Copying - 24X Edit
1/10 -> 1/1

In the display above, the “1/1” indicator refers to the first track selected (1) out of the total number of tracks selected (1).

When the copy process is complete, the LCD panel displays the following message:

Burn Complete!
OK: 01

The system will ask if you want to keep editing.

10. To continue editing, press the  /  buttons to display Yes, as shown below.

**Continue edit
next Disc? Yes**

If you choose not to continue, select No, then skip to Step 18.

Selecting a Track from the Second CD

11. Press the  (ENT) button.

The current source CD will eject automatically, and the system will ask you to insert another source CD:

Insert next disc

12. Insert a different source CD, then press the  (ENT) button to begin the track selection process.

On this disc, we will select the second track.



13. Press the down arrow  to display Track 2 on the LCD panel, then press the  (ENT) button.

The LCD panel will display a plus sign (+) beside the 2/10 indicator as shown below.

**Select Track:
+2/10 04:25**

14. Press the up arrow  to display End in the LCD panel, as shown below.

**Select Track:
End 1Trk04:25**

15. Press the  (ENT) button to finish the CD editing, and then press the  /  buttons to display Yes.

**End edit disc
and burn? Yes**

Copying the Track

16. Press the  (ENT) button.

The system starts copying the track and displays the following copying information:

**Copying - 24X Edit
2/10 -> 2/2**

The indicator “2/2” represents the second (2) of the two (2) tracks we selected from different discs.

When the copy process is complete, the LCD panel displays the following message:

**Burn Complete!
OK: 01**

The system will then ask if you want to continue editing.

**Continue edit
next Disc? No**

In this example, we will choose not to continue.



17. Press the down arrow  to display “No.”

Closing the Session

18. Press the  (ENT) button.

The system will ask if you want to close the session for the CD.

**Close all disc's
session? Yes**

19. Press the  /  arrow buttons to display Yes, then press the  (ENT) button.

Once you indicate that you wish to close the session, the LCD panel will display the message as follows.

Closing Session
Please wait...

***Note:** You must close the session for the CD before you can play the CD.*

10.2 CD to HDD

Since the 2U Rackmount Duplicator does not feature a hard disk drive, please disregard this option.

10.3 Play Audio Track

This function is not available.

10.4 Close Session

This function finalizes your CD-R disc. Once the CD-R disc is finalized, no more audio can be added to that disc.

11 Setup

The Setup menu includes a list of options that enable you to change the original default configuration. Various settings are available under the Setup menu that control the operation of the DVD/CD Duplicator. However, it is recommended that you use the original default settings for optimal operation.

11.1 Language

The DVD/CD Duplicator LCD panel can display text in English and Spanish. The Language function enables you to select the display language. English is the default option.

11.2 CD Burn Speed

The CD Burn Speed setting controls the writing speed of the target drive when recording onto CD-R/CD-RW media. The default value is AUTO, which writes at the highest speed allowed by the media.

11.3 DVD Burn Speed

The DVD Burn Speed setting controls the writing speed of the target drive when recording onto DVD±RW media. The default value is **MAXIMUM**, which writes at the highest speed available on the target drive. On occasion, using the maximum writing speed will cause copy failure due to poor quality DVD±RW discs. In this case, it is recommended that you reduce the writing speed.

11.4 Read Speed

The Read Speed function enables you to set the reading speed of the target drive. **MAXIMUM** is the default setting.

11.5 Auto Start Drive

The Auto Start Drive setting enables the DVD/CD Duplicator to auto-start the copy or test process as soon as a blank disc is inserted into the target drive. The default setting is **OFF**.

11.6 Startup Menu

The Startup Menu setting enables you to select a menu item to be displayed as the first menu item when you turn on the DVD/CD Duplicator. **COPY** is the default.

11.7 Auto Verify

The Auto Verify setting controls auto verification of discs after a copy operation. The default setting is **OFF**.

11.8 Auto Compare

The Auto Compare setting controls auto-comparison of data between source and target discs after a copy operation. The default setting is **OFF**.

11.9 Auto Prescan

The Auto Prescan setting controls automatic prescan of the source disc whenever a data/audio disc is inserted in the optical source drive. The default setting is **OFF**.

11.10 Eject Disc

The Eject Disc setting controls the ejection of discs by the target drive. Three options are available:

- Eject Good Only – This option ejects only successfully copied discs. This is the default setting
- Eject All Disc – This option ejects successful and failed copy discs.
- Do Not Eject – With this option, the disc remains in the target drive. Manual ejection is required after every copy operation.

11.11 Burn on the Fly

The Burn on the Fly function enables you to control the copy operation. When the setting is ON, data is copied directly from the source DVD to the target DVDs. When the setting is OFF, the DVD/CD Duplicator first loads the data into a partition on the hard disk drive, then copies the data to the target DVDs.

11.12 Burn Mode

The Burn Mode setting enables you to select from two writing methods for CD-R media:

- Disc At Once (DAO)
- Track At Once (TAO)

DAO is the default setting.

11.13 Display Time

The Display Time function displays the total time of each copy operation. The default setting is OFF.

11.14 Button Sound

The Button Sound setting turns the button sound on or off. The default setting is ON.

11.15 Device Info

The Device Info function displays information for both the source and target drives.

11.16 System Info

The System Info function displays information for the interface board.

11.17 Quick Erase

The Quick Erase function performs a Quick Erase on DVD±RW discs.



11.18 Full Erase

The Full Erase function performs a Full Erase on DVD±RW discs. This function takes longer than the Quick Erase.

12 Advanced Setup (Adv Setup)

The Advanced Setup functions enable you to modify the system configuration. You should make changes only after you become completely familiar with the functions in this menu.

To enter Advanced Setup mode, press the  (ESC) button for two (2) seconds until you hear a beep.

Then use the down arrow button  to scroll through the various Advanced functions. Press the  (ENT) button to execute any of the Advanced functions.

To exit Advanced Setup mode, press the  (ESC) button twice, then press the down arrow button . The [1 Copy] command will appear on the LCD display.

12.1 UnderRun Protect

The UnderRun Protect setting turns Buffer UnderRun Protection on or off. The default setting is ON.

12.2 Overburn

The Overburn setting turns the Overburn function in the target drive on or off. The default setting is OFF.

For more information about Overburn discs, see item 5 in the FAQ on page 27.

12.3 Read Error Skip

The Read Error Skip setting controls error skipping during reading of the source disc.

If the setting is OFF and an error is detected, the target drive stops and displays the read error message.

If the setting is ON, no messages will be displayed if an error occurs. The copy operation will be completed and the copy will include all errors detected during the process.

The default setting is OFF.

12.4 Format HDD

The Format HDD function is valid only on Duplicators that feature a factory-installed hard disk drive. Please disregard this function.

12.5 Verify HDD

The Verify HDD function is valid only on Duplicators that feature a factory-installed hard disk drive. Please disregard this function.

12.6 Burn-in

The Burn-in function runs an emulate writer function continuously. The disc in the target drive is ejected and re-inserted automatically between each test cycle. This function can be prepared to run continuously or specified to run from 1 to 1000 times.

12.7 Update Firmware

The Update Firmware function updates the firmware of the interface board via a CD or DVD disc. The disc must contain the required data file and be inserted in the source drive. The DVD/CD Duplicator will locate the data and update its firmware automatically. During the update, do not turn off the power to the unit. The update process is complete after the system resets automatically and displays the main menu.

12.8 Compare Firmware



The Compare Firmware function compares the current firmware version in the interface board to the update version in the CD or DVD disc.

12.9 H/W Diagnostic

The H/W Diagnostic function detects the devices connected to the interface board, confirms functionality, and displays information about the hardware on the LCD.

12.10 Load Default



The Load Default function resets all settings to factory default values. It is recommended that you reset to the default values if the DVD/CD Duplicator fails to function properly after you make changes to the original configuration. To execute the Load Default function, follow the steps below:

1. Press and hold down the  (ESC) button for two (2) seconds until you hear a beep.
2. Press the down arrow  to display 12.10 Load Default.
3. Press the  (ENT) button.

The system displays the message: Load Default Config? Yes.

4. Press the  (ENT) button.

The system starts loading the default data. When the loading operation is complete, the system displays the message: Load Default OK.

5. Press the  (ESC) button twice, then press the down arrow  to return to the main menu.

The system displays 1.Copy.

12.11 CD+G

The CD+G function enables or disables CD+G (karaoke CD) format support. The default setting is OFF.

Note: The CD+G value must be set to OFF before you can use the Track Extraction features.

For more information about CD+G discs, see item 7 in the FAQ on page 27.

12.12 ISRC & MCN

The ISRC & MCN function enables or disables ISRC and MCN format support. The default setting is OFF.

12.13 CD-Text

The CD-Text function enables or disables the copying of CD-Text discs. The default setting is OFF.

For more information about CD-Text discs, see item 8 in the FAQ on page 27.

12.14 Use Big Block

This function is not available in the 2U Rackmount Duplicator.

Appendix A. List of Functions

- 1 Copy
- 2 Test
- 3 Test & Copy
- 4 Verify
- 5 Compare
- 6 Prescan
- 7 Disc Info
- 8 Select Source (unavailable function)

- 9 Image (unavailable function)
 - 9.1 Load
 - 9.2 Delete Image
 - 9.3 Image Info
 - 9.4 Compare Image
 - 9.5 Select Image
 - 9.6 Image Src Drive
 - 9.7 ImageFormat Info

- 10 Edit Track (for CD only)
 - 10.1 CD to CD Edit
 - 10.2 CD to HDD (unavailable function)
 - 10.3 Play Audio Track (unavailable function)
 - 10.4 Close Session

- 11 Setup
 - 11.1 Language (Default is English.)
 - 11.2 CD Burn Speed (Default is Auto.)
 - 11.3 DVD Burn Speed (Default is Maximum.)
 - 11.4 Read Speed (Default is Maximum.)
 - 11.5 Auto Start Drive (Default is Off.)
 - 11.6 Startup Menu (Default is Copy.)
 - 11.7 Auto Verify (Default is Off.)
 - 11.8 Auto Compare (Default is Off.)
 - 11.9 Auto Prescan (Default is Off.)
 - 11.10 Eject Disc (Default is Eject Good Only.)
 - 11.11 Burn on the Fly (Default is On.)
 - 11.12 Burn Mode (Default is DAO.)
 - 11.13 Display Time (Default Off.)
 - 11.14 Button Sound (Default is On.)
 - 11.15 Device Info
 - 11.16 System Info
 - 11.17 Quick Erase
 - 11.18 Full Erase

- 12 Advanced Setup (Adv Setup)
 - 12.1 UnderRun Protect (Default is On)
 - 12.2 Overburn (Default is Off)
 - 12.3 Read Error Skip (Default is Off)
 - 12.4 Format HDD (factory use only) (unavailable function)
 - 12.5 Verify HDD (factory use only) (unavailable function)
 - 12.6 Burn-in
 - 12.7 Update Firmware
 - 12.8 Compare Firmware
 - 12.9 H/W Diagnostic
 - 12.10 Load Default
 - 12.11 CD+G (Default is Off)
 - 12.12 ISRC & MCN (Default is Off)
 - 12.13 CD Text (Default is Off)
 - 12.14 Use Big Block (unavailable function)

Appendix B. LCD Messages

This appendix explains the messages that may appear on the LCD panel.

Normal Conditions

Message	Meaning
Initialize SDRAM	Initialize system memory.
Detect drives	Detect the drives connected to the system.
User Abort	Cancel a job during operation.
Analyzing	Analyze the source disc.
Source Drive Not Ready	Source drive is not ready to read.
Target Drive Not Ready	Target drive is not ready to write.
Erasing disc	The system is erasing the data on the disc.
Source Disc Not Ready	Source disc is not ready to be read.
Target Disc Not Ready	Target disc is not ready to be written into.
Fail to get Drive Info!	Drive information cannot be obtained.
Fail to get SRC Disc Info!	Information about a source disc cannot be obtained.
Save new config Fail!	The new configuration settings cannot be saved.
Load Default Config?	Do you want to load the default settings?
Src&Tgt can't in the same channel	During comparison, the source and target discs cannot occupy the same channel.
Preparing	The system is preparing to record.
Check Target Please Wait	The system is checking the target device.
Audio Disc!!!Can't compare!	The system cannot compare the audio disc.
Identical	Comparison results are identical.
Read disc error	During a comparison, the disc could not be read.
Cannot read TOC	The system cannot read the contents of the disc.
TOC not match	Comparison results are not identical.
Source Disc Empty!!!	The source disc contains no data.
Target overflow	The target disc capacity is insufficient to store new data.
Target Disc Not Empty!!!	The target disc still contains data.
Press a Key to Eject Good Disc	Press any key to eject a disc after copying. (Copy successful.)
Press a key to Eject Fail Disc	Press any key to eject a disc after copying. (Copy failed.)
DVD-RW does not Support the Func	DVD-RW does not support this function.
Hold ESC to exit	Press ESC for one second to terminate the test.
All data will be lost, erase?	All data on the disc will be lost. Confirm erasure request.
Erase Finished	The erasing of the data is complete.
No Erasing to Disc in DVD-RW!!	The disc in the DVD-RW drive is not rewritable.

Audio Editing

Message	Meaning
Lost selected Tracks?	Abort and delete the selected tracks.
End edit disc and burn?	Finish the music disc editing and start to copy.
Continue edit next Disc?	Do you want to continue the music disc editing?
Target Overflow Re-Select	The disc capacity is insufficient to store the selected tracks. Please select fewer tracks.
Close all disc's session?	Confirm the closing of disc sessions.
Can't edit HDD	The hard disk cannot be edited as a source audio disc.
NO AUDIO track in this disc	The source disc contains no audio tracks.
Insert next disc	Insert the next audio disc.
Sessions were closed already!	The disc sessions have already been closed.
Burn or Move to partition?	Do you want to copy the data directly to disc or transfer the data to a hard disk partition?
Tgt overflow, del last trk?	Disc capacity is insufficient to store the selected tracks. Do you want to delete the last track?
Ins empty disc Continue?	Do you want to insert a blank disc and continue copying?

Appendix C. Frequently Asked Questions (FAQ)

The following FAQ section may help you to resolve some common problems.

1. How do I reset the unit to its factory settings?

Refer to function “12.10 Load Default” on page 22. Carefully follow the step-by-step instructions.

2. When I tried to copy a disc, the LCD displayed Source Disc Empty!!! and the target drive’s tray was ejected simultaneously. What should I do?

The factory settings may have been changed. Reset the duplicator to the factory default settings. Refer to function “12.10 Load Default” on page 22. Carefully follow the step-by-step instructions.

3. What does the Target Drive Not Ready error message mean?

This message is displayed when the target drive is not ready to record because, for example, a blank disc is dirty or scratched. Clean the target disc. If it has been scratched, replace it with a new one.

Try using a different brand of disc to make sure that the failure is not related to disc specifications or quality.

You may also encounter this problem if you try to use a disc that is not blank. (The Rackmount DVD/CD Duplicator accepts only blank DVD/CD discs in the target drive).

This message may also be displayed if the source disc is copy-protected. In such a case, insert a disc that is not copy-protected. In accordance with applicable laws, the Duplicator is designed to be unable to bypass any copy-protection technology that may be encoded on the source disc.

If the error message continues to appear even with different target or source discs, contact our Technical Support Group.

4. What does the Source Drive Not Ready message mean?

This message is displayed when the source (upper) drive is not ready to read because, for example, the master disc is dirty or scratched. Clean the source disc. If it is scratched, use a different source disc.

The message may also be displayed if the source disc is empty. Be sure to insert a data/music/video disc in the source drive.

This message may also be displayed if the source disc is copy-protected. In such a case, insert a disc that is not copy-protected. In accordance with applicable laws, the duplicator unit is designed to be unable to bypass any copy-protection technology that may be encoded on the source disc.

If the error message continues to appear even with different source discs, contact our Technical Support Group.

5. What does the Target Overflow message mean?

This message may be displayed when the source master CD disc contains data/music in excess of the 700MB/80min disc capacity.

These types of discs are often called “Overburn” discs. Attempting to copy an Overburn disc might generate read errors at the end of the disc, making the disc unreadable in regular CD readers. Although this type of recording is not recommended, this unit is capable of duplicating Overburn discs.

Refer to “12 Advanced Setup (Adv Setup)” on page 20 for more information.

Then, execute function “12.2 Overburn” on page 20 to change the setting to the ON state. Follow the instructions to exit the Advanced Setup first, and then execute the [1. Copy function]. This time, the unit will again display the message and prompt you to continue. Press the  (ENT) button to create an Overburn copy.

This message may be displayed when a source DVD disc is copy-protected, such as a purchased/rented DVD movie/game. There is no Duplicator on the market that can copy these discs, as doing so is a violation of Federal law. Replace the source DVD disc with a non-copy protected disc.

This message may also be displayed if the Source DVD disc has a capacity larger than the DVD disc in the target drive. Make sure that both source and target discs have the same capacity. For example, if the source DVD disc is an 8.5GB capacity disc, make sure the target DVD disc is also an 8.5GB disc.

6. What media is recommended?

For best results, brand-name media is recommended (for example: Memorex, Imation, TDK, Verbatim, Fuji-Film, etc.)

7. How do I copy a CD+G (Karaoke) disc?

The CD+G feature is set to OFF as a default.

Refer to “12 Advanced Setup (Adv Setup)” on page 20 for more information. Then execute function “12.11 CD+G” on page 22 to change the setting to the ON state. Follow the instructions to exit the Advance Setup first, and then execute the [1.Copy] function.

8. How do I copy a CD Text disc?

The CD Text feature is set to “OFF” as a default. Refer to “12 Advanced Setup (Adv Setup)” on page 20.

Then execute function “12.13 CD-Text” on page 22 to change the setting to the ON state. Follow the instructions to exit the Advance Setup first, and then execute the [1.Copy] function.

9. How do I extract audio tracks from different CD discs to create a compilation audio CD?

On the main menu, go to function [10 Edit Track] and press the  (ENT) button.

Press the  (ENT) button to execute the [10.1 CD to CD Edit] function. Follow the step-by-step instructions described on page 13.

Appendix D. About DVD±R and DVD±RW Discs

This appendix explains how to handle, load, and eject compact discs, including DVD±R and DVD±RW discs.

Handling Discs

- ❑ Handle compact discs (including DVD±R and DVD±RW discs) only by their edges to avoid getting fingerprints on the surface of the disc. Do not touch the disc's data surface (unlabeled side).
- ❑ Do not place discs in direct sunlight or in locations subject to high humidity, high temperatures, or dusty conditions.
- ❑ If it becomes necessary to clean a disc due to erratic operation, visible dust, or smudges, gently wipe the surface of the disc from the center to the outside edge. Do not use benzene, alcohol, thinner or other solvents.

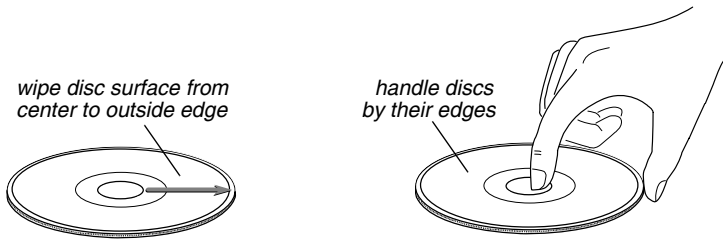

Figure 7. How to Handle Compact Discs (including DVD±R and DVD±RW)

Loading and Ejecting Discs

To load a disc into the source or a target drive, first open the disc tray by pressing the Load/Eject button on the front of the drive. Place the disc on the disc tray with its label side facing up. Then press the Load/Eject button again to retract the disc tray back into the drive.

To eject a disc from the source or a target drive, press the Load/Eject button on the front of the drive to extend the disc tray. Remove the disc from the disc tray and place it in its protective case. Then press the Load/Eject button again to retract the disc tray back into the drive.

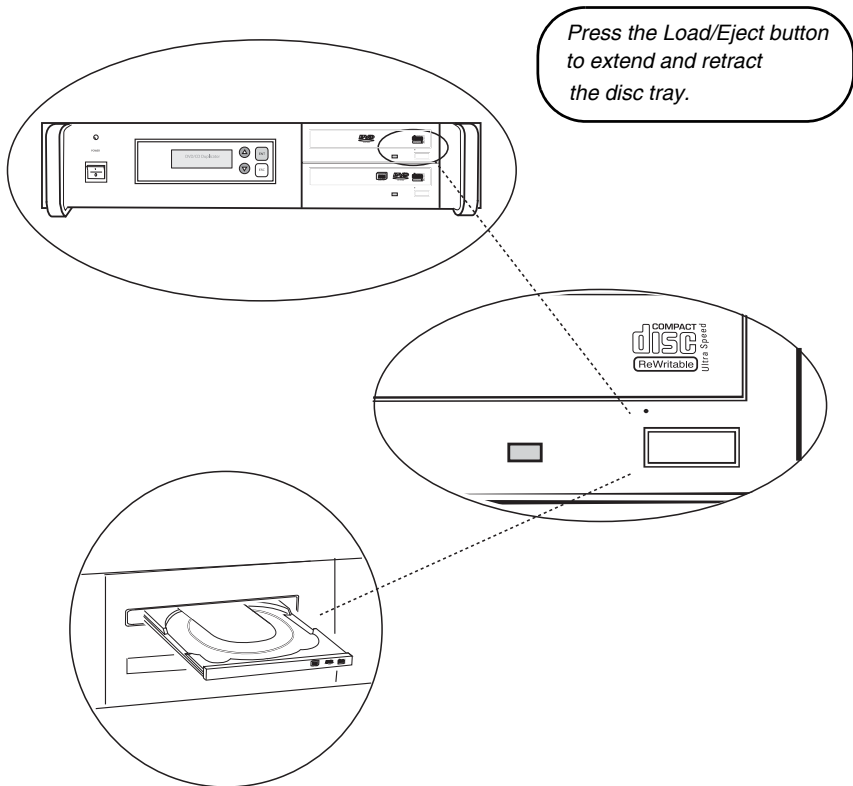

Figure 8. Ejecting the Disc Tray

Appendix E. Specifications

The following table lists the product specifications for the Rackmount DVD/CD Duplicator.

MODEL >		DV-W11R
LCD Panel Logo		TASCAM
DVD Recorder	20X DVD±RW	
DVD Reader	16X DVD-ROM	
Read Speed	DVD: 16x; CD: 48x	
Write Speed	DVD: 20x; CD: 48x	
Drive Buffer Size	2MB	
System Buffer Size	8MB	
Supported Discs	DVD+R, DVD+RW, DVD+DL, DVD-R, DVD-RW, DVD-R DL, CD-R and CD-RW	
System Control	Copy and Search Buttons	
System Display	LCD Panel; LED Indicator	
Write Method	Auto Detect (DAO, TAO)	
Operation Mode	Copy, Test, Scan, Compare	
Firmware Upgrade	Via CD-ROM/DVD-ROM	
Weight	12 lbs.	
Dimensions	3.5 inches H x 17 inches W x 9.5 inches D	
Environment	5° C to 35° C	
Power Supply	AC Input: 100 - 240V	
Agency Certification	UL and FCC	

Appendix F. Technical Support

For technical support, please contact the TEAC and TASCAM Support Center.

Technical Support

Telephone: (323) 727-4860 • Fax: (323) 869-8751

Monday - Friday 8:00 am to 12:00 pm and 1:00 pm to 5:00 pm PST

<http://www.teac.com/support>

E-mail: dspdtsg@teac.com

Free Manuals Download Website

<http://myh66.com>

<http://usermanuals.us>

<http://www.somanuals.com>

<http://www.4manuals.cc>

<http://www.manual-lib.com>

<http://www.404manual.com>

<http://www.luxmanual.com>

<http://aubethermostatmanual.com>

Golf course search by state

<http://golfingnear.com>

Email search by domain

<http://emailbydomain.com>

Auto manuals search

<http://auto.somanuals.com>

TV manuals search

<http://tv.somanuals.com>