

D01124920A

# TASCAM

# DR-V1HD

## HD Video / Linear PCM Recorder

# HDMI®

HIGH-DEFINITION MULTIMEDIA INTERFACE

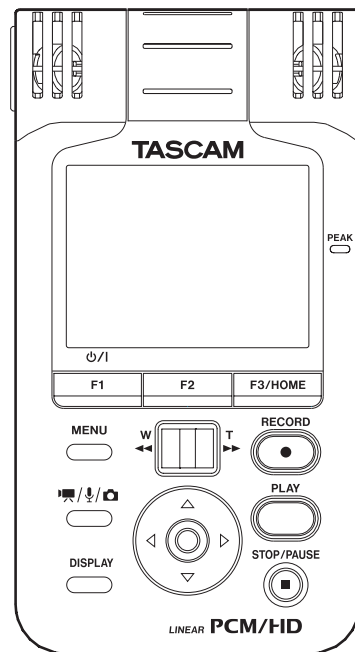

## OWNER'S MANUAL

# IMPORTANT SAFETY PRECAUTIONS

## ■ For U.S.A

### TO THE USER

This equipment has been tested and found to comply with the limits for a Class B digital device, pursuant to Part 15 of the FCC Rules. These limits are designed to provide reasonable protection against harmful interference in a residential installation. This equipment generates, uses, and can radiate radio frequency energy and, if not installed and used in accordance with the instruction manual, may cause harmful interference to radio communications. However, there is no guarantee that interference will not occur in a particular installation. If this equipment does cause harmful interference to radio or television reception, which can be determined by turning the equipment off and on, the user is encouraged to try to correct the interference by one or more of the following measures.

- a) Reorient or relocate the receiving antenna.
- b) Increase the separation between the equipment and receiver.
- c) Connect the equipment into an outlet on a circuit different from that to which the receiver is connected.
- d) Consult the dealer or an experienced radio/TV technician for help.

### CAUTION

Changes or modifications to this equipment not expressly approved by TEAC CORPORATION for compliance could void the user's authority to operate this equipment.

THIS CLASS B DIGITAL APPARATUS COMPLIES WITH CANADIAN ICES-003.  
CET APPAREIL NUMÉRIQUE DE LA CLASSE B EST CONFORME À LA NORME  
NMB-003 DU CANADA.

### Declaration of Conformity

Model Number : DR-V1HD  
Trade Name : TASCAM  
Responsible party : TEAC AMERICA, INC.  
Address : 7733 Telegraph Road, Montebello, California, U.S. A.  
Telephone number : 1-323-726-0303

This device complies with Part 15 of the FCC Rules. Operation is subject to the following two conditions: (1) this device may not cause harmful interference, and (2) this device must accept any interference received, including interference that may cause undesired operation.

This appliance has a serial number located on the rear panel. Please record the model number and serial number and retain them for your records.

Model number \_\_\_\_\_  
Serial number \_\_\_\_\_

# IMPORTANT SAFETY INSTRUCTIONS

- 1 Read these instructions.
- 2 Keep these instructions.
- 3 Heed all warnings.
- 4 Follow all instructions.
- 5 Do not use this apparatus near water.
- 6 Clean only with dry cloth.
- 7 Do not block any ventilation openings. Install in accordance with the manufacturer's instructions.
- 8 Do not install near any heat sources such as radiators, heat registers, stoves, or other apparatus (including amplifiers) that produce heat.
- 9 Do not defeat the safety purpose of the polarized or grounding-type plug. A polarized plug has two blades with one wider than the other. A grounding type plug has two blades and a third grounding prong. The wide blade or the third prong are provided for your safety. If the provided plug does not fit into your outlet, consult an electrician for replacement of the obsolete outlet.
- 10 Protect the power cord from being walked on or pinched particularly at plugs, convenience receptacles, and the point where they exit from the apparatus.
- 11 Only use attachments/accessories specified by the manufacturer.
- 12 Use only with the cart, stand, tripod, bracket, or table specified by the manufacturer, or sold with the apparatus. When a cart is used, use caution when moving the cart/apparatus combination to avoid injury from tip-over.



- 13 Unplug this apparatus during lightning storms or when unused for long periods of time.
- 14 Refer all servicing to qualified service personnel. Servicing is required when the apparatus has been damaged in any way, such as power-supply cord or plug is damaged, liquid has been spilled or objects have

fallen into the apparatus, the apparatus has been exposed to rain or moisture, does not operate normally, or has been dropped.

- The apparatus draws nominal non-operating power from the AC outlet with its POWER or STANDBY/ON switch not in the ON position.
- The mains plug is used as the disconnect device, the disconnect device shall remain readily operable.
- Caution should be taken when using earphones or headphones with the product because excessive sound pressure (volume) from earphones or headphones can cause hearing loss.
- If you are experiencing problems with this product, contact TEAC for a service referral. Do not use the product until it has been repaired.

## CAUTION

- Do not expose this apparatus to drips or splashes.
- Do not place any objects filled with liquids, such as vases, on the apparatus.
- Do not install this apparatus in a confined space such as a book case or similar unit.
- The apparatus should be located close enough to the AC outlet so that you can easily grasp the power cord plug at any time.
- If the product uses batteries (including a battery pack or installed batteries), they should not be exposed to sunshine, fire or excessive heat.

## WARNING

Products with Class I construction are equipped with a power supply cord that has a grounding plug. The cord of such a product must be plugged into an AC outlet that has a protective grounding connection.

# Safety Information

## ■ For European Customers

### Disposal of electrical and electronic equipment

- (a) All electrical and electronic equipment should be disposed of separately from the municipal waste stream via designated collection facilities appointed by the government or the local authorities.
- (b) By disposing of the electrical and electronic equipment correctly, you will help save valuable resources and prevent any potential negative effects on human health and the environment.
- (c) Improper disposal of waste equipment can have serious effects on the environment and human health as a result of the presence of hazardous substances in electrical and electronic equipment.
- (d) The crossed out wheeled dust bin symbol indicates that electrical and electronic equipment must be collected and disposed of separately from household waste.



- (e) The return and collection systems are available to the end users. For more detailed information about disposal of old electrical and electronic equipment, please contact your city office, waste disposal service or the shop where you purchased the equipment.

### Disposal of batteries and/or accumulators

- (a) Waste batteries and/or accumulators should be disposed of separately from the municipal waste stream via designated collection facilities appointed by the government or the local authorities.
- (b) By disposing of waste batteries and/or accumulators correctly, you will help save valuable resources and prevent any potential negative effects on human health and the environment.
- (c) Improper disposal of waste batteries and/or accumulators can have serious effects on the environment and human health as a result of the presence of hazardous substances in batteries and/or accumulators.
- (d) The crossed out wheeled dust bin symbol indicates that batteries and/or accumulators must be collected and disposed of separately from household waste.

If the battery or accumulator contains more than the specified values of lead (Pb), mercury (Hg), and/or cadmium (Cd) defined in the Battery Directive (2006/66/EC), then the chemical symbols for lead (Pb), mercury (Hg) and/or cadmium (Cd) will be indicated beneath the crossed out wheeled dust bin symbol.



**Pb, Hg, Cd**

- (e) The return and collection systems are available to the end users. For more detailed information about disposal of waste batteries and/or accumulators, please contact your city office, waste disposal service or the shop where you purchased them.

## CAUTIONS ABOUT BATTERIES

This product uses batteries. Misuse of batteries could cause a leak, rupture or other trouble. Always abide by the following precautions when using batteries.

- Never recharge non-rechargeable batteries. The batteries could rupture or leak, causing fire or injury.
- When installing batteries, pay attention to the polarity indications (plus/minus (+/-) orientation), and install them correctly in the battery compartment as indicated. Putting them in backward could make the batteries rupture or leak, causing fire, injury or stains around them.
- When you store or dispose batteries, isolate their terminals with insulation tape or something like that to prevent them from contacting other batteries or metallic objects.
- When throwing used batteries away, follow the disposal instructions indicated on the batteries and the local disposal laws.
- Do not use batteries other than those specified. Do not mix and use new and old batteries or different types of batteries together. The batteries could rupture or leak, causing fire, injury or stains around them.

- Do not carry or store batteries together with small metal objects. The batteries could short, causing leak, rupture or other trouble.
- Do not heat or disassemble batteries. Do not put them in fire or water. Batteries could rupture or leak, causing fire, injury or stains around them.
- If the battery fluid leaks, wipe away any fluid on the battery case before inserting new batteries. If the battery fluid gets in an eye, it could cause loss of eyesight. If fluid does enter an eye, wash it out thoroughly with clean water without rubbing the eye and then consult a doctor immediately. If the fluid gets on a person's body or clothing, it could cause skin injuries or burns. If this should happen, wash it off with clean water and then consult a doctor immediately.
- The unit power should be off when you install and replace batteries.
- Remove the batteries if you do not plan to use the unit for a long time. Batteries could rupture or leak, causing fire, injury or stains around them. If the battery fluid leaks, wipe away any fluid on the battery compartment before inserting new batteries.
- Do not disassemble a battery. The acid inside the battery could harm skin or clothing.

## ■ For China

产品有毒有害物质或元素的名称及含量

机种：DR-V1HD		有毒有害物质或元素					
	品名	铅 (Pb)	汞 (Hg)	镉 (Cd)	六价铬 (Cr(VI))	多溴联苯 (PBB)	多溴二苯醚 (PBDE)
1	CHASSIS部份	○	○	○	○	○	○
2	PCB Assy部份	×	○	○	○	○	○
3	线材部份	○	○	○	○	○	○
4	附属品部份	×	○	○	○	○	○
7	SEAL部份	○	○	○	○	○	○
8	包装部份	○	○	○	○	○	○

○：表示该有毒有害物质在该部件所有均质材料中的含量均在 SJ/T11363-2006 标准规定的限量要求以下。

×：表示该有毒有害物质至少在该部件的某一均质材料中的含量超出 SJ/T11363-2006 标准规定的限量要求。

(针对现在代替技术困难的电子部品及合金中的铅)

# Contents

<b>IMPORTANT SAFETY PRECAUTIONS.....</b>	<b>2</b>
<b>IMPORTANT SAFETY INSTRUCTIONS .....</b>	<b>3</b>
<b>Safety Information.....</b>	<b>4</b>
<b>Contents.....</b>	<b>6</b>
<b>1 – Introduction.....</b>	<b>9</b>
Features .....	9
Items included with the product.....	10
Conventions used in this manual .....	10
Trademarks.....	11
About microSD cards .....	12
Precautions for use.....	12
Precautions for placement and use.....	12
Beware of condensation .....	13
Cleaning the unit .....	13
Cleaning the lens.....	13
User registration.....	13
<b>2 – Names and Functions of Parts.....</b>	<b>14</b>
Top panel .....	14
Rear panel.....	16
Left side panel.....	16
Right side panel.....	17
Bottom Panel.....	17
Home Screen .....	18
Video and Audio modes.....	18
Photo mode.....	23
Menu structure .....	25
Using menus .....	26
Basic operation.....	27
<b>3 – Preparation .....</b>	<b>29</b>
Powering the unit.....	29
Power supply options.....	29
Using AA batteries.....	29
Using an AC adaptor (sold separately) .....	29
Turning the power ON and OFF .....	30
Turning the power ON .....	30
Turning power off (standby).....	31
Setting the date and time .....	31
Inserting and removing microSD cards .....	32
Inserting the card.....	32
Removing the card .....	33
Preparing a microSD card for use.....	33
Using the built-in speaker .....	34
Connecting monitors and headphones .....	34
Setting the operating mode .....	35
<b>4 – Video/Audio Recording .....</b>	<b>36</b>
Setting the operating mode .....	36
Setting the audio file recording format, sampling frequency and video image resolution.....	36
Available recording time indicator.....	37
Set where to save files .....	37
Preparing the recording inputs.....	38
Placement when recording with the built-in mic .....	40
Connecting an external mic or device .....	40
Recording with an external microphone (MIC IN) .....	40
Recording with an external device (LINE IN).....	41
Adjusting the input level .....	41
Recording (video/audio) .....	43
Adjusting camera magnification.....	44
Overwriting recorded audio with the input signal (After Rec).....	44
Selecting the file to overwrite .....	44
Using the after recording function.....	45
Dividing a recording while continuing to record .....	45

Manually starting a new file while recording .....	45	Setting a folder as the playback area on the BROWSE screen (method 2) ..	64
Automatic recording division at maximum file size .....	46	Playlist .....	65
Automatic recording functions (AUTO REC) .....	46	Adding files to a playlist .....	66
Prerecording a few seconds before recording starts (PRE REC) .....	48	Editing a playlist .....	66
Setting the white balance .....	49	Skipping to select files for playback .....	68
Using the self-timer to delay recording .....	50	Playback .....	68
Capturing an image for audio file background .....	50	Pausing and stopping playback .....	68
Dividing a file (DIVIDE) .....	51	Searching backward and forward .....	69
Recording durations .....	53	Search speed adjustment .....	69
<b>5 – Taking still photos .....</b>	<b>54</b>	Setting the search speed .....	70
Setting the operation mode .....	54	Repeat playback (REPEAT) .....	70
Setting the image size .....	54	Looping playback .....	71
Set where to save photo files .....	54	Using VSA playback .....	72
Using the zoom in photo mode .....	55	Setting the playback speed (method 1) .....	72
Using the self-timer in photo mode .....	55	Setting the playback speed (method 2) .....	73
Taking photos .....	55	Deleting the selected file .....	73
<b>6 – Working with files and folders on the BROWSE screen .....</b>	<b>56</b>	Uploading to video sharing sites .....	74
Setting the operation mode before using the BROWSE screen .....	56	<b>8 – Viewing a slide show of still photos .....</b>	<b>75</b>
Navigating the BROWSE screen .....	56	Setting the operation mode .....	75
BROWSE screen contents .....	57	Setting the time each photo is shown .....	75
Thumbnail display mode .....	57	Playing the slide show .....	76
List mode .....	58	Stopping the slide show .....	76
Icons shown in list view .....	58	<b>9 – Connecting with a computer .....</b>	<b>77</b>
File operations .....	59	Transferring files to a computer .....	78
Folder operations .....	60	Transferring files from a computer .....	78
<b>7 – Video and Audio Playback .....</b>	<b>61</b>	Disconnecting from a computer .....	78
Setting the operation mode for playback .....	61	<b>10 – Making other settings and viewing information .....</b>	<b>79</b>
Adjusting playback volume .....	61	Viewing File Information (INFORMATION) .....	79
Setting the playback area .....	62	INFORMATION (FILE) screen .....	79
Setting a folder as the playback area on the BROWSE screen (method 1) ..	63	INFORMATION (CARD) screen .....	80
		INFORMATION (SYSTEM) screen .....	80

# Contents

System settings (SETUP screen) .....	81
Using the AUTO OFF function.....	81
Using the backlight auto off function .....	81
Adjusting the backlight brightness .....	81
Setting the battery type .....	81
Setting the format of file names.....	82
File name format .....	82
Setting the WORD item .....	82
Formatting.....	83
Restoring the default settings .....	84
<b>11 – Messages .....</b>	<b>85</b>
<b>12 – Troubleshooting .....</b>	<b>87</b>
<b>13 – Specifications .....</b>	<b>89</b>
Media and formats .....	89
Inputs and outputs .....	89
Analog audio input and output .....	89
Digital connections.....	90
Audio performance.....	90
Computer compatibility .....	91
Other specifications .....	91
Dimensional drawings.....	92
<b>14 – Important notice regarding software .....</b>	<b>93</b>
Software License Agreement.....	93
Notice regarding software that uses the GNU GPL.....	94
About the licensing of software used in this product.....	94
GNU GENERAL PUBLIC LICENSE Version 2, June 1991 .....	95
Notice regarding software that uses the BSD .....	100
BSD .....	100



Thank you very much for purchasing a TASCAM DR-V1HD HD Video/Linear PCM Recorder.

Please read this Owner's Manual carefully in order to maximize your use of all the unit's features. We hope that you will enjoy using this recorder for many years to come. After you have finished reading this manual, please keep it in a safe place for future reference.

You can also download this Owner's Manual from the TASCAM website (<http://tascam.com/>).

---

## Features

---

- Compact HD video and linear PCM recorder uses microSD/SDHC cards as recording media
- Directional microphones enable high-quality stereo recording
- Supports 1280 x 720p HD mode
- Camera lens and microphone can be rotated 180 degrees, enabling self-recording
- 1x to 4x digital zoom (in 0.1 increments)
- Video, audio and photo modes
- Can take still pictures as a digital camera
- Linear PCM (WAV format) recording possible at 44.1, 48 or 96 kHz and 16 or 24-bit
- HD video display on a TV possible using the mini-HDMI PORT (Type C)
- 2.4-inch 240x320 TFT Color LCD display
- Can show slide shows with 1-10 second intervals between still images
- Using the After Rec function, while playing back a recorded video file you can overwrite the playback sound with the input sound and record it as a new file
- Built-in 0.6W mono speaker
- Allows monitoring throughs recording (audio or video) to start automatically when the set audio input level is detected
- When the 2GB maximum file size is reached, audio and video recording can automatically continue in a new file without interruption
- File incrementing and auto-recording functions can be used together to create new files when desired without interrupting recording (audio or video)
- Pre-recording function allows capture of up to 2 seconds of audio or video before recording is activated manually
- Automatic gain control function automatically adjusts input levels to make recording levels as uniform as possible
- Limiter function automatically reduces the input level suitably when it is too high
- Low cut filter function reduces low-frequency noise
- VSA function changes playback speed from 50% to 150% (in 10% increments) of normal speed without changing pitch
- Repeat playback and IN-OUT loop playback functions
- Playlist function
- Auto power-off function can be set to 3, 5, 10 or 30 minutes, or OFF
- Divide function allows files to be split where desired
- File name format can be set to use a user-defined word or the date
- 1/8" input jack for line input and external stereo microphones can provide plug-in power
- 1/8" line/headphones output jack
- Mini-B type USB 2.0 port
- Operates on 3 AA batteries or a TASCAM PS-P520 AC adapter (sold separately)
- Tripod attachment socket built into unit

# 1 – Introduction

## Items included with the product

The DR-V1HD package contains the following items.

Take care when opening the package not to damage the items. Keep the package materials for transportation in the future.

Please contact TASCAM if any of these items are missing or have been damaged during transportation.

- Main unit..... ×1
- microSD card (inside unit)..... ×1
- AA alkaline batteries ..... ×3
- USB cable (0.8 m)..... ×1
- Owner's Manual (this document) ..... ×1

## Conventions used in this manual

The following conventions are used in this manual.

- Names of buttons, controls and other physical parts of this unit and other devices appear like this: MENU
- Text displayed on the unit's screen appears like this: □H
- The three buttons (F1, F2 and F3) under the display are function buttons. Functions shown at the bottom of screens will sometimes be shown next to button names.
- Example: **F1**(⏻ / |) button (YES)
- "microSD memory card" is sometimes abbreviated as "microSD card".
- Text displayed on a computer monitor appears like this: "OK"
- Additional information is introduced under the following headings.

### TIP

These are hints and tips same n about ways to use the DR-V1HD.

### NOTE

These provide additional explanations for special situations.

### CAUTION

These indicate that a person could be injured, the device could be damaged, or data (recordings) could be lost if you do not follow the instructions.

## Trademarks

- TASCAM is a trademark of TEAC Corporation, registered in the U.S. and other countries.
- The terms HDMI and HDMI High-Definition Multimedia Interface, and the HDMI Logo are trademarks or registered trademarks of HDMI Licensing LLC in United States and other countries.
- microSDHC Logo is a trademark of SD-3C, LLC.



- Microsoft, Windows, Windows XP, Windows Vista, and Windows 7 are either registered trademarks or trademarks of Microsoft Corporation in the United States and/or other countries.
- Apple, Macintosh, iMac, Mac OS and Mac OS X are trademarks of Apple Inc.
- Other company names, product names and logos in this document are the trademarks or registered trademarks of their respective owners.

Any data, including, but not limited to information, described herein are intended only as illustrations of such data and/or information and not as the specifications for such data and/or information. TEAC Corporation disclaims any warranty that any use of such data and/or information shall be free from infringement of any third party's intellectual property rights or other proprietary rights, and further, assumes no liability of whatsoever nature in the event of any such infringement, or arising from or connected with or related to the use of such data and/or information.

This product is designed to help you record and reproduce sound works to which you own the copyright, or where you have obtained permission from the copyright holder or the rightful licensor. Unless you own the copyright, or have obtained the appropriate permission from the copyright holder or the rightful licensor, your unauthorized recording, reproduction or distribution thereof may result in severe criminal penalties under copyright laws and international copyright treaties. If you are uncertain about your rights, contact your legal advisor. Under no circumstances will TEAC Corporation be responsible for the consequences of any illegal copying performed using the recorder.

# 1 – Introduction

---

## About microSD cards

---

This unit uses microSD cards for recording and playback.

You can use 64 MB–2 GB microSD cards and 4 GB–32 GB microSDHC cards with this unit.

Operation with all microSD cards is not guaranteed.

A list of microSD cards that have been tested with this unit can be found on the TASCAM website (<http://tascam.com/>). You can also contact TASCAM Customer Support.

---

## Precautions for use

---

microSD cards are delicate media. In order to avoid damaging cards or the card slot, please take the following precautions when handling them.

- Do not leave in extremely hot or cold places.
- Do not leave them in extremely humid places.
- Do not let them get wet.
- Do not put things on top of them or twist them.
- Do not subject them to great force.

---

## Precautions for placement and use

---

- The guaranteed operating temperature range is between 0° C and 35° C
- Do not install in the following types of places. Doing so could degrade the sound quality and/or cause malfunctions.
  - Places with significant vibrations
  - Near windows or other places exposed to direct sunlight
  - Near heaters or other extremely hot places
  - Extremely cold places
  - Places with bad ventilation or high humidity
  - Very dusty places
  - Places exposed to rainfall or other direct water
- If this unit is placed near equipment that contains a large transformer, such as a power amplifier, a humming sound could occur. In such a case, increase the distance or between the equipment or change their orientations.
- If this unit is operated near a TV or radio, color irregularity might occur on the TV screen or noise might be generated by the radio. If this occurs, move this unit away from the other device.
- If a cell phone or other wireless equipment is used close to this unit, the operation of the mobile equipment might cause noise in this unit. In such a case, keep such devices away from this unit or turn them off.
- Avoid installing this unit on top of any heat-generating electrical device such as a power amplifier.
- Leaving the lens pointed toward the sun could damage the unit.

---

## Beware of condensation

---

If the unit is moved from a cold to a warm place, or used after a sudden temperature change, condensation could occur. To prevent this, or if this occurs, let the unit sit for one or two hours at the new room temperature before using it. In particular, using the camera lens to record or take still pictures while condensation remains could degrade the quality of the image.

---

## Cleaning the unit

---

Use a dry soft cloth to wipe the unit clean. Do not clean the unit with a chemically treated cloth or substances such as thinner or alcohol. Doing so could damage the surface or change the color of the unit.

---

## Cleaning the lens

---

If the lens is dirtied by fingerprints or oil, for example, use a soft cloth or photographic lens tissues to wipe its surface clean.

---

## User registration

---

See the end of this manual for details about user registration.

## 2 – Names and Functions of Parts

### Top panel

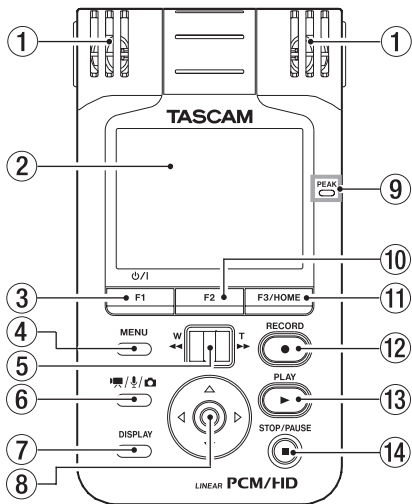

#### ① Built-in stereo microphone

This is a cardioid stereo electret condenser microphone. To use this mic as the input source, set **INPUT SELECT** to **MIC** on the **Input Setting** screen. When an external microphone or line input is connected to the **MIC/LINE IN** jack on the right side panel, however, this built-in mic is disabled.

#### ② Display

This 2.4-inch TFT color LCD display has a resolution of 240x320 and shows video images, still images and a variety of information.

#### ③ F1 (⏻ / I) button

Press and hold this button to turn the unit's power ON or OFF. This button's function when pressed momentarily changes depending on what is shown on the display. The current function is shown at the bottom of the display just above the button. (See "Basic operation" on page 27.)

#### ④ MENU button

When the Home Screen is open, press this button to open the MENU Screen. Press this button to return to the MENU Screen from the various setting screens. When the MENU Screen is open, press this button to return to the Home Screen.

#### ⑤ Zoom control

When in video recording or photo mode, use this when in recording standby to adjust the digital zoom. Press toward **W** [◀◀] to zoom out and toward **T** [▶▶] to zoom in. During video or audio playback, press toward **W** [◀◀] to search backward, or toward **T** [▶▶] to search forward.

#### ⑥ MODE button

When stopped, press this button to change the operating mode.



→ Video mode → Audio mode → Photo mode →

#### NOTE

Only files supported by the operating mode selected using this button will be displayed on the **BROWSE** or **PLAYLIST** screen.

The following file formats can be used for recording/playback, according to the mode.

Video mode:	.mov
Audio mode:	.wav
Photo mode:	.jpg

### ⑦ **DISPLAY button**

Press this button to hide information on the screen and show only the image. Press this button again to show the information again. When the **DIMMER** item on the **SETUP** screen is set to **ALL OFF**, press this button to illuminate the display for a few seconds. Indicators will only light if the normal conditions that cause them to light are met (for example, the **REC** indicator appears only during recording).

### ⑧ **Pointing Stick**

Press the center to confirm a selection on a setting screen. When a setting screen is open, press up (▲) to move the cursor up on the screen. When the Home Screen is open, press up (▲) to raise the output volume. When a setting screen is open, press down (▼) to move the cursor down on the screen. When the Home Screen is open, press down (▼) to lower the volume. When a setting screen is open, press left (◀) to move the cursor left on the screen. When playing or stopped in the middle of a song/video, press left (◀) to return to the beginning of the song/video. When stopped at the beginning of a song/video, press left (◀) to skip to the beginning of the previous file. On the **BROWSE** Screen, press left (◀) to move up a level. When a setting screen is open, press right (▶) to move the cursor right on the screen. During playback or when stopped, press right (▶) to skip to the next file. On the **BROWSE** Screen, press right (▶) to open a folder.

### ⑨ **PEAK indicator**

This lights red when recording when the audio volume level reaches -2dB, which is just before it becomes too high and clips.

### ⑩ **F2 button**

This button's function changes depending on what is shown on the display. The current function is shown at the bottom of the display just above the button. (See "Basic operation" on page 27.)

### ⑪ **F3/HOME button**

This button's function changes depending on what is shown on the display. The current function is shown at the bottom of the display just above the button. (See "Basic operation" on page 27.) When any setting screen is open, press this button to return to the Home Screen.

### ⑫ **RECORD [●] button**

Press when stopped to start recording (video/audio/photo) standby. Press during recording standby when in video or audio recording mode to start recording. The **REC** indicator lights when recording. Press when recording (video/audio) to pause recording. When in recording standby in photo mode, press this button to take a still photo.

### ⑬ **PLAY [▶] button**

When the Home Screen is open and playback is stopped, press this button to start playback. In photo mode, press this button to start a slide show. When paused, press this button to resume playback from the paused point. In photo mode, press this button to start a slide show. When the unit is stopped, paused or playing back, press and hold this button to open the **BROWSE** screen or a playlist screen, whichever was open last.

### ⑭ **STOP/PAUSE [■] button**

Press this button during playback to pause playback. When playback is paused, press this button to return to the beginning of the file and stop playback. Press this button during recording standby (video, audio or photo) to enable recording standby for the current mode. Press this button during recording standby (video or audio) to end recording standby.

## 2 – Names and Functions of Parts

### Rear panel

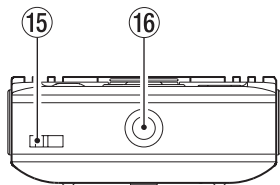

15 **Hole for strap**

Attach a strap here.

16 **Tripod mounting thread (1/4-inch)**

Use this to attach the recorder to a tripod.

#### CAUTION

- Tighten the unit securely to the tripod to prevent it from falling off.
- Place the tripod on a level surface when using it with this unit.
- As some tripods use different types of screw threads, it might not be possible to attach the unit directly. In such a case, use a commercially available adaptor.
- If the tripod screw is longer than standard, you might not be able to attach the unit to the tripod securely. In such a case, use a washer or other type of spacer between the unit and the tripod mount to attach it securely.

### Left side panel

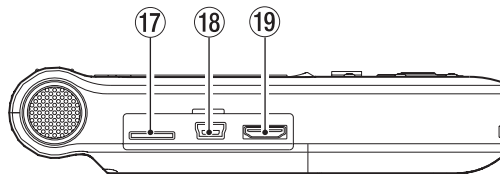

17 **microSD card slot**

Insert a microSD into this slot. (See "Inserting and removing microSD cards" on page 32.)

18 **USB port**

Use the included USB cable to connect the unit to a computer. (See "9 – Connecting with a computer" on page 77.)

#### CAUTION

- The unit should be connected directly to the computer. Do not use a USB hub between the unit and the computer.
- The unit cannot receive bus power from a USB connection, meaning that the batteries will be used even when you connect the unit to a USB port.

19 **mini-HDMI PORT (Type C)**

Use a mini-HDMI PORT (Type C) cable (sold separately) to connect this port with a television, for example, and output video playback. You can use this to enjoy higher image and sound quality on an HDMI-compatible TV.

#### CAUTION

If the audio bit-length of the playback file is 24-bit, the sound will be converted to 16-bit when output from the HDMI connector.

#### NOTE

When the unit is set to SD-VGA, icons and information are shown at full size on the screen, but when set to HD-720p, they are shown smaller at the top left of the screen.



### Right side panel

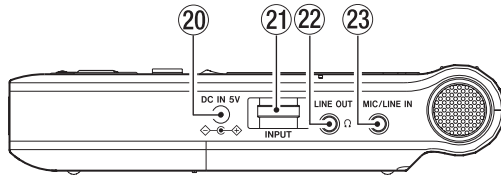

- 20 **DC IN 5V jack**  
Connect a TASCAM PS-P520 AC adaptor (sold separately) here.
- 21 **INPUT level control**  
Turn to adjust the input signal levels of the built-in mic and **MIC/LINE IN** jack.
- 22 **LINE OUT jack**  
Connect headphones or the line input jack of an amp or other equipment.
- 23 **MIC/LINE IN jack**  
Use this stereo mini-jack (3.5 mm) to connect an external mic or other external line level device.  
This jack supports plug-in power microphones. Use the **PLUG IN POWER** item on the **Input Setting** screen to enable this.

### Bottom Panel

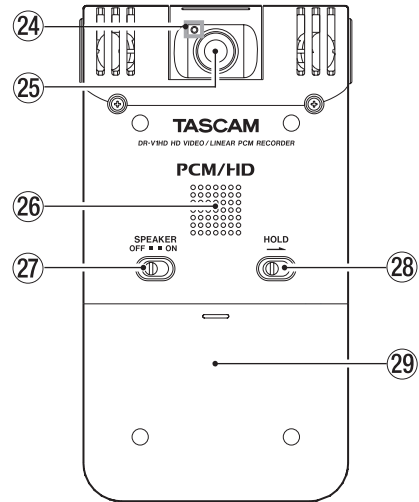

- 24 **REC indicator**  
This indicator lights when recording (video and audio). When using the self-timer, it blinks during the countdown.
- 25 **Lens**
- 26 **Mono speaker**  
Use this built-in speaker to listen to recordings.

## 2 – Names and Functions of Parts

### 27 SPEAKER switch

Set this to ON to output sound from the built-in speaker.

Even when ON, no sound will be output in the following situations.

- When recording and in recording standby (video/audio)
- When headphones or another device is connected to the  $\Omega$ /LINE OUT port

### 28 HOLD switch

Setting this switch in the direction of the arrow, enables the hold function that prevents accidental operation. In this state, all other buttons are disabled.

### 29 Battery compartment cover

### 30 Battery compartment

Install batteries (3 AA) in this compartment to power the unit. (See "Using AA batteries" on page 29.)

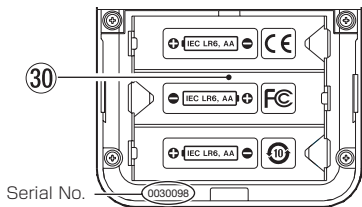

## Home Screen

### Video and Audio modes

#### ■ Appearance during playback and when stopped

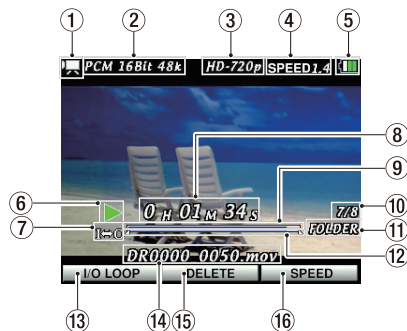

#### 1 Operating mode

This icon shows the current operating mode.

- : Video mode
- : Audio mode
- : Photo mode

#### 2 File format/sampling frequency of current file

This shows the file format and sampling frequency of the currently active file.

### ③ Image resolution indicator

This shows the image resolution.

Indicator	Meaning
None	Audio mode, no captured still photo
0.3M	Audio mode with 640x480 captured still photo
0.9M	Audio mode with 1280x720 captured still photo
SD-VGA	Video mode at SD resolution
HD-720p	Video mode at HD resolution



### ④ Playback speed setting

Shows the current playback speed (0.5–1.5).

Examples : SPEED 0.5  
SPEED 1.5

### ⑤ Power supply status

A battery icon appears when the unit is powered by batteries.

When batteries are being used, the icon shows the amount of power remaining in bars( , ,  ).

When the  icon starts flashing, the batteries are almost dead and the power will turn off soon. If the icon starts flashing during recording (audio/video), the unit will end recording and power off.

When the unit is being powered by a TASCAM PS-P520 AC adaptor (sold separately),  will be displayed.

#### NOTE

Sometimes a Battery empty warning appears when recording (audio/video) or conducting other demanding operations even when some battery power still remains.

### ⑥ Operation indicator

This icon shows the operation status

 : Stopped

 : Paused

 : Playing back

 : Searching forward

 : Searching backward

### ⑦ IN-OUT loop playback/repeat playback/divide mode setting indicator

None : No repeat or loop function active

 : Repeat playback ON  
Selected area is played back repeatedly.

 : Single repeat playback ON  
Selected file is played back repeatedly.

 : IN/OUT loop playback ON  
Area between IN (start) and OUT (end) points are played back repeatedly in a loop.

 : Divide mode  
Only selected file is played back repeatedly.

## 2 – Names and Functions of Parts

### ⑧ Elapsed time

This shows the elapsed time (hours: minutes: seconds) of the file being played.

### ⑨ Playback position display

This bar shows the current playback position. As playback progresses, the bar extends from left to right.

### ⑩ Playback file number/Total number of files

This shows the total number of files in the selected playback area and the number of the current file.

### ⑪ Playback area display

This shows the current playback file area.

ALL : All files on the microSD card

FOLDER : All files in the selected folder (including files in sub-folders)



PLIST : All files added to the playlist

### ⑫ IN-OUT loop playback points

These icons show the loop playback starting (IN) and ending (OUT) points.

When the starting point is set, the  icon appears at the corresponding point beneath the playback position bar.

When the ending point is set, the  icon appears at the corresponding point beneath the playback position bar.

In divide mode, the loop starting/ icons disappear, and the  icon appears at the current position.

### ⑬ F1(⏻ / I) button function

This shows the function currently assigned to the F1(⏻ / I) button (YES).

I/O LOOP : Use to open the I/O LOOP SETTING pop-up to set IN/OUT points. (See "Looping playback" on page 71.)

### ⑭ File information display

Shows the name of the currently playing file.

#### NOTE

File names in Japanese and other languages that use multibyte encodings cannot be shown correctly.

### ⑮ F2 button function

This shows the function currently assigned to the F2 button.

DELETE : Use to open the FILE DELETE pop-up to confirm file deletion. (See "Deleting the selected file" on page 73.)

### ⑯ F3/HOME button function

This shows the function currently assigned to the F3/HOME button.

SPEED : Use to open the SPEED CONTROL pop-up where you can adjust the playback speed. (See "Setting the playback speed (method 1)" on page 72.)

### ■ Appearance during recording (audio/video)

The display appears as follows when in recording standby or recording.

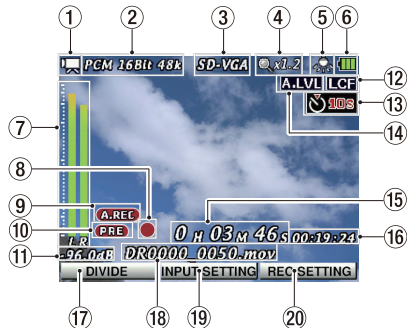

#### ① Operating mode

This icon shows the current operating mode.

: Video mode

: Audio mode

#### ② File format/sampling frequency used for recording

This shows the file format and sampling frequency used for recording (video/audio).

#### ③ Image resolution indicator

None	Audio mode, no captured still photo
0.3M	Audio mode with 640x480 captured still photo
0.9M	Audio mode with 1280x720 captured still photo
SD-VGA	Video mode at SD resolution
HD-720p	Video mode at HD resolution

#### ④ Digital zoom indicator

Shows the current digital zoom level. Nothing is shown when zoom is not in use.

Example:

: Current digital zoom magnification is 1.2 times normal

#### ⑤ White balance setting

The icon shows the current white balance setting. Power supply status

Icon	Setting	Description
	AUTO (default)	Adjusts automatically according to the situation
	BLUB LIGHT	Use for white bulb lighting
	FL LIGHT	Use for daytime white fluorescent lighting
	STAGE LIGHT	Use for stage and similar lighting
	SUNLIGHT	Use outdoors in clear weather
	CLOUDY	Use outdoors in cloudy weather

#### ⑥ Power supply status

This icon shows the power supply status. See “⑤ Power supply status” on page 19 for details.



#### ⑦ Level meters/peak indicators

When input monitoring is OFF, these show the playback volume level. When the file being played or recorded is stereo, two meters are shown with L (left) and R (right) labels below them. When the file is mono, only one meter is shown and it is labeled MONO.

## 2 – Names and Functions of Parts

### ⑧ Recorder operation indicator

This icon shows the recorder operation status.

-  : Recording (video/audio) standby
-  : Recording (video/audio)

### ⑨ Auto-record function status

The **A:REC** icon appears when auto-recording (video/audio) is ON and the unit is recording or in recording standby.

### ⑩ Pre-recording function status

The **PRE** icon appears when pre-recording (video/audio) is ON and the unit is recording or in recording standby.

### ⑪ Peak value in decibels (dB)

Shows the maximum recording input level in decibels at regular intervals.

### ⑫ Low cut filter function status

Shows whether or not a low cut filter is in use. A **LCF** icon appears when the filter is set to 40Hz, 80Hz or 120Hz.

### ⑬ Self-timer function status

Shows whether or not the self-timer is ON. An icon appears when ON.

No indicator : Self-timer function OFF

 : Self-timer function ON (set 2 seconds)

 : Self-timer function ON (set 10 seconds)

### ⑭ Level control function status

Shows whether or not level control or limiter is in use.

No indicator : Auto level control/limiter is OFF

**A.LVL** : Auto level control is ON

**LIMTR** : Limiter is ON

### ⑮ Elapsed time

Shows the elapsed time (hours: minutes: seconds) of the recording (video/audio).

### ⑯ Remaining recording (video/audio) time

Shows the remaining recording time (hours: minutes: seconds) on the loaded microSD card for the current recording format.

#### NOTE

The remaining time is an approximate estimate and differs from the actual available recording (video/audio) time. In particular, since the compression ratio changes depending on video recording conditions, recorded file sizes may vary greatly.

### ⑰ F1 (⏻ / |) button function

This shows the function currently assigned to the **F1 (⏻ / |)** button.

No indicator : In recording standby in video mode, the **F1 (⏻ / |)** button has no function.

DIVIDE : Divides the currently recording (video/audio) file. This appears only when recording.

CAPTURE : Captures a still photo. Saves a JPEG file with the same name as the audio recording file. This appears only when in audio mode recording standby.

### ⑱ File information display

Shows the name that will be automatically assigned to a recording file (video/audio).

#### NOTE

File names in Japanese and other languages that use multibyte encodings cannot be shown correctly.

### 19 F2 button function

This shows the function currently assigned to the **F2** button.  
**INPUT SETTING**: Use to open the **Input Setting** screen. (See “Preparing the recording inputs” on page 38.)

### 20 F3/HOME button function

This shows the function currently assigned to the **F3/HOME** button.  
**REC SETTING**: Use to open the **REC OPTION** screen.

#### NOTE

When in recording (video/audio) standby, **REC SETTING** appears above the **F3/HOME** button, but is not possible to change the **AUTO REC MODE** and **AUTO REC LEVEL** items from this screen.

To change these items, end recording (video/audio) standby and open the **Rec Option** screen.

## Photo mode

### ■ Appearance during playback and when stopped (Slide show)

Photos taken by the unit are shown in a slide show.



#### 1 Operating mode

This icon shows the current operating mode.

📷 : Photo mode

#### 2 Playback file image resolution

0.3M : 640 x 480

0.9M : 1280 x 720

#### 3 Playback area display

This shows the current playback area.

ALL : All files on the microSD card

FOLDER : All files in the selected folder (including files in sub-folders)

PLIST : All files added to the playlist

## 2 – Names and Functions of Parts

### ④ Playback file number/total number of files

This shows the current file number and the total number of files in the current playback area.

### ⑤ Power supply status

This icon shows the power supply status. See “⑤ Power supply status” on page 19 for details.

### ⑥ Photo mode slide show status

The  icon shows when a slide show is playing.

### ⑦ Self-timer function status

Shows whether or not the self-timer is ON. An icon appears when ON.

No indicator : Self-timer function OFF

 : Self-timer function ON (set 2 seconds)

 : Self-timer function ON (set 10 seconds)

### ⑧ F1(⏏ / |) button function

This shows the function currently assigned to the F1(⏏ / |) button.

SELF TIMER : Cycles through the self-timer settings.

→ OFF → 2Sec → 10Sec

### ⑨ File information

Shows the name of the current file shown.

#### NOTE

File names in Japanese and other languages that use multibyte encodings cannot be shown correctly.

### ⑩ F2 button function

This shows the function currently assigned to the F2 button.

DELETE : Use to open the FILE DELETE pop-up and confirm file deletion. (See “Deleting the selected file” on page 73.)

## ■ Appearance when ready to shoot

The image that the camera will capture is shown on the screen in real time.



### ① Operating mode

This icon shows the current operating mode.

 : Photo mode

### ② Still image resolution

0.3M : 640 x 480

0.9M : 1280 x 720



### ③ Digital zoom indicator







Shows the current digital zoom level. Nothing is shown when zoom is not in use.

Example:

: Current digital zoom magnification is 1.2 times normal

### ④ White balance setting

The icon shows the current white balance setting.

Icon	Setting	Description
	AUTO (default)	Adjusts automatically according to the situation
	BLUB LIGHT	Use for white bulb lighting
	FL LIGHT	Use for daytime white fluorescent lighting
	STAGE LIGHT	Use for stage and similar lighting
	SUNLIGHT	Use outdoors in clear weather
	CLOUDY	Use outdoors in cloudy weather

### ⑤ Power supply status

This icon shows the power supply status. See “⑤ Power supply status” on page 19 for details.

### ⑥ Self-timer function status

Shows whether or not the self-timer is ON. An icon appears when ON.

No indicator : Self-timer function OFF

 : Self-timer function ON (set 2 seconds)

 : Self-timer function ON (set 10 seconds)

### ⑦ F1(⏻ / |) button function

This shows the function currently assigned to the F1(⏻ / |) button.

SELF TIMER : Cycles through the self-timer settings.

→ OFF → 2Sec → 10Sec

## Menu structure

Press the **MENU** button to open the **MENU** screen.

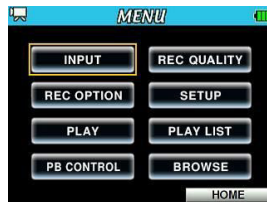

The menu contains the following items.

Menu item	Function	Reference
INPUT	Input settings	Page 38
REC OPTION	Recording (video/audio) mode settings	Page 46, 48, 49, 50
PLAY	Playback area, repeat playback and other settings	Page 62, 69, 70, 75
PB CONTROL	Playback speed change and other special playback	Page 72, 73
REC QUALITY	Recording (video/audio) quality settings	Page 36
SETUP	System settings	Page 31, 79, 81, 82, 83, 84
PLAYLIST	Playlist editing	Page 61, 65
BROWSE	microSD card file and folder operations	Page 56

## 2 – Names and Functions of Parts

### Using menus

The following example explains how to change the playback area.

1. Press the **MENU** button to open the **MENU** screen.

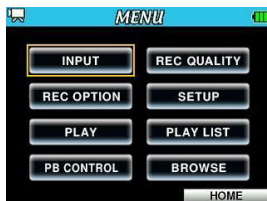

2. Use the Pointing Stick to select a menu item and press the center to open the selected settings screen. (The selected item has an orange frame.)



PLAY menu selected

3. Press **▲** and **▼** to select the item that you want to set. (The selected item has an orange background.)



PLAY AREA selected on the Play Option screen

4. Press **▶** or press the center of the Pointing Stick to open the setting options pop-up. (The current setting has an orange background.)

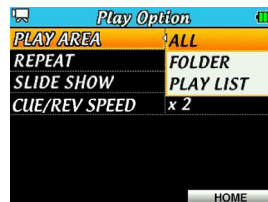



5. Press **▲** and **▼** to change the setting.



- To set another item on the same menu, press the center of the Pointing Stick to confirm the setting. Then, press ▲ and ▼ to move up and down and select a new item for setting. (The selected item has an orange background.)
- Repeat steps 3 to 6 as necessary to set other items.
- When a setting item is selected (orange background), press ◀ or press the **MENU** button to return to the **MENU** screen.  
Press the **F3/HOME** button to return to the Home Screen.

### NOTE

- On the **MENU** screen, press the **MENU** button to return to the Home Screen.
- The first time the **MENU** screen is opened, **INPUT** is selected (orange frame). The next time the **MENU** screen is opened, however, the last selected item will still be selected.
- The first time a setting screen is opened, the top item is selected (orange background). The next time the setting screen is opened, however, the last selected item will still be selected.
- When a setting selection pop-up is opened, the current value is selected (orange background).
- When more than 7 items are available,  and/or  appear indicating that there are hidden items in the direction of the arrow.

---

### Basic operation

---

Use the following buttons to operate the various setting screens.

#### **MENU** button

Opens the **MENU** screen.

#### **Operation mode** button

Changes the operation mode.

#### **F3/HOME** button

When a setting screen is open, press this button to return to the Home Screen.

Press this to answer [NO] to a confirmation message.

On the Home Screen, you can use it as the **F3/HOME** button.

#### **Pointing Stick**

On the **MENU** screen, press the center of the Pointing Stick to open the selected setting screen.

Press the center of the Pointing Stick to confirm the selection of a setting item.

Press ▶ to move right on a setting screen (current selection is orange) and to open a folder on the **BROWSE** screen.

Press ◀ to move left on a setting screen (current selection is orange) and to close a folder on the **BROWSE** screen.

On a menu setting item selection screen, press ◀ or the center of the Pointing Stick to open the setting screen.

On a setting screen, press the center or ◀ to return to the **MENU** screen. Press ▲ and ▼ to select an item (highlighted) or adjust a value.

On the Home Screen, press ▲ and ▼ to adjust the output level. (Press ▲ to raise the volume, and ▼ to lower it.)

## 2 – Names and Functions of Parts

### Function buttons (F1–F3)

Depending on the operating mode, different functions are assigned to these buttons.

Mode		F1	F2	F3
Video	Stopped Playback	I/O LOOP	DELETE	SPEED
	Recording standby	—	INPUT SETTING	REC SETTING
	Recording	DIVIDE		
Audio	Stopped Playback	I/O LOOP	DELETE	SPEED
	Recording standby	CAPTURE / RECAPTURE*	INPUT SETTING	REC SETTING
	Recording	DIVIDE	INPUT SETTING	REC SETTING
Photo	Stopped Playback	SELF TIMER	DELETE	—
	Recording standby	SELF TIMER	—	—
	Recording	—	—	—
Home Screen Pop-ups	I/O LOOP SETTING	IN	OUT	CLOSE
	FILE DELETE	YES	—	NO
	FORMAT	YES	—	NO
	INITIALIZE	YES	—	NO
	SPEED CONTROL	ON/OFF	—	CLOSE
Other screen	BROWSE	THUMBNAIL / FILE	PLAYLIST	HOME
	PLAYLIST	THUMBNAIL / FILE	BROWSE	HOME

\*Capture and recapture are only available in audio mode.

## Powering the unit

### Power supply options

Use three AA batteries or a TASCAM PS-P520 AC adapter (sold separately) to power the unit.

Either alkaline or Ni-MH batteries can be used.

### Using AA batteries

Open the battery compartment cover on the bottom of the unit. Insert three AA batteries oriented according to the  $\oplus/\ominus$  marks in the compartment, and close the battery compartment cover.

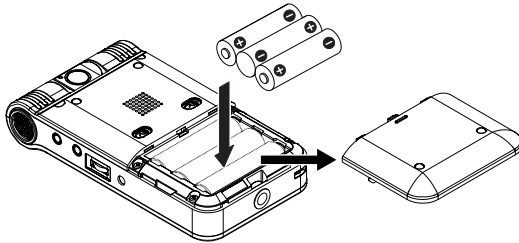

When using AA batteries, set the type of battery. This allows the unit to show the amount of power remaining accurately, and to determine whether enough power is available for proper operation. (See “Setting the battery type” on page 81.)

#### CAUTION

- Manganese dry cell batteries (R6) cannot be used with this unit.
- This unit cannot recharge Ni-MH batteries. Use a commercially available recharger.
- The included alkaline batteries are only for confirming the operation of the unit. For this reason, they may run out of charge quickly.

- Remove batteries from the compartment when not using the unit for long periods of time. Batteries left in the compartment might discharge gradually, rupture or leak fluid, which could result in damage to the unit.

### Using an AC adaptor (sold separately)

Connect a TASCAM PS-P520 AC adapter (sold separately) to the DC IN 5V jack as shown in the illustration.

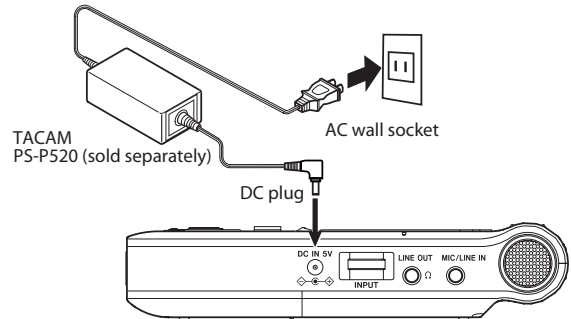

#### CAUTION

Never use any AC adapter other than the designated TASCAM PS-520 AC adapter. Use of a different adaptor could cause malfunction, fire or electric shock.

#### NOTE

When batteries are installed and the AC adaptor is connected, power will be supplied by the AC adaptor.

## 3 – Preparation

### Turning the power ON and OFF

#### CAUTION

Before turning this unit's power ON, turn the volume down all the way on any connected monitoring equipment. If you are wearing connected headphones, remove them before turning the power ON or OFF. Failure to do the above could result in noise that damages speakers and harms hearing.

#### Turning the power ON

When the unit is turned OFF, press and hold the **F1** (⏻ / I) button until the **PEAK** indicator right of the display lights.

"TASCAM DR-V1HD Startup..." appears while the unit starts up, and then the Home Screen opens.

The settings and the file last used are automatically loaded.



Start-up screen



Home Screen with file loaded

If there is no file, a message appears on the display, depending on the mode: "No Movie File" in video mode, "No Audio File" in audio mode, or "No Photo File" in photo mode.

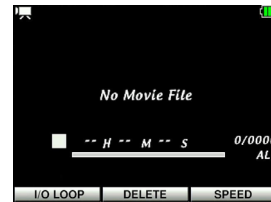

Home Screen without video file

#### NOTE

- The first time the power is turned ON, the Date/Time screen where you can set the date and time will open before the start-up screen. This also happens if the unit has been left without power for some time and the internal clock has reset. (See "Setting the date and time" on page 31.)
- If the power is turned ON when the remaining battery charge is very low, the unit might not start up properly and function incorrectly. If this occurs, install batteries that are new or have a sufficient charge and restart the recorder.

### Turning power off (standby)

To turn the unit off, press and hold the **F1**( $\phi$  / I) button until HD VIDEO LINEAR PCM RECORDER Shutdown... appears and then release the button. After the shutdown process completes, the unit turns off.



#### CAUTION

Always use the **F1**( $\phi$  / I) button to turn the unit OFF. Do not remove the batteries or disconnect the TASCAM PS-P520 AC adapter while the unit is operating. If you do so, all recordings (audio, video and photo), settings and other data will be lost. Data and settings that are lost cannot be recovered.

### Setting the date and time

This unit uses its internal clock to make a record of the date and time when a file (video/audio/photo) is recorded.

1. Press the **MENU** button to open the **MENU** screen.

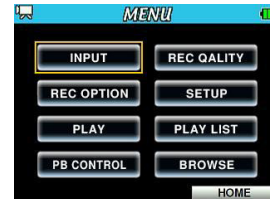



2. Use the Pointing Stick to select **SETUP** and press the center of the Pointing Stick to open the **Setup** screen.

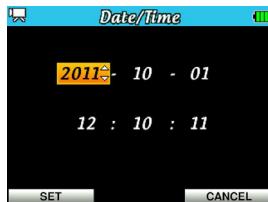

## 3 – Preparation

- Press ▲ and ▼ to select DATE/TIME and press ► to open the DATE/TIME Screen.



- Press ◀ and ▶ to move between units. Press ▲ and ▼ to change the values.
- Press the **F1**( / ) button (SET) to confirm the changes and return to the **SET.UF** screen. Press the **F3/HOME** button (CANCEL) to cancel the changes and return to the **SET.UF** screen.
- When done changing the setting, press the **F3/HOME** button to return to the Home Screen.

### NOTE

You can set the unit to automatically add this date and time to file names. (See “Setting the format of file names” on page 82.)

### CAUTION

The date and time setting is only retained for a few minutes if the unit is not powered by batteries or a TASCAM PS-P520 AC adaptor (sold separately). When using batteries, replace them before they completely lose power.

## Inserting and removing microSD cards

### Inserting the card

#### NOTE

A microSD card is already installed when the unit is shipped from the factory. If you want to use this microSD card to record and play video and audio and take and view photos, there is no need to reinstall it.

- Open the microSD slot cover on the left side panel of the unit.
- Insert the microSD Card into the slot as shown in the following illustration until it clicks into place.

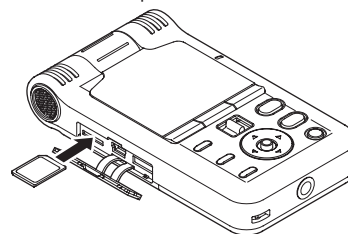



### Removing the card

1. Open the microSD slot cover on the right side panel.
2. Press the microSD card in gently and then release it to allow it to come out.

#### CAUTION

Do not remove the microSD card from the unit when it is connected to a computer via USB.

#### NOTES

- microSD cards that meet microSD or microSDHC standards can be used with this unit.
- A list of microSD cards that have been confirmed to work with this unit can be found on our website (<http://tascam.com/>).

### Preparing a microSD card for use

In order to use a microSD card with this unit, you must first format it with the unit.

#### CAUTION

Formatting deletes all the data on a card.

1. Confirm that a microSD card is inserted in the unit, and turn the power ON.
2. The following pop-up message appears when a new card or a card formatted for use with another device is installed in the unit.

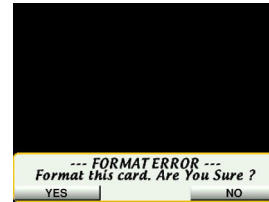

3. Press the **F1** (⏻ / |) button (Yes) to start formatting the card. Press the **F3/HOME** button (No) to cancel formatting. If you cancel formatting, you will need to remove the card and use a different one.
4. When formatting completes, the Home Screen will open.

#### CAUTION

When formatting a card, make sure the unit is powered by a TASCAM PS-P520 AC adapter (sold separately) or that the batteries have sufficient remaining power.

#### NOTE

You can format a card at any time. (See “Formatting” on page 83.)

## 3 – Preparation

### Using the built-in speaker

Set the **SPEAKER** switch on the bottom panel to ON to listen to playback with the built-in speaker.

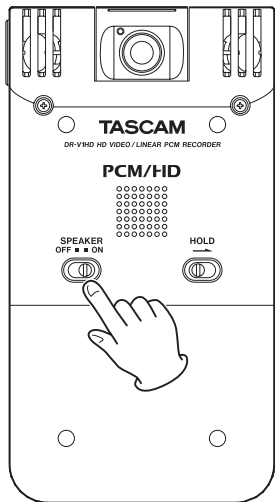

#### NOTE

When set to ON, sound will usually be output from the built-in speaker. In the following cases, however, sound will not be output even when set to ON.

- When recording and in recording standby (video/audio)
- When headphones or another device is connected to the  $\Omega$  /LINE OUT port

### Connecting monitors and headphones

To listen with headphones or an external monitoring system (powered monitor speakers or an amplifier and speakers), connect them to the  $\Omega$  /LINE OUT jack.

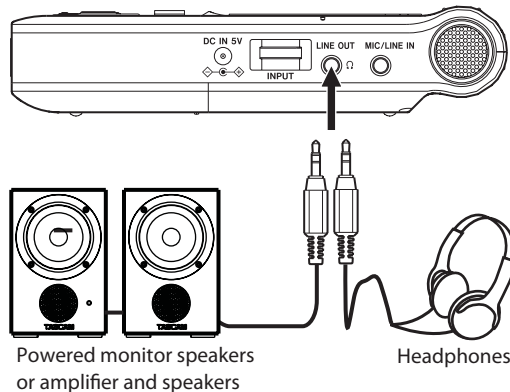

---

## Setting the operating mode

---

Set the operating mode that you want to use for recording or playback. To change the mode, press the operation mode button when the unit is stopped.



### Video mode

Use this mode for recording and playing video.

### Audio mode

Use this mode for recording and playing audio.

### Photo mode

Use this mode to take and view still photos.

#### NOTE

The unit remembers the selected operating mode and the last used mode will be active the unit is restarted.

## 4 – Video/Audio Recording

You can use the built-in camera to record video and the built-in microphone to record audio. In addition to using the built-in microphone, you can record using an external microphone or record audio output from a CD player or other external device.

The MOV format is the only video recording format supported. (Video with 96kHz audio is not supported.). You can set the image resolution to SD (640 x 480) or HD (1024 x 720).

The file format used for audio recording is WAV. You can set the sampling frequency to 44.1, 48 or 96 kHz and the bit rate to 16 or 24.

In addition, with this recorder, while playing back a recorded video file you can overwrite the playback sound with the input sound and record it as a new file (After Rec function).

### Setting the operating mode

Set the operating mode to either video or audio as appropriate. (See “Setting the operating mode” on page 35.)

Use Video mode to record video (with audio) or Audio mode to record audio only.

### Setting the audio file recording format, sampling frequency and video image resolution

Before you start recording (video/audio), select the recording file format.

1. Press the **MENU** button to open the **MENU** screen.
2. Use the Pointing Stick to select the **REC QUALITY** menu and press the center of the Pointing Stick to open the **REC QUALITY** screen.

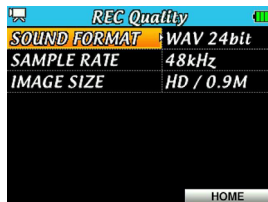

3. Press **▲** and **▼** to select **SOUND FORMAT**, and then press **▶** or the center of the Pointing Stick.  
Set the audio recording bit rate here.  
Press **▲** and **▼** to select one of the following.  
Options : WAV 16bit (default), WAV 24bit
4. Press the center of the Pointing Stick to confirm the setting change and return to the setting item list.
5. Press **▲** and **▼** to select **SAMPLE RATE**, and then press **▶** or the center of the Pointing Stick.

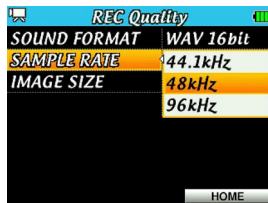

Set the sampling frequency here.

Press **▲** and **▼** to select one of the following.

Options : 44.1kHz (default), 48kHz, 96kHz.

#### CAUTION

In video recording mode, is not possible to record when set to 96kHz. An “Unsupported Sampling Rate!!” pop-up message will appear.

- Press the center of the Pointing Stick to confirm the setting change and return to the setting item list.
- Press ▲ and ▼ to select **IMAGE SIZE**, and then press ► or the center of the Pointing Stick.

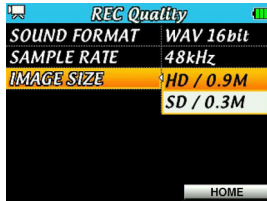

Set the screen resolution here.

Press ▲ and ▼ to select one of the following.

Options : HD/0.9M (default) and SD/0.3M.

- Press the center of the Pointing Stick to confirm the setting change and return to the setting item list.
- When setting is complete, press the **F3/HOME** button to return to the Home Screen.

### Available recording time indicator

The available recording (video/audio) time differs depending on the microSD card capacity, bit rate, sampling frequency and recording mode (video/audio). This shows the estimated recording time remaining on the microSD card. (See "Recording durations" on page 53.)



Available recording time on the microSD card

### Set where to save files

Select the folder where recorded files (video/audio) will be stored.

New recording files are stored in the folder set as the current folder. Set the current folder on the **BRIDGE** screen. (See "Folder operations" on page 60.) The default current folder is "MY\_FOLDER". If you do not change the default folder, newly recorded files will be saved in "MY\_FOLDER".

## 4 – Video/Audio Recording

### Preparing the recording inputs

1. Press the **MENU** button to open the **MENU** screen.
2. Use the Pointing Stick to select **INPUT**, and press the center to button to open the **Input Setting** screen.

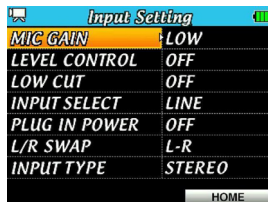

This screen contains the following setting items.  
Use the Pointing Stick to set each item.

#### MIC GAIN:

Set the microphone input sensitivity. When the input level is low, set to MID or HIGH.  
Options: LOW (default), MID, HIGH

#### LEVEL CONTROL:

When recording through the built-in microphone, you can use one of two level control functions.

Options: OFF (default), AUTO, LIMITER

When set to AUTO (automatic gain control mode), the unit's input gain changes automatically in response to the input level, so loud sounds are made quieter and soft sounds are made louder, making the recording level as even as possible. This is useful for recording meetings, for example.

When AUTO mode is active, the recording level cannot be adjusted manually.

When set to LIMITER (limiter mode) the unit's input gain is lowered automatically to prevent loud sounds from distorting. This is useful for

recording live performances and other situations when volume changes are extreme.

When LIMITER mode is active, the recording level can still be adjusted manually.

#### LOW CUT:

Set the low cut filter cutoff frequency for microphone input to avoid recording sounds such as air conditioner rumble, etc.

Options: OFF (default), 40Hz, 80Hz, 120Hz

#### INPUT SELECT:

Set whether the input source is a microphone (MIC) or line level signal (LINE). The default setting is MIC.

Regardless of the setting, the built-in microphone automatically becomes the input source when nothing is connected to the **MIC/LINE IN** stereo mini jack.

Set this to MIC to use an external microphone connected to the **MIC/LINE IN** stereo mini jack.

Set this to LINE to use a line level external device connected to the **MIC/LINE IN** stereo mini jack.

When set to LINE, the PLUG IN POWER item will automatically be disregarded.

### PLUG-IN POWER:

Set this to ON when connecting a microphone that requires plug-in power. Set this to OFF when using the built-in microphone.

Options: ON, OFF (default)

When the INPUT SELECT item is set to LINE, plug-in power will be disabled regardless of the PLUG IN POWER item setting. When set to MIC, the PLUG IN POWER item setting will be used.

### L/R SWAP:

Set to R-L to switch the left (L) and right (R) channels of the built-in microphone.

Options: L-R (default), R-L

### INPUT TYPE:

Set to STEREO or MONO according to the type of mic being used.

Options: STEREO (default), MONO

When set to MONO, both left and right channels receive the same input signal.

### NOTE

When in recording (video/audio) standby, you can also press the **F2** button (INPUT SETTING) to open the INPUT SETTING screen.

### CAUTIONS

- If the input signal is too loud, distortion might occur even when the LIMITER is ON. If this occurs, lower the recording level manually or move the recorder further from the sound source.
- When connecting a dynamic microphone or a microphone with a built-in battery, set PLUG-IN POWER to OFF. Leaving it ON might damage the microphone.
- Use headphones to monitor when you are recording with a microphone. If you use speakers to monitor, the sound output from the speakers might also be recorded, causing a poor recording or feedback.

### TIPS

- If air-conditioning, wind or other noises are being recorded, setting LOW CUT to a value other than OFF might reduce the noise.

- When recording a live performance or other situation when extremely loud signals might be input, set LEVEL CONTROL to LIMITER to prevent sound distortion due to sudden high levels.

## 4 – Video/Audio Recording

### Placement when recording with the built-in mic

Point the lens at the subject, and place the unit in a stable location where there is little vibration.

### Connecting an external mic or device

#### Recording with an external microphone (MIC IN)

Connect an external microphone to the **MIC/LINE IN** jack.

Point the unit's lens at the subject and the external microphone at the sound source, and place the unit and the microphone in a stable location where there is little vibration.

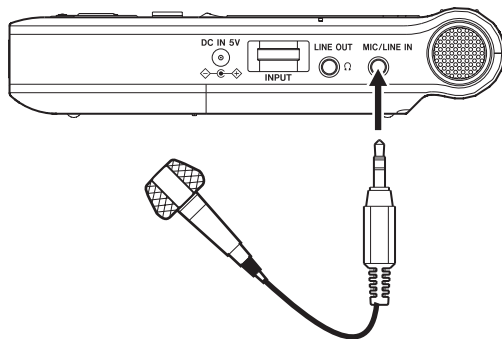

#### NOTE

Supported microphone types

- Dynamic mics
- Mics with built-in batteries
- Electret condenser mics that support plug in power



### Recording with an external device (LINE IN)

Use a stereo mini plug cable to connect the output of an external audio device to the **MIC/LINE IN** jack.

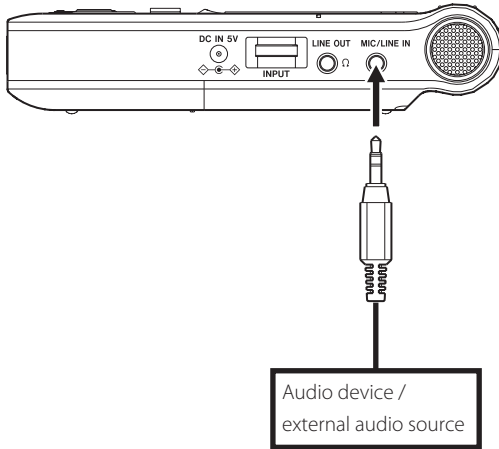

### Adjusting the input level

The following procedures explain how to adjust the input level.

1. Press the **RECORD** button to put the unit into recording standby (video/audio). The recording (video/audio) screen appears. The  icon shows the recording standby status.



2. Use the **INPUT** volume dial on the right side panel to adjust the input level.

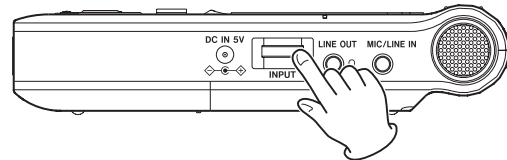

The **PEAK** indicator to the right of the display lights red just before the recording volume level becomes too high. Adjust the recording level so that the **PEAK** indicator light does not turn red.

## 4 – Video/Audio Recording

When using the built-in microphone or external microphone as the input source (INPUT SELECT set to MIC on the Input Setting screen), if the signal level is still low even when the input level is set to the maximum, set MIC GAIN on the Input Setting screen to a higher value. (See "Preparing the recording inputs" on page 38.)

### CAUTION

- Observe the following precautions when recording with a microphone:
- If MIC GAIN is set to MID or HIGH on the Input Setting screen, the sound being recorded might be distorted even if the **PEAK** indicator does not light.
- When adjusting the input level, first set MIC GAIN to LOW on the Input Setting screen and then adjust the INPUT volume dial. If a suitable input level is not achieved even if the INPUT volume dial is set to the maximum, set MIC GAIN to MID. If you still cannot achieve a suitable input level, set MIC GAIN to HIGH.
- If the input level is too high, the sound being recorded might be distorted even if the Limiter is ON. If this occurs, lower the **INPUT level** manually or move the mic further from the sound source.

### NOTE

- To exit recording standby (video/audio), press the **STOP/PAUSE** button.
- When INPUT SELECT is set to LINE on the Input Setting screen, the GAIN setting is disabled.
- When in recording standby or during recording (video/audio), no sound will be output from the speaker even if the **SPEAKER** switch is set to ON. If you want to monitor the input while adjusting the level or recording, connect headphones to the  / **LINE OUT** jack. You can adjust the monitoring volume by pressing **▲** and **▼** when the Home Screen is open. This does not affect the level of the recorded signal.

### TIPS

- In addition to adjusting the INPUT volume dial, try changing the distance and angle between the microphone and the sound source. The orientation and distance of the microphone relative to the sound source will change the character of the recorded sound.
- You can also use the auto gain control or limiter function to prevent distortion if the input signal becomes too high during recording. (See "Preparing the recording inputs" on page 38.)

### Recording (video/audio)

The following procedure describes how to set the input level after the input source is set and the Home Screen is already open.

1. Press the **RECORD** button to put the unit into recording standby (video/audio). On the recording (video/audio) screen, various information including the operation mode, recording file format and sampling frequency, image resolution and zoom level appear. So, you can check them before starting to record.

#### TIPS

- During recording standby in audio mode, you can take a photo (capture) that can be used as a background during recording and playback. (See “Capturing an image for audio file background” on page 50.)
- You can change the digital zoom magnification when shooting a movie. (See “Adjusting camera magnification” on page 44.)

2. Press the **RECORD** button again to start ordinary recording (video/audio).

When recording starts, the **REC** indicator lights, and the elapsed recording time and remaining recording time appear on the screen. In Video mode, the video that is being recorded also appears on the screen.

In Audio mode, the captured image (if there is one) appears on the screen. Otherwise, the image shown below appears on the screen.



3. To end recording, press the **STOP/PAUSE** button. To pause recording, press the **RECORD** button. Press the **RECORD** button again to restart recording in the same file. If you press the **STOP/PAUSE** button after pausing recording, a file with the video or audio recorded up to this point will be created.

## 4 – Video/Audio Recording

### Adjusting camera magnification

This unit's digital zoom allows you to zoom in on a subject before recording or taking a picture and during video recording.

When in recording standby or during recording, the digital zoom level is shown at the top right of the Home Screen.

You can adjust the zoom from 100%–400% (x1 to x4 in 0.1 increments).

To adjust the zoom, press the Zoom control towards **W** [◀◀] or **T** [▶▶].

#### **W** [◀◀]

Press the zoom control in this direction during recording or recording standby to decrease the zoom level and widen the field of view (W : wide).

#### **T** [▶▶]

Press the zoom control in this direction during recording or recording standby to increase the zoom level and narrow the field of view (T : telephoto).

### Overwriting recorded audio with the input signal (After Rec)

While playing back a recorded video file you can overwrite the playback sound with the input sound and record it as a new file (After Rec function).

#### **NOTE**

- After recording can only be used in the video recording mode.
- When using after recording, you cannot use the auto-recording function or start a new file manually.
- During after recording, sound will not be output from the built-in speaker even if the **SPEAKER** switch is set to ON.
- You cannot pause during after recording (the **RECORD** button is disabled).
- When using after recording, the sampling frequency of the playback file is used regardless of the current recording sampling frequency setting.

### Selecting the file to overwrite

Use ◀ and ▶ or the **BROWSE** screen to select the file.

#### **NOTE**

See “6 – Working with files and folders on the **BROWSE** screen” on page 56 for how to select a file on the **BROWSE** screen.

### Using the after recording function

1. Select the file that you want to After Record on the BROWSE screen.
2. Press the center of the Pointing Stick to open the pop-up menu and select After Rec.

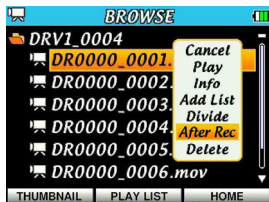

3. Press the center of the Pointing Stick again to put the recorder into recording (video/audio) standby.
4. Press the **RECORD** button to start after recording. When recording starts, the **REC** indicator lights, and the elapsed and remaining recording times appear on the Home Screen along with the name of the file being played back.

#### NOTE

The input monitoring sound will be heard a little after the actual sound.

5. When after recording completes for the selected file, the recorder will stop. (To play back the file that was created by after recording, you must select it by browsing.)

#### CAUTION

If the operation mode is not video recording mode, After Rec will not appear in the pop-up menu.

### Dividing a recording while continuing to record

You can manually divide a recording, saving the current file and continuing to record as a new file (video/audio).

Dividing also occurs automatically when the 2GB maximum file size is reached.

#### NOTE

If AUTO REC is set to FILE INC, dividing will also occur whenever recording is restarted. (See "Automatic recording functions (AUTO REC)" on page 46.)

### Manually starting a new file while recording

When recording (video/audio), press **F1** (**⏏** / **I**) button (DIVIDE) to divide the recording, saving the current file and continuing recording in a new file.

#### NOTE

When a new file is created, the number added at the end of the file name is increased by one.

#### CAUTION

- A new file cannot be created if the total number of files and folders would exceed 9999.
- A recording (video/audio) cannot be divided if the recording time of one of the new files would be shorter than two seconds.
- If the name of a newly created file would be the same as that of an existing file, the number added at the end of the file name is increased by one.
- When the file is divided manually, a little time is required to process it, so a gap of about 1 second will occur in sound and video recording. If you want to divide a file without creating gaps, record one continuous file and then divided it afterwards (see "Dividing a file (DIVIDE)" on page 51.).

## 4 – Video/Audio Recording

### Automatic recording division at maximum file size

If the maximum file size of 2GB is reached during recording, the recording is divided automatically, saving the current file and continuing to record as a new file.

#### CAUTION

- A new file cannot be created if the total number of files and folders would exceed 9999. If this happens, a "File Full" pop-up message appears on the screen and recording is stopped.
- When the file is divided manually, a little time is required to process it, so a gap of about 1 second will occur in sound and video recording.

#### TIP

The same file size could have different possible recording times, depending on the bit length, sampling frequency and resolution settings. If the recording length is 24 hours or more, it will be shown as 23:59:59.

### Automatic recording functions (AUTO REC)

You can set the unit to start, pause and divide recording (video/audio) automatically in response to the input volume level.

1. Press the **MENU** button to open the **MENU** screen.
2. Use the Pointing Stick to select **REC OPTION** and press the center of the Pointing Stick to open the **REC OPTION** screen.



3. Press **▲** and **▼** to select **AUTO REC MODE**, and then press **▶** or the center of the Pointing Stick.



4. Press ▲ and ▼ to set the auto-recording mode.

OFF (default)	Recording will not start/pause automatically.
PAUSE	Recording starts automatically when the AUTO REC LEVEL setting value is exceeded, and pauses automatically when the input signal falls below that level for more than five seconds. If the AUTO REC LEVEL is exceeded again, recording continues in the same file.
FILE INC	Recording starts automatically when the AUTO REC LEVEL setting value is exceeded, and pauses automatically when the input signal falls below that level for more than five seconds. If the AUTO REC LEVEL is exceeded again, recording continues in a new file.

5. Press the center of the Pointing Stick to confirm the setting change and return to the setting item list.
6. Press ▲ and ▼ to select AUTO REC LEVEL, and then press ► or the center of the Pointing Stick.

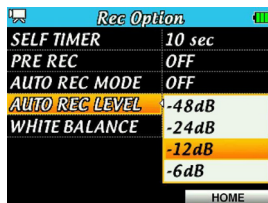

7. Press ▲ and ▼ to set the level used to determine when a signal has been input.  
 OPTIONS : -6dB, -12dB (default), -24dB, -48dB
8. When setting is complete, press the **F3/HOME** button to return to the Home Screen.
9. Press the **RECORD** button to put the unit into recording standby (video/audio). Recording starts automatically when the input signal exceeds the AUTO REC LEVEL setting.  
 Recording stops automatically when the input signal drops below the AUTO REC LEVEL for more than 5 seconds.  
 Recording restarts automatically when the input signal exceeds the AUTO REC LEVEL. Recording continues in the same file if the AUTO REC MODE is set to PAUSE. Recording is made to a new file if the AUTO REC MODE is set to FILE INC.
10. Press the **STOP/PAUSE** button to stop recording.

### NOTE

When in recording (video/audio) standby, REC SETTING appears above the **F3/HOME** button, but is not possible to change the AUTO REC MODE and AUTO REC LEVEL items from this screen.

To change these items, end recording (video/audio) standby and open the Rec Option screen.

## 4 – Video/Audio Recording

### Prerecording a few seconds before recording starts (PRE REC)

By using the prerecording function, when the unit is in recording standby (video/audio) you can automatically capture up to two seconds of the signal input before the recording starts.

1. Press the **MENU** button to open the MENU screen.
2. Use the Pointing Stick to select **REC OPTION** and press the center of the Pointing Stick to open the **REC OPTION** screen appears.
3. Press **▲** and **▼** to select **PRE REC**, and then press **▶** or the center of the Pointing Stick.



4. Press **▲** and **▼** to select **ON** (default: **OFF**).

5. When setting is complete, press the **F3/HOME** button to return to the Home Screen.

#### TIP

By using this in combination with the **AUTO REC** function, you can record events without losing the beginnings of sounds.

#### NOTE

If the unit has been in record standby for less than two seconds, sound for the amount of time in standby is recorded.



## Setting the white balance

You can set the white balance to suit the lighting conditions.

1. Press the **MENU** button to open the MENU screen.
2. Use the Pointing Stick to select the **REC OPTION** menu item, and press the center of the Pointing Stick to open the **REC Option** screen.
3. Press **▲** and **▼** to select the **WHITE BALANCE** item, and then press the center or **▶**.

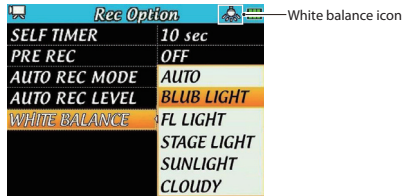

4. Press **▲** and **▼** to select one of the following settings.

Icon	Setting	Description
	AUTO (default)	Adjusts automatically according to the situation
	BLUB LIGHT	Use for white bulb lighting
	FL LIGHT	Use for daytime white fluorescent lighting
	STAGE LIGHT	Use for stage and similar lighting
	SUNLIGHT	Use outdoors in clear weather
	CLOUDY	Use outdoors in cloudy weather

The icon for the selected white balance setting appears at the top of the screen.

5. After completing the setting, press the **F3/HOME** button to open the Home Screen.

## 4 – Video/Audio Recording

### Using the self-timer to delay recording

Use the self-timer to start recording a set amount of time after the **RECORD** button is pressed.

1. Press the **MENU** button to open the **MENU** screen.
2. Use the Pointing Stick to select (highlight) **REC OPTION** and press the center of the Pointing Stick to open the **REC OPTION** screen.
3. Press **▲** and **▼** to select **SELF TIMER**, and then press **▶** or the center of the Pointing Stick.



4. Press **▲** and **▼** to change the setting and then press the center of the Pointing Stick.  
Options: OFF (default), 2 sec, 10 sec.
5. When done changing the setting, press the **F3/HOME** button to return to the Home Screen.

### Capturing an image for audio file background

In audio mode, you can take (capture) a still photo when in recording standby and use it as a background during recording/playback.

1. Press the **RECORD** button to put the unit into recording standby.



2. Focus the camera so that the image you want to shoot appears on screen.
3. Press the **F1(⏏ / I)** button (CAPTURE) to take the still photo.  
The image captured is saved as a JPEG file with the same name of the next audio file to be recorded, but with a ".jpg" extension.
4. The captured image is set as the Home Screen background.
5. You can press the **F1(⏏ / I)** button (RECAPTURE) again to capture a different image, if you want. The previously captured image is overwritten.

#### NOTE

When the **BROWSE** screen is in thumbnail display mode, this image is also used as the thumbnail.

## Dividing a file (DIVIDE)

A recorded file can be divided into two at a specified position.

### NOTE

The SD card must have at least as much open space as the file being divided. If there is not enough open space, an “Out of Card Space” pop-up message appears. If this occurs, change the media or delete unnecessary files to increase the amount of open space.

1. Press the **MENU** button to open the **MENU** screen.
2. Use the Pointing Stick to select **BROWSE** and press the center of the Pointing Stick to open the **BROWSE** screen.

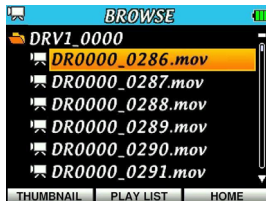

3. Press **▲** and **▼** to select the file you want to divide.

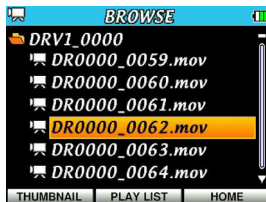

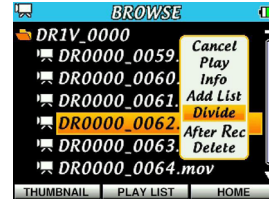

4. Press **▲** and **▼** to select **DIVIDE**.



5. Press the center of the Pointing Stick to enter divide mode. The  icon appears on the Home Screen, and the selected file plays back.



Press the **F1** ( / ) button (**DIVIDE**) at the position where you want to divide the file, or press the **F3/HOME** button (**CANCEL**). The file will play back repeatedly until you press one of these buttons.

## 4 – Video/Audio Recording

6. Press the **F1**( $\phi$  / I) button (DIVIDE) to open a confirmation pop-up.



7. Press the **F1**( $\phi$  / I) button (YES) again to divide the file, or press the **F3**/ **HOME** button (NO) to cancel division. The  icon disappears from the Home Screen.

### NOTE

- In Divide mode, you can use the zoom control (W [◀◀] / T [▶▶]), **PLAY** and **STOP/PAUSE** buttons to quickly search for the position where you want to divide the file.
- After dividing a file, two new files with `_a` or `_b` added to the end of the original file name are created. After being divided, the original file is not automatically deleted.

Example:

#### File name before dividing

DR0000\_0000.wav

#### File names after dividing

DR0000\_0000\_a.wav (part before division point)

DR0000\_0000\_b.wav (part after division point)

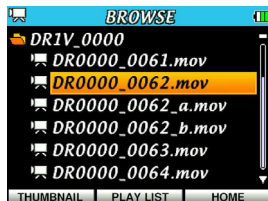

### CAUTION

- The card must have at least as much open space as the file that is divided.
- Division is not possible if the file name would become more than 200 characters long.
- Division is not possible if an existing file has the same name as the name that would be given to a new file created by division.

### Recording durations

The table below shows maximum recording times in hours and minutes on microSD/microSDHC cards of different capacities for different recording bit rates and sampling frequencies.

Operating mode	File recording format settings		microSD/microSDHC card capacity				
			2GB	4GB	8GB	16GB	32GB
Video mode	16bit SD-VGA (STEREO)	44.1kHz	1:01	2:00	4:01	8:03	16:07
		48kHz	0:58	1:57	3:55	7:50	15:40
	24bit SD-VGA (STEREO)	44.1kHz	0:52	1:44	3:28	6:56	13:53
		48kHz	0:50	1:40	3:21	6:42	13:24
	16bit HD-720p (STEREO)	44.1kHz	0:28	0:56	1:53	3:46	7:33
		48kHz	0:28	0:55	1:51	3:43	7:27
	24bit HD-720p (STEREO)	44.1kHz	0:26	0:52	1:45	3:30	7:01
		48kHz	0:25	0:51	1:43	3:27	6:54
Audio mode	16-bit WAV (STEREO)	44.1kHz	3:09	6:13	12:35	25:11	50:23
		48kHz	2:53	5:47	11:34	23:08	46:17
		96 kHz	1:26	2:53	5:47	11:34	23:08
	24-bit WAV (STEREO)	44.1kHz	2:06	4:12	8:23	16:47	33:35
		48kHz	1:55	3:51	7:43	15:25	30:51
		96 kHz	0:57	1:55	3:51	7:43	15:25

- The recording times shown above are estimates. These values may differ depending on the microSD/microSDHC card used.
- The recording times shown above are not continuous recording times, but rather they are the total possible recording times for the microSD/microSDHC card.

# 5 – Taking still photos

In addition to using the built-in camera to record video and the built-in microphone to record audio, you can also take still photos with this unit.

The file format used for still images is JPEG, and the resolution can be set to 0.9M (1280 x 720) or 0.3M (640 x 480).

## Setting the operation mode

Set the operation mode to photo mode to take still photos. (See “Setting the operating mode” on page 35.)

## Setting the image size

Set the image size (resolution) before taking still photos.

1. Press the **MENU** button to open the **MENU** screen.
2. Use the Pointing Stick to select **REC QUALITY** and press the center of the Pointing Stick to open the **REC QUALITY** screen.
3. Press **▲** and **▼** to select **IMAGE SIZE** and press **▶** or the center of the Pointing Stick.

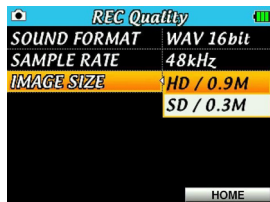

4. Press **▲** and **▼** to select one of the following size options.  
Options : HD/0.9M (default), SD/0.3M.
5. When setting is complete, press the **F3/HOME** button to return to the Home Screen.

## Set where to save photo files

Select the folder where photo files will be stored.

New photo files are stored in the folder set as the current folder. Set the current folder on the **BROWSE** screen. (See “Folder operations” on page 60.)

The default current folder is “MY\_FOLDER”. If you do not change the default folder, newly recorded files will be saved in “MY\_FOLDER”. Only first level folders can be designated.

### Using the zoom in photo mode

This unit's digital zoom allows you to zoom in on a subject before taking a picture.

The digital zoom level is shown at the top right of the Home Screen.

You can adjust the zoom from 100%–400% (×1 to ×4 in 0.1 increments).

Press the zoom control towards **W** [◀◀] to zoom out or **T** [▶▶] to zoom in.

#### **W** [◀◀]

Press the zoom control in this direction during recording or recording standby to decrease the zoom level and widen the field of view (W : wide).

#### **T** [▶▶]

Press the zoom control in this direction during recording or recording standby to increase the zoom level and narrow the field of view (T : telephoto).

### Using the self-timer in photo mode

Use the self-timer to take a photo a set amount of time after pressing the **RECORD** button. This function works the same way as the self-timer of an ordinary film or digital camera.

On the Home Screen, press the **F1** (⏻ / |) button to cycle through the self-timer settings.



#### **NOTE**

You can also set the self-timer with the Self Timer item on the **REC OPTION** screen.

### Taking photos

The procedure below assumes that photo mode is active and the Home Screen is open.

1. Press the **RECORD** or **STOP/PAUSE** button to put the unit into photo standby.  
The image that the camera will capture is shown on the screen in real time.  
In addition to the photo mode status, the image resolution, digital zoom level (when zoom in use), white balance mode and current power supply status are shown on screen.  
At this time, you can use the zoom control to adjust the digital zoom.
2. Press the **RECORD** button to take a still photo.  
For 2 seconds after being taken, the photo is shown without any information indications.
3. Press the **STOP/PAUSE** button to exit photo standby.

## 6 – Working with files and folders on the BROWSE screen

Use the **BROWSE** screen to view the contents (including video, audio and photo files) and delete files, create folders and add files to a playlist. (See “Playlist” on page 65.)

### TIP

You can also edit the contents of **MY\_FOLDER**, including deleting files, by accessing the microSD card from a computer. Do this by either connecting the unit to a computer by USB or by loading the microSD card on the computer using a card reader other means. You can also edit file names from a computer.

### NOTE

File names in Japanese and other languages that use multibyte encodings cannot be shown correctly.

To open the **BROWSE** screen, press the **MENU** button to open the **MENU** screen. Then, use the Pointing Stick to select **BROWSE** and press the center of the Pointing Stick. When the **BROWSE** screen opens in thumbnail mode, it appears as follows.

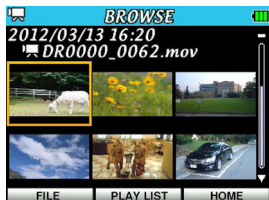

On the **BROWSE** screen, the file that was selected on the Home Screen remains selected and the contents of the folder that contains it are shown.

### NOTE

Press and hold the **PLAY** button when stopped, paused or playing back to return to the last screen — **BROWSE** or **PLAY LIST**.

### Setting the operation mode before using the BROWSE screen

File operations can only be conducted on files that match the current mode (and the folders that contain them). Set the mode for the type of files that you want to work with beforehand. (See “Setting the operating mode” on page 35.)

### Navigating the BROWSE screen

In addition to the thumbnail mode, the **BROWSE** screen has a file list mode that shows folders and video, audio and photo files in a hierarchical structure similar to how they would appear on a computer.

Press the **F1** (⏏ / I) button (**THUMBNAIL**) to switch between **FILE** and **THUMBNAIL** modes. The selected mode is retained and will be used the next time the **BROWSE** Screen is opened.

One level of subfolders can be made and used.

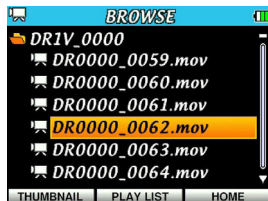



## 6 – Working with files and folders on the BROWSE screen

Select the desired audio file on the BROWSE screen and press the center of the Pointing Stick to open the pop-up window shown below.

- Press ▲ and ▼ to select the desired file or folder.
- When a folder is selected, press ► to open the folder and see its contents.
- When a file or folder is selected, press ◀ to close the currently open folder and view the root folder contents.
- While a folder or file is selected, press the center of the Pointing Stick to open a pop-up menu.

---

### BROWSE screen contents

---

The contents of each display mode are explained in the following sections.

#### Thumbnail display mode

The following items are shown in thumbnail display mode.

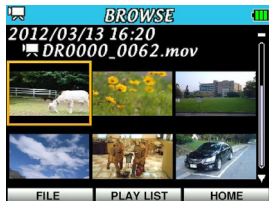

#### Operation mode

The icon at the upper left corner shows the current operation mode.

#### Recording starting time

The recording date/time of the currently selected file (starting time for video or audio) is shown in yyyy/mm/dd hh:mm format.

#### File name

The name of the currently selected file is shown with an icon for the file type before it.

#### File thumbnails

File thumbnails are shown according to the mode.

##### Video mode

Playable video files (with .mov extension) are shown. The thumbnail is a still image from 30 seconds after the playback starting point. If a file is less than 30 seconds, the final image is displayed as the thumbnail. To maintain a consistent thumbnail size, black bars are displayed at the tops and bottoms of thumbnails used for HD videos.

##### Audio mode

Only audio files with the .wav extension are shown. If the CAPTURE function was used before recording, the JPEG file with the same name is shown; otherwise, the 📄 icon is shown.

##### Photo mode

Still image files with the .jpg extension are shown.

## 6 – Working with files and folders on the BROWSE screen

### List mode

In FILE list mode, file and folder names are shown with icons.

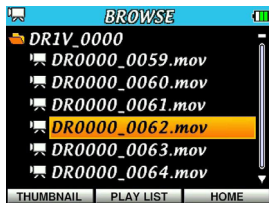

### Operation mode

The icon at the upper left corner shows the current operation mode.

### Folder name

The name of the currently open folder is shown at the top of the list with a folder icon.

### File name list

The names of the files in the currently open folder are shown in a list. The currently selected file is shown with an orange background. The icons next to the file names show the file type.

### Icons shown in list view

The icons shown mean the following.



#### Video file

This icon, which is shown only in video mode, appears before the names of video files.

Only playable video files that have the .mov extension are shown.



#### Audio file

This icon, which is shown only in audio mode, appears before the names of audio files.

Only audio files with .wav extension are shown.



#### Photo file

This icon, which is shown only in photo mode, appears before the names of photo files.

Only still image files with the .jpg extension are shown.



#### folder

This icon appears next to folders created inside "MY\_FOLDER" on the microSD card.



#### Open folder

This icon appears before the name of the folder that is open. The contents of this folder are shown on this screen.

## 6 – Working with files and folders on the BROWSE screen

### File operations

Select (highlight) the desired file on the **BROWSE** screen and press the center of the Pointing Stick to open a pop-up menu, as shown below.

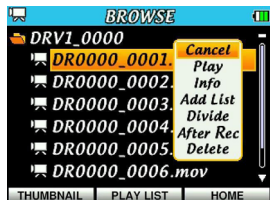

Press ▲ and ▼ to select the desired menu item and press the center of the Pointing Stick to use that function.

#### Cancel

Do nothing with the selected file and close the pop-up menu.

#### Play

Return to the Home Screen and play back the file. If the playback area is set to **FOLDER**, the folder that contains this file becomes the playback area.

#### Info

Open a pop-up that shows information (name, format, size, time and date) about the selected file. Press the **F3/HOME** button (close) to return to the **BROWSE** screen.

#### Add List

Add the selected file to a playlist. (See "Playlist" on page 65.)

#### Divide

Enter divide mode in which you can split the selected file into two. (See "Dividing a file (DIVIDE)" on page 51.)  
Photos cannot be divided.

#### After Rec

Put the recorder into recording standby so the audio of the selected video file can be overwritten.

After Rec can only be used with video files.

#### Delete

Open a pop-up confirmation, and press the **F1(⏏ / I)** button (YES) to delete the selected file or the **F3/HOME** button (NO) to cancel deletion.

#### NOTE

If a deleted file had been added to a playlist, it will also be removed from the playlist.

## 6 – Working with files and folders on the BROWSE screen

### Folder operations

Select the desired folder on the **BROWSE** screen and press the center of the Pointing Stick to open the pop-up window shown below.

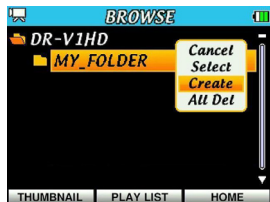

Press **▲** and **▼** to select the desired menu item and press the center of the Pointing Stick to use that function.

#### Cancel

Do nothing with the selected folder and close the pop-up menu.

#### Select

Make the selected folder the current folder and return to the Home Screen. The first file in the folder is selected. Regardless of the previous playback area setting, this folder becomes the new playback area. New recording files (video and audio) will also be stored in this folder.

#### Create

A pop-up message appears to confirm the creation of a new folder.

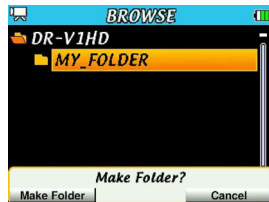

Press the **F1** (**⏏** / **I**) button (Make Folder) to create a folder, or press the **F3**/**HOME** button (Cancel) to cancel creation.

#### All Del

A pop-up message appears to confirm that you want to delete all the files in the selected folder. Press the **F1** (**⏏** / **I**) button (Delete) to delete the file, or press the **F3**/**HOME** button (Cancel) to cancel deletion.

#### NOTE

Files that have been locked using a computer, as well as files and subfolders that this unit cannot recognize cannot be deleted.

# 7 – Video and Audio Playback

On the Home Screen, press ◀ or ▶ to select the song (file) you want play back. The files that you can select are determined by the playback area setting. Limiting the play-back area makes file selection easier when, for example, you have numerous files on a card.

On the PLAY AREA screen, you can select all files (ALL), the current folder (FOLDER) or a playlist (PLAY LIST) as the play-back area. You can also use the BROWSE Screen to set a folder as the playback area.

## NOTE

On the BROWSE Screen, regardless of the play-back area setting, you can select any file on the card.

## Setting the operation mode for playback

Only files that correspond to the active operation mode can be played back. (See “Setting the operating mode” on page 35.)

Use video mode to playback video files or audio mode to playback audio files.

## Adjusting playback volume

On the Home Screen, press ▲ and ▼ to adjust the output level from the built-in speaker and ◻/LINE OUT jack.

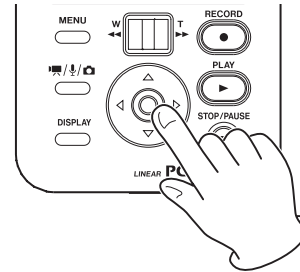

At this time, a volume level pop-up window appears.

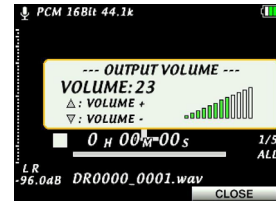

The pop-up on the Home Screen closes automatically after a few seconds, but you can also press the F3/HOME button to close the pop-up immediately.

## 7 – Video and Audio Playback

### Setting the playback area

Use the **PLAY AREA** item on the **Play Option** screen to set the playback area.

1. Press the **MENU** button to open the **MENU** screen.
2. Use the Pointing Stick to select the **PLAY** menu item and then press the center of the Pointing Stick to open the **Play Option** screen.



3. Press **▲** and **▼** to select **PLAY AREA** and press **▶** or the center of the Pointing Stick.



4. Press **▲** and **▼** to set the playback area.

#### **ALL (Default)**

Play back all the files in the **MY\_FOLDER** folder on the microSD card.

#### **FOLDER**

Play back all the files in the folder of the currently selected file.

#### **PLAY LIST**

Play back the files in the playlist. (See "Playlist" on page 65.)

If you select this and there is no playlist, the **No PLAYLIST** pop-up appears.

5. After you have made the setting, press the **F3/HOME** button to return to the Home Screen.

#### **NOTE**

The current playback area setting appears at the bottom right of the Home Screen.



## Setting a folder as the playback area on the BROWSE screen (method 1)

Regardless of the current playback area, if you select a folder on the BROWSE Screen, the selected folder becomes the playback area.

1. Press the **MENU** button to open the MENU screen.
2. Use the Pointing Stick to select the **BROWSE** menu item and then press the center of the Pointing Stick to open the BROWSE screen.



3. Press **▲** and **▼** to select the folder you want to set as the playback area. For an explanation of how to use the BROWSE Screen, see "Navigating the BROWSE screen" on page 56.

4. Press the center of the Pointing Stick to open the following pop-up window.

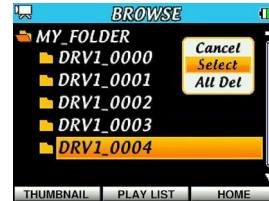

Press **▲** and **▼** to highlight **Select** and press the center of the Pointing Stick.

The Home Screen reopens and the first file in the folder is selected. Regardless of the previous playback area setting, this folder becomes the new playback area.

## 7 – Video and Audio Playback

### Setting a folder as the playback area on the BROWSE screen (method 2)

When the playback area is set to FOLDER, if you select a file on the BROWSE screen, the folder that contains the selected file becomes the playback area.

1. Press the **MENU** button to open the **MENU** screen.
2. Use the Pointing Stick to select the **BROWSE** menu item and then press the center of the Pointing Stick to open the **BROWSE** screen.

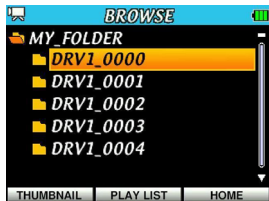

3. Press **▲** and **▼** to then select the folder that contains a video or audio file you want to play back.  
For an explanation of how to use the **BROWSE** Screen, see "Navigating the **BROWSE** screen" on page 56.
4. Press **▶**.
5. Select a file you want to play back.

6. Press the center of the Pointing Stick to open the following pop-up window.

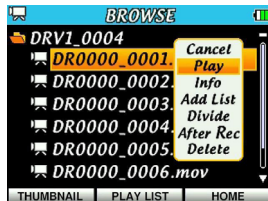

Press **▲** and **▼** to select **Play** and press the center of the Pointing Stick. The Home Screen reopens and the selected file starts playing. If the playback area is set to **FOLDER**, the folder that contains the selected file becomes the playback area.



## Playlist

You can make a playlist of files for playback.

Set the **PLAY AREA** item to **PLAY LIST** on the **Play Option** screen to play back the songs in a playlist.

There is one playlist for each operation mode, and you can make, edit and use these independently.

Playlists can be viewed in either of two modes: **THUMBNAIL** that shows an image for each file and **FILE** that shows a list of icons and file names.

### Thumbnail display mode (default):

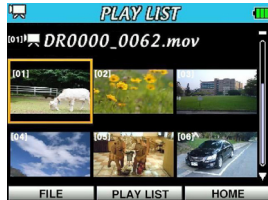

#### Operation mode

The icon at the upper left corner shows the current operation mode.

#### List numerical order

The order of each file in the list is shown in brackets.

#### File name

The name of the currently selected file is shown with an icon for the file type before it.

#### File thumbnails

File thumbnails are shown.

### List display mode

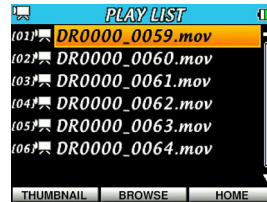

#### Operation mode

The icon at the upper left corner shows the current operation mode.

#### List numerical order

The order of each file in the list is shown in brackets.

#### File name list

The names of the files in the current playlist are shown in a list. The currently selected file is shown with an orange background. Icons that show the file type are shown next to the file names.

#### NOTE

- For explanations of the icons shown, see "Icons shown in list view" on page 58.
- File names in Japanese and other languages that use multibyte encodings cannot be shown correctly.

## 7 – Video and Audio Playback

### Adding files to a playlist

1. Press the **MENU** button to open the **MENU** screen.
2. Use the Pointing Stick to select the **BROWSE** menu item and then press the center of the Pointing Stick to open the **BROWSE** screen.

#### NOTE

For an explanation of how to use the **BROWSE** Screen, see “6 – Working with files and folders on the **BROWSE** screen” on page 56.

3. Press **▲** and **▼** to select the file you want to add to a playlist and press the center of the Pointing Stick to open a pop-up window.

#### NOTE

For details about how to select the file, see “Navigating the **BROWSE** screen” on page 56.

4. Use the Pointing Stick to select Add List.

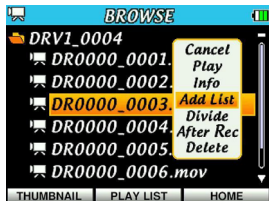

5. Press the center of the Pointing Stick to add the selected file to the playlist and close the pop-up window.
6. Repeat steps 3–5 as necessary to add more files to the playlist. The files are numbered in the order that they are added.

### Editing a playlist

View the playlist you have made on the **PLAYLIST** screen. Use this screen also to play back files and edit the playlist.

1. Press the **MENU** button to open the **MENU** screen.
2. Use the Pointing Stick to select the **PLAYLIST** menu item and then press the center of the Pointing Stick to open the **PLAYLIST** screen.

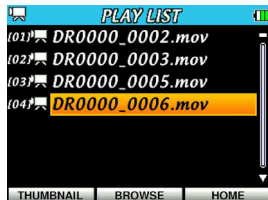

- Press ▲ and ▼ to select the file you want to edit and press the center of the Pointing Stick to open a pop-up menu.

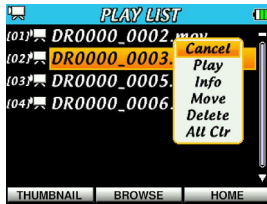

- Press ▲ and ▼ to select the desired menu item and press the center of the Pointing Stick to use that function.

#### Cancel

Do nothing with the selected file and close the pop-up menu.

#### Play

Return to the Home Screen and play back the file.

#### Info

Open a pop-up that shows information (name, format, size, time and date) about the selected file. Press the **F3/HOME** button (Close) to return to the **PLAYLIST** screen.

#### Move

Change the order of files in a playlist. Along with the file name, the playlist order number will also appear highlighted.

- Press ▲ and ▼ to move the selected file in the playlist.

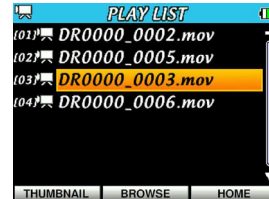

In the above illustration, the 2nd file has been moved to the 3rd place.

- Press the center of the Pointing Stick to confirm the change and end Move mode.

#### Delete

Remove the selected file from the playlist. The removed file is not deleted from the microSD card.

#### All Ctr

Open a confirmation message to confirm that you want to remove all the files from the playlist. Press the **F1(⏏)** button (YES) to clear the playlist, or press the **F3/HOME** button (NO) to cancel.

For this operation, it does not matter which file you select in step 3. All the files are removed from the playlist, but they are not deleted from the microSD card.

## 7 – Video and Audio Playback



---

### Skipping to select files for playback

---

On the Home Screen, use ◀ and ▶ to skip to the file you want to play back. Press ◀ when in the middle of a file to skip to the beginning of that file. Press ◀ when at the beginning of a file to skip to the beginning of the previous file. At the beginning or middle of a file, press ▶ to skip to the beginning of the next file.

#### NOTES

- Only files in the playback area can be played.
- The track name, file number and other file information for the currently playing file appear on the display.
- The  icon appears on the display when playback is stopped at the beginning of a file, and the  icon appears when playback is paused in the middle of a file.

---

### Playback

---

When the Home Screen is open, press the **PLAY** button when playback is stopped to start playback.

#### NOTES

- Only files of the type that suits the current operation mode in the playback area can be selected and played.
- You can also choose any file of the type that suits the current operation mode for playback by name on the **BROWSE** screen.
- This recorder can only play mov files that it created.

---

### Pausing and stopping playback

---

When the Home Screen is open, press the **STOP/PAUSE** button to pause playback at the current position.

Press the **STOP/PAUSE** button again to stop playback and return to the beginning of the file.

When playback is paused, press the **PLAY** button to restart playback from the current position.

## Searching backward and forward

On the Home Screen, press the zoom control left or right (**W** [◀◀] or **T** [▶▶]) while a file is playing back, paused or stopped to search backward or forward.

No sound is output when rewinding or fast-forwarding.

### Press briefly toward **W** [◀◀]

Search backward to the beginning of the file where it will stop.  
Press **W** [◀◀] again to change the search speed.

### Press briefly toward **T** [▶▶]

Search forward to the beginning of the next file where it will stop.  
Press **T** [▶▶] again to change the search speed.

### Press and held toward **W** [◀◀]

Search backward for as long as you keep pressing (searching does not stop at the file beginning). Playback resumes at the point when you stop pressing.

### Press and held toward **T** [▶▶]

Search forward for as long as you keep pressing (searching does not stop at the file end). Playback resumes at the point when you stop pressing.

## Search speed adjustment

The search speed can be changed as follows.

	Status before searching starts	
	Stopped/Paused	Playing back
Press <b>W</b> [◀◀] or <b>T</b> [▶▶] repeatedly	×10 → ×100 → ×1000	×5 → ×10 → ×50
Press and hold	Fixed at ×10	Depends on CUE/REV SPEED setting

## 7 – Video and Audio Playback

### Setting the search speed

Use the **CUE/REV SPEED** item on the **Play Option** screen to set the backward/forward search speed when the zoom control is pressed and held during playback.

1. Press the **MENU** button to open the **MENU** screen.
2. Use the Pointing Stick to select the **PLAY** menu item and then press the center of the Pointing Stick to open the **Play Option** screen.



3. Press **▲** and **▼** to select **CUE/REV SPEED** and press **▶** or the center of the Pointing Stick.





4. Press **▲** and **▼** to change the search speed setting.  
Options: x2 (double speed, default) to x10 (in increments of 1)
5. When done changing the setting, press the **F3/HOME** button to return to the Home Screen.

### Repeat playback (REPEAT)

You can repeatedly play back one file or multiple files within the designated playback area.

1. Press the **MENU** button to open the **MENU** screen.
2. Use the Pointing Stick to select the **PLAY** menu item and then press the center of the Pointing Stick to open the **Play Option** screen.
3. Press **▲** and **▼** to select **REPEAT** and press **▶** or the center of the Pointing Stick.
4. Press **▲** and **▼** to set the repeat mode.



OFF (default)	All files in the playback area are played in sequence one time. (This is the ordinary playback mode.)
ON	All songs in the selected playback area are played back in order repeatedly. The  icon appears on the Home Screen.
SINGLE	One song is played back repeatedly. The  icon appears on the Home Screen.

5. When done changing the setting, press the **F3/HOME** button to return to the Home Screen.

## Looping playback

Using the I/O LOOP function, you can continuously repeat (loop) playback of a section between IN and OUT points that you set.

1. On the Home Screen, during playback or when playback is stopped or paused, press the **F1**(**⏮** / **I**) button (I/O LOOP) to open the I/O LOOP SETTING pop-up.

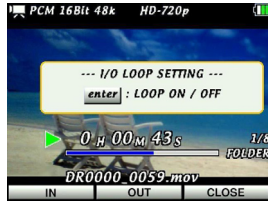

If stopped or paused, press **PLAY** button to start playback.

2. Press the **F1**(**⏮** / **I**) button (IN) to set the current point as the starting (IN) point of the section to be played repeatedly. The **I** mark appears under the playback position bar to show the location of the start (IN) point.
3. Press the **F2** button (OUT) to set the current point as the end (OUT) point of the section to be played repeatedly. The **O** mark appears under the playback position bar to show the location of the OUT point.

4. Press the center of the Pointing Stick to turn I/O LOOP playback ON. The **I/O** icon appears on the Home Screen during loop playback.



Press the center of the Pointing Stick again to turn I/O LOOP playback OFF. The **I/O** icon disappears from the Home Screen when OFF.

5. Press the **F3/HOME** button (CLOSE) to close the loop playback pop-up.

### NOTES

- To cancel I/O LOOP playback, press the **F1**(**⏮** / **I**) button (I/O LOOP) to open the I/O LOOP SETTING pop-up, and press the center of the Pointing Stick to turn IN-OUT looped playback OFF. The **I/O** icon will disappear.
- The IN (starting) and OUT (ending) points cannot be set in different files.

## 7 – Video and Audio Playback

### Using VSA playback

This recorder includes a Variable Speed Audition (VSA) function that allows you to change the playback speed without changing the pitch. You can use the VSA function to make practicing and learning musical phrases easier.

### Setting the playback speed (method 1)

Press the **F3/HOME** button on the Home Screen to open the **SPEED CONTROL** pop-up where you can adjust the speed.

Press **◀** and **▶** to adjust the playback speed.

After adjusting the speed, you can turn the VSA function OFF by pressing the **F1(⏻/⏮)** button (SPEED OFF).

When VSA is active, a number appears at the top of the Home Screen.

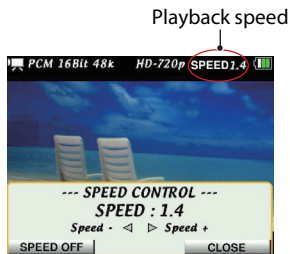

When the **SPEED CONTROL** pop-up is open, press the **F1(⏻/⏮)** button to turn speed control ON/OFF. This allows you to switch between the set speed and the normal speed easily.

The speed can be set in a range between 50% (x0.5) and 150% (x1.5) in 10% (0.1) increments (default: x1.0).

### NOTES

- You can use this function only in video and audio modes.
- Using the speed control function of this unit, the speed of audio is always changed without changing its pitch. You can also set this with the **SPEED** item on the **PB Control** screen.
- When using a file with 96kHz sampling frequency, the speed control function is automatically disabled and **SPEED** does not appear on the screen.



## Setting the playback speed (method 2)

You can set the playback speed control on the **PB Control** screen.

1. Press the **MENU** button to open the **MENU** screen.
2. Use the Pointing Stick to select the **PB CONTROL** menu item and then press the center of the Pointing Stick to open the **PB Control** screen.



3. Press **▶** or the center of the Pointing Stick.

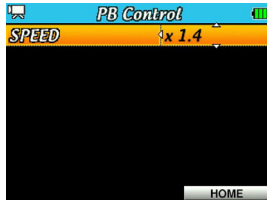

4. Press **▲** and **▼** to set the speed.  
The speed can be set in a range between x0.5 and x1.5 in x0.1 increments (default: x1.0).
5. When done changing this setting, press the **F3/HOME** button to return to the Home Screen.

## Deleting the selected file

Use the following procedure to delete the current file without opening the **BROWSE** screen.

1. On the Home Screen, use **◀** and **▶** to select the file you want to delete.
2. During playback or when playback is stopped or paused, press the **F2** button (**DELETE**) to open the **FILE DELETE** confirmation pop-up.



3. If you want to delete the file shown, press the **F1** (**⏏** / **I**) button (**YES**) to delete the file and close the pop-up. The next file in the playback area is loaded automatically in a stopped state.  
Press the **F3/HOME** button (**NO**) to cancel deletion and close the pop-up.

### NOTE

You can also delete files from the **BROWSE** screen. (See "File operations" on page 59.)

## 7 – Video and Audio Playback

---

### Uploading to video sharing sites

---

You can upload video files recorded by this unit to video sharing sites. For details, please see the TASCAM website (<http://tascam.com/>).

# 8 – Viewing a slide show of still photos

In addition to the playback of video and audio files, you can view a slide show of still images on this unit.

## Setting the operation mode

To view a slide show of still images on this unit, first activate photo mode. (See “Setting the operating mode” on page 35.)

## Setting the time each photo is shown

You can set the amount of time that each still image is shown.

1. Press the **MENU** button to open the **MENU** screen.
2. Use the Pointing Stick to select **PLAY** and press the center of the Pointing Stick to open the **Play Option** screen.



3. Press **▲** and **▼** to select **SLIDE SHOW** and press **▶** or the center of the Pointing Stick.

4. Press **▲** and **▼** to set the amount of time that each photo is shown in the slide show.



You can set the length from 1 sec to 10 sec in increments of 1 second. (default: 3 sec)

5. When setting is complete, press the **F3/HOME** button to return to the Home Screen.

## 8 – Viewing a slide show of still photos

---

### Playing the slide show

---

On the Home Screen, press the **PLAY** button to start playback.



---

### Stopping the slide show

---

On the Home Screen, press the **STOP/PAUSE** button during the slide show to pause on the current photo.

Press the **PLAY** button again to resume playback of the slide show from the same photo.

#### NOTE

Playback area and playlist settings also affect slide shows. For details, see "7 - Video and Audio Playback" starting on page 61.

## 9 – Connecting with a computer

By connecting this unit to a computer using a USB cable, you can transfer video, photo and audio files between the microSD card in the unit and the computer.

This unit can use files with the following formats.

### Video

MOV: SD and HD files recorded (video/audio) by a DR-V1HD

### Audio

WAV: 16 or 24-bit WAV with 44.1, 48 or 96kHz sampling frequency

### Image

JPG: JPEG files with 640x480 or 1280x720 resolution created by a DR-V1HD

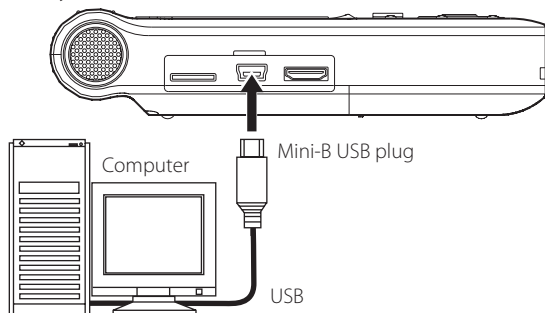

### NOTE

Instead of connecting the unit to a computer via USB, you can also conduct the same operations by removing the microSD card from the unit and loading it directly (or using a card adapter) on a computer.

### CAUTIONS

- USB bus power is not supported. So, batteries will be drained as usual when you connect the unit to a USB port.
- This unit cannot be operated when connected by USB.

When connected, the `USB connected` message appears on the display of the unit.



Make sure that the microSD card is inserted properly. If the microSD card is not loaded properly, a "NO SDCARD" pop-up message appears.

When loaded properly, this unit appears on the computer as an external volume named "DR-V1HD".

## 9 – Connecting with a computer

---

### Transferring files to a computer

---

1. Click the “DR-V1HD” drive on the computer screen to show the “MY\_FOLDER” and “UTILITY” folders.
2. Open “MY\_FOLDER” and drag and drop the files that you want to transfer to where you want them on the computer.

#### CAUTION

- USB bus power is not supported. So, batteries will be drained as usual when you connect the unit to a USB port.  
To transfer files to a computer, make sure that batteries have sufficient remaining power or use the TASCAM PS-P520 AC adapter (sold separately).
- Do not change the name of the MY\_FOLDER folder. If the name of this folder is changed, this unit will not be able to recognize the files in it.

---

### Transferring files from a computer

---

Only video and still image files recorded by this recorder can be loaded.

1. Click the “DR-V1HD” drive on the computer screen to show the “MY\_FOLDER” and “UTILITY” folders.
2. Open “MY\_FOLDER” and drag and drop the files on the computer that you want to transfer into this folder as you like.

#### TIPS

- You can manage “MY\_FOLDER” from the computer.
- You can create sub-folders in the “MY\_FOLDER” folder, but the unit only recognizes the first level of sub-folders. The unit will not recognize subfolders or their contents on the second level or below.
- Since you can set the unit to only play the contents of a specific folder, you can organize files into genres, artists or other categories as you like.
- By naming subfolders and songs as you like, you will be able to identify them by these names on the Home Screen and BROWSE screen on this unit.

#### CAUTION

- File names and folder names in Japanese and other languages that use multibyte encodings cannot be shown correctly.
- Do not change the name of the MY\_FOLDER folder. If the name of this folder is changed, this unit will not be able to recognize the files in it.

---

### Disconnecting from a computer

---

Before disconnecting the USB cable, follow the appropriate procedures for your computer to eject the unit (as an external drive). See the computer's operation manual for instructions about how to eject an external drive. After being ejected, the unit will shut down and power off automatically.

# 10 – Making other settings and viewing information

## Viewing File Information (INFORMATION)

Use the **INFORMATION** Screen to view various types of information about the unit.

Follow the procedures below to open the **INFORMATION** screen.

1. Press the **MENU** button to open the **MENU** screen.
2. Use the Pointing Stick to select **SETUP** and press the center of the Pointing Stick to open the **SETUP** screen.
3. Press **▲** and **▼** to select **INFORMATION** and press **▶** or the center of the Pointing Stick.
4. Press **▲** and **▼** to select the item you want to check and press the center of the Pointing Stick.

### **FILE**

Information about the currently loaded file

### **CARD**

Usage status of the currently inserted microSD card

### **SYSTEM**

Information about the unit's system settings and firmware version

5. When done changing the setting, press the **F3/HOME** button to return to the Home Screen.

## **INFORMATION (FILE)** screen

The **INFORMATION (FILE)** screen shows information about the currently loaded file.



The screenshot shows the 'INFORMATION (FILE)' screen with a blue header bar. Below the header, there is a table of file information. At the bottom right, there is a 'HOME' button.

INFORMATION (FILE)	
MOV	720p, 30fps, 7.72Mbps
	16bit, STEREO, 44.1K
TITLE	DR0000_0345.mov
DATE	2012/03/08 15:40
SIZE	8.7M byte

## **MOV/WAV/JPG**

Information, including resolution, frame rate, stereo/mono and sampling frequency, is shown according to the type of file currently loaded.

## **TITLE**

Shows the file name.

## **NOTE**

File names in Japanese and other languages that use multibyte encodings cannot be shown correctly.

## **DATE**

Shows the date of file creation.

## **SIZE**

Shows the file size.

## 10 – Making other settings and viewing information

### INFORMATION (CARD) screen

The INFORMATION (CARD) screen shows the usage status of the currently inserted microSD card.

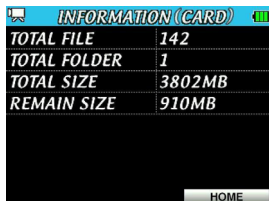

INFORMATION (CARD)	
TOTAL FILE	142
TOTAL FOLDER	1
TOTAL SIZE	3802MB
REMAIN SIZE	910MB

#### TOTAL FILE

Shows the number of playable files.

#### TOTAL FOLDER

Shows the number of folders.

#### TOTAL SIZE

Shows the total microSD card capacity.

#### REMAIN SIZE

Shows the remaining open capacity of the microSD card.

### INFORMATION (SYSTEM) screen

The INFORMATION (SYSTEM) screen shows the automatic power off and battery type settings as well as the system firmware version.

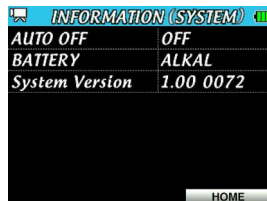

INFORMATION (SYSTEM)	
AUTO OFF	OFF
BATTERY	ALKAL
System Version	1.00 0072

#### AUTO OFF

Shows the AUTO OFF setting

#### BATTERY

Shows the battery type setting

#### System Version

Shows the system firmware version.

#### NOTE

The AUTO OFF and BATTERY settings cannot be changed on this screen. For instructions about changing these settings, see "Using the AUTO OFF function" and "Setting the battery type" on page 81.



## System settings (SETUP screen)

On the **SETUP** screen, you can change various settings to optimize the unit for your use environment and other requirements. You can also initialize the unit, and format microSD cards.

Follow the procedure below to open the **SETUP** screen.

1. Press the **MENU** button to open the **MENU** screen.
2. Use the Pointing Stick to select the **SETUP** menu item and then press the center of the Pointing Stick to open the **SETUP** screen.



3. Press **▲** and **▼** to select the item that you want to set. (See the following sections for details about each item on the **SETUP** screen.)
4. When done changing the setting, press the **F3/HOME** button to return to the Home Screen.

## Using the AUTO OFF function

Use the **AUTO OFF** item set how long until the power turns off automatically after the last use or operation.

Options : OFF, 3min, 5min, 10min, 30min(default)

## Using the backlight auto off function

Use the **BACKLIGHT** item to set the time until the back-light automatically turns off after the last operation when powered with batteries.

Options : ON (backlight not automatically turned off), 5sec, 10sec, 15sec, 30sec

## Adjusting the backlight brightness

Use the **DIMMER** item to adjust the backlight brightness.

Options : HIGH (default), LOW, ALL OFF (backlight off)

## Setting the battery type

Use the **BATTERY** item to set the type of the batteries used in the unit. This setting is used to show the amount of remaining battery charge and determine if the unit has enough power for normal operation.

Options: ALKAL (default, alkaline), NIMH (nickel-metal hydride)

## 10 – Making other settings and viewing information

### Setting the format of file names

Use the **FILE NAME** item on the **SETUP** screen to set the format of names given automatically to recorded files (video, audio and photo).

1. Press the **MENU** button to open the **MENU** screen.
2. Use the Pointing Stick to select **SETUP** and press the center of the Pointing Stick to open the **SETUP** screen.
3. Press **▲** and **▼** to select **FILE NAME** and press **▶** or the center of the Pointing Stick to open the **FILE NAME** screen.



4. Press **◀** and **▶** to change the selection, and press up and down to set each item.
5. Press the **F1(⏏/I)** button (SET) to confirm a change and return to the **SETUP** screen.

Press the **F3/HOME** button (INC CLEAR) to restart the automatic numbering added to incremented file names.

### File name format

Set the **TYPE** item to **WORD** or **DATE**.

**WORD**: (Default) The 6 characters set in the **WORD** item are used as the beginning of each file name.

Example: DR0000\_0000.mov

**DATE**: The date is used as the beginning of each file name in a **yymmdd** format.

Example: 090101\_0000.mov

#### NOTE

The date is set using the unit's internal clock. (See "Setting the date and time" on page 31.)

### Setting the WORD item

Select the **WORD** item, and use **◀** or **▶** to move the cursor. Press **▲** and **▼** to set the characters.

In addition to the English alphabet and numbers, the following characters can be used:

! # \$ % & ' ( ) + , - . : ; = @ [ ^ \_ ` { } .

## Formatting

Use the SD FORMAT item on the **SETUP** screen to fully format the microSD card. Fully formatting a card erases all music files on it and automatically creates new "MY\_FOLDER" and "UTILITY" folders, as well as a ".NVRAM.txt" file.

### CAUTION

Although you can access the ".NVRAM.txt" file when the recorder is connected to a computer if you edit it or otherwise change it, the recorder might stop functioning properly.

1. Press the **MENU** button to open the **MENU** screen.
2. Use the Pointing Stick to select **SETUP** and press the center of the Pointing Stick to open the **SETUP** screen.
3. Use the Pointing Stick to select the **SD FORMAT** item and press **▶** or the center of the Pointing Stick to open the following pop-up confirmation.

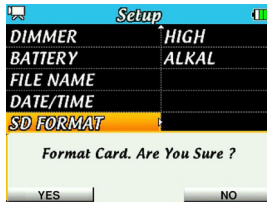

4. Press the **F1** (**⏻ / I**) button (YES) to start formatting. Press the **F3/HOME** button if you want to cancel formatting. When formatting completes, the following pop-up message opens.

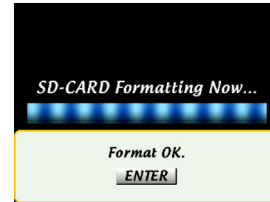

### CAUTION

When formatting a card, power the unit with a TASCAM PS-P520 AC adapter (sold separately) or make sure the batteries have sufficient remaining power. If the power fails during formatting, the formatting may not complete correctly.

5. Press the center of the Pointing Stick to return to the **SETUP** screen.

## 10 – Making other settings and viewing information

### Restoring the default settings

Use the INITIALIZE item on the **Setup** screen to restore the various settings of this unit to their factory default settings.

1. Press the **MENU** button to open the **MENU** screen.
2. Use the Pointing Stick to select **SETUP** and press the center of the Pointing Stick to open the **Setup** screen.
3. Use the Pointing Stick to select the INITIALIZE item and press **▶** or the center of the Pointing Stick to open the following pop-up confirmation.

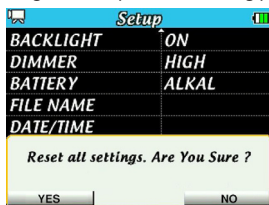

4. Press the **F1** (**⏏** / **1**) button (YES) to start initialization.  
Press the **F3/HOME** button (NO) to cancel initialization.

#### CAUTION

Initialization when a card is in use does not reset the file numbers added automatically to filenames.

To reset the file numbers, see the instructions in "Setting the format of file names" on page 82.

The following is a list of the pop-up messages that may appear under certain conditions.

Refer to this list if one of these pop-up messages appears and you want to check the meaning or determine a proper response.

Message	Meaning and response
Battery Empty	The batteries are out of power. Replace them. Alternatively, use a TASCAM PS-P520 AC adaptor (sold separately).
Can't Divide	The position selected for dividing is not suitable (too close to the beginning or end of the file). Divide the file at a suitable position.
Card Error	The unit could not use the card properly. Replace the card.
Card Full	The card has no remaining capacity. Erase unnecessary files or move them to a computer to make open space.
Dup File Name	The DIVIDE function has caused the file name to be the same as that of an existing file. The DIVIDE function adds “_a” or “_b” to the end of the original file name. Before dividing, connect the unit to a computer and edit the file name.
File Full	The total number of folders and files exceeds 9999. Erase unnecessary items or move them to your computer.
File Name ERR	The DIVIDE function has caused the file name to exceed 200 characters. The DIVIDE function adds “_a” or “_b” to the end of the original file name. Before dividing, connect the unit to a computer and edit the file name to 198 characters or less.
File Not Found	A file added to a playlist cannot be found. Please confirm that the file is in the active folder.
File Protected	The file is read-only so it cannot be deleted. Use a computer to delete read-only files.
Format Error Format CARD	The formatting of the card might be in-correct or the card might be broken. This message also appears if you format a card using a computer connected by USB or if you insert an unformatted card in the unit. Always use the DR-V1HD to format cards to be used with it. Change the card, or press the <b>F1</b> (⏻ /  ) button (YES) while this message appears to FAT format the card. FAT formatting erases all data on the card.
I/O Too Short	The interval between the IN and OUT points is too short. Set them at least one second apart.
Non-Supported	The file is not a supported format. Please see “9 – Connecting with a computer” for file formats that this unit can use.
No PLAYLIST	No files have been added to the playlist. Add a file to the playlist or change the play mode to something other than PLAYLIST.
Out Of Card Space	The SD card does not have enough open space to use the DIVIDE function. At least as much open space as the size of the file being divided is necessary. Delete unneeded files from the card. Back up files that you might want later to a computer before deleting them.
PLAYLIST Full	The playlist is full. You cannot add more than 99 files to a playlist.
Unsupported Sampling Rate!!	In video recording mode, recording is not possible when the sampling frequency is set to 96kHz. Set the sampling frequency to 44.1kHz or 48kHz.
Write Timeout	Writing to the card timed out. Backup the files on the card to a computer and format the card.
NO SDCARD	No microSD card is inserted in the recorder. Insert a card properly.
No File	There is no file that can be viewed when browsing.
No Movie File	There is no video file (mov) in the playback area.
No Audio File	There is no audio file (wav) in the playback area.

## 11 – Messages

Message	Meaning and response
No Photo File	There is no still image file (jpg) in the playback area.
System Error	An error has occurred related to the CPU, data transmission or another aspect of the system. If one of these errors occurs, turn the recorder's power OFF once and then restart it. If you are unable to turn the power off, remove the batteries and disconnect the TASCAM PS-P520 AC adaptor. If system errors occur frequently, please contact a TASCAM service center.

If you are having trouble with the operation of this unit, please try the following before seeking repair. If these measures do not solve the problem, please contact the store where you bought the unit or TASCAM Customer Support.

## Power will not turn ON.

- ➔ Confirm that the batteries are not dead.
- ➔ Make sure that the batteries are installed with the correct ⊕ / ⊖ orientations.
- ➔ If using a TASCAM PS-P520 AC adapter (sold separately), confirm that its plug is inserted securely into an outlet.

## The unit does not function.

- ➔ Confirm that the **HOLD** switch is not set in the direction of the arrow.
- ➔ Confirm that the unit is not connected by USB to a computer (unit display shows “USB Connected”).

## The microSD card is not recognized.

- ➔ Confirm that the microSD card is inserted completely.

## Playback does not work.

- ➔ This recorder can only play mov files that it created.
- ➔ If you are trying to play a WAV file, confirm that the sampling frequency is supported by this unit.

## No sound from the speaker.

- ➔ Are headphones connected?
- ➔ Is the **SPEAKER** switch set to OFF?

## No sound from connected monitoring system.

- ➔ Check the connections with the monitoring system.
- ➔ Is the volume of the monitoring system minimized?
- ➔ Is the **OUTPUT LEVEL** setting of the unit minimized?

## Recording (video/audio/photo) is not possible.

- ➔ If you are using an external device, check the connections again.
- ➔ Check the input settings again.
- ➔ Confirm that the recording level is not too low.
- ➔ Confirm that the microSD card is not full.
- ➔ Confirm that the number of files has not reached the maximum that the unit can handle.

## Input level is low.

- ➔ Confirm that the input level setting is not too low.
- ➔ Confirm that the gain setting is not too low.
- ➔ Confirm that the output level of any connected external device is not too low.

## The sound I am trying to record sounds distorted.

- ➔ Confirm that the **INPUT** volume setting is not too high.

## 12 – Troubleshooting

### **Playback sounds unnatural.**

- ➔ Confirm that the playback speed is not being adjusted.

### **I cannot erase a file.**

- ➔ Are you trying to erase a copy of a file that was set to read-only on a computer?

### **This unit's files do not appear on the computer.**

- ➔ Confirm that the unit's USB port is connected to the computer.
- ➔ Confirm that you are not using a USB hub.
- ➔ Confirm that the unit is not recording or in recording standby mode (audio/video/photo).



---

## Media and formats

---

### Recording media

microSD card (64 MB – 2 GB)  
microSDHC card (4 GB – 32 GB)

### Video recording/playback format

MOV  
Video compression method : MPEG4-SP  
Audio : WAV 44.1/48kHz, 16/24-bit  
Resolution : SD 640×480 (30 fps)  
HD 1280×720 (30 fps)

### Audio recording/playback format

WAV : 44.1/48/96kHz, 16/24-bit

### Still image format

Size : 0.3M 640×480  
0.9M 1024×720

### Number of channels

Video/photo : 1  
Audio : 2 (stereo)

---

## Inputs and outputs

---

### Analog audio input and output

#### MIC/LINE IN jack (plug-in power supported)

Connector : 1/8" (3.5mm) stereo mini jack  
INPUT SELECT set to MIC  
Input impedance : 25 k $\Omega$   
Nominal input level  
GAIN LOW : -32 dBV  
GAIN MID : -48 dBV  
GAIN HIGH : -64 dBV  
Maximum input level  
GAIN LOW : -16 dBV  
GAIN MID : -32 dBV  
GAIN HIGH : -48 dBV

INPUT SELECT set to LINE  
Input impedance : 22 k $\Omega$   
Nominal input level : -10 dBV (0.32 V)  
Minimum input level : -22 dBV (0.08 V)  
Maximum input level : +6 dBV (2.0 V)

#### $\Omega$ /LINE OUT jack

Connector : 1/8" (3.5 mm) stereo mini jack  
Output impedance : 12  $\Omega$   
Nominal output level : -14 dBV (10 k $\Omega$  load)  
Maximum output level : +2 dBV (10 k $\Omega$  load)  
Maximum output : 15 mW + 15 mW (32 $\Omega$  load)

#### Built-in speaker

0.6 W (monaural)

## 13 – Specifications

### Built-in microphone

Electret condenser microphone pair (stereo)

Directivity : Unidirectional

Sensitivity : -37 dB at 1 kHz (0 dB = 1 V/Pa) RL = 2 k $\Omega$ , Vcc = 3 V

Impedance : 1.4 k $\Omega$   $\pm$ 30% at 1 kHz (RL = 2 k $\Omega$ )

S/N ratio : 74 dB typical at 1 kHz (A-Weight)

Maximum input sound pressure level (SPL) : 120 dB

### Built-in camera

Image sensor : 1/4-inch CMOS

Resolution : 1.0 megapixel (1280 x 800)

Lens Angle of view : 64°

Focal length : 39 cm $\rightarrow$  $\infty$

### Digital connections

#### USB port

Connector : Mini-B type

Format : USB 2.0 Hi-Speed mass storage device class

#### mini-HDMI port

Connector : Type C

---

### Audio performance

---

#### Frequency response

20 Hz – 20 kHz +1/-3 dB (LINE IN to LINE OUT, 44.1 kHz, JEITA)

20 Hz – 22 kHz +1/-3 dB (LINE IN to LINE OUT, 48 kHz, JEITA)

20 Hz – 40 kHz +1/-3 dB (LINE IN to LINE OUT, 96 kHz, JEITA)

#### Total harmonic distortion

0.02% or less (LINE IN to LINE OUT, 44.1/48/96 kHz, JEITA)

#### S/N ratio

90 dB or more (LINE IN to LINE OUT, 44.1/48/96 kHz, JEITA)

Note: JEITA CP-2150 measurement methods used

## Computer compatibility

Visit the TASCAM website (<http://tascam.com/>) for updated information about operating system compatibility.

### Windows

Pentium (300 MHz or faster)  
128 MB or more memory  
USB port (USB 2.0 recommended)

### Macintosh

Power PC, iMac, G3, G4 (266 MHz or faster)  
64 MB or more memory  
USB port (USB 2.0 recommended)

### Recommended USB host controller

Intel chipset

### Supported operating systems

Windows: Windows XP, Windows Vista, Windows 7  
Macintosh: Mac OS X 10.2 or later

## Other specifications

### Power supply

Three AA batteries (Alkaline or Ni-MH)  
TASCAM PS-P520 AC adaptor (sold separately)

### Power consumption

0.9 W (maximum)

### Battery operation time (continuous)

- Alkaline type battery (EVOLTA)

Operation	File format	Continuous operation time (approximate)	Note
Video mode	Recording HD-720p video with 48kHz, 24-bit audio	3.5 hours	Using built-in stereo microphone and headphones
	Recording SD-VGA video with 44.1kHz, 16-bit audio	4.5 hours	Using built-in stereo microphone and headphones
	Playing HD-720p video with 48kHz, 24-bit audio	4.5 hours	Using headphones
	Playing SD-VGA video with 44.1kHz, 16-bit audio	5.5 hours	Using headphones
Audio mode	Recording 96kHz, 24-bit audio	5 hours	Using built-in stereo microphone and headphones
	Recording 44.1kHz, 16-bit audio	6 hours	Using built-in stereo microphone and headphones
	Playing 96kHz, 24-bit audio	6 hours	Using headphones
	Playing 44.1kHz, 16-bit audio	6.5 hours	Using headphones

Note: times for music recording and playback measured using JEITA methods

## 13 – Specifications

- Ni-MH type battery (eneloop)

Operation	File format	Continuous operation time (approximate)	Note
Video mode	Recording HD-720p video with 48kHz, 24-bit audio	4.5 hours	Using built-in stereo microphone and headphones
	Recording SD-VGA video with 44.1kHz, 16-bit audio	5.5 hours	Using built-in stereo microphone and headphones
	Playing HD-720p video with 48kHz, 24-bit audio	5 hours	Using headphones
	Playing SD-VGA video with 44.1kHz, 16-bit audio	6 hours	Using headphones
Audio mode	Recording 96kHz, 24-bit audio	5.5 hours	Using built-in stereo microphone and headphones
	Recording 44.1kHz, 16-bit audio	6.5 hours	Using built-in stereo microphone and headphones
	Playing 96kHz, 24-bit audio	5 hours	Using headphones
	Playing 44.1kHz, 16-bit audio	6 hours	Using headphones

Note: times for music recording and playback measured using JEITA methods

### Dimensions

70 × 131 × 28 mm (W × H × D)

### Weight

157 g (excluding batteries)

### Operating temperature range

0–35°C

## Dimensional drawings

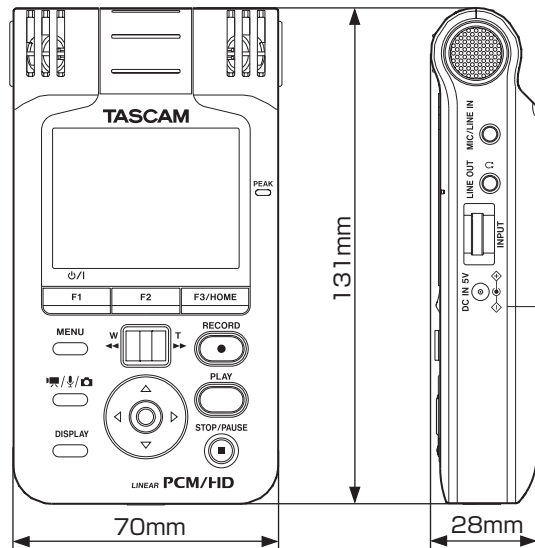

- Illustrations in this manual might differ in part from the actual product.
- Specifications and external appearance may be changed without notification in order to improve the product.

# 14 – Important notice regarding software

## Software License Agreement

END-USER LICENSE AGREEMENT FOR APPLICATION SOFTWARE ATTACHED TO TEAC PRODUCTS

### IMPORTANT - READ CAREFULLY:

This End-User License Agreement is a legal agreement between you (either an individual or a single entity) and TEAC Corporation ("TEAC") for the software identified above, which includes computer software and associated media and printed materials (if any), and may include online or electronic documentation (hereinafter referred to as SOFTWARE). By installing, copying, or otherwise using the SOFTWARE, you agree to be bound by the terms of this Agreement. If you do not agree to the terms of this Agreement, you are not authorized to use the SOFTWARE.

The SOFTWARE is protected by copyright laws and international copyright treaties, as well as other intellectual property laws and treaties. The SOFTWARE is licensed, not sold.

#### 1 GRANT OF LICENSE.

This Agreement grants you the following rights:  
Use and Copy. TEAC grants to you the right to use copies of the SOFTWARE only for TEAC PRODUCTS you have. You may also make a copy of the SOFTWARE for backup and archival purposes.

#### 2 RESTRICTIONS.

You may not distribute copies of the SOFTWARE to third parties.  
You may not rent or lease the SOFTWARE.

#### 3 TERMINATION.

Your rights under this Agreement terminate upon the disposal of your TEAC PRODUCTS, or without prejudice to any other rights, TEAC may terminate this Agreement if you fail to comply with the terms and conditions of this Agreement. In such event, you must destroy all copies of the SOFTWARE.

#### 4 COPYRIGHT.

All title and copyrights in and to the SOFTWARE and any copies thereof are owned by TEAC or its suppliers. All title and intellectual property rights in and to the content which may be accessed through use of the SOFTWARE is the property of the respective content owner and may be protected by applicable copyright or other intellectual property laws and treaties. This Agreement grants you no rights to use such content.

#### 5 NO WARRANTY.

ANY USE OF THE SOFTWARE IS AT YOUR OWN RISK. THE SOFTWARE IS PROVIDED FOR USE ONLY FOR TEAC PRODUCTS. TO THE MAXIMUM EXTENT PERMITTED BY APPLICABLE LAW, TEAC AND ITS SUPPLIERS DISCLAIM ALL WARRANTIES AND CONDITIONS, EITHER EXPRESS OR IMPLIED, INCLUDING, BUT NOT LIMITED TO, IMPLIED WARRANTIES OF MERCHANTABILITY, FITNESS FOR A PARTICULAR PURPOSE, AND NONINFRINGEMENT.

#### 6 NO LIABILITY FOR CONSEQUENTIAL DAMAGES.

TO THE MAXIMUM EXTENT PERMITTED BY APPLICABLE LAW, IN NO EVENT SHALL TEAC OR ITS SUPPLIERS BE LIABLE FOR ANY SPECIAL INCIDENTAL, INDIRECT, OR CONSEQUENTIAL DAMAGES WHATSOEVER (INCLUDING, WITHOUT LIMITATION, DAMAGES FOR LOSS OF BUSINESS PROFITS, BUSINESS INTERRUPTION, LOSS OF BUSINESS INFORMATION, OR ANY OTHER PECUNIARY LOSS) ARISING OUT OF THE USE OF OR INABILITY TO USE THE SOFTWARE, EVEN IF TEAC HAS BEEN ADVISED OF THE POSSIBILITY OF SUCH DAMAGES. BECAUSE SOME STATES AND JURISDICTIONS DO NOT ALLOW THE EXCLUSION OR LIMITATION OF LIABILITY FOR CONSEQUENTIAL OR INCIDENTAL DAMAGES, THE ABOVE LIMITATION MAY NOT APPLY TO YOU.

#### 7 LIMITATION OF LIABILITY.

TEAC'S ENTIRE LIABILITY AND YOUR EXCLUSIVE REMEDY UNDER THIS AGREEMENT SHALL NOT EXCEED THE PRICE YOU PAID FOR TEAC PRODUCTS.

#### 8 MISCELLANEOUS.

This Agreement is governed by the laws of Japan.

## 14 – Important notice regarding software

### NOTICE

The reproduction and use of copyrighted materials such as music, images, computer programs and databases are limited by the copyright and other laws or by the license agreement made by and between the copyright holders and users. Before making a reproduction of such materials, check their conditions of use and use this product without infringing the copyrights or other intellectual property rights. TEAC has no responsibility for copyright infringement as a result of reproductions of copyrighted works made by users of this product.

### NOTE

Any data, including, but not limited to information, described herein are intended only as illustrations of such data and/or information and not as the specifications for such data and/or information. TEAC CORPORATION disclaims any warranty that any use of such data and/or information shall be free from infringement of any third party's intellectual property rights or other proprietary rights, and further, assumes no liability of whatsoever nature in the event of any such infringement, or arising from or connected with or related to the use of such data and/or information.

### List of packages

(GNU GPL)

Linux-kernel.tar.gz

Advanced Linux Sound Architecture ALSA

busybox

(BSD)

DMAI

## Notice regarding software that uses the GNU GPL

### About the licensing of software used in this product

The software included in this product is comprised of multiple discrete software applications, and the copyrights of each of these belong to various third parties.

This product includes software covered by end-user license agreements (hereafter, "EULA") stipulated by third parties.

Among these is the GNU General Public License (hereafter, "GPL") for free executable software applications. As a condition for the distribution of software covered by the GPL, the source code for such software must be made available. If you wish to obtain the source code for such software, you may do so by accessing the following URL and filling out a registration form.

<http://www.teac.co.jp/support/opensource/index.html>

Please understand that we are unable to respond to questions about the source code contents and similar matters.

Source code will not be provided for software covered by EULAs other than the GPL.

Software distributed in accordance with the GPL allows customers to use it without charge, but, to the extent of applicable laws, no explicit or implicit guarantees are provided for such software.

With the exceptions of provisions of applicable laws and written agreements, the copyright holders and those who change and redistribute such software with the permission described above will bear no responsibility for any loss caused by the use of or the inability to use such software. Please read the GPL for details about, for example, conditions for use and provisions that must be followed regarding such software.

Before using software or software components that are included in this product and subject to the GPL, please read the following GNU GENERAL PUBLIC LICENSE carefully. Moreover, since the provisions of this license are set by a third party, we provide it in its original language (English).

### **GNU GENERAL PUBLIC LICENSE Version 2, June 1991**

Copyright (C) 1989, 1991 Free Software Foundation, Inc., 51 Franklin Street, Fifth Floor, Boston, MA 02110-1301 USA

Everyone is permitted to copy and distribute verbatim copies of this license document, but changing it is not allowed.

#### **Preamble**

The licenses for most software are designed to take away your freedom to share and change it. By contrast, the GNU General Public License is intended to guarantee your freedom to share and change free software—to make sure the software is free for all its users. This General Public License applies to most of the Free Software Foundation's software and to any other program whose authors commit to using it. (Some other Free Software Foundation software is covered by the GNU Library General Public License instead.) You can apply it to your programs, too.

When we speak of free software, we are referring to freedom, not price. Our General Public Licenses are designed to make sure that you have the freedom to distribute copies of free software (and charge for this service if you wish), that you receive source code or can get it if you want it, that you can change the software or use pieces of it in new free programs; and that you know you can do these things.

To protect your rights, we need to make restrictions that forbid anyone to deny you these rights or to ask you to surrender the rights. These restrictions translate to certain responsibilities for you if you distribute copies of the software, or if you modify it.

For example, if you distribute copies of such a program, whether gratis or for a fee, you must give the recipients all the rights that you have. You must make sure that they, too, receive or can get the source code. And you must show them these terms so they know their rights.

We protect your rights with two steps: (1) copyright the software, and (2) offer you this license which gives you legal permission to copy, distribute and/or modify the software.

Also, for each author's protection and ours, we want to make certain that everyone understands that there is no warranty for this free software. If the software is modified by someone else and passed on, we want its recipients to know that what they have is not the original, so that any problems introduced by others will not reflect on the original authors' reputations.

Finally, any free program is threatened constantly by software patents. We wish to avoid the danger that redistributors of a free program will individually obtain patent licenses, in effect making the program proprietary. To prevent this, we have made it clear that any patent must be licensed for everyone's free use or not licensed at all.

The precise terms and conditions for copying, distribution and modification follow.

### **GNU GENERAL PUBLIC LICENSE TERMS AND CONDITIONS FOR COPYING, DISTRIBUTION AND MODIFICATION**

0. This License applies to any program or other work which contains a notice placed by the copyright holder saying it may be distributed under the terms of this General Public License. The "Program", below, refers to any such program or work, and a "work based on the Program" means either the Program or any derivative work under copyright law: that is to say, a work containing the Program or a portion of it, either verbatim or with modifications and/or translated into another language. (Hereinafter, translation is included without limitation in the term "modification".) Each licensee is addressed as "you".

Activities other than copying, distribution and modification are not covered by this License; they are outside its scope. The act of running the Program is not restricted, and the output from the Program is covered only if its contents constitute a work based on the Program (independent of having been made

## 14 – Important notice regarding software

by running the Program). Whether that is true depends on what the Program does.

1. You may copy and distribute verbatim copies of the Program's source code as you receive it, in any medium, provided that you conspicuously and appropriately publish on each copy an appropriate copyright notice and disclaimer of warranty; keep intact all the notices that refer to this License and to the absence of any warranty; and give any other recipients of the Program a copy of this License along with the Program.

You may charge a fee for the physical act of transferring a copy, and you may at your option offer warranty protection in exchange for a fee.

2. You may modify your copy or copies of the Program or any portion of it, thus forming a work based on the Program, and copy and distribute such modifications or work under the terms of Section 1 above, provided that you also meet all of these conditions:

- a) You must cause the modified files to carry prominent notices stating that you changed the files and the date of any change.
- b) You must cause any work that you distribute or publish, that in whole or in part contains or is derived from the Program or any part thereof, to be licensed as a whole at no charge to all third parties under the terms of this License.
- c) If the modified program normally reads commands interactively when run, you must cause it, when started running for such interactive use in the most ordinary way, to print or display an announcement including an appropriate copyright notice and a notice that there is no warranty (or else, saying that you provide a warranty) and that users may redistribute the program under these conditions, and telling the user how to view a copy of this License. (Exception: if the Program itself is interactive but does not normally print such an announcement, your work based on the Program is not required to print an announcement.)

These requirements apply to the modified work as a whole. If identifiable sections of that work are not derived from the Program, and can be reasonably considered independent and separate works in themselves, then this License, and its terms, do not apply to those sections when you distribute them as separate works. But when you distribute the same sections as part of a whole which is a work based on the Program, the distribution of the whole must be on the terms of this License, whose permissions for other licensees extend to the entire whole, and thus to each and every part regardless of who wrote it.

Thus, it is not the intent of this section to claim rights or contest your rights to work written entirely by you; rather, the intent is to exercise the right to control the distribution of derivative or collective works based on the Program.

In addition, mere aggregation of another work not based on the Program with the Program (or with a work based on the Program) on a volume of a storage or distribution medium does not bring the other work under the scope of this License.

3. You may copy and distribute the Program (or a work based on it, under Section 2) in object code or executable form under the terms of Sections 1 and 2 above provided that you also do one of the following:

- a) Accompany it with the complete corresponding machine-readable source code, which must be distributed under the terms of Sections 1 and 2 above on a medium customarily used for software interchange; or,
- b) Accompany it with a written offer, valid for at least three years, to give any third party, for a charge no more than your cost of physically performing source distribution, a complete machine-readable copy of the corresponding source code, to be distributed under the terms of Sections 1 and 2 above on a medium customarily used for software interchange; or,



## 14 – Important notice regarding software

c) Accompany it with the information you received as to the offer to distribute corresponding source code. (This alternative is allowed only for noncommercial distribution and only if you received the program in object code or executable form with such an offer, in accord with Subsection b above.)

The source code for a work means the preferred form of the work for making modifications to it. For an executable work, complete source code means all the source code for all modules it contains, plus any associated interface definition files, plus the scripts used to control compilation and installation of the executable. However, as a special exception, the source code distributed need not include anything that is normally distributed (in either source or binary form) with the major components (compiler, kernel, and so on) of the operating system on which the executable runs, unless that component itself accompanies the executable.

If distribution of executable or object code is made by offering access to copy from a designated place, then offering equivalent access to copy the source code from the same place counts as distribution of the source code, even though third parties are not compelled to copy the source along with the object code.

4. You may not copy, modify, sublicense, or distribute the Program except as expressly provided under this License. Any attempt otherwise to copy, modify, sublicense or distribute the Program is void, and will automatically terminate your rights under this License. However, parties who have received copies, or rights, from you under this License will not have their licenses terminated so long as such parties remain in full compliance.

5. You are not required to accept this License, since you have not signed it. However, nothing else grants you permission to modify or distribute the Program or its derivative works. These actions are prohibited by law if you do not accept this License. Therefore, by modifying or distributing the Program (or any work based on the Program), you indicate your acceptance of this License to do so, and all its terms and conditions for copying, distributing or modifying the Program or works based on it.

6. Each time you redistribute the Program (or any work based on the Program), the recipient automatically receives a license from the original licensor to copy, distribute or modify the Program subject to these terms and conditions. You may not impose any further restrictions on the recipients' exercise of the rights granted herein. You are not responsible for enforcing compliance by third parties to this License.

7. If, as a consequence of a court judgment or allegation of patent infringement or for any other reason (not limited to patent issues), conditions are imposed on you (whether by court order, agreement or otherwise) that contradict the conditions of this License, they do not excuse you from the conditions of this License. If you cannot distribute so as to satisfy simultaneously your obligations under this License and any other pertinent obligations, then as a consequence you may not distribute the Program at all. For example, if a patent license would not permit royalty-free redistribution of the Program by all those who receive copies directly or indirectly through you, then the only way you could satisfy both it and this License would be to refrain entirely from distribution of the Program.

If any portion of this section is held invalid or unenforceable under any particular circumstance, the balance of the section is intended to apply and the section as a whole is intended to apply in other circumstances.

It is not the purpose of this section to induce you to infringe any patents or other property right claims or to contest validity of any such claims; this section has the sole purpose of protecting the integrity of the free software distribution system, which is implemented by public license practices. Many people have made generous contributions to the wide range of software distributed through that system in reliance on consistent application of that system; it is up to the author/donor to decide if he or she is willing to distribute software through any other system and a licensee cannot impose that choice.

## 14 – Important notice regarding software

This section is intended to make thoroughly clear what is believed to be a consequence of the rest of this License.

8. If the distribution and/or use of the Program is restricted in certain countries either by patents or by copyrighted interfaces, the original copyright holder who places the Program under this License may add an explicit geographical distribution limitation excluding those countries, so that distribution is permitted only in or among countries not thus excluded. In such case, this License incorporates the limitation as if written in the body of this License.

9. The Free Software Foundation may publish revised and/or new versions of the General Public License from time to time. Such new versions will be similar in spirit to the present version, but may differ in detail to address new problems or concerns.

Each version is given a distinguishing version number. If the Program specifies a version number of this License which applies to it and "any later version", you have the option of following the terms and conditions either of that version or of any later version published by the Free Software Foundation. If the Program does not specify a version number of this License, you may choose any version ever published by the Free Software Foundation.

10. If you wish to incorporate parts of the Program into other free programs whose distribution conditions are different, write to the author to ask for permission. For software which is copyrighted by the Free Software Foundation, write to the Free Software Foundation; we sometimes make exceptions for this. Our decision will be guided by the two goals of preserving the free status of all derivatives of our free software and of promoting the sharing and reuse of software generally.

### NO WARRANTY

11. BECAUSE THE PROGRAM IS LICENSED FREE OF CHARGE, THERE IS NO WARRANTY FOR THE PROGRAM, TO THE EXTENT PERMITTED BY APPLICABLE LAW. EXCEPT WHEN OTHERWISE STATED IN WRITING THE COPYRIGHT HOLDERS AND/OR OTHER PARTIES PROVIDE THE PROGRAM "AS IS" WITHOUT

WARRANTY OF ANY KIND, EITHER EXPRESSED OR IMPLIED, INCLUDING, BUT NOT LIMITED TO, THE IMPLIED WARRANTIES OF MERCHANTABILITY AND FITNESS FOR A PARTICULAR PURPOSE. THE ENTIRE RISK AS TO THE QUALITY AND PERFORMANCE OF THE PROGRAM IS WITH YOU. SHOULD THE PROGRAM PROVE DEFECTIVE, YOU ASSUME THE COST OF ALL NECESSARY SERVICING, REPAIR OR CORRECTION.

12. IN NO EVENT UNLESS REQUIRED BY APPLICABLE LAW OR AGREED TO IN WRITING WILL ANY COPYRIGHT HOLDER, OR ANY OTHER PARTY WHO MAY MODIFY AND/OR REDISTRIBUTE THE PROGRAM AS PERMITTED ABOVE, BE LIABLE TO YOU FOR DAMAGES, INCLUDING ANY GENERAL, SPECIAL, INCIDENTAL OR CONSEQUENTIAL DAMAGES ARISING OUT OF THE USE OR INABILITY TO USE THE PROGRAM (INCLUDING BUT NOT LIMITED TO LOSS OF DATA OR DATA BEING RENDERED INACCURATE OR LOSSES SUSTAINED BY YOU OR THIRD PARTIES OR A FAILURE OF THE PROGRAM TO OPERATE WITH ANY OTHER PROGRAMS), EVEN IF SUCH HOLDER OR OTHER PARTY HAS BEEN ADVISED OF THE POSSIBILITY OF SUCH DAMAGES.

### END OF TERMS AND CONDITIONS

#### How to Apply These Terms to Your New Programs

If you develop a new program, and you want it to be of the greatest possible use to the public, the best way to achieve this is to make it free software which everyone can redistribute and change under these terms.

To do so, attach the following notices to the program. It is safest to attach them to the start of each source file to most effectively convey the exclusion of warranty; and each file should have at least the "copyright" line and a pointer to where the full notice is found.

```
<one line to give the program's name and a brief idea of what it does.>
Copyright (C) <year> <name of author>
```

This program is free software; you can redistribute it and/or modify it under the terms of the GNU General Public License as published by the

## 14 – Important notice regarding software

Free Software Foundation; either version 2 of the License, or (at your option) any later version.

This program is distributed in the hope that it will be useful, but WITHOUT ANY WARRANTY; without even the implied warranty of MERCHANTABILITY or FITNESS FOR A PARTICULAR PURPOSE. See the GNU General Public License for more details.

You should have received a copy of the GNU General Public License along with this program; if not, write to the Free Software Foundation, Inc., 51 Franklin Street, Fifth Floor, Boston, MA 02110- 1301 USA.

Also add information on how to contact you by electronic and paper mail.

If the program is interactive, make it output a short notice like this when it starts in an interactive mode:

```
Gnomovision version 69, Copyright (C) year name of author Gnomovision
comes with ABSOLUTELY NO WARRANTY; for details type `show w'. This
is free software, and you are welcome to redistribute it under certain
conditions; type `show c' for details.
```

The hypothetical commands ``show w'` and ``show c'` should show the appropriate parts of the General Public License. Of course, the commands you use may be called something other than ``show w'` and ``show c'`; they could even be mouseclicks or menu items-- whatever suits your program.

You should also get your employer (if you work as a programmer) or your school, if any, to sign a "copyright disclaimer" for the program, if necessary. Here is a sample; alter the names:

```
Yoyodyne, Inc., hereby disclaims all copyright interest in the program
`Gnomovision' (which makes passes at compilers) written by James
Hacker.
```

```
<signature of Ty Coon>, 1 April 1989
Ty Coon, President of Vice
```

This General Public License does not permit incorporating your program into proprietary programs. If your program is a subroutine library, you may consider it more useful to permit linking proprietary applications with the library.

## 14 – Important notice regarding software

---

### Notice regarding software that uses the BSD

---

#### BSD

Copyright (C) 2010 Texas Instruments Incorporated - <http://www.ti.com/>

Redistribution and use in source and binary forms, with or without modification, are permitted provided that the following conditions are met:

Redistributions of source code must retain the above copyright notice, this list of conditions and the following disclaimer.

Redistributions in binary form must reproduce the above copyright notice, this list of conditions and the following disclaimer in the documentation and/or other materials provided with the distribution.

Neither the name of Texas Instruments Incorporated nor the names of its contributors may be used to endorse or promote products derived from this software without specific prior written permission.

THIS SOFTWARE IS PROVIDED BY THE COPYRIGHT HOLDERS AND CONTRIBUTORS "AS IS" AND ANY EXPRESS OR IMPLIED WARRANTIES, INCLUDING, BUT NOT LIMITED TO, THE IMPLIED WARRANTIES OF MERCHANTABILITY AND FITNESS FOR A PARTICULAR PURPOSE ARE DISCLAIMED. IN NO EVENT SHALL THE COPYRIGHT OWNER OR CONTRIBUTORS BE LIABLE FOR ANY DIRECT, INDIRECT, INCIDENTAL, SPECIAL, EXEMPLARY, OR CONSEQUENTIAL DAMAGES (INCLUDING, BUT NOT LIMITED TO, PROCUREMENT OF SUBSTITUTE GOODS OR SERVICES; LOSS OF USE, DATA, OR PROFITS; OR BUSINESS INTERRUPTION) HOWEVER CAUSED AND ON ANY THEORY OF LIABILITY, WHETHER IN CONTRACT, STRICT LIABILITY, OR TORT (INCLUDING NEGLIGENCE OR OTHERWISE) ARISING IN ANY WAY OUT OF THE USE OF THIS SOFTWARE, EVEN IF ADVISED OF THE POSSIBILITY OF SUCH DAMAGE.



# TASCAM

# DR-V1HD

## User registration

Customers in the USA, please visit the TASCAM website (<http://tascam.com/>) to register as a user online.

### TEAC CORPORATION

Phone: +81-42-356-9143  
1-47 Ochiai, Tama-shi, Tokyo 206-8530 Japan

<http://tascam.jp/>

### TEAC AMERICA, INC.

Phone: +1-323-726-0303  
7733 Telegraph Road, Montebello, California 90640 USA

<http://tascam.com/>

### TEAC CANADA LTD.

Phone: +1905-890-8008 Facsimile: +1905-890-9888  
5939 Wallace Street, Mississauga, Ontario L4Z 1Z8, Canada

<http://tascam.com/>

### TEAC MEXICO, S.A. de C.V.

Phone: +52-55-5010-6000  
Río Churubusco 364, Colonia Del Carmen, Delegación Coyoacán, CP 04100, México DF, México

<http://www.teacmexico.net/>

### TEAC UK LIMITED

Phone: +44-8451-302511  
Suites 19 & 20, Building 6, Croxley Green Business Park, Hatters Lane, Watford, Hertfordshire. WD18 8TE, U.K.

<http://www.tascam.co.uk/>

### TEAC EUROPE GmbH

Phone: +49-611-71580  
Bahnstrasse 12, 65205 Wiesbaden-Erbenheim, Germany

<http://tascam.de/>

Printed in China

## Free Manuals Download Website

<http://myh66.com>

<http://usermanuals.us>

<http://www.somanuals.com>

<http://www.4manuals.cc>

<http://www.manual-lib.com>

<http://www.404manual.com>

<http://www.luxmanual.com>

<http://aubethermostatmanual.com>

Golf course search by state

<http://golfingnear.com>

Email search by domain

<http://emailbydomain.com>

Auto manuals search

<http://auto.somanuals.com>

TV manuals search

<http://tv.somanuals.com>