

# DP-008

## 8-Track Digital Pocketstudio

### OWNER'S MANUAL

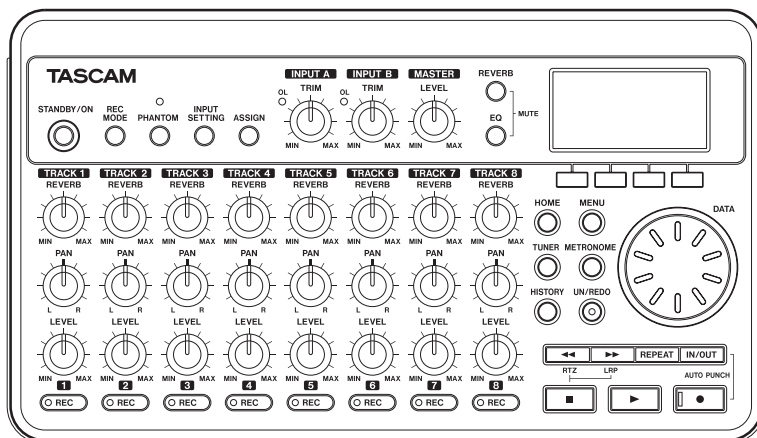

# IMPORTANT SAFETY INFORMATION



**CAUTION**  
RISK OF ELECTRIC SHOCK  
DO NOT OPEN



CAUTION: TO REDUCE THE RISK OF ELECTRIC SHOCK, DO NOT REMOVE COVER (OR BACK). NO USER-SERVICEABLE PARTS INSIDE. REFER SERVICING TO QUALIFIED SERVICE PERSONNEL.



The lightning flash with arrowhead symbol, within equilateral triangle, is intended to alert the user to the presence of uninsulated "dangerous voltage" within the product's enclosure that may be of sufficient magnitude to constitute a risk of electric shock to persons.



The exclamation point within an equilateral triangle is intended to alert the user to the presence of important operating and maintenance (servicing) instructions in the literature accompanying the appliance.

This appliance has a serial number located on the bottom panel. Please record the model number and serial number and retain them for your records.

Model number \_\_\_\_\_

Serial number \_\_\_\_\_

**WARNING: TO PREVENT FIRE  
OR SHOCK HAZARD, DO NOT  
EXPOSE THIS  
APPLIANCE TO RAIN OR  
MOISTURE.**

## FOR U.S.A. TO THE USER

This equipment has been tested and found to comply with the limits for a Class B digital device, pursuant to Part 15 of the FCC Rules. These limits are designed to provide reasonable protection against harmful interference in a residential installation. This equipment generates, uses, and can radiate radio frequency energy and, if not installed and used in accordance with the instruction manual, may cause harmful interference to radio communications. However, there is no guarantee that interference will not occur in a particular installation. If this equipment does cause harmful interference to radio or television reception, which can be determined by turning the equipment off and on, the user is encouraged to try to correct the interference by one or more of the following measures.

- Reorient or relocate the receiving antenna.
- Increase the separation between the equipment and receiver.
- Connect the equipment into an outlet on a circuit different from that to which the receiver is connected.
- Consult the dealer or an experienced radio/TV technician for help.

### CAUTION

Changes or modifications to this equipment not expressly approved by TEAC CORPORATION for compliance could void the user's authority to operate this equipment.

### Declaration of Conformity

Model Number : DP-008  
Trade Name : TASCAM  
Responsible party : TEAC AMERICA, INC.  
Address : 7733 Telegraph Road, Montebello,  
California, U.S. A.  
Telephone number : 1-323-726-0303

This device complies with Part 15 of the FCC Rules. Operation is subject to the following two conditions: (1) this device may not cause harmful interference, and (2) this device must accept any interference received, including interference that may cause undesired operation.

# IMPORTANT SAFETY INFORMATION

- 1 Read these instructions.
  - 2 Keep these instructions.
  - 3 Heed all warnings.
  - 4 Follow all instructions.
  - 5 Do not use this apparatus near water.
  - 6 Clean only with dry cloth.
  - 7 Do not block any ventilation openings. Install in accordance with the manufacturer's instructions.
  - 8 Do not install near any heat sources such as radiators, heat registers, stoves, or other apparatus (including amplifiers) that produce heat.
  - 9 Do not defeat the safety purpose of the polarized or grounding-type plug. A polarized plug has two blades with one wider than the other. A grounding type plug has two blades and a third grounding prong. The wide blade or the third prong are provided for your safety. If the provided plug does not fit into your outlet, consult an electrician for replacement of the obsolete outlet.
  - 10 Protect the power cord from being walked on or pinched particularly at plugs, convenience receptacles, and the point where they exit from the apparatus.
  - 11 Only use attachments/accessories specified by the manufacturer.
  - 12 Use only with the cart, stand, tripod, bracket, or table specified by the manufacturer, or sold with the apparatus. When a cart is used, use caution when moving the cart/apparatus combination to avoid injury from tip-over.
- 
- 13 Unplug this apparatus during lightning storms or when unused for long periods of time.
  - 14 Refer all servicing to qualified service personnel. Servicing is required when the apparatus has been damaged in any way, such as power-supply cord or plug is damaged, liquid has been spilled or objects have fallen into the apparatus, the apparatus has been exposed to rain or moisture, does not operate normally, or has been dropped.
- Do not expose this apparatus to drips or splashes.
  - Do not place any objects filled with liquids, such as vases, on the apparatus.
  - Do not install this apparatus in a confined space such as a book case or similar unit.
  - The apparatus draws nominal non-operating power from the AC outlet with its POWER or STANDBY/ON switch not in the ON position.
  - The apparatus should be located close enough to the AC outlet so that you can easily grasp the power cord plug at any time.
  - The mains plug is used as the disconnect device; the disconnect device shall remain readily operable.
  - If the product uses batteries (including a battery pack or installed batteries), they should not be exposed to sunshine, fire or excessive heat.
  - CAUTION for products that use replaceable lithium batteries: there is danger of explosion if a battery is replaced with an incorrect type of battery. Replace only with the same or equivalent type.
  - Caution should be taken when using earphones or headphones with the product because excessive sound pressure (volume) from earphones or headphones can cause hearing loss.
  - If you are experiencing problems with this product, contact TEAC for a service referral. Do not use the product until it has been repaired.

# IMPORTANT SAFETY INFORMATION

## CAUTIONS ABOUT BATTERIES

This product uses batteries. Misuse of batteries could cause a leak, rupture or other trouble. Always abide by the following precautions when using batteries.

- Never recharge non-rechargeable batteries. The batteries could rupture or leak, causing fire or injury.
- When installing batteries, pay attention to the polarity indications (plus/minus (+/-) orientation), and install them correctly in the battery case as indicated. Putting them in backward could make the batteries rupture or leak, causing fire, injury or stains around them.
- When throwing used batteries away, follow the disposal instructions indicated on the batteries and the local disposal laws.
- Do not use batteries other than those specified. Do not mix and use new and old batteries or different types of batteries together. The batteries could rupture or leak, causing fire, injury or stains around them.
- Do not carry or store batteries together with small metal objects. The batteries could short, causing leak, rupture or other trouble.
- Do not heat or disassemble batteries. Do not put them in fire or water. Batteries could rupture or leak, causing fire, injury or stains around them.
- If the battery fluid leaks, wipe away any fluid on the battery case before inserting new batteries. If the battery fluid gets in an eye, it could cause loss of eyesight. If fluid does enter an eye, wash it out thoroughly with clean water without rubbing the eye and then consult a doctor immediately. If the fluid gets on a person's body or clothing, it could cause skin injuries or burns. If this should happen, wash it off with clean water and then consult a doctor immediately.
- The unit power should be off when you install and replace batteries.
- Remove the batteries if you do not plan to use the unit for a long time. Batteries could rupture or leak, causing fire, injury or stains around them. If the battery fluid leaks, wipe away any fluid on the battery case before inserting new batteries.

## 产品有毒有害物质或元素的名称及含量

机种: DP-008		有毒有害物质或元素					
	品名	铅 (Pb)	汞 (Hg)	镉 (Cd)	六价铬 (Cr(VI))	多溴联苯 (PBB)	多溴二苯醚 (PBDE)
1	CHASSIS部份	○	○	○	○	○	○
2	PCB Assy部份	×	○	○	○	○	○
3	线材部份	○	○	○	○	○	○
4	附属品部份	×	○	○	○	○	○
7	SEAL部份	○	○	○	○	○	○
8	包装部份	○	○	○	○	○	○

○: 表示该有毒有害物质在该部件所有均质材料中的含有量均在 SJ/T11363-2006 标准规定的限量要求以下。

×: 表示该有毒有害物质至少在该部件的某一均质材料中的含量超出 SJ/T11363-2006 标准规定的限量要求。

(针对现在代替技术困难的电子部品及合金中的铅)



# Table of Contents

<b>1 – Introduction</b> .....	<b>7</b>	Rear panel connections .....	34
Overview of this unit.....	7	Right side panel connections.....	34
About this manual .....	7	Adjusting the contrast.....	34
Manual conventions .....	7	Setting the backlight.....	35
Product parts .....	7	<b>5 – Song Management</b> .....	<b>36</b>
Intellectual property rights .....	8	Partitions and songs .....	36
About SD cards .....	8	Selecting the active partition .....	36
Precautions for use.....	8	Editing names .....	37
Cautions on installation .....	9	Loading a saved song .....	37
Beware of condensation .....	9	Creating a new song .....	37
Cleaning the unit.....	9	Saving a song.....	38
<b>2 – Quick Start Guides</b> .....	<b>10</b>	Viewing song information .....	38
Playback and mixing .....	10	Copying songs.....	38
Preparing to listen to the demo song..	10	Erasing songs .....	39
Playing and mixing the demo song .....	11	Protecting songs .....	40
From recording to creating a master track	13	<b>6 – Basic Recording</b> .....	<b>41</b>
Creating a new song .....	13	Selecting the input source .....	41
Connecting and setting the input	14	Phantom power.....	41
sources .....	14	Monitoring input signals.....	42
Setting the guitar as TRACK 1	15	About the OL indicators and level meters	42
recording source.....	15	Assigning inputs .....	43
Adjusting the input level and	15	Using input EQ .....	43
monitoring.....	15	Making the first recording .....	44
Recording guitar to TRACK 1.....	16	Multitrack recording .....	45
Listening to your recording.....	16	REC indicator settings .....	45
Record guitar to TRACK 2.....	17	Track pan and level settings.....	45
Record vocals on TRACK 3 .....	18	Input selection and assignment .....	45
Mixing the tracks.....	20	Input level settings .....	45
Mastering the mix .....	20	Making additional recordings .....	45
Shutting down the unit .....	23	Mixdown.....	45
<b>3 – Names and Functions of Parts</b> .....	<b>24</b>	Level and balance.....	45
Top panel .....	24	Stereo position (panning).....	45
Front panel.....	26	Track EQ (equalizer) .....	45
Rear panel.....	27	Reverb .....	46
Right side panel .....	28	Muting tracks .....	47
Bottom panel .....	29	Mastering.....	48
Home Screen.....	30	Setting the end point.....	48
<b>4 – Preparations</b> .....	<b>31</b>	Recording the master track .....	48
Preparing the power and SD card .....	31	Undoing operations (undo).....	49
Installing an SD card.....	31	Undoing the last operation	
Preparing the power.....	31	(single undo) .....	50
Connecting an AC adaptor (sold	32	Undoing a previous operation	
separately).....	32	(multi-undo) .....	50
Start-up & shutdown.....	32	Erasing the operation history .....	51
Starting up the unit .....	32	<b>7 – Recorder Functions</b> .....	<b>52</b>
Shutting down.....	32	Punching in and out.....	52
Formatting SD cards .....	33	Using the foot switch to punch in/out	52
Recorder modes .....	33	Setting the foot switch polarity .....	52
Connecting with other equipment.....	34	Bouncing tracks .....	53
		Using the bounce function .....	53

# Table of Contents

Confirming the result.....	53	Disconnecting.....	72
Locate and search functions .....	54	Song backup and restoration.....	73
Direct locate function.....	54	Backing-up songs.....	73
Return To Zero (RTZ) and		Restoring songs.....	74
Last Recording Position (LRP) .....	54	Track import and export .....	74
Fast forward/rewind search .....	55	Importing tracks.....	75
Repeat playback.....	55	Exporting tracks .....	76
Setting IN and OUT points .....	55	Exporting a stereo master track.....	77
Editing IN/OUT points .....	55		
Using repeat playback.....	56	<b>12 – Troubleshooting .....</b>	<b>78</b>
Setting the interval between		<b>13 – Messages .....</b>	<b>79</b>
repetitions .....	56	<b>14 – Specifications and Block</b>	
Locating to the IN or OUT point .....	56	<b>Diagram .....</b>	<b>81</b>
Automatically punching in and out .....	56	Audio input/output ratings.....	81
Rehearsal .....	56	Audio performance .....	81
Using auto punch in/out to record .....	57	General.....	81
		Optional accessories .....	82
<b>8 – Editing Tracks .....</b>	<b>58</b>	Computer requirements.....	82
Overview of track editing.....	58	Backup memory.....	82
Editing points .....	58	Dimensions.....	83
Basic editing procedures .....	58	Block diagram .....	83
Explanation of items.....	59		
COPY/PASTE .....	60	<b>15 – Commonly-used Functions ....</b>	<b>84</b>
COPY/INSERT .....	60		
MOVE/PASTE .....	61		
MOVE/INSERT .....	61		
OPEN (insert silence) .....	61		
CUT (remove part) .....	62		
SILENCE (part erase) .....	62		
CLONE track (track duplication).....	62		
CLEAN out (track erase).....	63		
<b>9 – Miscellaneous Functions.....</b>	<b>64</b>		
Metronome .....	64		
Tuner .....	64		
Chromatic tuner mode .....	64		
Oscillator mode .....	65		
Turning the power off automatically.....	66		
Restoring the initial preference settings ..	66		
Viewing information .....	66		
<b>10 – SD Card Management.....</b>	<b>68</b>		
Overview of partitions .....	68		
Formatting cards and setting			
partition sizes.....	68		
Reformatting MTR partitions .....	69		
Reformatting the FAT partition .....	70		
Initializing SD cards.....	70		
<b>11 – Exchanging Data with a</b>			
<b>Computer.....</b>	<b>71</b>		
Supported operating systems .....	71		
Connecting with a computer .....	71		

# 1 – Introduction

Thank you for your purchase of TASCAM's 8-Track Digital Pocketstudio, the DP-008.

The DP-008 is designed to provide you with great sound in an easy-to-use compact package, allowing you to concentrate on the music, and not on the recording process.

Before connecting and using the unit, please take time to read this manual thoroughly to ensure you understand how to properly set up and connect the unit, as well as the operation of its many useful and convenient functions. After you have finished reading this manual, please keep it in a safe place for future reference.

You can also download the Owner's Manual from the TASCAM web site (<http://www.tascam.com>).

---

## Overview of this unit

---

Using an SD card this unit can record two tracks simultaneously and work with up to eight tracks in a multitrack project. Moreover, using its mixer functions, you can mix down a multitrack to create a stereo master track.

This stereo master track can then be transferred to a computer connected by USB. In addition to copying stereo master tracks from this unit to the computer, various other data, including track and song data can be transferred to a computer as back-ups.

---

## About this manual

---

Please read chapter 2, "Quick Start Guides," first and follow the instructions in it to learn about and practice using this unit's functions.

Chapter 3 explains the functions of the keys, knobs, connectors and other features. Chapters 4 and 5 explain other things you should know before you use this unit. Chapters 6 to 11 explain the uses and functions of this unit in detail. Chapters 12 and 13 provide troubleshooting information and a list of messages. Chapter 14 includes the unit's specifications and block diagram. Chapter 15 provides functions that you might want to use and where you can find them in the manual

---

## Manual conventions

- This manual often refers to the DP-008 as "the unit" and the SD card as the "card."
- When we refer to DP-008 features such as keys and connections, we display them like this: **MENU**.
- When we show messages, for example, that appear on the screen, we show them like this: **SONG LOAD**.
- The four keys beneath the LCD display are called function keys, and are referred to as **F1**, **F2**, **F3** and **F4** from left to right. The functions displayed at the bottom of the screen above the keys are sometimes shown after the key name in parentheses (e.g. **F4** (▶) key, **F2** (E×E) key).
- Additional information is introduced in the styles below when needed:

### TIP

*We give hints and tips on using the DP-008 when you see this icon.*

### NOTE

*A note provides additional explanations for special situations.*

### CAUTION

*A caution shows that you may lose data (recordings) if you do not follow the instructions.*

This manual cannot begin to be a full guide to multitrack recording techniques. However, if you search the Internet or visit a library you should find various documents on recording.

---

## Product parts

---

The DP-008 package contains the following items.

Take care when opening the package not to damage the items. Keep the package materials for transportation in the future.

Please contact the store where you purchased this unit if any of these items are missing or have been damaged during transportation.

# 1 – Introduction

- Main unit ..... 1
- SD Card (in the unit) ..... 1
- USB Cable ..... 1
- AA alkaline batteries ..... 4
- Warranty card ..... 1
- Owner's Manual (this document) ..... 1

---

## Intellectual property rights

---

- TASCAM is a registered trademark of TEAC Corporation.
- SDHC logo is a trademark.



- Microsoft, Windows, Windows Vista, and Windows 7 are either registered trademarks or trademarks of Microsoft Corporation in the United States and/or other countries.
- Apple, Macintosh, Mac OS and Mac OS X are trademarks of Apple Inc.
- Other company names, product names and logos in this document are the trademarks or registered trademarks of their respective owners.

Any data, including, but not limited to information, described herein are intended only as illustrations of such data and/or information and not as the specifications for such data and/or information. TEAC Corporation disclaims any warranty that any use of such data and/or information shall be free from infringement of any third party's intellectual property rights or other proprietary rights, and further, assumes no liability of whatsoever nature in the event of any such infringement, or arising from or connected with or related to the use of such data and/or information.

This product is designed to help you record and reproduce sound works to which you own the copyright, or where you have obtained permission from the copyright holder or the rightful licensor. Unless you own the copyright, or have obtained the appropriate permission from the copyright holder or the rightful licensor, your unauthorized recording, reproduction or distribution thereof may result in severe criminal penalties under copyright laws and international copyright treaties. If you are uncertain about your rights, contact your legal advisor. Under no circumstances will TEAC Corporation be responsible for the consequences of any illegal copying performed using the recorder.

---

## About SD cards

---

This unit uses SD cards for recording and playback. SD and SDHC cards that are at least 512 MB in size can be used. A list of SD cards that have been tested with this unit can be found on the TASCAM web site ([www.tascam.com](http://www.tascam.com)).

---

## Precautions for use

---

SD cards are delicate media. In order to avoid damaging a card or the card slot, please take the following precautions when handling them.

- Do not leave them in extremely hot or cold places.
- Do not leave them in extremely humid places.
- Do not let them get wet.
- Do not put things on top of them or twist them.
- Do not hit them.

---

## Cautions on installation

---

- The unit's nominal operating temperature is between 5° and 35° C (41° – 95° F).
- Do not install in the following types of places. Doing so could degrade the sound quality and/or cause malfunctions.
  - Places with significant vibrations or that are otherwise unstable
  - Near windows or other places exposed to direct sunlight
  - Near heaters or other extremely hot places
  - Extremely cold places
  - Places with bad ventilation or high humidity

---

## Beware of condensation

---

If the unit is moved from a cold to a warm place, or used after a sudden temperature change, there is a danger of condensation; vapor in the air could condense on the internal mechanism, making correct operation impossible. To prevent this, or if this occurs, let the Pocketstudio sit for one or two hours at the new room temperature before using.

---

## Cleaning the unit

---

To clean the unit, wipe gently with a soft dry cloth. Do not use any benzene, paint thinner, ethyl alcohol or other chemical agents to clean the unit as they could damage the surface.

# 2 – Quick Start Guides

## Playback and mixing

First, we will play the demo song on the included SD card. The SD card with the demo song is shipped already installed but we will start by explaining how to insert an SD card here.

### Preparing to listen to the demo song

- 1 Open the SD card slot cover on the right side of the unit and insert the supplied SD card into the slot.

Do not insert the card backwards or apply unnecessary force. This could damage the slot or card.

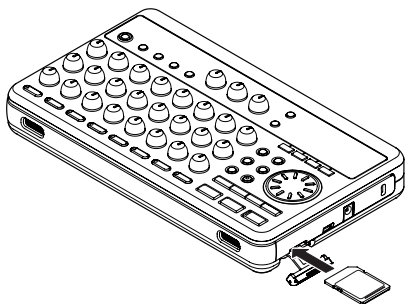

- 2 Close the slot cover.
- 3 Open the battery compartment cover and insert four AA batteries into the compartment, paying attention to the plus/minus (+/-) orientation. This unit can use alkaline or NiMH batteries.

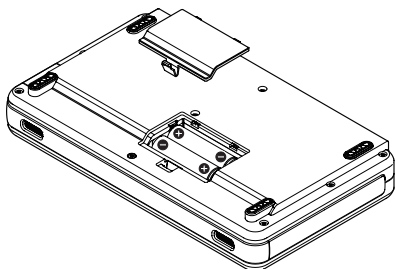

- 4 Close the battery compartment cover after installing the batteries.
- 5 Connect headphones to the PHONES connector.

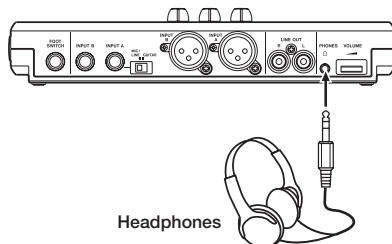

- 5 Press and hold the STANDBY/ON key on the top panel until TASCAM appears on screen.

After starting up the Home Screen appears on the display.

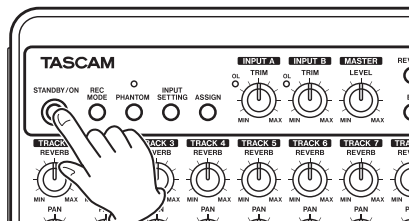

[Start-Up Screen]



[Home Screen]

### CAUTION

- Do not remove or insert the SD card when the unit's power is ON. Make sure the unit power is OFF before you remove

## 2 – Quick Start Guides

or insert the card. If you remove or insert the SD card when the unit's power is on, the unit cannot shut down properly and all unsaved data and settings will be lost. These data and settings cannot be recovered.

- Do not remove the batteries or disconnect the power cable while the unit power is ON.
- The included alkaline batteries are for confirming operation of the unit and might not last very long.
- Before turning the power ON, completely turn down the volume of headphones and monitoring systems connected to the unit.

### TIP

- This unit can also be powered by a PS-P520 power adaptor (sold separately) (see "Connecting an AC adaptor (sold separately)" on page 32).
- You can monitor recordings using speakers by connecting an amplifier or powered speakers to the LINE OUT jacks.

## Playing and mixing the demo song

Before the unit is shipped, a demo song is stored on its SD card. We are now going to use basic playback and mixing features with this demo song.

- 1 Press the HOME key to open the Home Screen.

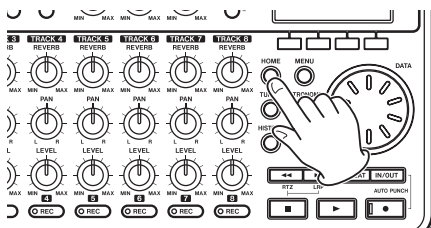

- 2 When the Home Screen is open, press the MENU key to open the MENU screen.

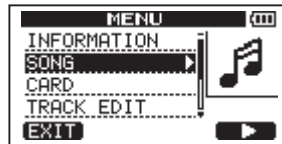
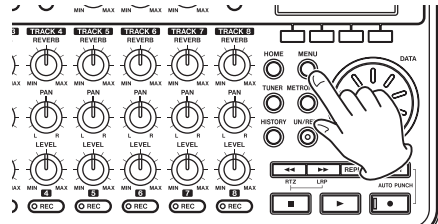

- 3 Use the DATA wheel to select the SONG menu, and press the F4 (▶) key to open the SONG menu screen.

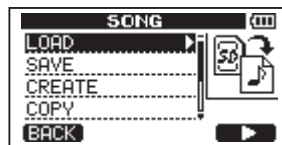
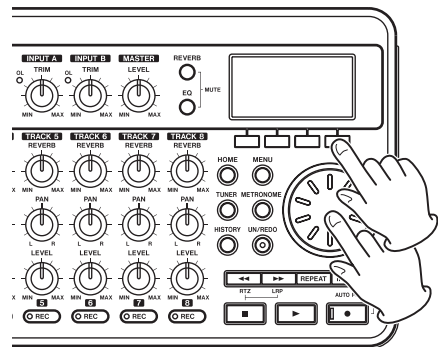

- 4 Rotate the DATA wheel to select LOAD, and press the F4 (▶) key to open the SONG LOAD screen that shows a list of songs.

# 2 – Quick Start Guides

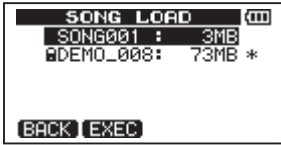

- 5 Rotate the DATA wheel to select DEMO\_008, and press the F2 (EXEC) key.

The demo song loads and the SONG screen reopens.

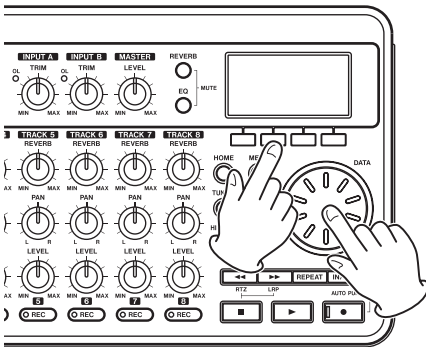

- 6 Press the HOME key to reopen the Home Screen.

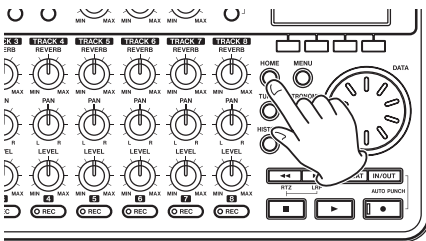

- 7 Press the playback (▶) key and turn up the TRACK1–8 LEVEL knobs, the MASTER LEVEL knob and the VOLUME dial to hear the demo song.

The MASTER LEVEL knob adjusts the

volume of all eight tracks at the same time. The standard position is around 2–3 o'clock.

Use the LEVEL knobs to adjust the balance between TRACK 1–8.

Use the VOLUME dial to adjust the final monitoring level.

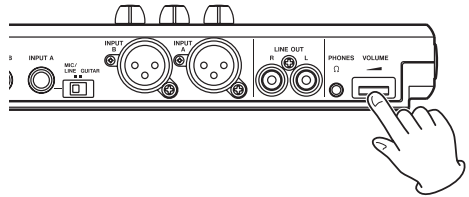
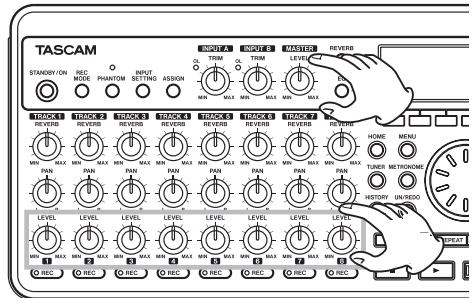

- 8 Use the PAN knobs to adjust the stereo position of TRACK 1–8.

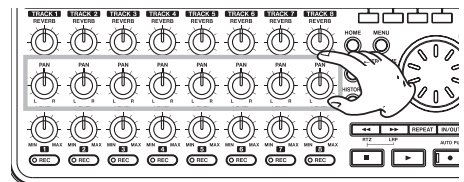

## TIP

- Press the stop (■) key and the ◀◀ key at the same time to use the RTZ (return to zero) function to go to the beginning of the song.
- When using a menu, if you make a mistake pressing a key and the wrong screen appears, press the HOME key to return to the Home Screen.



# 2 – Quick Start Guides

## From recording to creating a master track

Here, we will try multitrack recording. In the following example, we will use an electric guitar to record a rhythm guitar part on track 1 and a lead guitar part on track 2. Then, we will use the built-in mic to record a voice on track 3. Finally, we will mix the tracks down.

In this section, we assume that you have already followed the instructions in “Playback and mixing” to connect monitoring equipment and install the SD card.

### TIP

*This example uses the built-in mic for recording vocals, but you could also connect an external mic to the INPUT A or INPUT B connector on the rear panel and record it.*

## Creating a new song

- 1 When the recorder is stopped, press the MENU key to open the MENU screen.

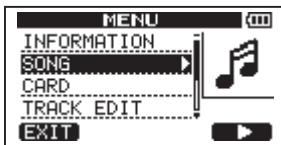
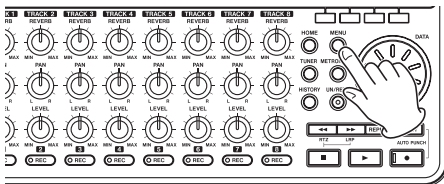

- 2 Use the DATA wheel to select the SONG menu, and press the F4 (▶) key to open the SONG menu screen.

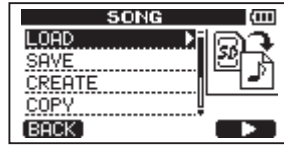
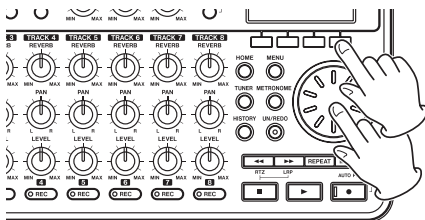

- 3 Use the DATA wheel to select CREATE, and press the F4 (▶) key to open the SONG CREATE screen.

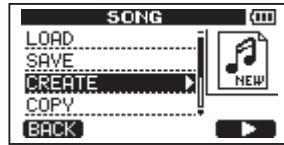

When a new song is created, it is given the name “SONG\*\*\*” (where \*\*\* is a number).



- 4 Change the song name as necessary. (See “Editing names” on page 37.)
- 5 Press the F2 (EXEC) key. The currently loaded song is saved and a new song is created.

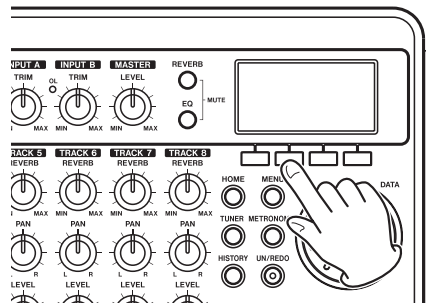

- 6 Press the HOME key to return to the Home Screen.

# 2 – Quick Start Guides

## Connecting and setting the input sources

- 1 Connect an electric guitar to the INPUT A connector on the rear panel.

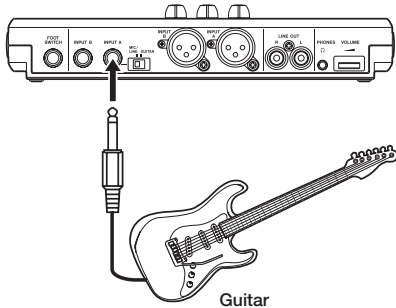

- 2 Set the MIC/LINE-GUITAR switch on the rear panel to GUITAR.

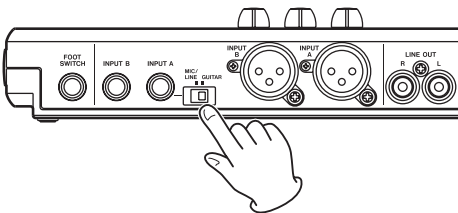

### TIP

When connecting an electric-acoustic guitar with a built-in preamp or an active electric guitar, as well as when connecting an electric guitar with effect boxes between it and this unit, set the MIC/LINE-GUITAR switch to MIC/LINE.

- 3 Press the INPUT SETTING key to open the INPUT SETTING screen.

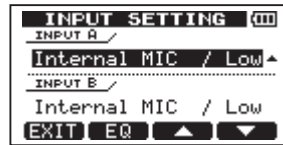
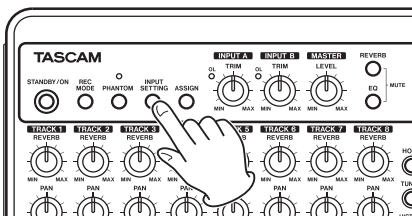

On this screen you can set the input sources for both INPUT A and INPUT B.

At first, the input source for INPUT A is already selected.

- 4 Use the DATA wheel to change the INPUT A input source to Ext.Input, LINE/ Low.

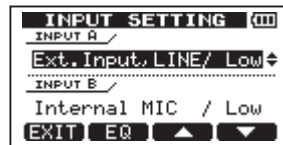
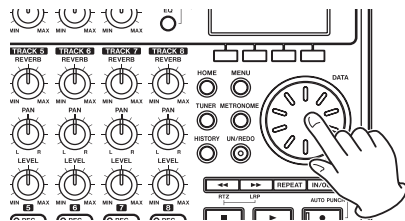

- 5 Press the F4 (▼) key to select the current input for INPUT B.

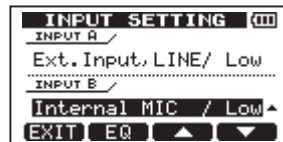
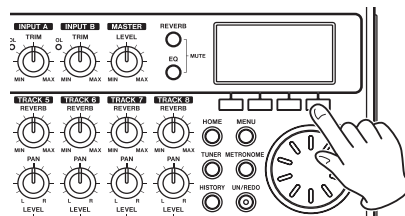

- 6 Use the DATA wheel to set the INPUT B input source to Internal MIC / Low or Internal MIC / High.

## 2 – Quick Start Guides

This sets MIC B, which is the built-in mic on the right side of the front panel as the input source for INPUT B.

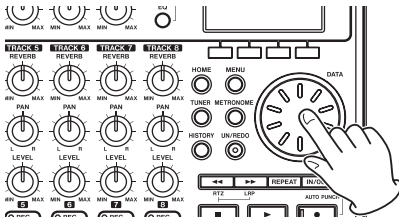

### NOTE

*Internal MIC / Low and Internal MIC / High change the sensitivity of the built-in mics. Set it according to the loudness of the subject being recorded.*

*If you are not sure which setting to use, choose Internal MIC / Low. If the input level is too low after adjusting it later, return to this screen and change the setting to Internal MIC / High.*

- 7 After changing the setting, press the HOME key to return to the Home Screen.

### Setting the guitar as TRACK 1 recording source

The default settings are for the INPUT A to be the recording source for TRACK 1, 3, 5 and 7 and for the INPUT B to be the recording source for TRACK 2, 4, 6 and 8.

In “Connecting and setting the input sources” above, we made a guitar the input source for the INPUT A and a built-in mic (MIC B) the input source for the INPUT B. Therefore, the guitar is already set to record to TRACK 1, 3, 5 and 7 and MIC B is ready to record to TRACK 2, 4, 6 and 8.

As a result, there is no need to change the input channel assignments to record the guitar

to TRACK 1 in this example.

### Adjusting the input level and monitoring

- 1 Press the HOME key to return to the Home Screen.

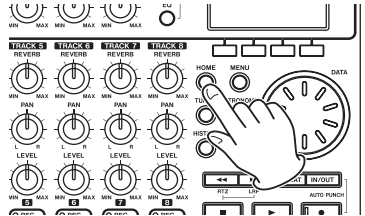

- 2 Press the TRACK 1 REC key. The key blinks showing that the track is in record standby.

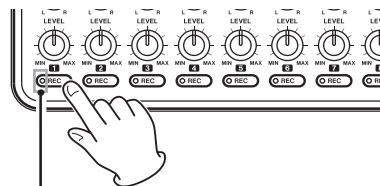

TRACK 1 REC indicator

- 3 Use the INPUT A TRIM knob to adjust the guitar input level.

Set the TRIM knob so that the INPUT A OL indicator does not light even when the loudest sound to be recorded is input. If the indicator continues to light even when the TRIM knob is turned down, the guitar signal itself is too loud. In this case, lower the output level on the guitar.

# 2 – Quick Start Guides

## OL indicator

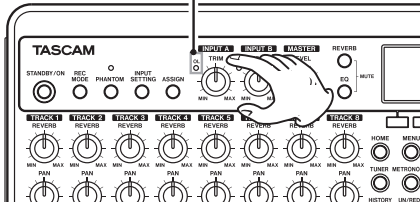

When you play the guitar, the input level is shown by the **A** (INPUT A) and **1** (TRACK 1) meters on the display.



Turn up the **TRACK 1 LEVEL** and **MASTER LEVEL** knobs and the **VOLUME** dial to hear the guitar sound through headphones. When doing so, the **L** and **R** meters on the right side of the display become active.

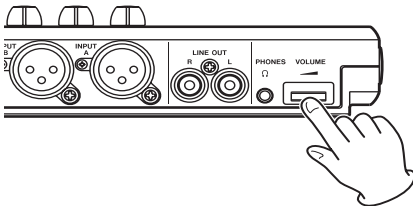
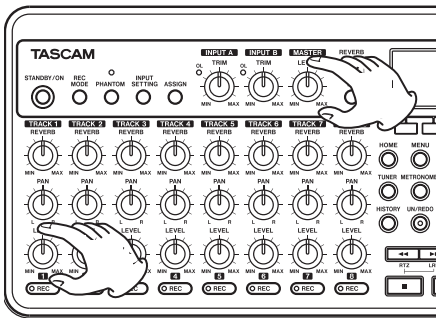

## NOTE

- You can use the **TRACK 1 PAN** knob to adjust the stereo position of the signal when monitoring.
- The input signal cannot be monitored if the **REC** indicator of the **TRACK 1** that it is assigned to is not lit.

## Recording guitar to TRACK 1

- 1 Press the playback (**▶**) key while pressing and holding the record (**●**) key to start recording. The **TRACK 1 REC** key stops blinking and stays lit constantly.

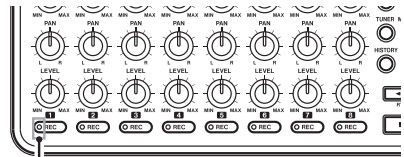

TRACK 1 REC indicator

You are recording. Play your guitar!

- 2 When you are finished, press the stop (**■**) key to stop recording.
- 3 Press the **TRACK 1 REC** key again. Its light turns off.

## Listening to your recording

- 1 To go to the beginning of the song, press the **◀◀** key while pressing and holding the stop (**■**) key. (This is the Return To Zero (RTZ) function)
- 2 Press the playback (**▶**) key to play the recorded track.
- 3 Use the **TRACK 1 LEVEL** knob and the **MASTER LEVEL** knob to adjust the playback level. Use the **VOLUME** dial to adjust the final monitoring volume.

# 2 – Quick Start Guides

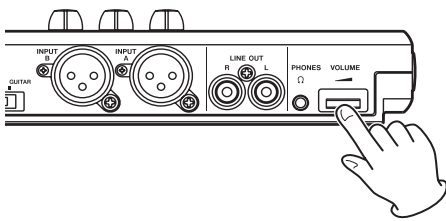
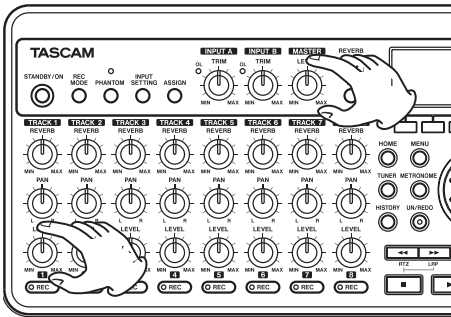

### TIP

Use the TRACK 1 PAN knob to set the stereo position of the track signal.

## Record guitar to TRACK 2

Now, you will record lead guitar on TRACK 2 while listening to the rhythm guitar on TRACK 1. Use the following procedures to change the recording source for TRACK 2.

- 1 Press the ASSIGN key to open the INPUT ASSIGN screen.

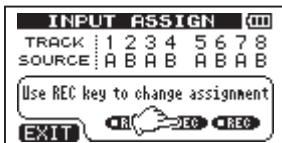
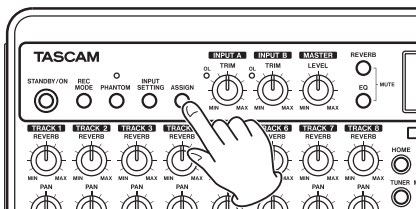

Set which input (INPUT A or INPUT B) is to be the recording source for each track. In the initial setting, INPUT A (A) is assigned as the recording source for tracks 1, 3, 5 and 7, and INPUT B (B) is assigned as the recording source for tracks 2, 4, 6 and 8.

- 2 Press the TRACK 2 REC key to set the TRACK 2 SOURCE to A.

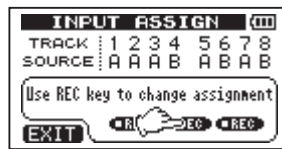
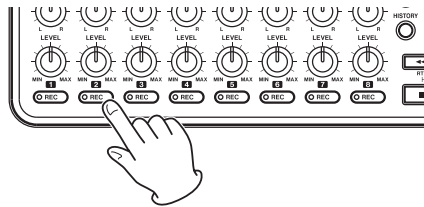

- 3 Press the HOME key to return to the Home Screen.

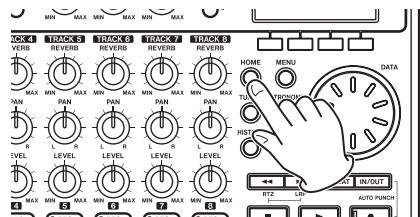

- 4 Press the TRACK 2 REC key. The key blinks showing that the track is in record standby.

When you play the guitar, the input level is shown by the A (INPUT A) and 2 (TRACK 2) meters on the display.

# 2 – Quick Start Guides

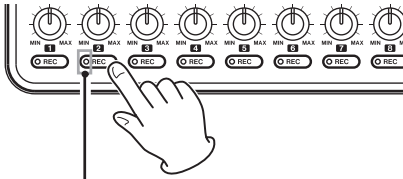

TRACK 2 REC indicator



- Return to the beginning of the song and begin playback. Play the lead guitar part along with the already recorded rhythm guitar.

Raise the TRACK 2 LEVEL knob to hear the sound of the guitar being input along with the TRACK 1 playback sound through the headphones.

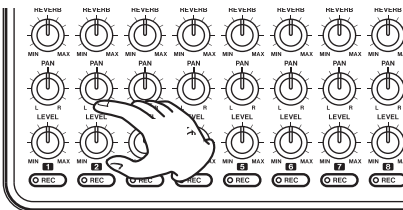

- Use the TRACK 1 and 2 LEVEL and PAN knobs, the MASTER LEVEL knob and the VOLUME dial as necessary to adjust the monitoring levels and balance.

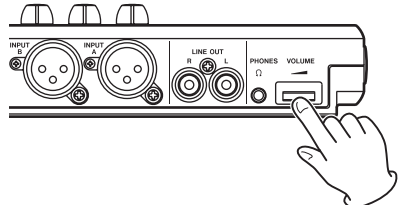
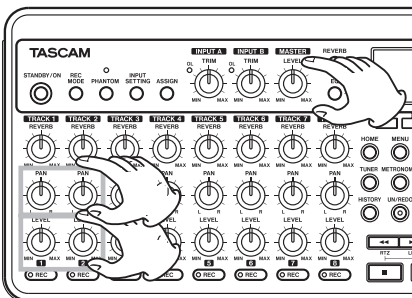

- Return to the start of the song again and press the playback (▶) key while pressing and holding the record (●) key to start recording. The TRACK 2 REC key stops blinking and stays lit constantly.

You are recording again. Play your guitar!

- When you are finished, press the stop (■) key to stop recording.
- Press the TRACK 2 REC key again. Its light turns off.

## Record vocals on TRACK 3

- Press ASSIGN to open the INPUT ASSIGN screen.

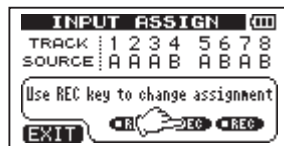
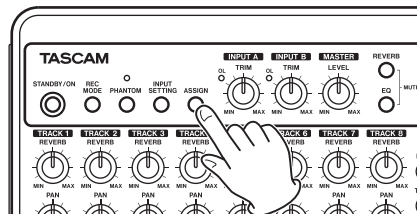

- Press the TRACK 3 REC key to set the TRACK 3 SOURCE to B.

## 2 – Quick Start Guides

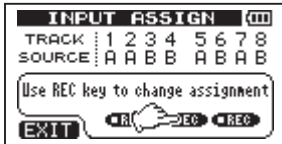
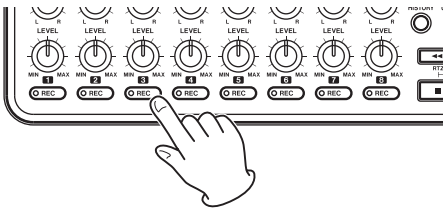

- 3 Press the HOME key to return to the Home Screen.

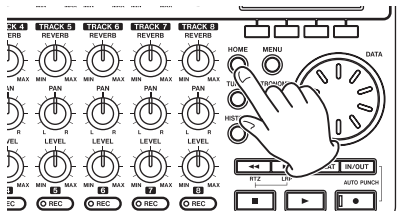

- 4 Press the TRACK 3 REC key. The key blinks showing that the track is in record standby.

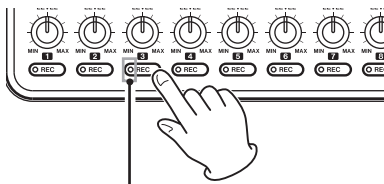

TRACK 3 REC indicator

- 5 Use the INPUT B TRIM knob to adjust the mic input level. Set the TRIM knob so that the INPUT B OL indicator does not light even when the loudest sound to be

recorded is input.

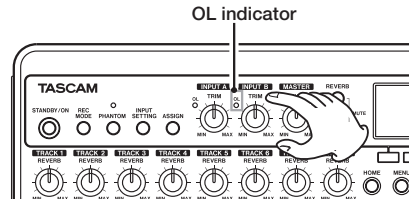

The input level of built-in MIC B is shown by the B meter on the screen.



Raise the TRACK 3 LEVEL knob, MASTER LEVEL knob and VOLUME dial as necessary to hear the mic input through the headphones.

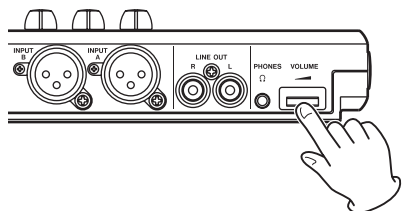
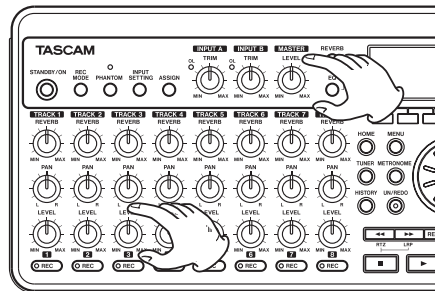

### NOTE

If the OL indicator continues to light even when the TRIM knob is turned down, the mic signal itself is too loud. In this case,



# 2 – Quick Start Guides

if the input setting is Internal MIC / High, change it to Internal MIC / Low. If the OL indicator continues to light even when set to Internal MIC / Low, move the sound source away from the mic or lower the volume at the sound source.

### CAUTION

Always monitor through headphones when using a mic. If you monitor through speakers, feedback could occur.

- 6 Return to the beginning of the song and begin playback. Sing along with the already recorded rhythm and lead guitar parts.

You can hear the playback of TRACK 1 and TRACK 2 as well your singing through the headphones.

- 7 Use the TRACK 1 and TRACK 2 LEVEL and PAN knobs, MASTER LEVEL knob and VOLUME dial to adjust the output volume and the balance between the tracks.

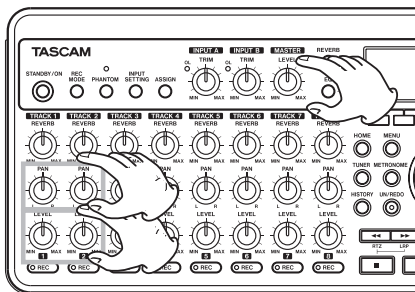

- 8 Return to the start of the track again and press the playback (▶) key while pressing and holding the record (●) key to start recording. The TRACK 3 REC key stops blinking and stays lit constantly.

You are recording again. Sing!

- 9 When you are finished, press the stop (■) key to stop recording.
- 10 Press the TRACK 3 REC key again. Its light turns off.

## Mixing the tracks

After you finish recording, the next step is to make a stereo mix.

- 1 Use the LEVEL knobs for TRACK 1, 2 and 3, to adjust the levels of the tracks and the balance between them. Use the MASTER LEVEL knob to adjust the overall level.
- 2 Use the track PAN knobs to adjust the stereo positioning of the tracks.

Watch the L and R meters at the right side of the display as you adjust levels and panning.

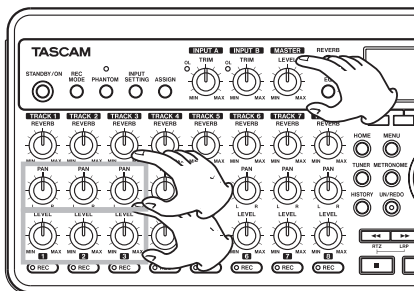

## Mastering the mix

Now we will record your stereo mix. We call this process mastering.

The time between the song's beginning (00:00:00) and the OUT point will be recorded as the stereo master track. So, first we must set the OUT (end) point.

- 1 Press the IN/OUT key to open the I/O SETTING screen.

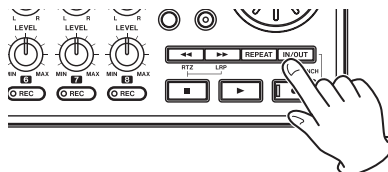





# 2 – Quick Start Guides



- 7 Press the playback (▶) key while pressing and holding the record (●) key to start master recording. Recording automatically ends when the recorder position reaches the OUT point.

**NOTE**

You can use the LEVEL knobs to adjust the track and overall levels as you record.

- 8 Press the REC MODE key to open the RECORDER MODE screen.

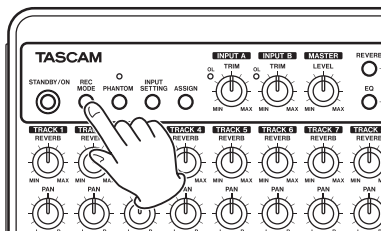

- 9 Turn the DATA wheel to select MASTER PLAY.

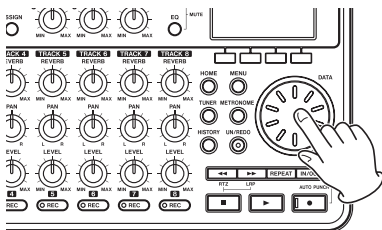

- 10 Press the F4 (EXEC) key to put this unit into master playback mode and return to the Home Screen.

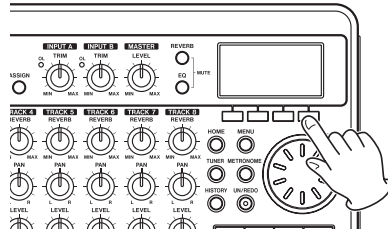

- 11 Press the playback (▶) key to play the stereo master track that you created.

**NOTE**

In MASTER PLAY mode, you cannot adjust the level with the MASTER LEVEL knob.

## 2 – Quick Start Guides

### Shutting down the unit

Shutdown the unit when you are finished.

- 1 Press the HOME key to return to the Home Screen.

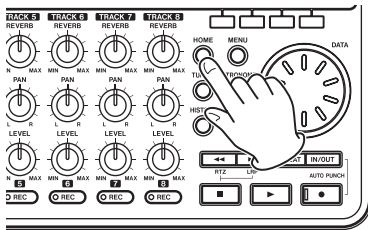

*shut down properly and all unsaved data will be lost. Lost data cannot be restored. We recommend that you also save the data manually often.*



- 2 Press and hold the STANDBY/ON key until **POCKETSTUDIO** appears on the screen.

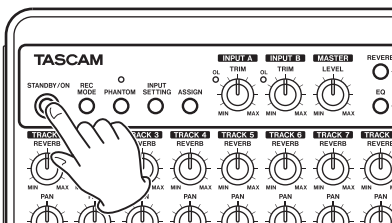

The power turns off after the unit completes its shutdown process, including saving various information from your session.

#### CAUTION

*Do not remove the batteries or disconnect the power cable accidentally while the unit is operating. If you do so, the unit cannot*

# 3 – Names and Functions of Parts

## Top panel

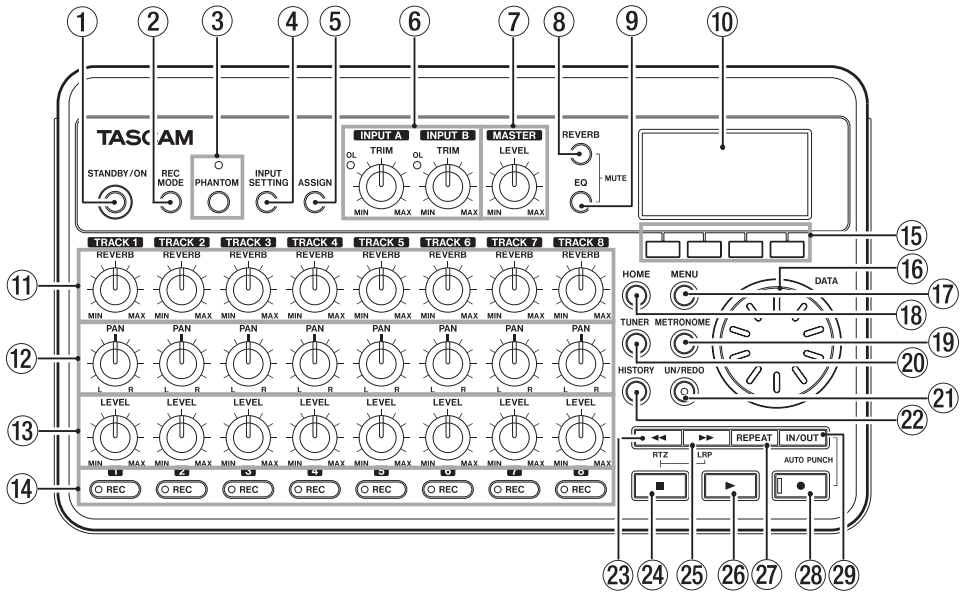

- 1 STANDBY/ON key**  
Press and hold this key to turn the unit ON and OFF. (See “Start-up & shutdown” on page 32.)
- 2 REC MODE key**  
Use this key to set the recorder mode. Select between MULTI TRACK, BOUNCE, MASTER REC and MASTER PLAY. (See “Recorder modes” on page 33.)
- 3 PHANTOM key and indicator**  
Press this key to open the phantom power setting screen. When the phantom power is on, the indicator lights.
- 4 INPUT SETTING key**  
Press this key to select the input source. (See “Selecting the input source” on page 41.)
- 5 ASSIGN key**  
Use this to set (assign) the input (INPUT A, INPUT B) for each track. Press this key to open the INPUT ASSIGN screen on the display. The input signal of the input assigned to a track becomes the track’s recording source. (See “Assigning inputs” on page 43.)
- 6 INPUT A and INPUT B TRIM knobs and OL indicators**  
Use these knobs to adjust the input levels for INPUT A and INPUT B. (See “Making the first recording” on page 44.)  
If the input source level is too high its OL (overload) indicator lights.
- 7 MASTER LEVEL knob**  
Adjusts the monitoring level of the stereo output signal.  
This knob also adjusts the recording level when performing a bounce, mix down or mastering.
- 8 REVERB key**  
Press this key to open the reverb setting screen. (See “Reverb” on page 46.)  
Press this key and EQ key at the same time to open the TRACK MUTE screen. (See “Muting tracks” on page 47.)

# 3 – Names and Functions of Parts

- ⑨ **EQ key**  
Press this key to open the track EQ setting screen. (See “Track EQ (equalizer)” on page 45.)  
Press this key and **REVERB** key at the same time to open the **TRACK MUTE** screen. (See “Muting tracks” on page 47.)
- ⑩ **LCD Display**  
This shows various information.
- ⑪ **REVERB knobs (TRACK 1 - TRACK 8)**  
Use to adjust the amount (volume) of the track playback signal or assigned input signal that is sent to the reverb effect.
- ⑫ **PAN knobs (TRACK 1 - TRACK 8)**  
Use to adjust the stereo position of the track playback signal or assigned input signal. (See “Stereo position (panning)” on page 45.)
- ⑬ **LEVEL knobs (TRACK 1 - TRACK 8)**  
Use to adjust the monitoring level of the track playback signal or assigned input signal. (See “Level and balance” on page 45.)
- ⑭ **REC keys and indicators (TRACK 1 - TRACK 8)**  
Use to arm a track for recording (turn recording ON/OFF). To monitor a track’s input sound through headphones or a monitoring system, press that track’s **REC** key. When the **REC** key is ON, the **REC** indicator blinks while the unit is stopped and lights during recording.
- ⑮ **Function keys**  
The functions of these keys are shown at the bottom of the screen and depend on the current screen.
- NOTE**
- *In this manual, the four function keys are referred to as F1, F2, F3 and F4 in order from left and right.*
  - *The function keys have the following assignments on the Home Screen.*
    - Stop (■) + F1: Locate to the IN point*
    - Stop (■) + F2: Locate to the OUT point*
    - F3: Set the IN point*
    - F4: Set the OUT point*
- ⑯ **DATA wheel**  
Use this to change parameter values when using menus.
- ⑰ **MENU key**  
Press this key to open the MENU screen.
- ⑱ **HOME key**  
Press this key to open the Home Screen.  
When the unit is stopped and the Home Screen is open, this key is used to move between the time divisions in the counter. (See “Direct locate function” on page 54.)
- ⑲ **METRONOME key**  
Press this key to open the METRONOME setting screen. (See “Metronome” on page 64.)
- ⑳ **TUNER key**  
Press this key to open the TUNER screen. (See “Tuner” on page 64.)
- ㉑ **UN/REDO key and indicator**  
Press this to undo the last action. Press again to redo it. (See “Undoing operations (undo)” on page 49.)  
The **UN/REDO** indicator lights when single undo or multi-undo has been conducted and there are undone operations that can be redone.
- ㉒ **HISTORY key**  
Press this key to show the recording/editing history. Use this screen to undo multiple operations at the same time with the multi-undo function.
- ㉓ **◀◀/RTZ key**  
Press this key when the transport is stopped or playing to fast rewind. Press it again to change the speed from 10x to 50x, again for 100x and 1000x.  
If you press this key while holding down the stop (■) key, the transport will locate to the head of the song (RTZ). (See “Return To Zero (RTZ) and Last Recording Position (LRP)” on page 54.)
- ㉔ **Stop (■) key**  
Press this key alone to stop recording, playback, fast forward and fast rewind. If you press the ◀◀ or ▶▶ key at the same time, the transport will also

# 3 – Names and Functions of Parts

locate to the head of the song (RTZ) or the last recording start position (LRP). (See “Return To Zero (RTZ) and Last Recording Position (LRP)” on page 54.)

②5 **▶▶/LRP key**

Press this key when the transport is stopped or playing to fast forward. Press it again to change the speed from 10x to 50x, again for 100x and 1000x.

If you press this key while holding down the stop (■) key, the transport will locate to the last recording start position (LRP). (See “Return To Zero (RTZ) and Last Recording Position (LRP)” on page 54.)

②6 **Playback (▶) key**

Press this key to start playback. While pressing the record (●) key, press this key to start recording. Press this key again when recording to stop recording and start playback (punch out).

②7 **REPEAT key**

Turns the repeat playback mode on and off. (See “Repeat playback” on page 55.)

②8 **Record (●) key and indicator**

Press the playback (▶) key while pressing this key to start recording. The indicator lights when recording. If you press this key when any of the track **REC** indicators is blinking, or during playback, recording will begin (punch in). (See “Punching in and out” on page 52.)

Press the **IN/OUT** key while pressing and holding this key to enter auto punch in/out mode.

②9 **IN/OUT key**

Press this key to open the I/O **SETTING** screen, and to set **IN** (starting) and **OUT** (ending) points for repeat playback and track editing. (See “Setting **IN** and **OUT** points” on page 55.)

Press this key while pressing and holding the recording (●) key to enter auto punch in/out mode.

---

## Front panel

---

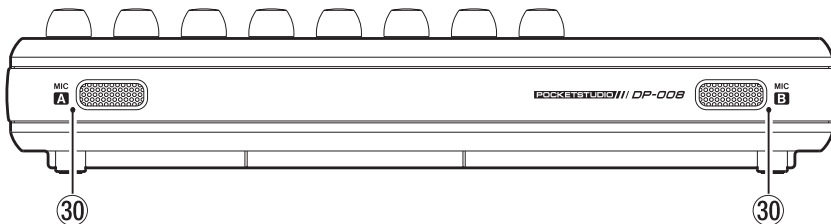

③0 **MIC A/B**

These are built-in omnidirectional microphones. They can be set as input sources for **INPUT A/B** (Internal MIC/Low or Internal MIC/High).

# 3 – Names and Functions of Parts

## Rear panel

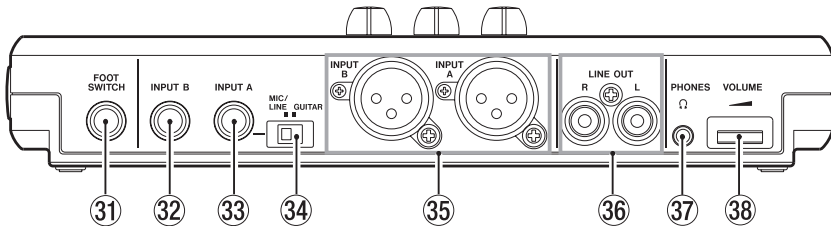

- 31 FOOT SWITCH jack**  
You can use a foot switch to punch in and out (start and stop recording).
- 32 INPUT B jack (1/4" phone jack)**  
Use this as the input source by setting INPUT B to external input ("Ext. Input") on the INPUT SETTING screen. You can use this jack for a line level or mic level signal (unbalanced connection).
- 33 INPUT A jack (1/4" phone jack)**  
Use this as the input source by setting INPUT A to Ext. Input (external input) on the INPUT SETTING screen. You can use this jack for a guitar/line level or mic level signal (unbalanced connection).  
Set the MIC/LINE-GUITAR switch according to the input source.
- 34 MIC/LINE-GUITAR switch**  
Set this switch to match the input signal to the INPUT A jack on the rear panel. For mic or line signals, set it to MIC/LINE. For electric guitars and basses that are connected directly, set it to GUITAR.
- 35 INPUT A/INPUT B jacks (XLR jacks)**  
Condenser microphones that require phantom power can receive it when they are connected to these jacks. (See "Phantom Power" on page 41.)  
(Pin assignments—1: ground, 2: hot, 3: cold)  
If devices are connected to both the XLR and the 1/4" phone jacks, the 1/4" phone jack is given precedence (the XLR connection is disabled).
- 36 LINE OUT jacks**  
Use these to connect a monitoring system (powered speakers or an amplifier with speakers).
- 37 PHONES jack**  
Connect headphones (with a stereo mini-plug connector) to this jack.
- 38 VOLUME dial**  
Use this to adjust the volume output from the PHONES connector.

# 3 – Names and Functions of Parts

## Right side panel

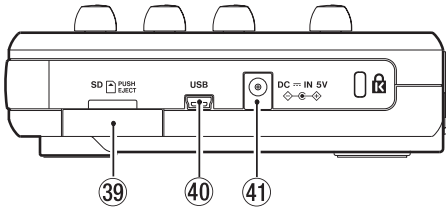

- ③⑨ **SD card slot**  
Insert an SD card into this slot.
- ④⑩ **USB port**  
Connect the unit to a computer using the included USB cable. This allows to sharing, importing and exporting files between the unit and the computer, including backup of the song data. (See “Connecting with a computer” on page 71.)
- ④① **DC  IN 5V connector**  
Connect a dedicated power adaptor (PS-P520, sold separately).



# 3 – Names and Functions of Parts

## Bottom panel

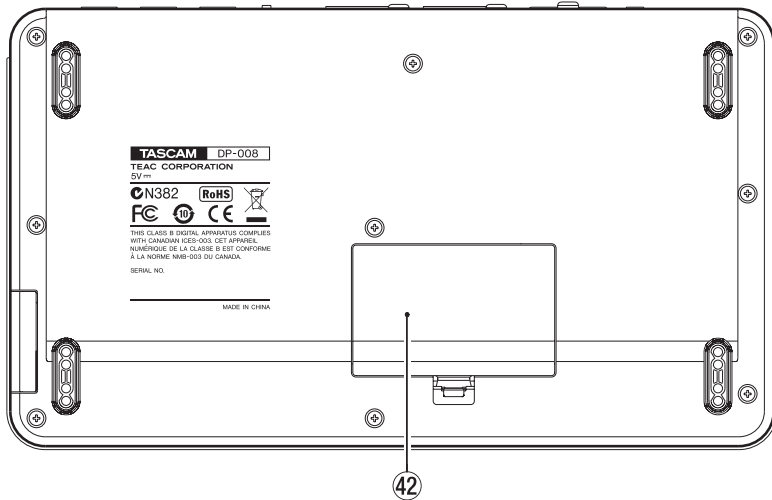

42 Battery compartment cover

43 Battery compartment  
The batteries (four AA) that power the unit are inserted here.

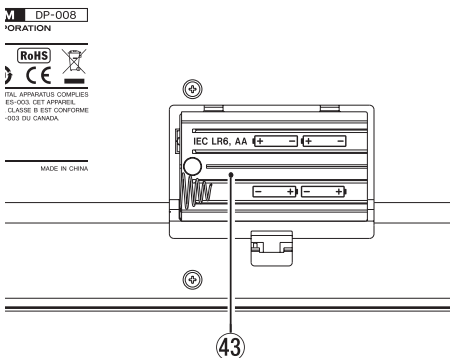

[Inside of the battery compartment]

# 3 – Names and Functions of Parts

## Home Screen

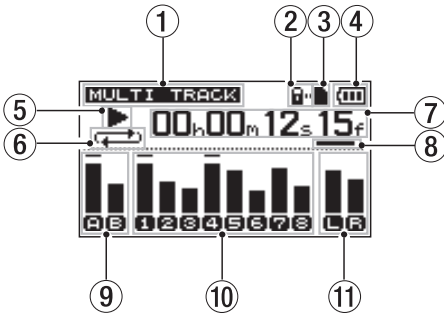

- ① **Recorder mode**  
Shows the current recorder mode.
- ② **SD card protected indication**  
This appears when the inserted SD card is protected.
- ③ **SD card insertion status**  
If an SD card is inserted appears. If not, appears.
- ④ **Battery status**  
When a battery is being used, a battery icon shows the amount of power remaining in bars (, , , ). The battery is almost dead and the power will soon turn off if the icon has no bars .  
When using the PS-P520 AC adaptor (sold separately) appears.
- ⑤ **Recorder transport state**  
When playing appears. When stopped appears. When recording appears.
- ⑥ **Repeat playback/auto punch mode indicator**  
When repeat playback is active appears.  
The icon appears when auto punch mode is active.
- ⑦ **Recorder time counter**  
Shows the elapsed time from the start of the song.
- ⑧ **Cursor key that shows the time increment being edited**  
Turning the DATA wheel changes the value of the selected time increment.
- ⑨ **Level meter and EQ status for INPUT A and B**  
Shows the signal level for input sources A and B.  
When INPUT EQ is ON, A and B are shown with frames (, ).
- ⑩ **Level meters for tracks 1–8 and mute/EQ status**  
Shows the input level when recording and the playback signal level when playing back.  
When mute is ON, the track number is shown in inverse (, , , ). When muting is OFF and the TRACK EQ is ON, the track number is shown with a frame (, , , ).
- ⑪ **Level meter for stereo outputs (L, R)**  
Shows the output signal level from the LINE OUT jacks.

# 4 – Preparations

## Preparing the power and SD card

### Installing an SD card

- 1 Make sure the unit power is OFF. Open the SD card slot on the right side of the unit.
- 2 Insert the SD Card into the slot as shown in the following illustration until it clicks into place.

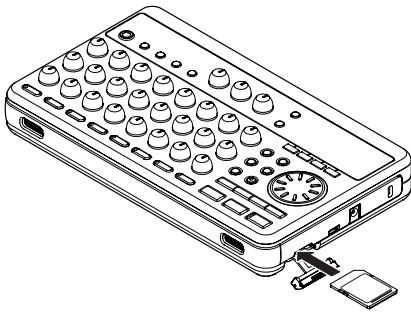

- 3 Close the cover.

### Ejecting the card

Push an inserted card in further to eject it.

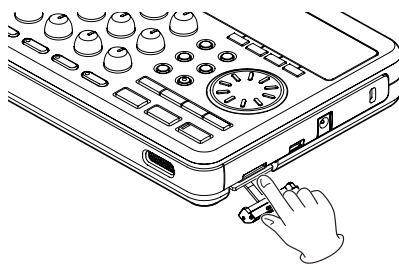

#### CAUTION

Always turn the power OFF before removing the batteries or the SD card. Removing either while the power is still ON will cause any recordings and settings made since the last time the power was turned OFF or the song was saved to be lost. These data and settings cannot be recovered.

### Write-protected cards

SD cards have write-protect (lock) switches.

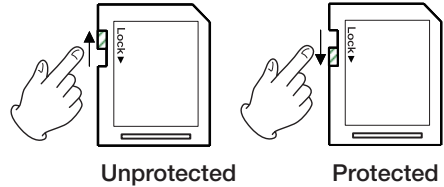

When the protect switch is in the LOCK position, files cannot be recorded or edited on the card. Slide the switch away from the LOCK position if you want to record, erase or otherwise changed files on a card.

### Preparing the power

This unit can be powered either by AA batteries or a PS-P520 AC adaptor (sold separately). Alkaline or NiMH batteries can be used with this unit.

### Installing batteries

Open the battery compartment on the bottom of the unit. Insert 4 AA batteries in the box according to the + and - indications.

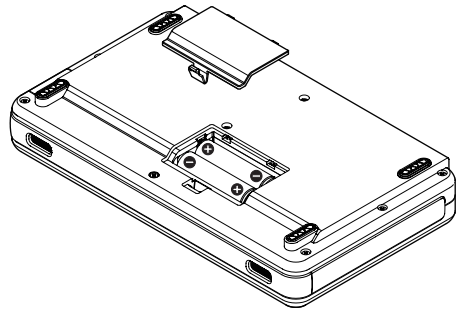

#### CAUTION

- The unit does not have charging ability. To use NiMH batteries, use an optional charger.
- The included alkaline batteries are for confirming the operation of the unit and might not last very long.

# 4 – Preparations

## Connecting an AC adaptor (sold separately)

To use the PS-P520 AC adaptor (sold separately), connect the adaptor to the unit and the adaptor to the power cord before plugging it into an outlet.

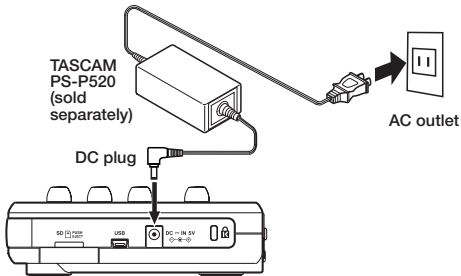

### CAUTION

Use only the PS-S520 AC adapter. Using an AC adapter other than the specified can cause a malfunction, fire, or electric shock.

### NOTE

- The adaptor powers the unit if the adaptor is connected even if batteries are installed.
- This unit can receive power from batteries or an AC adaptor. It cannot be powered by a USB connection.

## Start-up & shutdown

### Starting up the unit

Press and hold the **STANDBY/ON** key on the top panel until “TASCAM” appears. After the start-up screen, the Home Screen appears.



[Start-up Screen]



[Home Screen]

When the unit starts up it defaults to the **MULTI TRACK** recorder mode regardless of the mode used last before shutting down.

### CAUTION

When switching the unit on and off, we suggest that you turn down the volume of any speakers or amplifiers connected to the unit. Also, do not wear headphones connected to the unit when switching power on or off. This will avoid damage to speakers and possible harm to your hearing.

## Shutting down

Make the following preparations before shutting down the unit.

- Stop the recorder. (The unit cannot be shut down during recording, playback, fast forward, etc.)
- Return to the Home Screen.
- If the unit is connected to computer, disconnect the USB cable after conducting the necessary procedures on the computer to unmount the unit.

After making these preparations, press and hold the **STANDBY/ON** key until the following screen appears.



The power turns off after the unit completes its shutdown process, including saving various information from your session.

# 4 – Preparations

## CAUTION

- Do not remove the batteries or disconnect the power cable accidentally while the unit is operating. If you do so, the unit cannot shut down properly and all unsaved data will be lost. Lost data cannot be restored. We recommend that you also save the data manually often.
- When the power is turned off, the operation history of the currently loaded song will be erased (cleared). You will not be able to undo or redo operations on the song when you turn the power back on.

## Formatting SD cards

To use a new SD card with this unit, it is necessary to format it first. SD cards formatted by the unit are divided into MTR partitions and FAT partitions. SD cards with high capacities can be formatted with multiple partitions.

For more information about partitions see “10 – SD Card Management” on page 68.

## NOTE

The included SD card is already formatted so formatting is not necessary. If you format this card the demo song on it will be erased.

### 1 Set a new SD card.

The first time you put a new SD card in this unit, a screen prompting you to format it appears.



## NOTE

The screen prompting you to format it also appears if you put in an SD card that has been formatted by any device other than this unit.

## CAUTION

If you format it, all data saved by the other device will be erased and you will not be able to recover it.

### 2 Press the F3 (VE5) key to format the card including creating the standard number of partitions for the card capacity.

The Home Screen appears after the format completes correctly.

## NOTE

- To cancel formatting press the F4 (NO) key.
- Depending on the card capacity, the partition setting can be changed in some cases. To do so, set the partition size in the **FORMAT** item in the **CARD** menu before formatting (see “10 – SD Card Management” on page 68).

## Recorder modes

This unit has four recorder modes.

- **MULTI TRACK**  
This mode allows the unit to operate as a multitrack recorder.
- **BOUNCE**  
Use this mode to bounce tracks. (See “Bouncing tracks” on page 53.)
- **MASTER REC**  
Use this mode to mix down tracks and create a stereo master track. (See “Mastering” on page 48.)
- **MASTER PLAY**  
Use this to play a stereo master track that has been created.

When the power is turned ON, the unit always starts in **MULTI TRACK** mode.

When in modes other than **MULTI TRACK** mode, some screen operations do not function.

In this Owner’s Manual, unless otherwise noted, the recorder mode explained is assumed to be the **MULTI TRACK** mode.

# 4 – Preparations

## Connecting with other equipment

### Rear panel connections

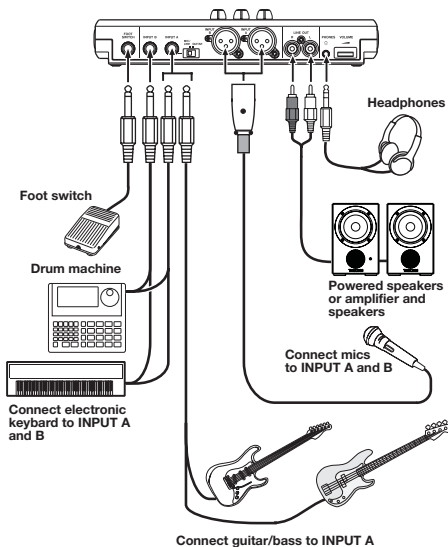

### Right side panel connections

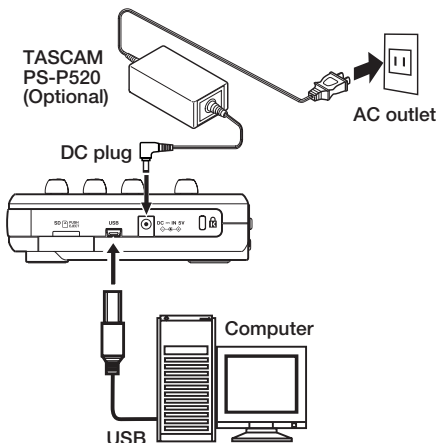

### NOTE

Recorder functions cannot be used when connected to a computer by USB.

## Adjusting the contrast

The LCD display contrast can be adjusted. Use the following procedures to adjust the contrast.

- 1 When the recorder is stopped, press the MENU key to open the MENU screen.
- 2 Turn the DATA wheel to select PREFERENCE and press the F4 (▶) key to open the PREFERENCE screen.
- 3 Use the F3 (▲) and F4 (▼) keys to select the Contrast value, and turn the DATA wheel to adjust the display contrast.



The selection range is from 1–10.

The default setting is 5.

Lower values make the display lighter while higher values make it darker. The display appears different depending on the angle from which you view it, so adjust it while the unit is in the actual position that you plan to use it in. Adjusting the contrast might make it easier to read.

- 4 After making the setting, press the HOME key to return to the Home Screen.

## Setting the backlight

To reduce power consumption when using batteries, you can change the length of time that the backlight stays lit.

- 1 When the recorder is stopped, press the MENU key.**
- 2 Use the DATA wheel to select the PREFERENCE menu, and press the F4 (▶) key to open the PREFERENCE screen.**
- 3 Use the F3 (▲) and F4 (▼) keys to select the setting value of the Back Light item, and use the DATA wheel to set the amount of time that the backlight stays lit.**

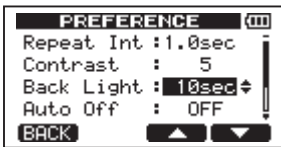

The setting options are OFF, 5sec, 10sec, 15sec and 30sec. When set to OFF the backlight always stays lit.

The default setting is OFF.

- 4 After making the setting, press the HOME key to return to the Home Screen.**

# 5 – Song Management

This unit manages data in song files. Ordinarily, every song is given its own file. The first step is to load the song that you want to manage (load an existing song or create a new song).

In a song, the audio data for the recorded multitrack (**TRACK 1–8**) and stereo master track that have been created are saved.

This chapter, starts with an explanation of SD card partitions, and then covers basic operations, including procedures for loading songs and creating new song, as well as various song management functions.

## Partitions and songs

This unit uses SD cards to record songs. SD cards formatted by the unit are divided into partitions. “MTR partitions” are for the recording of data and “FAT partitions” can be read by a personal computer. SD cards with high capacities are formatted with multiple MTR partitions.

When you want to record, playback or edit a song, select an MTR partition to make it the active partition and load a song on it or create a new song.

## Selecting the active partition

If you want to use a file that is on a partition other than the currently active partition in order to load an existing song or create a new song on it, you must change the partition. Follow these steps to select a partition on an SD card that has multiple MTR partitions.

- 1 When the recorder is stopped, press the MENU key to open the MENU screen.
- 2 Use the DATA wheel to select **CARD** and press the F4 (▶) key to open the **CARD** menu screen.

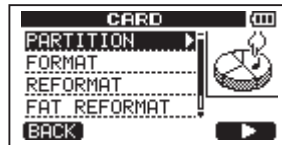

- 3 Use the DATA wheel to select **PARTITION** and press the F4 (▶) key to open the **PARTITION** screen. The display shows the MTR partition list.



[SD card with one partition]

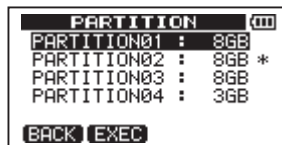

[SD card with multiple partitions]

An asterisk (\*) shows the active partition. The sizes of the partitions are shown (not available space).

- 4 Rotate the DATA wheel to select the partition and press F2 (EXEC). A confirmation message appears.



- 5 Press F3 (YES) to select. The unit saves the current song before changing partitions. It then loads the last used song on that partition.



# 5 – Song Management

## Editing names

You can edit names on the following screens.

- When creating, saving or editing the name of a track (SAVE, CREATE and NAME EDIT)
- When exporting a WAV file (EXPORT TRACK and EXPORT MASTER)
- When backing up a song (SONG BACKUP)



Use the following methods to edit names.

- Use the ◀◀/▶▶ keys to move the cursor (underline) position. The character at the cursor position is the one that is edited.
- Use the DATA wheel to change the characters at the cursor (underline) position. Ordinary symbols, numerals and English upper and lower case letters can be selected.
- To insert a blank at the cursor position when editing a song name, press the F3 (INS) key. Press it again to insert an “A” in the blank space.
- Press the F4 (DEL) key to delete the character at the cursor position.
- When finished inputting and editing, press the F2 (EXEC) key to save the edited name.

## Loading a saved song

Follow these procedures to load a song from the active partition.

- 1 When the recorder is stopped, press the MENU key to open the MENU screen.
- 2 Use the DATA wheel to select SONG and press F4 (▶) to open the SONG menu screen.
- 3 Use the DATA wheel to select LOAD and press F4 (▶) to open the SONG LOAD screen. A list of the songs on the active

partition appears with an asterisk (\*) next to the current song.

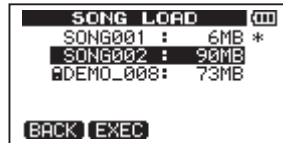
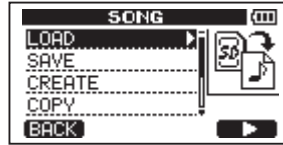

- 4 Use the DATA wheel keys to select the song to load and press F2 (EXEC). The current song is saved, and the selected song is loaded.
- 5 Press the HOME key to return to the Home Screen.

## Creating a new song

Follow these procedures to create a new song in the active partition

- 1 When the recorder is stopped, press the MENU key to open the MENU screen.
- 2 Use the DATA wheel to select SONG and press F4 (▶) to open the SONG menu screen.
- 3 Use the DATA wheel to select CREATE and press F4 (▶) to open the SONG CREATE screen.

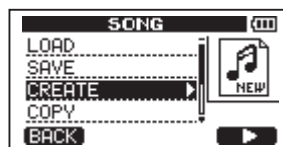

# 5 – Song Management

A default song name like SONG\*\*\* is given to the new song. The asterisks indicate a number. In the example above the name is SONG005.

- 4 Change the song name as necessary (see “Editing names” on page 37).

## TIP

You can rename a song later by selecting NAME EDIT from the SONG menu. You can also edit the song name when saving it.

- 5 Press F2 (EXEC) to save the currently loaded song and create the new song.
- 6 Press the HOME key to return to the Home Screen.

## Saving a song

This unit automatically saves the current song during shutdown and when loading another song, for example. You can also save a song at any time using the following procedures.

- 1 When the recorder is stopped, press the MENU key to open the MENU screen.
- 2 Turn the DATA wheel to select SONG, and press the F4 (▶) key to open the SONG menu screen.
- 3 Turn the DATA wheel to select SAVE, and press the F4 (▶) key.

The SONG SAVE screen appears.

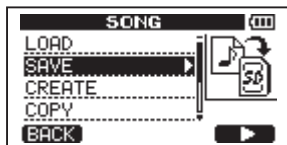

- 4 Change the song name if you want and then press the F2 (EXEC) key (see “Editing names” on page 37).
- 5 Press the HOME key to return to the Home Screen.

## Viewing song information

You can check the name, partition and remaining recording time of the currently loaded song.

1. Press the MENU key to open the MENU screen.
2. Turn the DATA wheel to select INFORMATION and press the F4 (▶) key.



This opens the SONG (1/3) page of the INFORMATION screen, which shows the name and remaining recording time of the current song.



## NOTE

The INFORMATION screen has three pages, including SONG (1/3), CARD (2/3) and FIW (3/3). Use the F1 (PREV) and F4 (NEXT) keys to change the page (see “Viewing information” on page 66).

## Copying songs

Songs in the currently active partition can be copied to the same and different MTR partitions. Multiple songs can also be copied at once.

# 5 – Song Management

- 1 When the recorder is stopped, press MENU to open the MENU screen.
- 2 Turn the DATA wheel to select SONG, and press the F4 (▶) key to open the SONG menu screen.
- 3 Turn the DATA wheel to select COPY, and press the F4 (▶) key.

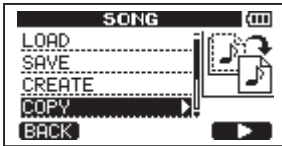

This opens the SONG COPY screen, which shows a list of songs in the active partition.

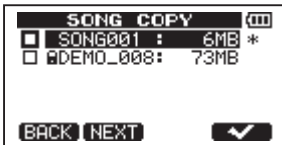

- 4 Turn the DATA wheel to select a song that you want to copy, and press the F4 (✓) key.

The song is selected as a copy source and a check appears in the checkbox.

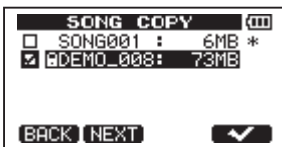

## NOTE

To remove the check from the checkbox (deselect the song), press the F4 (✓) key while the song is selected.

- 5 To copy multiple songs, repeat step 4.
- 6 After selecting all the songs that you want to copy, press the F2 (NEXT) key to open a screen where you can select the partition that you want to be the copy destination.



- 7 Turn the DATA wheel to select the copy destination partition and press the F4 (EXEC) key.

When copying completes, the SONG menu screen reopens.

- 8 Press the HOME key to return to the Home Screen.

- To cancel copying a song, press the F1 (BACK) key instead of the F4 (EXEC) key.

## Erasing songs

Songs can be erased. You can also erase multiple songs at once. You might want to erase unneeded songs if the SD card starts to run out of open space.

- 1 When the recorder is stopped, press MENU to open the MENU screen.
- 2 Turn the DATA wheel to select SONG, and press the F4 (▶) key to open the SONG menu screen.
- 3 Turn the DATA wheel to select ERASE and press the F4 (▶) key.

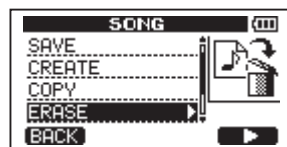

This opens the SONG ERASE screen, which shows a list of songs in the active partition.

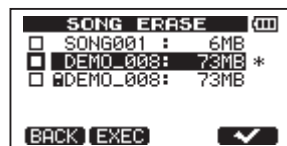

# 5 – Song Management

- Turn the DATA wheel to select a song that you want to erase and press the F4 (✓) key.

A check appears in the checkbox.

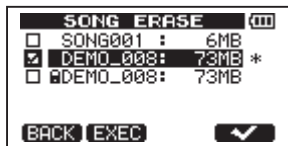

## NOTE

To remove the check from the checkbox (deselect the song), press the F4 (✓) key while the song is selected.

- To erase multiple songs, repeat step 4.
- After selecting all songs that you want to erase, press the F2 (EXEC) key.

A confirmation screen opens.

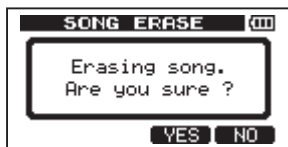

- Press the F3 (YES) key. After the songs are erased, the SONG menu screen reopens.

- Press the HOME key to return to the Home Screen.

- To cancel erasing a song, press the F4 (NO) key instead of the F3 (YES) key.
- Every MTR partition must always have at least one song, so if you erase all the songs on a partition, a new song is created automatically.

## Protecting songs

If you protect a song, editing, recording, and erasing of that song is prohibited.

- When the recorder is stopped, press the MENU key to open the MENU screen.
- Turn the DATA wheel to select SONG, and press the F4 (▶) key to open the SONG menu screen.
- Turn the DATA wheel to select PROTECT, and press the F4 (▶) key.



The SONG PROTECT screen that allows you to turn protection of a song ON and OFF appears.



- Turn the DATA wheel to turn PROTECT “ON,” and press the F2 (EXEC) key.

After protection is turned ON, the SONG menu screen reopens.

- Press the HOME key to return to the Home Screen.

- When the song list used to copy, erase and conduct other functions is open, a lock icon appears next to protected songs.
- If you try to execute a prohibited operation (edit, record, erase) on a protected song, “Song Protected” appears and the operation is prevented.
- To remove protection from a song, follow the above procedures but set PROTECT to “OFF” in step 4.

# 6 – Basic Recording

## Selecting the input source

This unit has two inputs (INPUT A and INPUT B) that can be selected separately as input sources.

The built-in mics (front panel MIC A and MIC B) or external input signals (inputs through the INPUT A and INPUT B jacks on the rear panel) can be selected as input sources. In addition to mic and line signals, the INPUT A 1/4" phone jack input can accept guitar input. Set the MIC/LINE-GUITAR switch on the rear panel according to the type of input.

- 1 Press the INPUT SETTING key to open the INPUT SETTING screen.

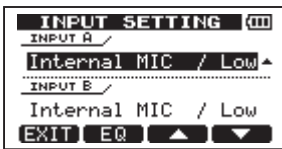

Use the INPUT A and INPUT B items to set the input sources for the INPUT A and INPUT B.

- 2 Use the F3 (▲) and F4 (▼) keys to select the INPUT A or INPUT B setting, and turn the DATA wheel to select the input source.

INPUT A/B selection choices

Choices	Description
Internal MIC / Low (default)	Built-in MIC A/B (low sensitivity)
Internal MIC / High	Built-in MIC A/B (high sensitivity)
Ext. Input, LINE / Low	External input A/B (low sensitivity)
Ext. Input / Mid	External input A/B (middle sensitivity)
Ext. Input / High	External input A/B (high sensitivity)

- 3 After changing the setting, press the HOME key to return to the Home Screen.
- 4 If a source that uses the INPUT A connector is selected as the INPUT A input source in step 2 above, set the MIC/

LINE-GUITAR switch on the rear side panel appropriately. Set it to GUITAR when connecting an electric guitar or electric bass directly. Set it to MIC/LINE when inputting a mic or line signal.

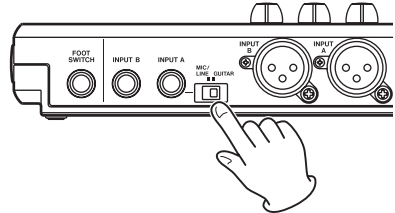

### TIP

When connecting an electric-acoustic guitar with a built-in preamp or an active electric guitar, as well as when connecting an electric guitar with effect boxes between it and this unit, set the MIC/LINE-GUITAR switch to MIC/LINE.

## Phantom power

When connecting a condenser microphone that requires phantom power, follow the procedures below to turn phantom power ON. When phantom power is ON, phantom power is provided to both INPUT A and INPUT B XLR jacks.

- 1 When the recorder is stopped, press the PHANTOM key to open the PHANTOM screen.

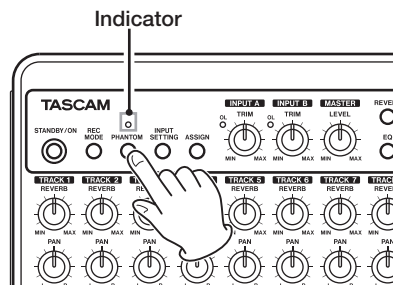

# 6 – Basic Recording

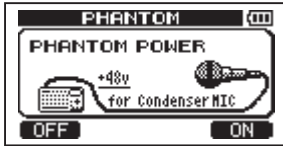

- 2 Press F4 (ON) to turn phantom power ON. The indicator above the PHANTOM key lights, and the Home Screen reopens.

To turn phantom power OFF, press the F1 (OFF) key in the previous step.

## CAUTION

- Turn the LEVEL knobs down before turning phantom power ON or OFF. Depending on the mic, a loud noise could occur, damaging equipment and harming people's hearing.
- Do not connect or disconnect a mic when phantom power is ON. This could cause a loud noise and damage equipment.
- Turn phantom power ON only when using a condenser microphone that requires phantom power.
- Do not supply phantom power to an unbalanced dynamic microphone. Doing so could break it.
- Supplying phantom power to some types of ribbon microphones could break them. Do not supply phantom power to a ribbon microphone if you are in doubt.
- Battery consumption is faster when phantom power is ON.

## Monitoring input signals

To monitor an input signal press the REC key for the TRACK set to record that signal. This will light/blink its REC indicator.

## NOTE

When the unit is playing back, both the playback signal and the input source signals are mixed and output through the PHONES and LINE OUT jacks and can be heard with connected headphones and monitoring systems.

## About the OL indicators and level meters

The audio levels of this unit can be checked using the INPUT A/B OL indicators and the level meters on the Home Screen.

The meters allow the signal levels to be checked, and they can also be used to confirm whether signals are being input into the unit. For example, if the input meters are moving a signal is being input into the unit even if you cannot hear anything when you are monitoring.

As shown below, if a “-” appears at the top of a meter, the level is too high (when a “-” appears, it will stay on screen for a while before automatically disappearing). If the level is too high and a “-” appears, the sound might be distorted, so lower the level until a “-” stops appearing.

If an OL indicator lights, the signal from the input source could be too loud or the TRIM knob too high.

If the OL indicator lights even though the TRIM knob is set to the minimum position, the input source signal is too strong. Change the INPUT SETTING or lower the volume on the input source.

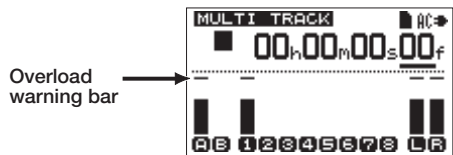

### Input level meters (A, B)

The two meters on the left side of this unit show the input levels of the INPUT A and INPUT B.

Use the INPUT A and INPUT B TRIM knobs, the INPUT SETTING and the output volume of the input source to adjust the level.

### Track level meters (1–8)

These meters show either the playback signal level or the input signal level for each track. The signal levels shown by the track meters

# 6 – Basic Recording

depend on the operating conditions as shown below.

- REC indicator not lit during playback: track playback signal
- REC indicator blinking (record standby) during playback: track playback signal
- REC indicator blinking (record standby) when the recorder is stopped: track input signal
- REC indicator lit (during recording): track input signal

## NOTE

When the playback signal is shown, the level of the recorded signal of the track is shown, so the level shown by the meters cannot be changed. When the input signal is being shown, the input levels, and thus the meters, can be changed using the TRIM knobs for INPUT A and INPUT B.

## Stereo level meters (L, R)

These show the stereo bus output level of this unit. Adjust the output level with the MASTER LEVEL knob.

## Assigning inputs

When using this unit, “assigning inputs” means setting the recording source for each track to either INPUT A or INPUT B.

This unit can simultaneously record a maximum of two tracks. You can also record one input to two tracks simultaneously (in this case, you cannot use the other input). You cannot assign two inputs to the same track.

- 1 When the recorder is stopped, press ASSIGN to open the INPUT ASSIGN screen.

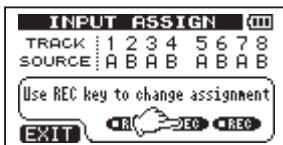

In the initial setting, A (INPUT A) is assigned as the recording source for tracks 1, 3, 5 and 7, and B (INPUT B) is assigned as

the recording source for tracks 2, 4, 6 and 8.

- 2 Use the REC keys to set the input source for each track to either A (INPUT A) or B (INPUT B).
- 3 When finished making settings, press the HOME key to return to the Home Screen.

## Using input EQ

INPUT A and INPUT B each have a two-band equalizer (EQ).

Use the INPUT SETTING screen to set input EQ.

- 1 Press the INPUT SETTING key to open the INPUT SETTING screen.

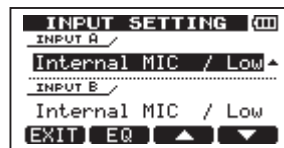

- 2 Press the F2 (EQ) key to open the equalizer setting screen.

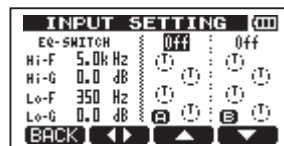

The input equalizer has the following parameters.

Parameter	Setting value
EQ-SWITCH (input EQ switch)	ON/OFF (Default: OFF)
Hi-F (high frequency range)	1.7 kHz – 18 kHz (Default: 5 kHz)
Hi-G (high range gain)	±12 dB (Default: 0.0 dB)
Lo-F (low frequency range)	32 Hz – 1.6 kHz (Default: 350 Hz)
Lo-G (low range gain)	±12 dB (Default: 0.0 dB)



# 6 – Basic Recording

Use the F2 (◀▶) key to switch between INPUT A and B.

Use the F3 (▲) and F4 (▼) keys to select parameters.

Use the DATA wheel to adjust the parameters.

Press the F1 (BACK) key to return to the previous INPUT SETTING screen.

- 3 After making the settings, press the HOME key to return to the Home Screen.

## NOTE

When input EQ is ON for an input, the input is shown on the Home Screen as in the illustration below.



Input EQ is ON

## Making the first recording

Before beginning the following recording procedures, prepare your monitors (headphones), connect a recording source to an input and assign that input as the recording source for a track.

- 1 Press the REC key of the track to record on. The REC indicator blinks red (that status is called “record standby”). A maximum of two tracks can be recorded simultaneously. If you press a different REC key when the REC indicators of two tracks are already blinking, the track that was put into record standby first will become inactive and the REC indicator will turn off.

For example, if you press the REC keys for TRACK 1, TRACK 2 and TRACK 3 in that order, TRACK 1, which was pressed first, will no longer be in record standby, but TRACK 2 and TRACK 3, which were

pressed afterwards, will be in record standby.

- 2 Set the recording level. Turn the (INPUT A or INPUT B) TRIM knob to adjust the input level of the input channel. Watch the display meters and the OL indicator above and to the left of the TRIM knob while setting the level suitably. At the same time, confirm that sound heard from the headphones or the monitor system is not distorted.

## NOTE

- The level meter of the track that has an input signal assigned to it shows the input level after the application of input EQ. Therefore, when using input EQ, you should also watch the level meter of the track that has the affected input signal assigned to it.
  - The OL indicator lights if the input is too loud.
  - If the OL indicator stays lit even when you lower the TRIM knob, lower the output level on the signal source connected to the input.
- 3 Press the playback (▶) key while pressing and holding the record (●) key. Recording starts and the record (●) key indicator lights red. The track REC indicator changes from blinking to lit.
  - 4 Press the stop (■) key to stop recording.
  - 5 To return to the starting point of the recording, press the ▶▶ key while pressing and holding the stop (■) key. (This is the Last Recording Point (LRP) function.)

To go to the beginning of the song (00:00:00:00), press the ◀◀ key while pressing and holding the stop (■) key. (This is the Return To Zero (RTZ) function)

- 6 Press the playback (▶) key to play the recorded track. Use the track LEVEL knob and the MASTER LEVEL knob to adjust the playback level. Use the VOLUME dial or the volume on your monitoring system to adjust the final



# 6 – Basic Recording

**monitoring volume.**

**Use the PAN knobs to set the stereo positions (between the left and right speakers) of each track signal.**

## NOTE

*The PAN and LEVEL knobs of each track control that track's playback output signal or monitored input signal. They do not control the signal being recorded to the track.*

- If you are not satisfied with the recorded sound, follow the procedures above again from the beginning.
- Press the ◀◀/▶▶ keys to rewind/fast forward (like a tape recorder). Press and hold these keys to increase the rewind/fast forward speed. Press the stop (■) key to stop.

## Multitrack recording

You can record new sounds to different tracks while playing back already recorded tracks.

### REC indicator settings

- Turn OFF the REC indicators of already recorded tracks.
- Press the REC key on the track that you want to overdub to put it into record standby (REC indicator blinking).

### Track pan and level settings

Use the LEVEL and PAN knobs of already recorded tracks to adjust their level and stereo positions for monitoring during overdubbing.

### Input selection and assignment

Use the procedures described earlier in this chapter to assign input sources to tracks for recording.

### Input level settings

When finished making settings, press the playback (▶) key to start playback.

Just as though you were recording, you can monitor the sound of already recorded tracks playing back and the input source on the track for recording, allowing you to check the monitor balance and volume.

## Making additional recordings

Press the playback (▶) key while pressing and holding the record (●) key.

This allows you to create a new recording on a different track while listening to the sound of tracks playing back.

## Mixdown

Adjusting the volumes and stereo positions of the recorded tracks to create a well-balance stereo mix is called mixdown.

## Level and balance

Use the TRACK 1–8 LEVEL knobs to adjust the relative balance between tracks. Use the MASTER LEVEL knob to adjust the overall level. Watching the L/R meters at the right of the display, adjust the level until it is suitable. If the volume is too loud, the sound will be distorted.

## NOTE

*The track meters on the Home Screen show the recorded signal levels on the tracks. Therefore, these meters do not change even when the LEVEL knobs are adjusted.*

## TIP

*You do not need to keep the entire song at the same volume. For example, you could gradually increase the volume during a guitar solo.*

## Stereo position (panning)

Using the PAN knob for a track, you can adjust the track signal's stereo position.

## Track EQ (equalizer)

Each track has a 2-band equalizer (EQ).

# 6 – Basic Recording

Set the track EQ using the EQ SETTING screen.

- 1 Press the EQ key to open the EQ SETTING screen.

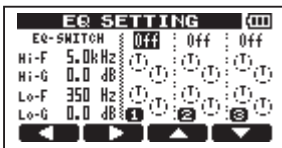
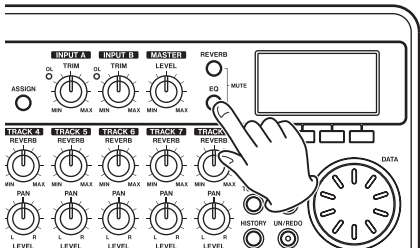

- 2 Set the track EQ (equalizer).

The track equalizer has the following parameters.

Parameter	Setting value
EQ-SWITCH (track EQ switch)	ON/OFF (Default: OFF)
Hi-F (high frequency range)	1.7 kHz – 18 kHz (Default: 5 kHz)
Hi-G (high range gain)	±12 dB (Default: 0.0 dB)
Lo-F (low frequency range)	32 Hz – 1.6 kHz (Default: 350 Hz)
Lo-G (low range gain)	±12 dB (Default: 0.0 dB)

Use the F1 (◀) and F2 (▶) keys to switch tracks.

Use the F3 (▲) and F4 (▼) keys to select parameters.

Use the DATA wheel to adjust the parameters.

- 3 After making the track EQ settings, press the HOME key to return to the Home Screen.

## NOTE

When track EQ is ON for a track, the track is shown on the Home Screen as in the illustration below.



Track EQ is ON

## Reverb

This unit has six types of reverb effects.

Adjust the level of the signal sent to the reverb effect from each track by using their REVERB knobs.

The signals are sent to the reverb effect after track EQ (equalizer) is applied.

- 1 Press the REVERB key to open the REVERB SETTING screen.

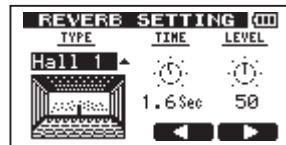
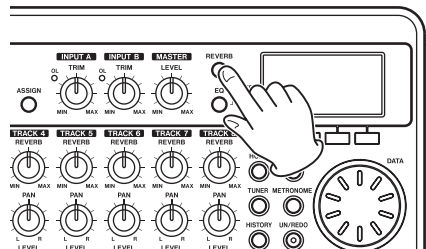

- 2 Adjust the reverb settings for the following parameters.

Parameter	Setting value
TYPE	Hall 1/Hall 2/Room/Studio/Plate 1/Plate 2 (Default: Hall 1)

# 6 – Basic Recording

TIME	0.2 (0.8 for plate type) – 3.2 seconds (Default: 1.8 sec)
LEVEL	0 – 100 (Default: 80)

Use **TYPE** to set the type of reverb.

Use **TIME** to adjust the reverb time (depth).

Use **LEVEL** to adjust the amount (volume) of the reverb.

The signal after the reverb effect is applied (return signal) is mixed into the stereo signal.

- After making the reverb settings, press the **HOME** key to return to the Home Screen.
- Use the track **REVERB** knobs to adjust the amount of signal sent to the reverb effect from each track.

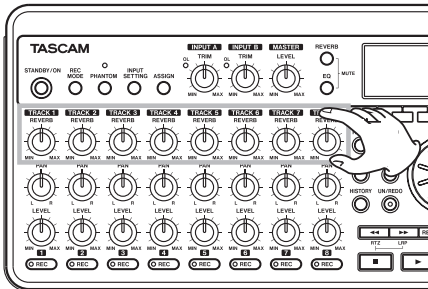

## NOTE

The reverb default values are as follows.

TYPE	Default values	
	TIME	LEVEL
Hall 1	1.8	80
Hall 2	2.2	80
Room	1.4	10
Studio	0.6	20
Plate 1	1.4	60
Plate 2	1.8	60

When the setting value is the same as the default value, **INI** appears below the setting value.

## Muting tracks

- Press the **EQ** key and **REVERB** key at the same time to open the **TRACK MUTE** screen.

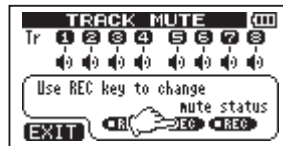
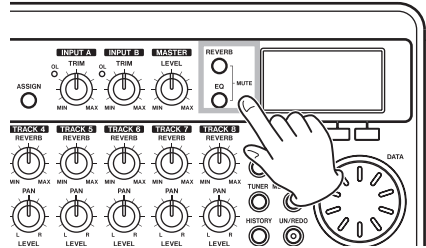

- Press the **REC** key of a track to turn mute **ON** or **OFF**. When mute is **ON**, the track number is shown in **inverse** (dark number on light background).



- After muting the tracks as desired, press the **HOME** key to return to the Home Screen.

## NOTE

When mute is **ON** for a track, the track number is shown on the Home Screen in **inverse** (dark number on light background).



Track mute ON indication

# 6 – Basic Recording

## Mastering

When you are satisfied with your mix, this unit can record and create a stereo master track internally. We call this process mastering. A stereo master track recorded by this unit is saved as part of the song, and can be recorded by an external stereo recorder. It can also be converted by the unit into a WAV file and exported to a computer (see “Exporting a stereo master track” on page 77).

### NOTE

Only one stereo master track can be made in a song at a time.

## Setting the end point

Before you start mastering, set the mastering end point. The time between the song’s zero point (00: 00: 00: 00) and the OUT point will be recorded as the stereo master track. Ordinarily, the end point of the song is set as the OUT point. In this case, the time at the OUT point is the length of the song. Use the following procedures to set the OUT (end) point.

- 1 Press the IN/OUT key to open the I/O SETTING screen.



- 2 Play the song back, and press the F4 (OUT) key at the position where you want the stereo master track end point. “SET OUT!” appears and this position is set as the OUT point.



### TIP

You can also set the OUT point when playback is stopped by pressing the F4 (OUT) key.

- 3 Press the HOME key to return to the Home Screen.

### NOTE

For how to adjust the OUT point and for other functions, see “Setting IN and OUT points” on page 55.

## Recording the master track

Set the OUT point before you start mastering.

- 1 Press the REC MODE key to open the RECORDER MODE screen.

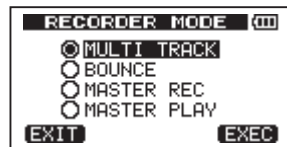

- 2 Turn the DATA wheel to select MASTER REC.

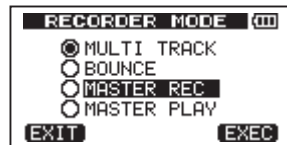

- 3 Press the F4 (EXEC) key to put the unit into master recording mode and return to the Home Screen. In this mode, the track mix signal (which will be recorded) is heard through headphones or a monitoring system during playback and recording.



# 6 – Basic Recording

## NOTE

- You cannot enter MASTER REC mode if you have not set an OUT point.
- If you try to enter MASTER REC mode when the length of the interval between IN and OUT points is too short, a “trk too short” pop-up message appears and you cannot enter MASTER REC mode.
- In MASTER REC mode, you cannot change the OUT point.
- Some playback functions and other functions do not work when the unit is in master recording mode. If you try to use one of these functions, an “In Master Mode” pop-up message appears.

- 4 Press the playback (▶) key while pressing and holding the record (●) key to start master recording.

The record (●) key indicator lights.

Regardless of the prior recorder position, recording starts from the 00:00:00:00 point (start of song).

Use the LEVEL and PAN knobs as necessary to control the mix. These adjustments do affect the recorded stereo master track.

Recording automatically ends when the recorder position reaches the OUT point.

After it ends, do the following to listen to the master track that you created.

- 5 Press the REC MODE key to open the RECORDER MODE screen.



- 6 Turn the DATA wheel to select MASTER PLAY.
- 7 Press the F4 (EXEC) key to put this unit into master playback mode and return to the Home Screen.
- 8 Press the playback (▶) key to play the stereo master track that you created.

The playback signal of the stereo master track is output through the PHONES or LINE OUT connector, so it can also be dubbed to an external stereo recorder.

- 9 If you are satisfied with this stereo master track, press the REC MODE key to open the RECORDER MODE screen. Turn the DATA wheel to select MULTI TRACK and press the F4 (EXEC) key to put the unit into multitrack mode (ordinary mode) again and return to the Home Screen.

If you do not like the stereo master track you made, follow the above procedures to make a master recording again. The new stereo master track replaces the previous stereo master track.

## NOTE

To listen to the recorded stereo master track in a saved song, load the song, set the recorder mode to MASTER PLAY and press the playback (▶) key to start playback.

## TIP

A stereo master track can be copied to any track pair among tracks 1–8 by creating a “clone” track (see “CLONE TRACK (track duplication)” on page 62).

## Undoing operations (undo)

This unit allows you to undo an operation or recording that did not work as planned or was otherwise unsatisfactory. Undo can be used on many ordinary operations, including editing and recording operations. This unit has two types of undo functions. Single undo can be used with a simple key press, while multi-undo allows you to return to and undo a specific past operation.

## NOTE

The UNIREDO indicator lights when single undo or multi-undo has been conducted and there are undone operations that can be redone.

# 6 – Basic Recording

## Undoing the last operation (single undo)

Press the UN/REDO key to return to the state before the last operation was conducted. After doing this, the UN/REDO indicator lights, showing that redo (see below) is possible.

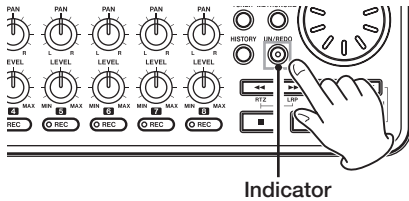

## Cancelling an undo operation (redo)

Press the UN/REDO key when it is lit to return to the state of the last operation. The UN/REDO indicator turns OFF.

### NOTE

If single undo is used when multi-undo (described below) has already been used to return the unit to a previous state, it will go one more step backward.

If you press the UN/REDO key again to redo, the single undo operation is cancelled, and the previous multi-undo state is restored. In this case, the operations undone by multi-undo are still retained in history, so the UN/REDO indicator stays lit.

## Undoing a previous operation (multi-undo)

- 1 Press the HISTORY key to open the HISTORY screen.

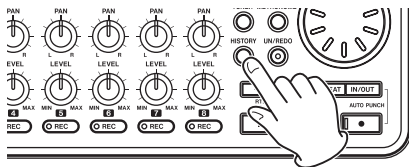

This screen shows the operation history as a list. Each operation in the list is called an “event.” The event list starts at the bottom with event number “0” (-START UP-). The top event is the most recent and has “\*” next to it.

All events that occurred after a selected event can be undone at once. This operation is called “multi-undo” because it allows you to undo multiple events and return to an earlier state.

- 2 Turn the DATA wheel to select the event that you want to return to (all events after the selected event will be undone).
- 3 Press the F2 (EXEC) key to execute the multi-undo and restore the song state to just after the selected event was conducted. In this state, the UN/REDO indicator lights.

The unit has been returned to a previous state, but the event information undone through the above operation is not erased. The unit has simply been returned to a previous state. On the HISTORY screen, a \* appears next to the most recent event after undoing.

### NOTE

When the HISTORY screen is open, the UN/REDO key does not function, so single undo and redo cannot be used.

### CAUTION

- When saving a song, a maximum of 500 items can be saved in the operation history as song data. If the operation history exceeds 500 items, the oldest events in the history are erased when the song is saved. Erased events cannot be restored.
- When the power is turned OFF the operation history is completely erased. The operation history is not restored when the power is turned ON again.

# 6 – Basic Recording

## Erasing the operation history

When the power is turned OFF, the operation history of the currently loaded song is erased (cleared). The operation history is not restored, so past operations cannot be undone or redone when the power is turned ON again.

### NOTE

The operation histories of songs that are not loaded are not erased when the power is turned OFF.

You can also erase (clear) the operation history of the currently loaded song without turning the power OFF.

- 1 Press the HISTORY key to open the HISTORY screen.



- 2 Press the F4 (CLEAR) key. A confirmation message appears.



- 3 Press the F3 (YES) key. A confirmation message appears again.



- 4 Press the F3 (YES) key to clear the operation history and erase unused data.

The Home Screen reopens when this operation completes.

- To cancel erasing the operation history, press the F4 (NO) key.

### TIP

- If you open the HISTORY screen immediately after erasing the operation history, the event (operation) that appears is "0" (START UP), showing that the operation history has been cleared.
- If you want to keep the operation history even when you power OFF, turn song protect ON before turning the power OFF (see "Protecting songs" on page 40).

### CAUTION

You cannot undo erasing the operation history! Only do it if you are certain about it.

# 7 – Recorder Functions

## Punching in and out

Punching in/out is a technique to replace a part of an already recorded track.

Start playback and when you reach the part that you want to replace, switch to record (punch in), then switch back to playback (or stop) when you finish the part that you want to replace (punch out).

- 1 **Decide what part of the track you plan to replace and choose a point to begin where the new recording can sit well with the existing recording.**
- 2 **Press the REC key of the track that you plan to replace part of to start record standby (REC indicator blinks).**
- 3 **Start playback before the part of the track that you want to replace.**
- 4 **Press the record (●) key to start recording (punch in) when you reach the part. Play or sing what you want to record.**
- 5 **Press the playback (▶) key to switch to playback (punch out) when you finish the replacement recording.**

### TIP

You can also press the stop (■) key to punch out at the end of the replacement recording.

## Using the foot switch to punch in/out

Using a foot switch connected to the FOOT SWITCH jack on the rear panel, you can punch in and out.

In step 4 above, step on the foot switch instead of pressing the record (●) key. In step 5, step on the foot switch again instead of pressing the playback (▶) key.

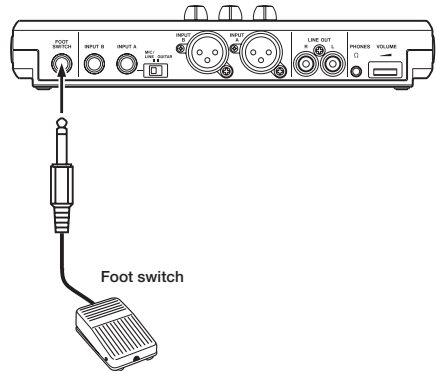

## Setting the foot switch polarity

Set the foot switch polarity on the PREFERENCE screen.

Connect the foot switch, and, without stepping on it, set FootSW Polarity to OFF. This will set the unit to operate properly for the polarity of the connected foot switch.

- 1 **Connect a foot switch to the FOOT SWITCH jack on the rear panel.**
- 2 **When the recorder is stopped and the Home Screen is open, press the MENU key.**
- 3 **Use the DATA wheel to select the PREFERENCE menu and press the F4 (▶) key to open the PREFERENCE screen.**
- 4 **Use the F3 (▲) and F4 (▼) keys to select FootSW Polarity.**
- 5 **Without stepping on the foot switch, use the DATA wheel to set the value to OFF.**

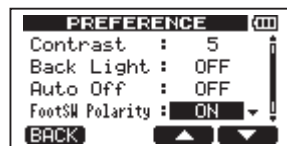

- 6 **After making the setting, press the HOME key to return to the Home Screen.**



# 7 – Recorder Functions

## Bouncing tracks

Use this unit's bounce function to mix already recorded tracks (1–8) down to one or two tracks.

Multitrack tape recorders can only bounce to an open track (in other words, they can not record to a track that is also a source of the mix). For example, tracks 1–7 could be bounced to track 8, but tracks 1–8 could not be bounced to track 1. This unit, however, does not have this limitation. You can bounce tracks 1–8 to mix down to tracks 1 and 2 (stereo bounce), or bounce tracks 1–8 as a mono mix to track 1 (mono bounce).

### NOTE

*Inside this unit, a mixdown is made to create a mix master that is recorded to the designated tracks.*

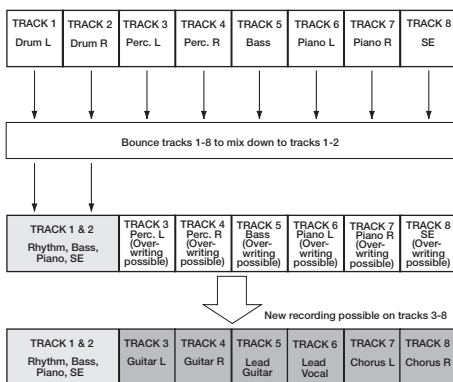

Source tracks are erased when they are bounce destinations. (In the illustration above the drum parts are overwritten by the stereo mix). However, you can use the unit's (undo) function to return to the previous state if you make a mistake (see "Undoing the last operation (single undo)" on page 50).

## Using the bounce function

- 1 Press REC MODE to open the RECORDER MODE screen.



- 2 Turn the DATA wheel to select BOUNCE.

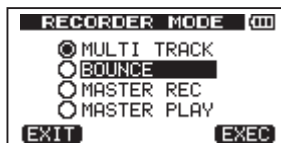

- 3 Press the F4 (EXEC) key to put the unit in bounce mode and return to the Home Screen.

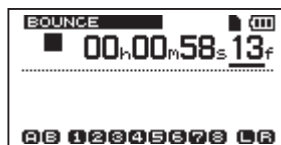

- 4 Press the REC keys for the bounce destination tracks (the indicators blink).

For a stereo bounce, press the REC keys for any two tracks. For a mono bounce (bouncing the mix to a single track) press the REC key for any one track.

- 5 Adjust the LEVEL and PAN knobs for the bounce source tracks.

When making a stereo bounce, the lower numbered track is the left (L) side.

For a mono bounce, turn the PAN knobs of the bounce source tracks all the way to L. Use the MASTER LEVEL knob to adjust the overall level.

- 6 After returning to the start of the song, press the playback (▶) key while pressing and holding the record (●) key to start the bounce.

## Confirming the result

Mute the bounce source tracks (see "Muting tracks" on page 47), and play

# 7 – Recorder Functions

the song from the beginning.

If you are not satisfied with the result because, for example, the balance between instruments is poor, or the pan settings are wrong, use the undo function (see “Undoing the last operation (single undo)” on page 50).

If you are satisfied with the result, press the REC MODE key to open the RECORDER MODE screen and select MULTI TRACK, then press the HOME key to return to the Home Screen.

After bouncing tracks, you can make new recordings over the other tracks.

## TIP

If it is possible that you might need the original tracks at some later time, back-up the track data to a computer or copy the song before bouncing (see “Backing-up songs” on page 73 and “Connecting with a computer” on page 71).

## Locate and search functions

### Direct locate function

The current recorder position is shown at the top of the display as “hours: minutes: seconds: frames” (there are 30 frames per second). You can move the current recorder position to a specific time by inputting it here.

- 1 On the Home Screen, use the HOME key to move the cursor (underline) between time divisions. You can edit the value at the cursor positions.

The seconds are selected in the following figure.



- 2 Turn the DATA wheel to change the value above the cursor. When adjusting, the

value will carry over automatically when it reaches the highest or lowest value in a field. For example, when turning the DATA wheel to increase the value in the seconds field, the number will change from 59 to 0 and the minutes value will increase by one. The time display blinks when using the DATA wheel. The blinking stops when the recorder moves to the displayed position.

- 3 Press the HOME key to move to a different time division and turn the DATA wheel to change the value.
- 4 After setting the desired time value, press the playback (▶) key to start playback from that position.

### Return To Zero (RTZ) and Last Recording Position (LRP)

Use simple key operations to return to the top of a song or to the position where recording last started.

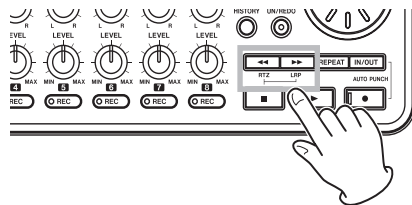

### Return To Zero (song beginning at 00:00:00:00)

Press the ◀◀ key while pressing and holding the stop (■) key.

### Last Recording Position (the position recording last started)

Press the ▶▶ key while pressing and holding the stop (■) key.

This function is useful when you want to record the same passage again.

# 7 – Recorder Functions

## TIP

RTZ and LRP below the ◀◀ and ▶▶ keys are abbreviations for Return To Zero and Last Recording Position, respectively.

## Fast forward/rewind search

Press the ◀◀ or ▶▶ key when stopped or during playback to rewind or fast forward, respectively.

Each time you press one of these keys, the speed increases from 10x to 50x, 100x and 1000x.

## Repeat playback

Use the repeat playback function to play the same part again and again.

The repeated passage is time between the IN and OUT points.

## Setting IN and OUT points

In addition to using them for setting the repeat playback passage, the IN and OUT points are also used for interval setting for track editing. Moreover, the OUT point is used as the end point of the master track when mastering.

## Capturing IN and OUT points

IN and OUT points can be captured when stopped, during playback or while recording.

- 1 Press the IN/OUT key to open the I/O SETTING screen.



- 2 Press the F3 (IN) key or F4 (OUT) key at desired position (regardless of whether the unit is stopped, playing or recording). “SET IN !” or “SET OUT !” and the captured time appear.

## TIP

You can also use the F3 and F4 keys to capture IN and OUT points when the Home Screen is open.



[SET IN]

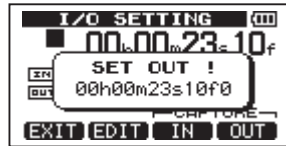

[SET OUT]

## Editing IN/OUT points

- 1 When the I/O SETTING screen is open (see the first screen figure in the previous section), press the F2 (EDIT) key to open the edit screen.



- 2 Edit the values of IN and OUT points using the following guidelines.
  - Use the F3 (▲) and F4 (▼) keys to move the cursor between the IN and OUT points.
  - Use the ◀◀/▶▶ keys to move the cursor between time fields.
  - Turn the DATA wheel to change the value at the cursor position.
- 3 When finished editing, press the HOME key to return to the Home Screen.

## NOTE

In the following cases, IN and OUT points cannot be captured or edited.

# 7 – Recorder Functions

- During repeat playback
- In auto punch in/out mode
- When the recorder mode is MASTER REC or MASTER PLAY

## Using repeat playback

- 1 Set the starting (IN) and ending (OUT) points for the time that you want to repeat, and then return to the Home Screen.
- 2 Press the REPEAT key to start repeat playback.

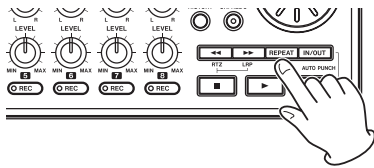

The repeat icon on the Home Screen appears.

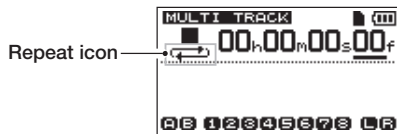

Playback starts from the IN point. When the OUT point is reached, after the repeat interval elapses, playback starts again from the IN point. Playback continues to repeat between the IN and OUT points.

- 3 Press the REPEAT key again to stop repeat playback.

The repeat icon on the Home Screen disappears.

The next section explains how to set the repeat interval that determines the amount of time until playback starts again after the OUT point is reached.

## Setting the interval between repetitions

The interval can be set from 1.0 to 9.9 seconds.

- 1 Press the MENU key to open the MENU screen.
- 2 Turn the DATA wheel to select PREFERENCE, and press the F4 (▶) key to open the PREFERENCE screen.

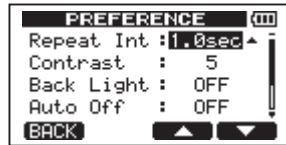

- 3 Use the F3 (▲) and F4 (▼) keys to select the setting value for the Repeat Int item. Turn the DATA wheel to set the value from 1.0 to 9.9 sec. in 0.1-sec. units. The default setting is 1.0sec.
- 4 When finished making settings, press the HOME key to return to the Home Screen.

## Locating to the IN or OUT point

When the Home Screen is open, press the F1 key while pressing and holding the STOP key to locate to the IN point.

Press the F2 key while pressing and holding the STOP key to locate to the OUT point

## Automatically punching in and out

When an IN point and an OUT point are set, press the record (●) key and the IN/OUT key at the same time to enter auto punch in/out mode.

Auto punch in/out mode includes a rehearsal function. When using this function, monitoring between the IN and OUT points in the same way as when recording is possible without actually recording.

## Rehearsal

- 1 Press the REC keys on tracks to use auto punch in/out with them.

# 7 – Recorder Functions

- 2 After setting the IN and OUT points, press the record (●) and IN/OUT keys at the same time to enter auto punch in/out mode.

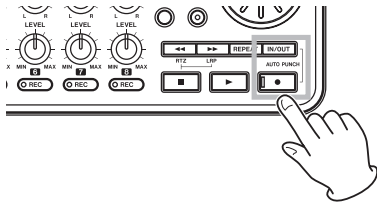

- 3 Press the playback (▶) key.

Playback begins from two seconds before the IN point, and the sound monitored switches at the IN point from the track playback sound and the input sound to just the input sound. The **REC** indicator blinks when between the IN and OUT points.

When playback reaches the OUT point, the track playback sound and the input sound becomes the monitored sound again, and the **REC** indicator stops blinking and turns off. Playback automatically stops one second after the OUT point.

You can repeat rehearsal until you are satisfied.

## Using auto punch in/out to record

When you are done rehearsing, you can use auto punch in/out for recording.

- 1 While in auto punch in/out mode, press and hold the record (●) key, and press the playback (▶) key.

In the same way as during rehearsal, playback begins from two seconds before the IN point. Recording occurs and the record indicator lights between the IN and

OUT points.

- 2 One second after reaching the OUT point, the recorder automatically stops, auto punch in/out mode is exited and the transport locates to two seconds before the IN point.

### NOTE

- Auto punch in/out mode cannot be entered during repeat mode or if no REC key has been pushed.
- Auto punch in/out can be undone.

# 8 – Editing Tracks

Editing on a conventional tape recorder in the past required advanced techniques, but with this unit editing tracks is easy and accurate. Moreover, with a tape recorder, an editing error could not be undone, but this unit uses nondestructive editing, allowing you to edit without altering the original data. This means that the undo function can be used to correct an edit easily (see “Undoing the last operation (single undo)” on page 50).

## Overview of track editing

This unit has the following track editing functions.

- COPY/PASTE (copy and paste)
- COPY/INSERT (copy and insert)
- MOVE/PASTE (move and paste)
- MOVE/INSERT (move and insert)
- OPEN (insert a silent section)
- CUT (remove part of a track)
- SILENCE (erase part of a track)
- CLONE TRACK (duplicate a track)
- CLEAN OUT (erase a track)

## Editing points

Among the track editing functions, COPY/PASTE, COPY/INSERT, MOVE/PASTE and MOVE/INSERT use the IN and OUT points as editing points. They also use the current position when the editing operation is begun as the TO point. SILENCE, CUT, and OPEN use the IN and OUT points. These IN and OUT points are the same IN and OUT points used during repeat playback. See “Setting IN and OUT points” (on page 55) for instructions about how to do this.

## IN point

The IN point is the starting point for the part of the track subject to track editing.

**Press the IN/OUT key to open the I/O SETTING screen.**

The IN point is saved as the time when the F3 (IN) key is pressed.

## OUT point

The OUT point is the ending point for the part of the track subject to track editing.

**Press the IN/OUT key to open the I/O SETTING screen.**

The OUT point is saved as the time when the F4 (OUT) key is pressed.

## TO point

The TO point is used as the PASTE destination point for COPY and MOVE operations.

The position where playback is currently stopped before opening the TRACK EDIT screen is set as the TO point.

The IN, OUT and TO points can also be changed on various editing screens.

## Basic editing procedures

- 1 **When the recorder is stopped and the Home Screen is open, press the MENU key to open the MENU screen.**
- 2 **Use the DATA wheel to select the TRACK EDIT menu, and press the F4 (▶) key to open it.**

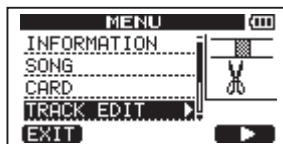

- 3 **Use the DATA wheel to select the desired track editing function, and press the F4 (▶) key to open that function's screen.**



# 8 – Editing Tracks

4 Select the setting item value. If there are multiple setting items, use the F3 (▲) and F4 (▼) keys to select one. Turn the DATA wheel to set an item's value.

5 Press the F2 (EXEC) key to execute the function.

Press the F1 (BACK) key to return to the TRACK EDIT menu screen without executing the function.

## Explanation of items

- SOURCE TRK
- OPEN TRK
- CUT TRK
- SILENCE TRK
- CLEAN OUT TRK

This is the track to be edited. The choices available depend on the editing function.

- 1 to 8: single tracks
- 1/2, 3/4, 5/6, 7/8: track pairs
- 1-8: all tracks
- MST: stereo master track
- ALL: all tracks or the stereo master track



[SOURCE TRK screen]

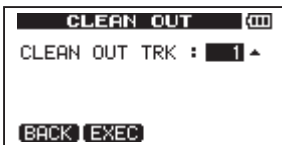

[CLEAN OUT TRK screen]

## IN/OUT/TO

These are the editing points. To change the IN, OUT or TO point, use the ◀/▶ keys to move the cursor and the DATA wheel to adjust the time.



[IN point editing screen]



[OUT point editing screen]



[TO point editing screen]

## DESTINATION TRK

Select the track that you want to be the destination for a COPY, INSERT or MOVE operation. The choices depend on what you have already chosen for the SOURCE TRK as the track to be edited.

When a single track has been set as the SOURCE TRK, the DESTINATION TRK choices are 1 to 8 (single tracks).

When a track pair (for example, 1/2) has been set as the SOURCE TRK, the DESTINATION TRK choices are 1/2, 3/4, 5/6 and 7/8 (track pairs).

When 1-8 (all tracks) has been set as the SOURCE TRK, the DESTINATION TRK choice is 1-8 (all tracks). In other words, this setting cannot be changed in this case.



# 8 – Editing Tracks

## COPY TIMES

Set the number of times that the copied section will be pasted. Set the number between 1 and 99.



## COPY/PASTE

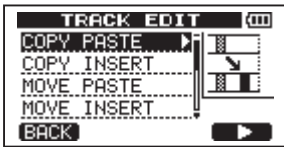
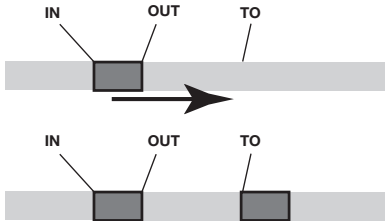

This function copies the audio data from between the IN and OUT points on the COPY source track, and pastes it on the COPY destination track starting from the TO point. This operation does not change the COPY source track.

This operation overwrites recorded data on the COPY destination track. Therefore, the length of the COPY destination track is not changed.

You can make multiple copies in a single operation. In other words, you can overwrite the COPY destination track from the TO point with a designated number of repetitions of the COPY data.

The following parameters are used in this operation.

- SOURCE TRK (1 to 8, 1/2, 3/4, 5/6, 7/8, 1-8)
- IN/OUT/TO

- DESTINATION TRK
- COPY TIMES

## COPY/INSERT

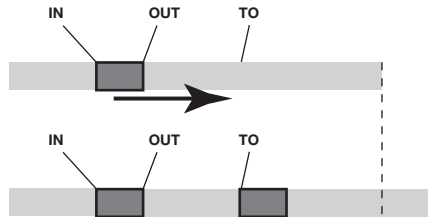

This function copies the audio data from between the IN and OUT points on the COPY source track, and inserts it on the COPY destination track starting from the TO point. This operation does not change the COPY source track.

This operation inserts recorded data into the COPY destination track. The recorded data on the COPY destination track after the TO point is offset by the amount of time used by the inserted audio data. Therefore, the COPY destination track becomes longer.

You can make multiple copies in a single operation. In other words, you can insert a designated number of repetitions of the COPY data into the COPY destination track from the TO point.

The following parameters are used in this operation.

- SOURCE TRK (1 to 8, 1/2, 3/4, 5/6, 7/8, 1-8)
- IN/OUT/TO
- DESTINATION TRK
- COPY TIMES



# 8 – Editing Tracks

## MOVE/PASTE

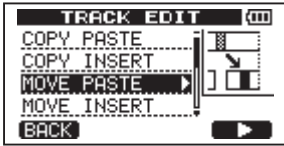
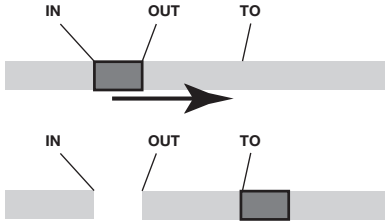

The audio data between the IN and OUT points on the MOVE source track is removed and pasted in the MOVE destination track starting from the TO point. This operation leaves a silence between the IN and OUT points on the MOVE source track.

This operation overwrites recorded data on the MOVE destination track. Therefore, the length of the MOVE destination track is not changed.

The following parameters are used in this operation.

- SOURCE TRK (1 to 8, 1/2, 3/4, 5/6, 7/8, 1-8)
- IN/OUT/TO
- DESTINATION TRK

## MOVE/INSERT

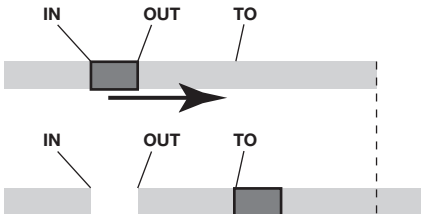

The audio data between the IN and OUT points on the MOVE source track is removed and inserted in the MOVE destination track from the TO point. This operation leaves a silence between the IN and OUT points on the MOVE source track.

This operation inserts recorded data into the MOVE destination track starting from the TO point. Therefore, the MOVE destination track becomes longer.

The following parameters are used in this operation.

- SOURCE TRK (1 to 8, 1/2, 3/4, 5/6, 7/8, 1-8)
- IN/OUT/TO
- DESTINATION TRK

## OPEN (insert silence)

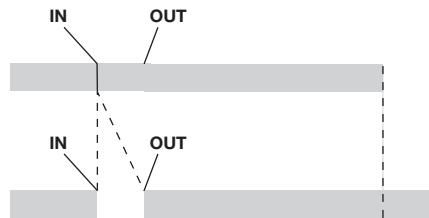

This function inserts silence between the IN and OUT points on the selected track.

This function splits the track at the IN point and shifts the recorded data after the IN point to after the OUT point. Therefore, the track becomes longer.

The following parameters are used in this operation.

# 8 – Editing Tracks

- OPEN TRK (1 to 8, 1/2, 3/4, 5/6, 7/8, 1-8, ALL)
- IN/OUT

## CUT (remove part)

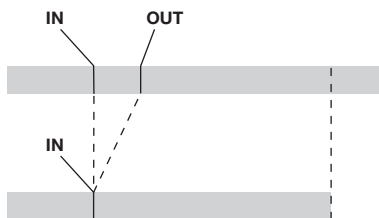

This function cuts (deletes) the audio data between the IN and OUT points on the selected track, and shifts the remaining recording after the OUT point forward to the IN point. Therefore, the track becomes shorter.

The following parameters are used in this operation.

- CUT TRK (1 to 8, 1/2, 3/4, 5/6, 7/8, 1-8, ALL)
- IN/OUT

## SILENCE (part erase)

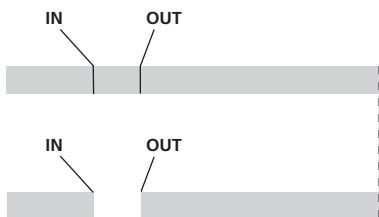

This function cuts (deletes) the audio data between the IN and OUT points on the selected track, leaving silence between the IN and OUT points, as though there had been no recording.

This operation does not change the length of the track.

The following parameters are used in this operation.

- SILENCE TRK (1 to 8, 1/2, 3/4, 5/6, 7/8, 1-8)
- IN/OUT

### TIP

Using this function, you can delete short noises, for example.

## CLONE track (track duplication)

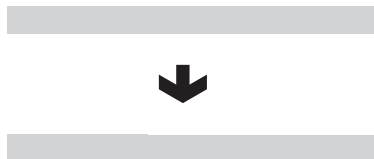

Use this function to duplicate a single track, a track pair or the master track on a different track or track pair. Each track is copied entirely, so the IN/OUT/TO points have no effect.

The following parameters are used in this operation.

- SOURCE TRK (1 to 8, 1/2, 3/4, 5/6, 7/8, MST)

- DESTINATION TRK

## NOTE

If you choose the same track for both the SOURCE TRK and the DESTINATION TRK and press the F2 (EXEC) key, the “Same Track” message appears and the operation is not executed.

---

## CLEAN out (track erase)

---



Use this function to completely erase the selected track. This erases the entire track, so the IN, OUT and TO points have no effect.

The following parameter is used in this operation.

- CLEAN OUT TRK (1 to 8, 1/2, 3/4, 5/6, 7/8, 1-8)

# 9 – Miscellaneous Functions

## Metronome

This unit has a built-in metronome function that can be used when the recorder is operating. You can set it to function during both playback and recording or only during recording.

- 1 Press the **METRONOME** key to open the **METRONOME** screen.

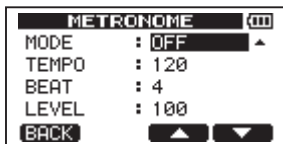
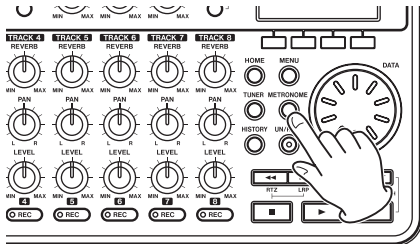

- 2 Set the following items. Use the **F3** (▲) and **F4** (▼) keys to select each item, and turn the **DATA** wheel to change the value.

### MODE

Select **OFF** (default, metronome OFF), **REC&PLAY** (functions both during recording and playback) or **REC ONLY** (functions only during recording).

### TEMPO

Set speed from 20 to 250 beats per minute (BPM).

The default setting is 120.

### BEAT

Set the frequency of the accent from 1 to 12 for different time signatures.

The default setting is 4.

### LEVEL

Set the metronome volume from 0 to 100.

The default setting is 100.

- 3 When finished making settings, press the **HOME** key to return to the Home Screen.

The metronome functions according to the **MODE** setting made in step 2 above.

The metronome signal is not recorded even if set to operate during recording.

### NOTE

- If you are using a mic to record and monitoring through speakers connected to this unit, the metronome sound might be recorded.
- When the metronome is operating, you can adjust the **LEVEL**, but other items on the **METRONOME** screen cannot be changed.

### TIP

- You can use the metronome like a click track to help keep time when recording the first tracks (rhythm guitar, bass, etc.) in a song.
- If you want to use the metronome when practicing, you can either turn each track's **LEVEL** knob all the way down during playback or play a song that does not have any recordings.

## Tuner

Use the built-in chromatic tuner to tune guitars and wind instruments.

In addition to the chromatic tuner mode, which allows you to tune an instrument while looking at the tuning meter, this unit's tuner also has an oscillator mode that outputs a standard pitch.

### Chromatic tuner mode

- 1 Connect a guitar or bass to **INPUT A**. **INPUT B** cannot be used for tuning.

Use built-in **MIC A** when tuning wind instruments, for example.

- 2 On the **INPUT SETTING** screen, set the **INPUT A** input source to **GUITAR/LINE** (see "Selecting the input source" on page 41).

# 9 – Miscellaneous Functions

To use the built-in mic, set the INPUT SETTING to Internal MIC.

- When the recorder is stopped, press TUNER to open the TUNER screen.

The value of the CALIB item (standard frequency) is selected.

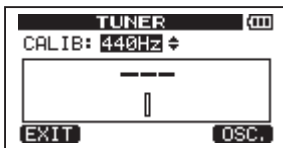
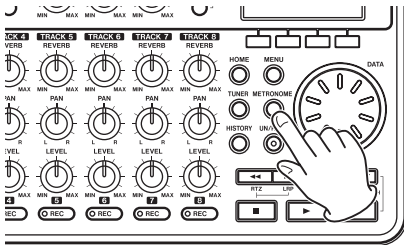

- Turn the DATA wheel to set the standard frequency of the A note between 435 and 445 Hz. The default setting is 440 Hz.
- Play the instrument and begin tuning. The pitch name closest to the string appears above the meters. Tune the string roughly until the sound name that you want appears. Then, fine tune the string until the rectangle at the middle of the meter darkens, showing that the string is in tune. If the pitch is too low, a bar extends to the left of the middle and if it is too high it extends to the right. The more out of tune, the longer the bar appears.

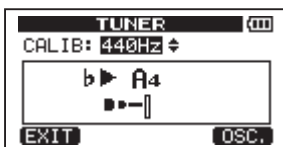

When the pitch played matches the note shown, the note name appears between the ►◀ icons.

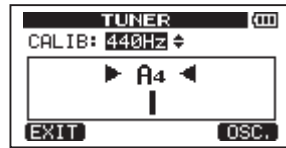

- When finished tuning, press the HOME key to return to the Home Screen.

## NOTE

If you want to monitor the input sound, press the REC key of a track that has INPUT A assigned to it.

## Oscillator mode

- When the recorder is stopped, press the TUNER key to open the TUNER screen.

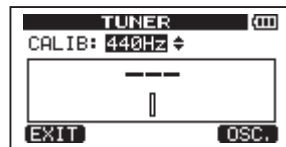

- Press the F4 (OSC.) key to display the oscillator screen.

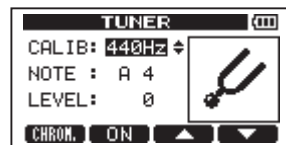

The following settings can be made on this screen.

### CALIB

Use this to adjust the standard frequency of A4. The setting range is 435Hz–445Hz. The default setting is 440Hz.

### NOTE

Use this to set the note output. The setting range is C3–B5. The default setting is A4.

### LEVEL

Use this to set the output level. The setting range is 10 (minimum) – 100 (maximum).

# 9 – Miscellaneous Functions

The default setting is 100.

Use the F3 (▲) and F4 (▼) keys to select parameters, and use the DATA wheel to set the parameter values.

Use the F2 (ON) key to turn the output ON and OFF.

Use the F1 (CHROM) key to change to chromatic tuner mode.

- 3 When you have finished tuning, press the HOME key to return to the Home Screen.

## Turning the power off automatically

You can set the time until the power automatically turns OFF after the last use when using the batteries.

- 1 When the recorder is stopped, press the MENU key to open the MENU screen.
- 2 Select PREFERENCE and press the F4 (▶) key to open the PREFERENCE screen.
- 3 Use the F3 (▲) and F4 (▼) keys to select the Auto Off setting value, and turn the DATA wheel to choose from these options: OFF (initial setting, Auto Off does not occur), 3min, 5min, 10min, 30min

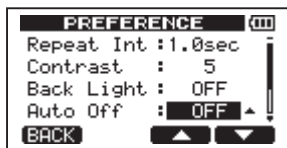

- 4 When finished making settings, press the HOME key to return to the Home Screen.

## Restoring the initial preference settings

You can restore the PREFERENCE screen settings to their initial values (the values that they had when the unit was shipped from the factory). This operation is called initialization.

- 1 When the recorder is stopped, press the

MENU key to open the MENU screen.

- 2 Turn the DATA wheel to select PREFERENCE, and press the F4 (▶) key to open the PREFERENCE screen.
- 3 Use the F3 (▲) and F4 (▼) keys to select Exec next to the Initialize item.  
Press F2 (EXEC) to open a confirmation screen.

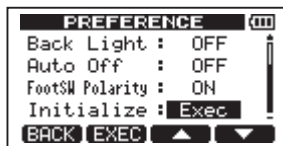

- 4 Press F3 (YES) to initialize the unit. The PREFERENCE screen reopens when the process finishes.



### NOTE

Press the F4 (NO) key to cancel initialization.

- 5 When finished, press the HOME key to return to the Home Screen.

## Viewing information

You can view information about the current song, the SD card and the firmware.

- 1 Press the MENU key to open the MENU screen.
- 2 Turn the DATA wheel to select INFORMATION and press the F4 (▶) key.



# 9 – Miscellaneous Functions

The INFORMATION screen SONG page appears.



The INFORMATION screen has three pages including this one.

### 3 Use the F3 (PREV) and F4 (NEXT) keys to change the page. The pages contain the following information.

SONG (1/3) page: name and partition of currently loaded song, remaining recording time on partition



CARD (2/3) page: MTR partitions and capacities, FAT partition capacity

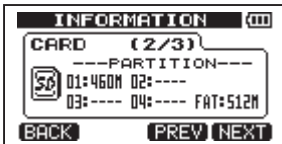

F/W (3/3) page: system firmware version

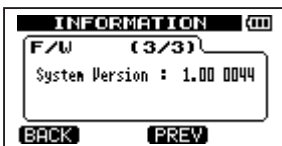

# 10 – SD Card Management

## Overview of partitions

As described in “Partitions and songs” (page 47), SD cards formatted by this unit are divided into partitions. MTR partitions are for recording data while the FAT partition can be accessed with a personal computer. High-capacity cards can have multiple MTR partitions. In this case, you can use the MTR partitions for different songs, for example, or copy songs to a different MTR partitions to save their information. The FAT partition is FAT32 format and can be accessed by a computer connected to this unit by USB. This FAT partition is used to save songs and export stereo master tracks to computers, as well as to allow this unit to import audio files into songs, for example. For this reason, two steps are necessary to copy from a MTR partition and a computer. You can also format an entire card or individual partition as well as change the divisions between partitions (repartition) as necessary.

### CAUTION

*Formatting and repartition operations cannot be undone!*

### NOTE

- The FAT (File Allocation Table) format is a disk format that can be read by a computer.
- SD and SDHC card that are at least 512MB in size can be used.

## Formatting cards and setting partition sizes

This operation formats the entire card and allows you set MTR partition sizes for high-capacity cards.

### CAUTION

*This operation erases all the data on the card and cannot be undone! Confirm that you will not lose important data before formatting a card.*

**1** When the recorder is stopped, press

MENU to open the MENU screen.

- 2 Turn the DATA wheel to select CARD, and press the F4 (▶) key to open the CARD menu screen.
- 3 Turn the DATA wheel to select FORMAT and press the F4 (▶) key.

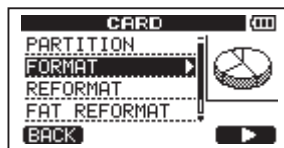

The FORMAT screen opens.

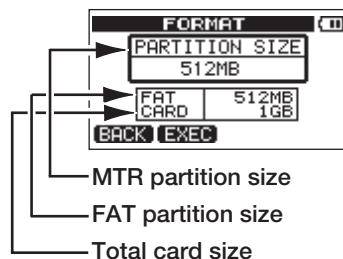

The following table shows the FAT and MTR partition sizes for different SD card capacities. The FAT partition size is set automatically according to card capacity. The size of the MTR partition on cards 4 GB or smaller is also fixed, but cards that are 8 GB or larger have multiple MTR partitions and their sizes can be chosen. However, the last MTR partition is set to fill the remaining space on the card automatically, so its size cannot be chosen.

### Card capacity and partition size

Card capacity	FAT partition size	MTR partition size
32 GB	4 GB	2 GB, 4 GB, 8 GB or 16 GB
16 GB	4 GB	2 GB, 4 GB or 8 GB
8 GB	2 GB	2 GB or 4 GB
4 GB	2 GB	2 GB fixed
2 GB	1 GB	1 GB fixed
1 GB	512 MB	512MB fixed



# 10 – SD Card Management

Card capacity	FAT partition size	MTR partition size
512 MB	256 MB	256MB fixed

- 4 If the card capacity is 8 GB or more, turn the DATA wheel to select the MTR partition size, and press the F2 (EXEC) key.

A message warning that all songs will be erased appears.



- 5 Press the F3 (YES) key to format the card.

For example, if you format a 16 GB card with 4GB MTR partitions, 12 GB are left for MTR partitions after 4 GB is used for the FAT partition. Three partitions are created. Two are 4 GB and the last one is 3 GB. (Since 1GB is actually 1024 MB, the total size of the partitions does not always match the card size.)

- When formatting finishes the CARD menu screen reopens.
- After formatting, one song is automatically created in each MTR partition.
- To cancel formatting, press the F4 (NO) key.

## Reformatting MTR partitions

You can reformat an MTR partition if you want. Use this function when you just want to format a specific partition without changing its size.

### CAUTION

*You cannot undo this operation! All the data on the selected partition will be erased, so be certain that you will not lose anything important when reformatting.*

- 1 When the recorder is stopped, press the MENU key to open the MENU screen.
- 2 Use the DATA wheel to select CARD, and press the F4 (▶) key to open the CARD menu screen.
- 3 Turn the DATA wheel to select REFORMAT.

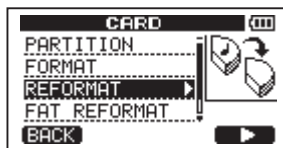

Press the F4 (▶) key to open the REFORMAT screen.



A list of the MTR partitions and their sizes (not open capacities) appear.

A \* marks the active partition.

- 4 Turn the DATA wheel to select the partition that you want to reformat and press the F2 (EXEC) key.

A pop-up message warning that all data on the partition will be erased appears.

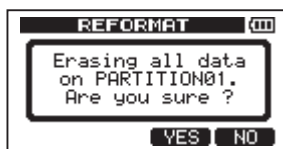

- 5 Press the F3 (YES) key to reformat the partition.
- When reformatting finishes the CARD menu reopens.
  - After reformatting, one song is automatically created in the MTR partition.
  - To cancel reformatting, press the F4 (NO) key.

# 10 – SD Card Management

## Reformatting the FAT partition

You can also reformat just the FAT partition. The size of the FAT partition cannot be changed.

### CAUTION

*You cannot undo this operation! All data on the FAT partition will be erased, so be certain that you will not lose anything important when reformatting.*

- 1 When the recorder is stopped, press the MENU key to open the MENU screen.
- 2 Turn the DATA wheel to select CARD, and press the F4 (▶) key to open the CARD menu screen.
- 3 Turn the DATA wheel to select FAT REFORMAT, and press the F4 (▶) key.

A pop-up message warning that all data on the FAT partition will be erased appears.

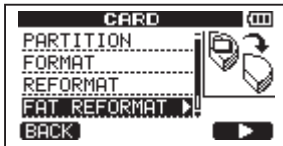

- 4 Press the F3 (YES) key to reformat the FAT partition.
- When reformatting finishes the CARD menu screen reopens.
  - To cancel reformatting, press the F4 (NO) key.

## Initializing SD cards

If you want to use an SD card that was used with this unit, we recommend that you initialize it.

When you initialize an SD card, the entire card is formatted as FAT32.

- 1 When the recorder is stopped, press the MENU key to open the MENU screen.
- 2 Turn the DATA wheel to select CARD, and press the F4 (▶) key to open the CARD menu screen.
- 3 Turn the DATA wheel to select the SD INITIALIZE item and press the F4 (▶) key.

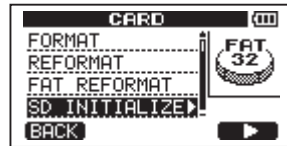

A pop-up message warning that all data on the card will be erased appears.



- 4 Press the F3 (YES) key to initialize the entire card and format it as FAT32.
- To cancel initialization, press the F4 (NO) key.

### NOTE

*After initializing an SD card, it is necessary to format it if you want to use it with the DP-008 again. (See "Formatting SD cards" on page 33).*

# 11 – Exchanging Data with a Computer

You can backup song data on this unit to a computer and restore backed-up song data later. Moreover, you can export track files and master files from a song to a computer and import audio files on the computer to the unit. Backed-up data can be restored to a different DP-008 unit than the one that created it. In other words, files can be freely exchanged between DP-008 units, making it easy to add additional recordings or mix existing recordings in a different location.

## NOTE

- *The MTR partitions where song files are stored cannot be directly accessed from a computer.*
- *In this chapter, “computer” refers to a Windows or Macintosh personal computer connected to this unit (see “Supported operating systems” below).*

## CAUTION

*If you want to remove an SD card from this unit and back-up its data on a computer using a card reader, always turn off the unit’s power before removing the card.*

The following types of data can be transferred from this unit to a computer.

## Entire songs

You can transfer the data for an entire song from the unit’s BACKUP directory on the FAT partition to a computer. This operation is called “backup.” In addition, data backed-up on a computer can be transferred to the BACKUP directory on the FAT partition, and then restored as song data. This operation is called “restore.”

## WAV format tracks

One or more tracks can be converted to WAV files and exported to a computer, and WAV files on a computer can be imported to this unit. These WAV files are stored on the WAVE directory of this unit’s FAT partition.

## Stereo master track

A stereo master track made on this unit can be transferred to a computer as a stereo WAV file from the WAVE directory on the FAT partition. Only export is possible.

## Supported operating systems

You can connect this unit to computers with the following operating systems.

### Windows

Windows XP, Windows Vista, Windows 7

### Mac OS X

Mac OS X 10.2 or later

When this unit is connected to a computer, the computer recognizes it as a removable disk. There is no need for a special driver.

## NOTE

*Data transfer between this unit and a computer occurs at USB 2.0 speed (maximum). Data can still be transferred if the computer connection is USB1.1, but it will be slower.*

*In addition, to assure USB 2.0 speed, use the included cable or a cable that meets USB 2.0 standards.*

## Connecting with a computer

To use the FAT partition of this unit, the unit must be connected to a computer by USB. When connected by USB, this unit’s record, playback and other recorder operations cannot be used.

To connect with a computer, connect the USB port on the right side panel of the unit with a USB port on the computer using the included USB cable. It does not matter whether you turn the unit’s power ON before or after the USB connection is made.

If the USB connection is made while the unit’s power is ON, the currently loaded song is saved before the USB connection becomes effective. When connected, the following screen appears on the display.

# 11 – Exchanging Data with a Computer

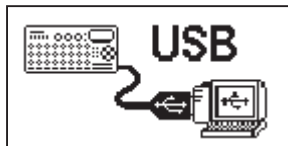

If you turn the unit's power ON after making the USB connection, the screen above appears right away.

The unit appears as an external drive named "DP-008" on the computer's display.

The FAT partition of the TASCAM DP-008 has three directories (folders): BACKUP, WAVE and UTILITY.

## CAUTION

- This unit can receive power from batteries or an AC adaptor. It cannot be powered by a USB connection.
- Do not change the names of three directories (folder) in "DP-008".
- The total number of files and folders that this unit can recognize on a FAT partition is 100. If the number exceeds 100, use a computer or other device to move them.
- Do not make a USB connection when the remaining battery level is low.
- If the power turns OFF during data transfer, all the data will be lost. This lost data cannot be restored.

## NOTE

- Confirm that you have copied all the files that you want to transfer to a computer to the FAT partition before connecting the unit and the computer by USB.
- The UTILITY directory is used to, for example, update the system software used by the unit. Please see the instructions included with the software update for how to update.

## Disconnecting

Use the following procedures to disconnect the USB connection correctly.

## NOTE

When disconnecting from a computer, the procedure on the computer might be called "eject" or "unmount."

## CAUTION

When transferring data, do not disconnect the unit or remove the USB cable. Doing so could cause data on the computer or this unit to be damaged.

## Disconnecting from Windows XP/Windows Vista/Windows 7

Follow the procedures below to disconnect computers that use Windows XP, Windows Vista, or Windows 7 operating systems.

A PC card icon and arrow appear in the taskbar (usually at the bottom right of the screen).



- 1 Left-click on this icon to open a pop-up bar. Click this pop-up bar to disconnect this unit from the computer.
- 2 After a message appears on the computer screen saying that this unit can be disconnected, remove the USB cable.  
This unit restarts and the Home Screen appears on the display.

- If a message appears on the computer screen saying that this unit cannot be disconnected safely, do not disconnect the USB cable. Close all the computer programs and windows that are accessing files on this unit, and then try the operation again.

## Disconnecting from Macintosh systems

- 1 Drag the "DP-008" icon that represents this unit to the Trash, or type Command-E to eject the DP-008.

## TIP

Depending on the OS version or OS settings you might also be able to eject the "DP-008" icon by clicking an eject button next to it in the Finder window or by using a control key.

# 11 – Exchanging Data with a Computer

- 2 After the icon disappears from the desktop, remove the USB cable.

This unit restarts and the Home Screen appears on the display.

## Song backup and restoration

Song backup saves not only audio tracks, but also backs up editing data and other song data. Song restoration is the reverse of this process. In short, song data is transferred from the computer to the FAT partition of the unit and then used to restore the song.

### Backing-up songs

Before starting a backup, check that the MTR partition that has the song that you want to backup is selected (see “Selecting the active partition” on page 36).

- 1 When the recorder is stopped, press the MENU key to open the MENU screen.
- 2 Turn the DATA wheel to select DATA BACKUP. Press the F4 (▶) key to open the DATA BACKUP menu.
- 3 Use the DATA wheel to select SONG BACKUP, and press the F4 (▶) key to open a song list.

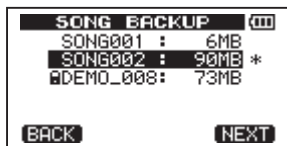

- 4 Turn the DATA wheel to select the song that you want to backup, and press the F4 (NEXT) key.

A screen appears that allows you to set the

file name for the song being backed up.



- 5 Use the ◀◀/▶▶ keys, the DATA wheel and the F3 (INS) and F4 (DEL) keys, to name the song (maximum of 8 characters) (see “Editing names” on page 37).
- 6 After setting the name, press the F2 (EXEC) key.

A backup copy of the song on the active partition is made on the FAT partition (“001” is added as an extension).

“Writing File” and an icon appear on the display.



When the backup is complete, the DATA BACKUP menu reopens.

### NOTE

If the open space necessary to back-up a songs is not available in the FAT partition, an error message appears. In this case, connect this unit and a computer, and erase unnecessary files on the partition using the computer to make enough open space.

- 7 Connect this unit to a computer using the USB cable (see “Connecting with a computer” on page 71).
- 8 Use the computer to copy backup files from the BACKUP directory on the FAT partition of the unit to the computer.
- 9 After copying finishes, disconnect the unit from the computer using the proper procedures and then remove the USB cable (see “Disconnecting” on page 72).

# 11 – Exchanging Data with a Computer

## CAUTION

- If you use a computer to change the name of a song file that has been backed up, use no more than eight ordinary single-byte English letters and numbers.
- Do not change the file extension.

## Restoring songs

Basically, restoring is the reverse of backing up. In short, transfer a backup file on a computer to this unit to restore a song.

- 1 Connect this unit to a computer using the USB cable (see “Connecting with a computer” on page 71).
- 2 Use the computer to copy backup files from the computer to the BACKUP directory on the FAT partition of the unit.
3. When copying finishes, disconnect the unit from the computer using the proper procedures and then remove the USB cable (see “Disconnecting” on page 72).
- 4 After this unit restarts automatically, press MENU to open the MENU screen.
- 5 Turn the DATA wheel to select DATA BACKUP and press the F4 (▶) key. DATA BACKUP screen appears.
- 6 Turn the DATA wheel to select SONG RESTORE, and press the F4 (▶) key.



The screen shows the backup files on the FAT partition.



## NOTE

An error message appears if there are no files on the FAT partition.

- 7 Turn the DATA wheel to select the file that you want to restore, and press the F2 (EXEC) key.

The actual song name and a confirmation message (“Are you sure?”) appear.

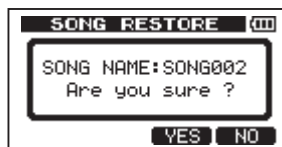

## NOTE

If the file name is short, spaces appear after the file name on the FAT partition, but those spaces are not included in the actual file name.

- 8 Press the F3 (YES) key.

After the currently loaded song is saved, the song selected in step 6 is restored and loaded.

## NOTE

If the open space on the card is insufficient, an error message appears.

- 9 Press the HOME key to return to the Home Screen.

## Track import and export

You can import and export individual tracks between a computer and this unit’s FAT partition. Files that can be imported/exported as tracks must be WAV files (with the “.WAV” extension). You can import both mono and stereo files and export mono files. If you want to import audio into this unit that is of a different format, you must convert it to a 16-bit, 44.1-kHz mono/stereo WAV file first.

# 11 – Exchanging Data with a Computer

## Importing tracks

Before importing a track, first select the partition with the song that you want to import it into as the active partition. Then, load the song that you want to import tracks into.

- 1 Connect this unit to a computer using the USB cable (see “Connecting with a computer” on page 71).
- 2 Use the computer to copy WAV files on its drive to the WAVE directory in this unit’s FAT partition.
- 3 Disconnect the unit from the computer using the proper procedures and then remove the USB cable (see “Disconnecting” on page 72).
- 4 After this unit restarts automatically, press the MENU key to open the MENU screen.
- 5 Turn the DATA wheel to select IMPORT/EXPORT, and press the F4 (▶) key to open the IMPORT/EXPORT menu.
- 6 Turn the DATA wheel to select IMPORT TRACK, and press the F4 (▶) key. WAV files on the FAT partition are shown.



### NOTE

- This unit cannot use WAV files that are a sampling frequency other than 44.1 kHz. Such files are not displayed even if they have been imported.  
If no files that can be imported are on the FAT partition, a pop-up saying “Import File Not Found” appears.

- If the file name is short, spaces appear after the file name on the FAT partition, but those spaces are not included in the actual file name.
- 7 Turn the DATA wheel to select the WAV file that you want to import, and press the F2 (NEXT) key.

The amount of open space on the currently active partition and the size of the selected WAV file appear on the display.



- 8 Turn the DATA wheel to select the track that you want to import the WAV file to, and press the F4 (EXEC) key. Importing begins.

### NOTE

- If there is not enough open space or the file format is wrong, an error message appears.
- The track that is the destination for the import must be empty.

This unit reads the file from the FAT partition, and imports it to the designated track. The beginning of the file is set at the start of the song (00:00:00:00).

In the same way as other recording tracks, you can edit the track that has received the imported file (see “8-Editing tracks” on page 58).

- To import a stereo WAV file, an empty track pair is necessary.
- 9 After importing completes, press HOME to return to the Home Screen.



# 11 – Exchanging Data with a Computer

## Exporting tracks

You can export tracks as 16-bit, 44.1-kHz mono WAV files.

- 1 When the recorder is stopped, press the MENU key to open the MENU screen.
- 2 Turn the DATA wheel to select IMPORT/EXPORT, and press the F4 (▶) key to open the IMPORT/EXPORT menu.
- 3 Turn the DATA wheel to select the EXPORT TRACK item, and press the F4 (▶) key.  
Song tracks that have audio recordings are displayed in a list. The file name makes the source track number clear.

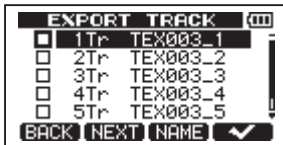

### TIP

Press F3 (NAME) to change the file name.



### NOTE

Song tracks that do have audio recordings are not displayed in the file list.

- 4 Turn the DATA wheel, to select a track for export, and press the F4 (✓) key to put a check in the checkbox.

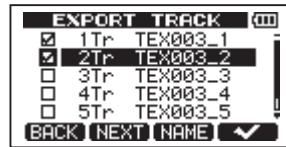

By checking multiple checkboxes, you can export more than one track at once. Select a track and press the F4 (✓) key again to remove the check from its checkbox.

- 5 When you finish putting checks next to the tracks that you want to export, press the F2 (NEXT) key.

The amount of open space on the FAT partition (which is the destination for the exported tracks) and the total number of tracks to be exported is shown.



- 6 Press the F4 (EXEC) key. The selected track is exported to the FAT partition with the edited file name with the ".WAV" extension added as the track file name. If you have previously exported a track file with the same name, a confirmation message ("Duplicate name - Are you sure?") appears. Press the F3 (YES) key to overwrite the older track.



- 7 Press the HOME key to return to the Home Screen.
- 8 Connect this unit to a computer (see "Connecting with a computer" on page 71).



# 11 – Exchanging Data with a Computer

9 Use the computer to copy track files from the WAVE directory on the FAT partition to the computer.

10 After exporting track files to the computer, disconnect the unit from the computer using the proper procedures and then remove the USB cable (see “Disconnecting” on page 72).

## Exporting a stereo master track

You can export a stereo master track that you have made on the unit (see “Mastering” on page 48) to a computer. When you create a new stereo master track for a song, the existing stereo master track is overwritten, so if you want to keep multiple different stereo master tracks, you might want to save them to a computer.

Before starting the following export procedures, make sure that the song that you want to export a stereo master track for is currently loaded and that you have already created a stereo master track for it.

- 1 When the recorder is stopped, press the MENU key to open the MENU screen.
- 2 Turn the DATA wheel to select IMPORT/EXPORT, and press the F4 (▶) key to open the IMPORT/EXPORT menu.
- 3 Turn the DATA wheel to select EXPORT MASTER, and press the F4 (▶) key.



The default file name is displayed and can be edited.



### NOTE

If there is no stereo master track, an error message appears.

- 4 Use the ◀▶ keys, the DATA wheel and the F3 and F4 keys to edit the name of the stereo master file being exported (See “Editing names” on page 37).
- 5 After setting the name, press the F2 (EXEC) key.

A stereo master track file is exported as a 16-bit, 44.1-kHz, stereo WAV file to the FAT partition. The file name of the exported file is the name set in step 3 above plus the “.WAV” extension.

If you have previously exported a stereo master track with the same name, a confirmation message (Duplicate name – Are you sure?) appears.

Press the F3 (YES) key to overwrite the older track.



### NOTE

To cancel exporting, press the F1 (BACK) key.

- 6 Press the HOME key to return to the Home Screen.
- 7 Connect this unit to a computer using the USB cable (see “Connecting with a computer” on page 71).
- 8 Use the computer to copy the stereo master file from the WAVE directory on the FAT partition of the unit to the computer.
- 9 After copying finishes, disconnect the unit from the computer using the proper procedures and then remove the USB cable (see “Disconnecting” on page 72).

# 12 – Troubleshooting

When working with any new piece of equipment like the unit, it's sometimes difficult to work out why something isn't happening the way you expect. The main thing is to take your time—after all, you're not paying hourly studio rates! Stop and think. Ask yourself questions, like the ones below, and you can usually find the answer.

Also, see the “Messages” section on page 79 for the meaning of messages that may pop up on the display. Consult this table when a message appears when an operation cannot be completed by the unit.

## Why can't I hear any sound when I play back?

- Are the **LEVEL** knobs of the tracks set to high enough?
- Is the **MASTER LEVEL** knob set to high enough?
- Have you connected the **PHONES** or **LINE OUT** jack to your monitoring system properly, and is your monitoring system set up correctly?
- Is the **VOLUME** control set to high enough?

## Why does the sound I'm recording sound distorted?

- Are the **TRIM** knobs of the **INPUT A** or **INPUT B** on the top panel of the unit set too high? Is the input source too loud?
- Isn't the monitor system distorted as the monitor level is too high?

## Why can't I record?

- You must have at least one track armed (**REC** indicator flashing) before you start recording by pressing the **PLAY** (▶) key while pressing the **RECORD** (●) key.
- Are input channels assigned to tracks (see “Assigning input” on page 43)?

## Why can't my computer “see” the unit files?

- Is the unit connected to the computer via the USB terminal (see “Connecting with a computer” on page 71)?
- Before making the USB connection, songs, tracks, or stereo master tracks are backed

up or exported to the FAT partition? (Files on the MTR partition cannot directly be read.)

## When using the AC adaptor, noise occurs if I connect a passive guitar or bass directly.

- Connecting another device to the unit's line output (**LINE OUT**) jacks might reduce the noise.
- This might be caused by interference noise from another device. If there is a power amplifier or other device that uses a large transformer, a fluorescent light or something similar nearby, you might be able to reduce the noise by changing the distance and orientation of this unit in relation to such equipment.

# 13 – Messages

The following popup messages alert you to conditions that may arise while you are using the unit. Consult this table if you see something you do not understand.

Messages	Meaning and remedy
Empty Export Track	You are trying to export a track ("Track import and export" on page 74) which does not have anything recorded on it. Pick another track to export.
File Not Found	You are trying to restore a song when there are no backed-up songs on the FAT partition ("Song backup and restoration" on page 73).
I/O Too Short	You are trying to enter repeat mode, but the time between the IN and OUT points is too short. Make the time longer.
Import File Not Found	You are trying to import a WAV file from the FAT partition when there are no WAV files there ("Importing tracks" on page 75). Connect the unit to a PC and transfer some files to the FAT partition for import.
Import File Too Large	You are trying to import a WAV file from the FAT partition that is too large for the remaining space on the partition. Free up some space on the (active) partition and try again.
In Bounce Mode	You tried to perform an action that cannot be done while in Bounce mode.
In Master Mode	You tried to perform an action that cannot be done while in Master mode.
In Repeat Mode	You tried to perform an action that cannot be done while in Repeat mode.
In Punch Mode	You tried to use a function that is prohibited during punch in/out mode.
Master Track Not Found	You have tried to export a stereo master track ("Exporting a stereo master track" on page 77) when the song does not have one. Master the song and then export the stereo master track.
Master Track Too Large	You tried to export a stereo master track which was too large for the remaining space on the FAT partition ("Exporting a stereo master track" on page 77). Connect the unit to a computer and free up some space on the FAT partition or reformat the FAT partition.
No Armed Track	You tried to enter auto punch in/out mode when no tracks were in record standby. (See "Automatically punching in and out" on page 56.) Put a track into recording standby before enabling auto punch in/out mode.
No Disk Space	You tried to create a song, but there is not enough space on the partition to create a song. Erase an unwanted song (see "Erasing songs" on page XX), format the card (see "Formatting cards and setting partition sizes" on page XX) or take other steps to make space available on a card.
No Master Trk	You have tried to use a non-existent master track as the source in a track cloning operation ("CLONE track (track duplication)" on page 62). Select another source or master the song and try again.
No Songs	You are trying to load a song from a partition that has no songs on it ("Loading a saved song" on page 37). Change partitions ("Selecting the active partition" on page 36).
No Undo History	There are no actions to be undone. See "Undoing operations" on page 49.
Not Stopped	The recorder is moving (not stopped, but playing back, recording, etc.) and you have pressed a key such as the <b>UN/REDO</b> key which cannot be used until you press <b>STOP</b> .
Now Recording	You are trying to perform an action which cannot be done while recording.

# 13 – Messages

Messages	Meaning and remedy
Same Track	You cannot clone a track to itself. ("CLONE track (track duplication)" on page 62.)
Song Protected	The song is protected ("Protecting songs" on page 40) and you are trying to change it (record or edit, etc.). Unprotect the song.
Too Many songs	You have 250 songs on one partition. You must delete some before you can create another song.
Track Full	This message appears if you try to import a file when all tracks already have recordings. (See "Importing tracks" on page 75.)
Trk Too Short	You are trying to master with the OUT point at the zero position ("Mixdown" on page 45 and "Mastering" on page 48). Set the OUT point ("Setting IN and OUT points" on page 55) and try again.
No SD Card	Insert an SD card after turning off the unit.
Invalid Card	Insert another SD card after turning off the unit, or format the card by <b>MENU → CARD → FORMAT</b> .
Protected Card	To record or edit, turn off the unit and un-protect the SD card.
Card Full	The SD card is full during recording.
Trk Edit Fail	Save the song and turn the unit off and then on, and perform track edit again.
Battery Empty	Replace the batteries with new ones or use a PS-P520 AC adaptor (sold separately).
Battery Low	Replace the batteries with new ones or use a PS-P520 AC adaptor (sold separately).
SD Size Error	Use an SD card larger than 512 MB.
Work Memory Full	Even if the card has enough remaining memory space, this error may occur when you record a long song or edit a lot. You may be able to continue the work if you clear the history ("Erasing the operation history" on page 51.) which may increase the open work memory. You may also be able to continue work by turning the unit off and then on again, which may increase the open work memory.
SD Not Found	If any of these errors occur, turn the the unit power OFF and restart it. If these error message continue to appear, please contact a TEAC Repair Center.
SD Read Busy	
SD Write Busy	
I/F Error	
FileErr	
Audio Rst Fail	
SaveParam Fail	
Mount Error	
SD-Card Error!	
FX Rx Failed	
FX Busy	

# 14 – Specifications and Block Diagram

---

## Audio input/output ratings

---

### INPUT A jack

- **XLR type (Balanced)**

Connector: XLR-3-31

(1: GND, 2: HOT, 3: COLD)

Input impedance: 2.4 k $\Omega$

Standard input level: -8 dBu

Maximum input level: +8 dBu

- **1/4" phone jack type (Unbalanced)**

Connector: 6.3 mm (1/4") phone jack

Input impedance:

- 10 k $\Omega$  (when **INPUT A** selector switch is set to **MIC/LINE**)

- 1 M $\Omega$  (when **INPUT A** selector switch is set to **GUITAR**)

Standard input level: -10 dBV

Maximum input level: +6 dBV

Headroom: 16 dB

### INPUT B jack

- **XLR type (Balanced)**

Connector: XLR-3-31

(1: GND, 2: HOT, 3: COLD)

Input impedance: 2.4 k $\Omega$

Standard input level: -8 dBu

Maximum input level: +8 dBu

- **1/4" phone jack type (Unbalanced)**

Connector: 6.3 mm (1/4") phone jack

Input impedance: 10 k $\Omega$  or more

Standard input level: -10 dBV

Maximum input level: +6 dBV

Headroom: 16 dB

### LINE OUT jack

Connector: RCA pin jack

Standard output level: -10 dBV

Maximum output level: +6 dBV

### PHONES jack

Connector: 3.5 mm stereo mini jack

Maximum output level: 20 mW + 20 mW or

more (THD + N 1 % or less, 32 $\Omega$  load)

---

## Audio performance

---

### Frequency response

INPUT (MIC/LINE) → LINE OUT: 20 Hz to 20 kHz

### Distortion

INPUT (MIC/LINE) → LINE OUT: 0.05% or less

### S/N ratio

INPUT (MIC/LINE) → LINE OUT: 81 dB or more

---

## General

---

### Recording media

SD card (512 MB - 2 GB) or SDHC card (4 GB - 32 GB)

### File system

MTR partition: TASCAM original

FAT partition: FAT32

### Built-in mic

Omni directional, Stereo

### Power supply

Four AA batteries or Optional AC adaptor (PS-P520)

### Battery life

About 5.5 hours (recording, phantom power off)

About 6 hours (playback)

(When measured with alkaline batteries.

Battery life may vary depending on the operating conditions)

### Operating temperature range

5 - 35°C/41 - 95°F

### Power consumption

2.4 W

# 14 – Specifications and Block Diagram

## Dimensions (WHD)

221 x 36 x 126.5 mm/

8.70 x 1.42 x 4.98 in

(w/o projections)

## Weight

610 g/19.69 oz (w/o batteries)

- Foot switch polarity

---

## Optional accessories

---

### AC adaptor

PS-P520

---

## Computer requirements

---

### Windows

Pentium 300 MHz or faster

128 MB or more memory

USB port (USB 2.0 recommended)

### Macintosh

Power PC, iMac, G3, G4 266 MHz or faster

64 MB or more memory

USB port (USB 2.0 recommended)

### Recommended USB host controller

Intel chipset

### Supported OS

Windows XP, Windows Vista and Windows 7

Macintosh Mac OS X 10.2 or later

---

## Backup memory

---

The following settings are backed up even when the unit power is turned off.

- INPUT SETTING item (except Input EQ)
- PREFERENCE item
  - Contrast
  - Backlight
  - Auto off

# 14 – Specifications and Block Diagram

## Dimensions

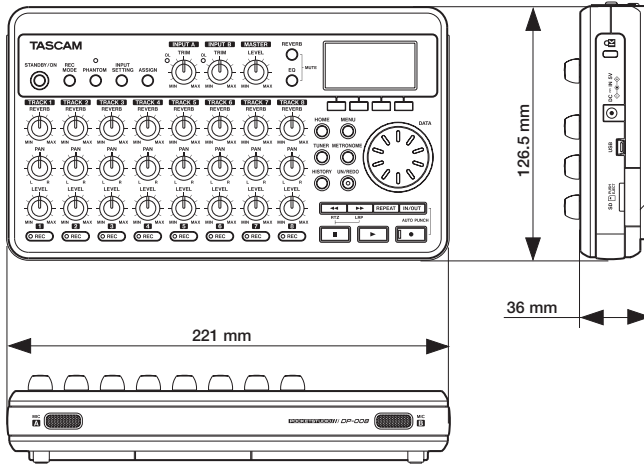

## Block diagram

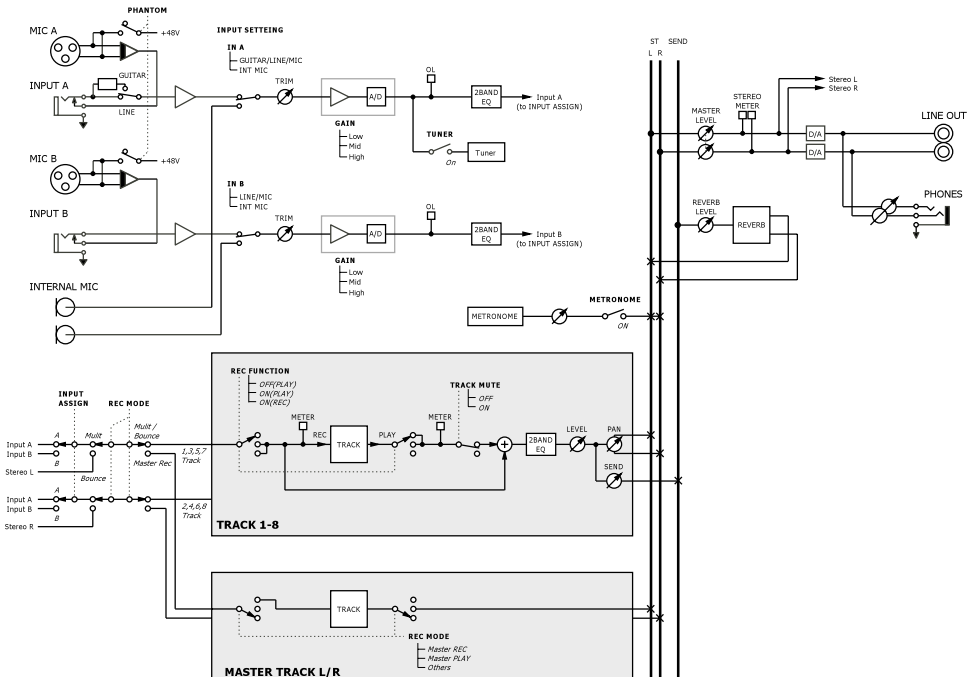

# 15 – Commonly-used Functions

This section is a brief guide to some operations on the DP-008 which may not be immediately obvious from looking at the panel controls.

- Key sequences are written like this: **STOP** + **◀◀** means “press and hold the **STOP** key and press **◀◀**.”
- Menu items are written like this: **MENU** → **CARD** → **FORMAT**, meaning “press the **MENU**

key, select the **CARD** menu, and then the **FORMAT** action.

- The list of popup messages and their meaning (“Messages” on page 79) may also be useful to you.

How to	Keys, etc. TO press	Description
Format the FAT partition	<b>MENU</b> → <b>CARD</b> → <b>FAT REFORMAT</b>	See "Reformatting the FAT partition" on page 70.
Set the IN and OUT points	"IN/OUT, <b>F3</b> , <b>F4</b> "	See "Setting IN and OUT points" on page 55.
Edit the IN and OUT points	"IN/OUT, <b>F2</b> "	See "Setting IN and OUT points" on page 55.
Use the USB connection	Connect the unit and a PC with the USB cable.	See "Connecting with a computer" on page 71.
Remove the USB connection	Disconnect the unit from a PC	See "Disconnecting" on page 72.
Import a WAV file to a track	<b>MENU</b> → <b>IMPORT/EXPORT</b> → <b>IMPORT TRACK</b>	See "Importing tracks" on page 75.
Choose another partition as the active partition	<b>MENU</b> → <b>CARD</b> → <b>PARTITION</b>	See "Selecting the active partition" on page 36.
Tune a guitar or wind instrument	<b>TUNER</b>	See "Tuner" on page 64.
Find out the current partition	<b>MENU</b> → <b>INFORMATION</b>	See "Viewing information" on page 66.
Make all of an SD card usable by a PC	<b>MENU</b> → <b>CARD</b> → <b>SD INITIALIZE</b>	See "Initializing SD cards" on page 70.
Format an SD card	<b>MENU</b> → <b>CARD</b> → <b>FORMAT</b>	See "Formatting cards and setting partition sizes" on page 68.
Create a new song	<b>MENU</b> → <b>SONG</b> → <b>CREATE</b>	See "Creating a new song" on page 13.
Create a stereo master track	<b>REC MODE</b> → <b>MASTER REC</b>	See "Mastering" on page 48.
Export a stereo master track to a PC	<b>MENU</b> → <b>IMPORT/EXPORT</b> → <b>EXPORT MASTER</b>	See "Exporting a stereo master track" on page 77.
Redo one operation	<b>UNDO/REDO</b>	See "Undoing operations" on page 49.
Undo one operation	<b>UNDO/REDO</b>	See "Undoing operations" on page 49.
Name a song	<b>MENU</b> → <b>SONG</b> → <b>NAME EDIT</b>	See "Editing names" on page 37.



# 15 – Commonly-used Functions

How to	Keys, etc. TO press	Description
Un-protect a song	<b>MENU</b> → <b>SONG</b> → <b>PROTECT</b>	See "Protecting songs" on page 40.
Display the song name	<b>MENU</b> → <b>INFORMATION</b>	See "Viewing information" on page 66.
Copy a song	<b>MENU</b> → <b>SONG</b> → <b>COPY</b>	See "Copying songs" on page 38.
Delete a song	<b>MENU</b> → <b>SONG</b> → <b>ERASE</b>	See "Erasing songs" on page 39.
Back up a song to a PC	<b>MENU</b> → <b>DATA BACKUP</b> → <b>SONG BACKUP</b>	See "Backing-up songs" on page 73.
Protect a song	<b>MENU</b> → <b>SONG</b> → <b>PROTECT</b>	See "Protecting songs" on page 40.
Save a song	<b>MENU</b> → <b>SONG</b> → <b>SAVE</b>	See "Saving a song" on page 38.
Load a song	<b>MENU</b> → <b>SONG</b> → <b>LOAD</b>	See "Loading a saved song" on page 37.
Delete the whole of a track	<b>MENU</b> → <b>TRACK EDIT</b> → <b>CLEAN OUT</b>	See "CLEAN OUT (track erase)" on page 63.
Insert silence at a point in a track	<b>MENU</b> → <b>TRACK EDIT</b> → <b>OPEN</b>	See "OPEN (insert silence)" on page 61.
Cut and close up part a track	<b>MENU</b> → <b>TRACK EDIT</b> → <b>CUT</b>	See "CUT (remove part)" on page 62.
Remove a section of a track and replace it with silence	<b>MENU</b> → <b>TRACK EDIT</b> → <b>SILENCE</b>	See "SILENCE (part erase)" on page 62.
Make an exact copy of (clone) a track	<b>MENU</b> → <b>TRACK EDIT</b> → <b>CLONE TRACK</b>	See "CLONE track (track duplicatin)" on page 62.
Export a track's contents to PC	<b>MENU</b> → <b>IMPORT/EXPORT</b> → <b>EXPORT TRACK</b>	See "Exporting tracks" on page 76.
Bounce tracks	<b>REC MODE</b> → <b>BOUNCE</b>	See "Bouncing tracks" on page 53.
Format one partition	<b>MENU</b> → <b>CARD</b> → <b>REFORMAT</b>	See "Reformatting MTR partitions" on page 69.
Restore a song from a PC	<b>MENU</b> → <b>DATA BACKUP</b> → <b>SONG RESTORE</b>	See "Restoring songs" on page 74.
Ping-pong (bounce) to ohter tracks	<b>REC MODE</b> → <b>BOUNCE</b>	See "Bouncing tracks" on page 53.
Metronome settings	<b>METRONOME</b>	See "Metronome" on page 64.
Use the metronome	<b>METRONOME</b>	See "Metronome" on page 64.
Find out how much time is left for recording	<b>MENU</b> → <b>INFORMATION</b>	See "Viewing song information" on page 38.
Playback a created stereo master track	<b>REC MODE</b> → <b>MASTER PLAY</b>	See "Mastering" on page 48.
Use the built-in mic	<b>INPUT SETTING</b>	See "Selecting the input source" on page 41.

# 15 – Commonly-used Functions

How to	Keys, etc. TO press	Description
Record a guitar	<b>INPUT SETTING</b>	See "Selecting the input source" on page 41.
Change the track to which INPUT A/B is assigned	<b>ASSIGN</b>	See "Assigning inputs" on page 43.
Change the interval time during repeat	<b>MENU → PREFERENCE</b>	See "Setting the interval between repetitions" on page 56.
Use the auto off function	<b>MENU → PREFERENCE</b>	See "Turning the power off automatically" on page 66.
Change the screen contrast	<b>MENU → PREFERENCE</b>	See "Adjusting the contrast" on page 34.
Add reverb	<b>REVERB</b>	See "Reverb" on page 46.
Use EQ on an input signal	<b>INPUT SETTING → F2</b>	See "Using input EQ" on page 43.
Use EQ on a track	<b>EQ</b>	See "Track EQ (equalizer)" on page 45.
Use phantom power	<b>PHANTOM</b>	See "Phantom power" on page 41.
Mute the playback sound of the track	<b>REVERB + EQ</b>	See "Muting tracks" on page 47.



**TASCAM**  
TEAC PROFESSIONAL

# DP-008

**TEAC CORPORATION**

Phone: +81-42-356-9143

[www.tascam.jp](http://www.tascam.jp)

1-47 Ochiai, Tama-shi, Tokyo 206-8530 Japan

---

**TEAC AMERICA, INC.**

Phone: +1-323-726-0303

[www.tascam.com](http://www.tascam.com)

7733 Telegraph Road, Montebello, California 90640, USA

---

**TEAC CANADA LTD.**

Phone: +1905-890-8008 Facsimile: +1905-890-9888

[www.tascam.com](http://www.tascam.com)

5939 Wallace Street, Mississauga, Ontario L4Z 1Z8, Canada

---

**TEAC MEXICO, S. A. de C.V.**

Phone: +52-55-5010-6000

[www.teacmexico.net](http://www.teacmexico.net)

Río Churubusco 364, Colonia Del Carmen, Delegación Coyoacán, CP 04100, México DF, México

---

**TEAC UK LIMITED**

Phone: +44-8451-302511

[www.tascam.co.uk](http://www.tascam.co.uk)

Suites 19 & 20, Building 6, Croxley Green Business Park, Hatters Lane, Watford, Hertfordshire. WD18 8TE, U.K.

---

**TEAC EUROPE GmbH**

Phone: +49-611-71580

[www.tascam.de](http://www.tascam.de)

Bahnstrasse 12, 65205 Wiesbaden-Erbenheim, Germany

---

Printed in China

## Free Manuals Download Website

<http://myh66.com>

<http://usermanuals.us>

<http://www.somanuals.com>

<http://www.4manuals.cc>

<http://www.manual-lib.com>

<http://www.404manual.com>

<http://www.luxmanual.com>

<http://aubethermostatmanual.com>

Golf course search by state

<http://golfingnear.com>

Email search by domain

<http://emailbydomain.com>

Auto manuals search

<http://auto.somanuals.com>

TV manuals search

<http://tv.somanuals.com>