

US-144MKII

USB 2.0 Audio/MIDI Interface

OWNER'S MANUAL

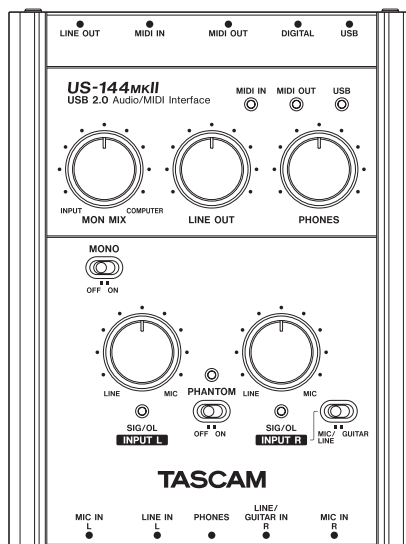

IMPORTANT SAFETY PRECAUTIONS

For U.S.A.

TO THE USER

This equipment has been tested and found to comply with the limits for a Class B digital device, pursuant to Part 15 of the FCC Rules. These limits are designed to provide reasonable protection against harmful interference in a residential installation. This equipment generates, uses, and can radiate radio frequency energy and, if not installed and used in accordance with the instruction manual, may cause harmful interference to radio communications.

However, there is no guarantee that interference will not occur in a particular installation. If this equipment does cause harmful interference to radio or television reception, which can be determined by turning the equipment off and on, the user is encouraged to try to correct the interference by one or more of the following measures.

- a) Reorient or relocate the receiving antenna.
- b) Increase the separation between the equipment and receiver.
- c) Connect the equipment into an outlet on a circuit different from that to which the receiver is connected.
- d) Consult the dealer or an experienced radio/TV technician for help.

CAUTION

Changes or modifications to this equipment not expressly approved by TEAC CORPORATION for compliance could void the user's authority to operate this equipment.

Declaration of Conformity

Model Number: US-144MKII
Trade Name: TASCAM
Responsible party: TEAC AMERICA, INC.
Montebello, California, U.S.A.
Telephone number: 1-323-726-0303

This device complies with Part 15 of the FCC Rules.

Operation is subject to the following two conditions:

- (1) This device may not cause harmful interference, and
- (2) This device must accept any interference received, including interference that cause undesired operation.

This appliance has a serial number located on the bottom panel. Please record the model number and serial number and retain them for your records.

Model number _____

Serial number _____

IMPORTANT SAFETY PRECAUTIONS

- 1 Read these instructions.
 - 2 Keep these instructions.
 - 3 Heed all warnings.
 - 4 Follow all instructions.
 - 5 Do not use this apparatus near water.
 - 6 Clean only with dry cloth.
 - 7 Do not block any ventilation openings. Install in accordance with the manufacturer's instructions.
 - 8 Do not install near any heat sources such as radiators, heat registers, stoves, or other apparatus (including amplifiers) that produce heat.
 - 9 Only use attachments/accessories specified by the manufacturer.
 - 10 Use only with the cart, stand, tripod, bracket, or table specified by the manufacturer, or sold with the apparatus. When a cart is used, use caution when moving the cart/apparatus combination to avoid injury from tip-over.
- Do not expose this apparatus to drips or splashes.
 - Do not place any objects filled with liquids, such as vases, on the apparatus.
 - Do not install this apparatus in a confined space such as a book case or similar unit.



产品有毒有害物质或元素的名称及含量

机种: US-144MKII		有毒有害物质或元素					
品名	铅 (Pb)	汞 (Hg)	镉 (Cd)	六价铬 (Cr(VI))	多溴联苯 (PBB)	多溴二苯醚 (PBDE)	
1 CHASSIS部份	○	○	○	○	○	○	
2 PCB Assy部份	×	○	○	○	○	○	
3 附属品部份	○	○	○	○	○	○	
4 SEAL部份	○	○	○	○	○	○	
5 包装部份	○	○	○	○	○	○	

○: 表示该有毒有害物质在该部件所有均质材料中的含量均在 SJ/T11363-2006 标准规定的限量要求以下。
 ×: 表示该有毒有害物质至少在该部件的某一均质材料中的含量超出 SJ/T11363-2006 标准规定的限量要求。
 (针对现在代替技术困难的电子部品及合金中的铅)

Contents

1 – Introduction	5	5 – Connections.....	19
Overview.....	5	USB connections	19
Features	5	Audio connections	19
What is in the package	5	Mic.....	19
Conventions used in this manual.....	6	Guitar	20
Trademarks	6	Sound module/MD/CD etc. (digital connection)	20
Precautions and notes for placement and use	6	Keyboard/drum machine/sound module/cassette deck/MD/CD etc. (analog connection)	21
Beware of condensation	7	Analog record player.....	21
Cleaning the unit	7	Monitor speakers	21
2 – Parts of the US-144MKII	8	Headphones	22
Top panel	8	MIDI connections.....	22
Front panel.....	10	6 – Application Guide	24
Rear panel.....	11	Windows XP and Windows Media Player.....	24
3 – Installation.....	12	Windows Vista and Windows Media Player	25
System requirements	12	Mac OS X and iTunes.....	26
Windows	12	Cubase LE4	26
Mac OS X	12	7 – MIDI Implementation Chart .	27
Installing the driver.....	12	8 – Troubleshooting.....	28
Installing the driver for Windows ...	13	9 – Specifications	31
Installing the driver for Mac OS X ..	15	Input/output ratings	31
Uninstalling the driver.....	15	Analog audio input/output	31
Frequently asked installation questions and answers (FAQ)	15	Digital audio input/output.....	31
Settings on your computer	16	Control input/output	32
Installing Cubase LE4.....	16	Audio performance.....	32
4 – US-144 MKII Control panel settings.....	17	Computer requirements.....	32
Overview.....	17	Windows	32
Control panel settings	17	Macintosh	33
Audio Performance.....	17	General	33
Sample Clock Source	18	Dimensions	34
Digital Output Format	18		
"ch1 and ch2" and "ch3 and ch4" .	18		
LINE OUTPUTS and DIGITAL OUTPUT.....	18		
USB 1.1 Mode Input Selection.....	18		

1 – Introduction

Thank you for your purchase of the TASCAM US-144MKII USB 2.0 Audio/MIDI Interface.

Please read this owner's manual carefully before you begin using the US-144MKII, and use the product correctly as directed in order to ensure long and trouble-free enjoyment of all its functionality.

After you have read this manual, keep it nearby for reference when required.

You can also download the Owner's Manual from the supplied CD-ROM or the TASCAM web site (<http://www.tascam.com>).

We can accept no responsibility for any loss of the data you record using this product onto other MIDI equipment in your system or onto storage devices such as hard disk.

Overview

The US-144MKII is a USB-based audio/MIDI interface designed for use with Digital Audio Workstation (DAW) software. It provides a four-input, four-output 24-bit 96 kHz audio interface and a 16-channel MIDI interface.

Because the US-144MKII is USB-based, it is the ideal companion to any desktop or laptop-based digital recording setup. And since the US-144MKII operates using only USB power, you can use it with a laptop computer to create a very compact and portable digital audio workstation system.

The US-144MKII is also an ideal way to capture analog sources such as records or cassette tapes into your computer and preserve them as audio CDs.

Features

- 24-bit/96 kHz audio interface.
- 4-channel (two analog and two digital) signals can be input at the same time and recorded simultaneously into your computer via USB.
- Two XLR mic inputs (balanced) and two 1/4" phone mic inputs (balanced/unbalanced) are provided. One of the 1/4" phone inputs can be switched to allow direct input of an electric guitar or electric bass (R channel only).
- Unbalanced stereo line output (RCA connector) and headphone output.
- S/PDIF digital input and output
- MIDI IN/OUT.
- Direct Monitor function allows zero-latency monitoring of the input.
- Power is supplied by the USB connector.

A note about computer operation

If you are unsure about how to perform basic computer operations appearing in this manual, please refer to the owner's manual that came with your computer.

What is in the package

The US-144MKII package contains the following items.

Take care when opening the package not to damage the items. Keep the package materials for transportation in the future.

Please contact the store where you purchased this unit if any of these items are missing or have been damaged during transportation.

1 – Introduction

- US-144MKII main unit
- USB cable
- CD-ROM (containing driver and manuals)
- DVD-ROM (Cubase LE4)
- Cubase LE4 Quick Start Guide
- Warranty card
- Owner's manual (this document)

Conventions used in this manual

The following conventions are used in this manual:

- Front panel keys, knobs, and indicators, and rear panel connectors are designated in all-capital letters.

Example: **LINE IN** jacks

- This typeface is used to designate messages displayed by the software.

Example: Control Surface Protocol

- *This typeface* is used to designate software menu functions and on-screen controllers.

Example: *ASIO Device*

- Additional information is introduced in the styles below when needed:

TIP

Useful hints when using the unit.

NOTE

Explanation of actions in special situation and supplement.

CAUTION

Instructions that should be followed to avoid injury, damage to the unit or other equipment, and loss of data.

Trademarks

- TASCAM is a registered trademark of TEAC Corporation.
- Microsoft, Windows, Windows XP, and Windows Vista are either registered trademarks or trademarks of Microsoft Corporation in the United States and/or other countries.
- Apple, Macintosh, Mac OS and Mac OS X are trademarks of Apple Inc., registered in the U.S. and other countries.
- Pentium and Intel are trademarks of Intel Corporation in the U.S. and other countries.
- AMD Athlon is a trademark of Advanced Micro Devices, Inc.
- Cubase is a registered trademark of Steinberg Media Technologies GmbH. ASIO is a trademark of Steinberg Media Technologies GmbH.
- Other company names, product names and logos in this document are the trademarks or registered trademarks of their respective owners.

Precautions and notes for placement and use

- Do not place any object on the unit for heat dissipation.
- Avoid installing this unit on top of any heat-generating electrical device such as a power amplifier.

1 – Introduction

Beware of condensation

If the unit is moved from a cold to a warm place, or used after a sudden temperature change, there is a danger of condensation; vapor in the air could condense on the internal mechanism, making correct operation impossible. To prevent this, or if this occurs, let the unit sit for one or two hours at the new room temperature before using.

Cleaning the unit

To clean the unit, wipe gently with a soft dry cloth. Do not wipe with chemical cleaning cloths, benzene, paint thinner, ethyl alcohol or other chemical agents to clean the unit as they could damage the surface.

2 – Parts of the US-144MKII

Top panel

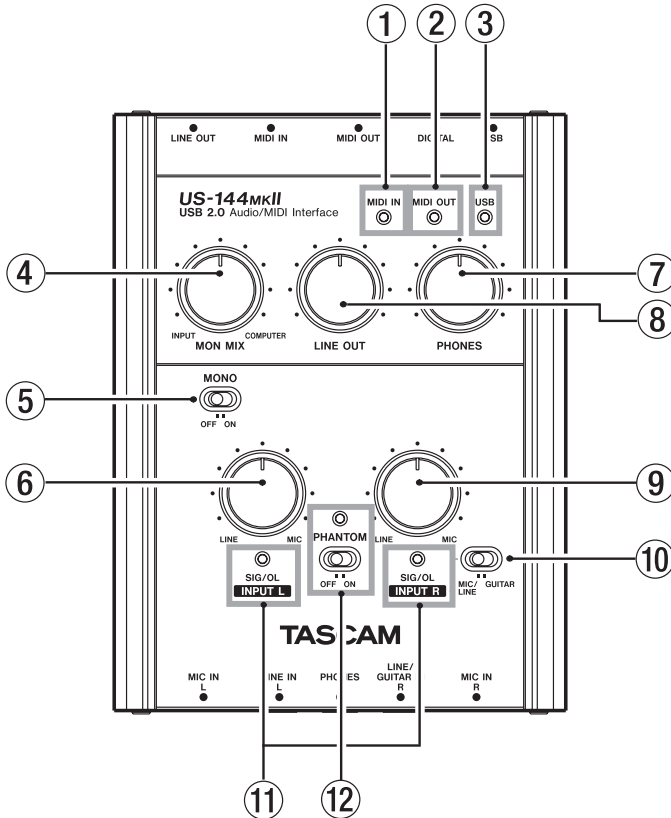

① **MIDI IN indicator** Lights when MIDI data is being received at the **MIDI IN** connector.

NOTE

A device that transmits the MIDI Active Sense message will cause this indicator to blink constantly.

② **MIDI OUT indicator** Lights when MIDI data is being transmitted from the **MIDI OUT** connector.

③ **USB indicator** Lights to indicate a valid USB connection to the host computer.

2 – Parts of the US-144MKII

④ **MON MIX balance knob** Controls the balance of the signal sources being output from the **LINE OUT** jacks and the **PHONES** jack. When this knob is turned to the **INPUT** side, the signal being input to the US-144MKII (from the **MIC IN** jacks, or 1/4" **LINE IN** jacks) will be output. When this knob is turned to the **COMPUTER** side, the output signal received from the computer via USB will be output.

⑤ **MONO switch** Turn this switch **ON** if you want to monitor in monaural. This switch affects only the **MIC/LINE** input signal.

⑥ **INPUT L knob** Adjust the level of the audio signal being input to the **MIC IN L** jacks and **LINE IN L** jacks.

⑦ **PHONES level knob** Controls the output level of the **PHONES** jack.

CAUTION

Use the PHONES knob to minimize the volume before connecting headphones. Failure to do so could cause a sudden burst of loud noise, which might result in hearing damage, for example.

⑧ **LINE OUT level knob** Controls the output level of the **LINE OUT** jacks.

⑨ **INPUT R knob** Adjust the level of the audio signal being input to the **MIC IN R** jacks and **LINE IN R** jacks.

⑩ **MIC/LINE-GUITAR select switch** Set this switch as appropriate for the input source you have connected to the **LINE/GUITAR IN R** jack. Use the **GUITAR** position if you have directly connected an electric guitar or electric bass. Use the **MIC/LINE** position if you have connected an electronic musical instrument, audio device, or mic.

⑪ **SIG/OL indicators** Light when signals are being input to the input channels (**L, R**). They will light green to indicate a signal is present, and will light red immediately before distortion occurs.

These indicators will light green when the maximum level is between -30 dB and -2 dB. The indicators will light red when the maximum level is within -2 dB.

⑫ **PHANTOM switch/indicator** Turns on the +48V phantom power supplied to the **MIC IN** jacks.

The indicator lights when the **PHANTOM** switch is **ON**.

CAUTION

- Use the **PHONES** and **LINE OUT** knobs to minimize the volume before turning the **PHANTOM** switch **ON** or **OFF**. Depending on the mic, loud noises might be produced and damage could be caused to equipment or to people's hearing.
- Microphones should not be connected to or disconnected from the US-144MKII with phantom power switched on.
- Turn this switch on only if you are using condenser microphones that require phantom power.
- Unbalanced dynamic microphones should never be connected to phantom-powered connectors.
- Please note that if you are operating the unit with a battery-powered laptop computer, the battery life of the computer will be reduced if the **PHANTOM** switch is on.

2 – Parts of the US-144MKII

Front panel

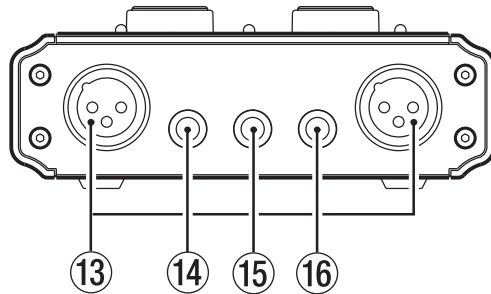

⑬ **MIC IN (L, R) jacks** (XLR balanced)

These are analog mic input jacks. The wiring is as follows: pin 1 = ground, pin 2 = hot, pin 3 = cold.

⑭ **LINE IN L jack** (TRS 1/4" phone jack)

These are balanced line input jacks.

⑮ **PHONES jack** (stereo 1/4" phone) This is a headphone output jack.

CAUTION

Use the PHONES knob to minimize the volume before connecting headphones. Failure to do so could cause a sudden burst of loud noise, which might result in hearing damage, for example.

⑯ **LINE IN R/GUITAR IN jack** (TRS 1/4" phone jacks)

These are balanced line input jacks. This also accommodates guitar input. If the top panel **MIC/LINE-GUITAR** select switch is in the **GUITAR** position, this operates as an unbalanced input jack for guitar. If the **MIC/LINE-GUITAR** select switch is in the **MIC/LINE** position, this operates as a balanced input jack. (Sleeve = ground, tip = hot, ring = cold)

2 – Parts of the US-144MKII

Rear panel

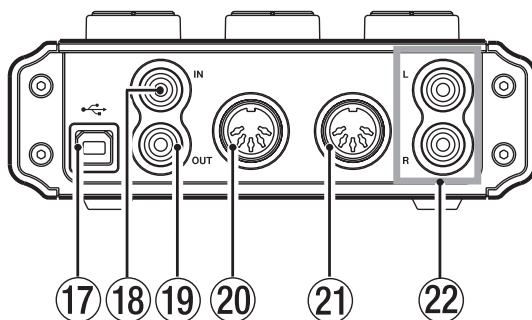

⑰ **USB connector** Use the provided USB cable to connect this to the host computer's USB 2.0 port.

NOTE

- If the US-144MKII is operating with a USB 1.1 (USB 2.0 Full Speed) connection, the sample rate choices will be limited to 44.1 kHz and 48 kHz.
- If the unit is operating with a USB 1.1 (USB 2.0 Full Speed) connection, the transfer of audio data with the computer by USB is limited to either 2 channels of input or 2 channels of output.
- The US-144MKII obtains power from the host computer via the USB cable. In rare cases, a computer's USB port may not be able to supply enough power to operate the US-144MKII. If this occurs, consider purchasing a USB 2.0 hub that comes with its own external power supply.

⑱ **DIGITAL IN (COAXIAL) connector** Coaxial digital input jack that conforms to the IEC60958 (S/PDIF) standard for consumer use.

⑲ **DIGITAL OUT connector** Coaxial digital output jack that conforms to the IEC60958 (S/PDIF) standard for consumer use and the IEC60958 (AES/EBU) standard for professional use.

NOTE

Simultaneous input and output at 24-bit/96-kHz is possible with this unit's DIGITAL IN and OUT jacks.

⑳ **MIDI OUT connector** Transmits MIDI messages.

㉑ **MIDI IN connector** Receives MIDI messages.

㉒ **LINE OUT L/R jacks** (RCA connector, unbalanced) These are analog stereo output jacks.

3 – Installation

System requirements

See the TASCAM website for updated information about OS compatibility.

Windows

Windows XP 32-bit SP2/SP3

Windows XP 64-bit SP2

Windows Vista 32-bit SP2

Windows Vista 64-bit SP2

or later

Supported computer system:

Windows compatible computer with a USB port (USB 2.0 is recommended)

- CPU/clock:
Pentium 4 1.4 GHz or faster
AMD Athlon 1.4 GHz or faster
(or equivalent processor)
- Memory:
512 MB or more for Windows XP 32-bit and Windows Vista 32-bit

1 GB or more for Windows XP 64-bit and Windows Vista 64-bit

NOTE

Although this product has been checked for use with typical computers that meet the above operating requirements, we cannot guarantee that it will operate with all computers that meet these requirements. Please be aware that even under the same conditions, processing capability may vary depending on differences of the design and system.

Mac OS X

Supported operating system:

Mac OS X 10.4.11

Mac OS X 10.5.6

or later

Supported computer system:

Apple Macintosh series equipped with a USB port as standard equipment

- CPU/clock:
Power PC G4 1 GHz or faster, or Intel processor
- Memory:
512 MB or more

Installing the driver

In order to use the US-144MKII, you must install the appropriate driver into your computer. As described below, this is an easy process using the CD-ROM included with the US-144MKII.

Driver are updated from time to time. You can download the most recent version of the driver from the TASCAM website <<http://www.tascam.com/>>.

Do not connect the US-144MKII to your computer before you have installed the driver.

CAUTION

- *Handle the enclosed CD-ROM with care. If the disc becomes scratched or dirty, your computer may be unable to read it and the software cannot be installed. If the disc becomes unreadable, a fee will be charged for its replacement.*
- *Never attempt to play the enclosed CD-ROM in a conventional audio CD player, as the resulting noise may damage your speakers or your hearing.*

3 – Installation

Installing the driver for Windows

NOTE

- During driver installation, a warning that “this software ... has not passed Windows Logo testing” will appear. If this message appears, click Continue to proceed with the installation.
- During installation, you must connect, disconnect and reconnect the unit in steps 7, 8 and 9. You should complete each of these installation steps in less than one minute. Installation may fail if you take too much time.

- 1 Confirm that the unit and the PC are not connected by the USB cable.
- 2 Insert the included driver installation CD-ROM into the PC where you will install it.
- 3 Click the “Install Driver” button when the screen below appears. (If this screen does not appear automatically, find and open the “Autorun2.exe” program in the “Autorun” folder on the driver CD-ROM.)



- 4 When the language selection screen (below) appears, select the language you prefer and then click the “OK” button.

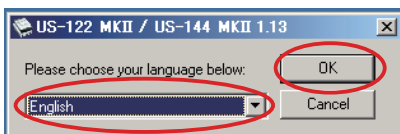

- 5 Click the “Install the Driver” button when the screen below appears.

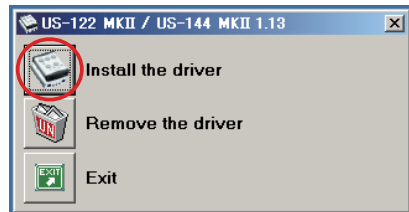

- 6 Read the contents of the License Agreement, and select “I accept the agreement” if you agree to the terms. Next, click the “Install” button to start installation.

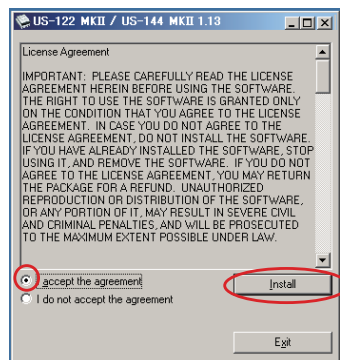

- 7 When the screen below appears, use the supplied USB cable to connect the unit to the PC.



3 – Installation

- 8 When the screen below appears, unplug the connecting USB cable from the unit or the PC.



- 9 When the screen below appears once more, reconnect the unit and the PC with the USB cable.

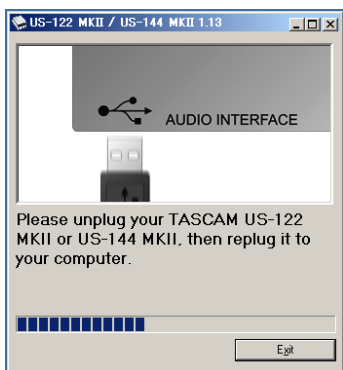

- 10 When the screen below appears, the installation is complete. Click the "Reboot now" button to restart the PC to use the driver.



- 11 After the PC has restarted, open the TASCAM US-122 MKII / US-144 MKII (Start > Control Panel) or US-122 MKII & US-144 MKII Control Panel (Start > All Programs > TASCAM). If the Driver Version, Device and other data appear correctly, the installation has succeeded.



3 – Installation

Installing the driver for Mac OS X

- 1 Confirm that the US-144MKII is not connected to the computer.
- 2 Double-click the "US-122MKII_US-144MKII_1.14.dmg" on the included CD-ROM. The "TASCAM_US-122MKII_US-144MKII_1.14.mpkg" is created on the desktop.
- 3 Double-click the "TASCAM_US-122MKII_US-144MKII_1.14.mpkg" on the desktop to launch the installer.
- 4 Follow the instructions on the screen to conduct the installation.
- 5 Restart the computer and then connect the unit.

Uninstalling the driver

Windows

There are two ways to uninstall the driver as shown below.

- Using the Installation CD-ROM:
- 1 Follow steps 1 to 4 under "Installing the driver for Windows" (See page 13.)
 - 2 At step 5 of the procedure, click "Remove the driver".

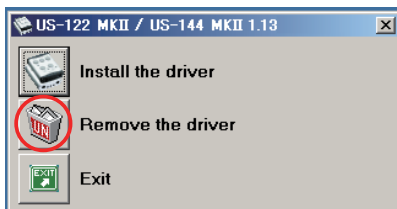

- 3 Follow the instructions on the screen for the remaining procedure.

- Using Windows "Add or Remove Programs"
- 1 Open the "Control Panel" from the "Start" menu.
 - 2 Double click on "Add or Remove programs".
 - 3 Select "US-122 MKII / US-144 MKII" from the list and click "Change or Remove Programs".
 - 4 Follow the instructions on the screen for the remaining procedure.

Mac OS X

- 1 Insert the CD-ROM into the PC and double click "TASCAM US1xx remover" icon.



TASCAM US1xx remover

- 2 Follow the instructions on the screen for the remaining procedure.

Frequently asked installation questions and answers (FAQ)

Windows driver installation

Q: When I connect the unit to a computer, the Windows "Hardware Wizard" appears and I cannot install the driver. Am I making a mistake in the installation procedures?

A: Close the Windows "Hardware Wizard" and disconnect the unit. You must install the driver before connecting this unit. Insert the CD-ROM included with the product. The menu for installing the driver appears automatically.

3 – Installation

Select “Install Driver,” and follow the instructions shown on the screen. If you have downloaded the driver from the TASCAM website (<http://www.tascam.com>), expand the ZIP archive, launch the “setup.exe” file, and follow the instructions on the screen.

Q: I loaded the installation CD-ROM into a Windows computer, but the driver installation menu does not appear. How can I access this menu?

A: The automatic playback settings for the disc drive might be disabled.

Open the CD-ROM using Windows Explorer, and double-click the “Autorun2.exe” file to manually open the installation menu.

Settings on your computer

Here are a few basic points to help you set up your computer for best performance with audio applications.

- Do not run other applications. You will probably use your computer for applications other than audio, but we recommend that you avoid running other applications at the same time you are running audio programs. Processing digital audio places a considerable load on your computer.

This means that if you are running other applications (especially graphics or Internet tools) at the same time as your audio application, the processing may not happen fast enough.

Installing Cubase LE4

For details see the Cubase LE4 Quick Start Guide.

4 – US-144 MKII Control panel settings

Overview

The Control Panel lets you make various settings for the US-144MKII's functionality.

On Windows XP and Windows Vista, the US-122MKII & US-144MKII Control Panel shortcut can be found in the Windows Start menu > Control Panel or the Start menu > All Programs > TASCAM.

On Mac OS X, the US-122MKII & US-144MKII Control Panel is located in the Applications folder. Other useful audio and MIDI settings for Mac OS X can be found in Applications/Utilities/Audio MIDI Setup.



The Control Panel is divided into the following two sections.

Status section

This shows the current status of the driver and the connected hardware.

You cannot edit the settings from this section.

Setting section

You can edit the various settings of the driver.

NOTE

The Mac OS X US-144MKII control panel has no settings.

Control panel settings

Audio Performance

The US-144MKII driver temporarily stores input and output audio sample in buffers. The size of these buffers can be adjusted. A smaller buffer size will reduce the delay when monitoring the audio signal, but will require your computer to perform the processing faster. If the processing does not occur in time (e.g., if other system operations are occurring), you may hear clicks, pops, or dropouts in the audio signal. A larger buffer size provides more safety against such problems caused by other system activities, but will produce greater delay when monitoring the audio signal. You should select the buffer size that works best for your system.

On the Windows version of the US-144MKII Control Panel, the Audio Performance setting permits you to adjust the buffer size that will be used by all audio applications. The lowest latency setting is the minimum buffer size, and the highest latency setting is the maximum buffer size.

On Mac OS X, the buffer size is determined by each audio application. Consequently, there is no Audio Performance setting on the Mac OS X version of the US-144MKII Control Panel. Some applications select the buffer size automatically while others permit the user to select the buffer size. Please consult your audio application's documentation for details.

4 – US-144 MKII Control panel settings

Sample Clock Source

The clock source can be set to “Automatic” or “Internal.”

- Automatic (default): If a clock signal is input through the **DIGITAL IN** jack, it is used. If no signal is input through the **DIGITAL IN** jack, this unit’s internal clock is used.
- Internal: This unit’s internal clock is always used.
- When using digital input, set this to “Automatic.”

Digital Output Format

Set the digital output format to “AES/EBU” or “S/PDIF.”

“ch1 and ch2” and “ch3 and ch4”

This unit sends 4 channels of signals to the computer by USB.

Use these settings to select which of this unit’s inputs signals are sent to each computer input pair.

Select analog inputs or digital inputs.

LINE OUTPUTS and DIGITAL OUTPUT

The computer inputs 4 channels of signals to this unit by USB.

Use these settings to select the signals to be output from this unit’s **LINE OUT** and **DIGITAL OUT** jacks.

Set them to “ch1 and ch2” or “ch3 and ch4.”

NOTE

If you want to output Windows Media Player or iTunes, for example, through this unit’s DIGITAL OUT, set the “DIGITAL OUTPUT” to “ch1 and ch2” in the Control Panel.

USB 1.1 Mode Input Selection

This appears only when operating with USB 1.1.

Set the input source to “analog” or “digital.”



5 – Connections

USB connections

Using the included USB cable, connect the US-144MKII to your computer as shown in the illustration.

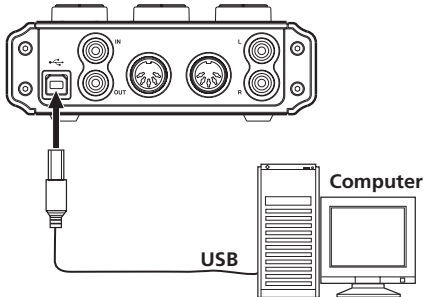

NOTE

Some USB devices access the USB bus frequently. To avoid dropouts and clicks in the audio signal, we strongly recommend that you do not connect other USB devices to the USB bus used by the US-144MKII. USB keyboards and mice are exceptions to this, and will probably not cause problems.

Audio connections

Connect the output signal of your mic, guitar, keyboard, or other audio device to the US-144MKII, where it will be converted into digital audio and sent via USB to your computer. Connect the output of the US-144MKII to your speakers (via an amp) or headphones, so you will be able to monitor the audio signals coming into the US-144MKII or being produced by your computer.

The balance between the input signal from the mic and guitar and the output signal from the computer should be adjusted by the **MON MIX** knob.

NOTE

The US-144MKII has two input channels (L, R), with a **MIC IN** jack (XLR), **LINE IN** and **LINE/GUITAR IN** jack (1/4" phone jack) provided for each channel. Do not connect signals to both of these analog input jacks at the same time. If both are connected, the signal will not be correctly input to the US-144MKII.

Mic

Connect your mics to the **MIC IN (L, R)** jacks (XLR). If you are using a condenser mic that requires phantom power, turn on the **PHANTOM** switch.

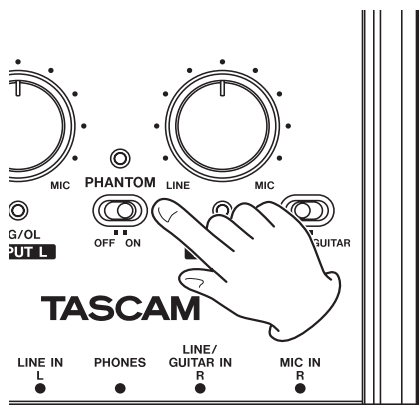
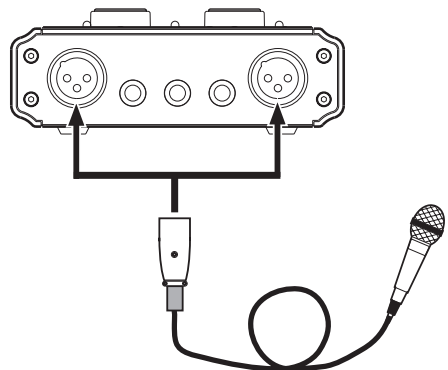

5 – Connections

CAUTION

- Connecting a dynamic mic with an unbalanced connection could damage it if the PHANTOM switch is ON.
- Do not connect or disconnect mics when the PHANTOM switch is ON. Doing so could cause loud noise or damage the equipment.
- Use the PHONES and LINE OUT knobs to minimize the volume before turning the phantom switch ON or OFF. Depending on the mic, loud noises might be produced and damage could be caused to equipment or to people's hearing.

NOTE

- When the PHANTOM switch is ON (and the unit's power is ON) the PHANTOM indicator lights on the top panel.
- The pin configuration of the unit's XLR connector is:
 - Pin 1 = Ground
 - Pin 2 = Hot
 - Pin 3 = Cold

Guitar

Connect your guitar to the R-channel **LINE/GUITAR IN** jack (1/4" phone jack) on the front panel and set the **MIC/LINE-GUITAR** switch on the top panel to **GUITAR**.

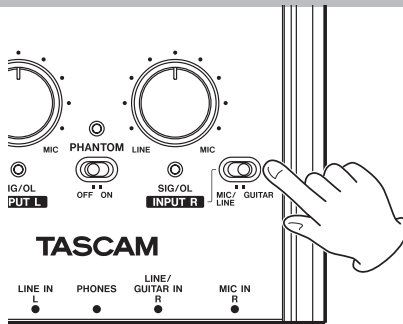
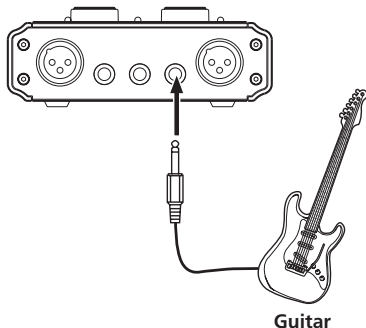

Sound module/MD/CD etc. (digital connection)

Connect the digital audio output of these devices as follows.

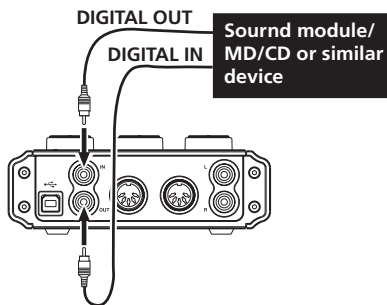

NOTE

- This unit's digital input jack is an RCA pin jack.
- This unit can output either S/PDIF or AES/EBU digital signals. Set the type of output using the control panel.

5 – Connections

Keyboard/drum machine/sound module/cassette deck/MD/CD etc. (analog connection)

Connect the analog audio output of these devices to the **LINE IN L** or **LINE/GUITAR IN R** jacks (1/4" phone jack) on the front panel. If you use the **R**-channel, set the **MIC/LINE-GUITAR** switch on the top panel to **MIC/LINE**.

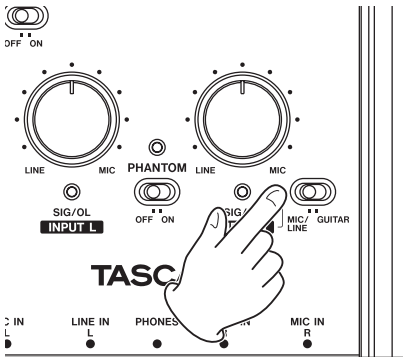
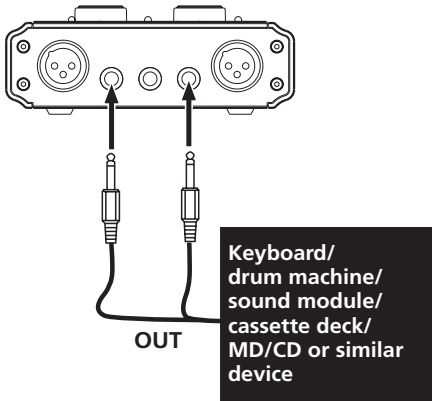

Analog record player

The output of an analog record player cannot be connected directly to the US-144MKII. You must connect a phono amp between your analog record player and the US-144MKII. (Alternatively, you can connect it via an audio amp that has **PHONO** inputs.)

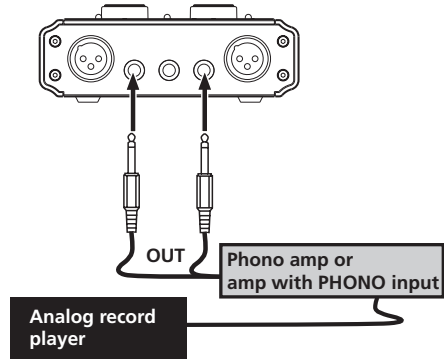

Monitor speakers

Connect monitor speakers (powered speakers or an amplifier and speakers) to the **LINE OUT** jacks on the rear panel.

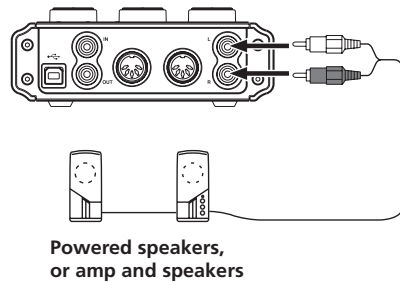

5 – Connections

Headphones

Connect headphones to the **PHONES** jack (standard stereo phone jack) on the front panel.

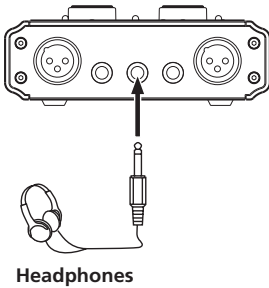

MIDI connections

Connect your sound module, keyboard/synthesizer, drum machine, or other MIDI device to the US-144MKII as shown below.

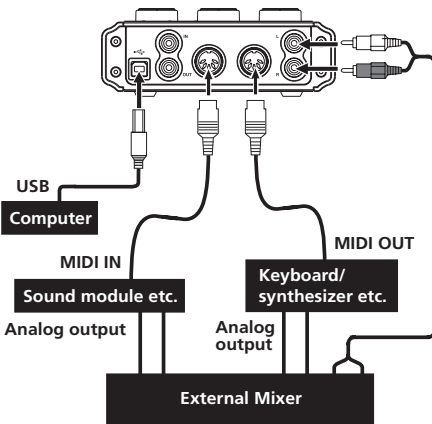

If you want to monitor the sound of a sound module, keyboard/synthesizer or drum machine, connect the output of that device to this unit's **LINE IN**. Alternatively, to monitor using an external mixer, connect the outputs

of that device and the **LINE OUT** jacks of this unit to the external mixer inputs.

NOTE

MIDI connections do not transmit audio. They only carry instructions about what and when to play, so you must also connect the audio output jacks of a device to hear it.

You can use the **MIDI IN/MIDI OUT** connectors on the rear panel to transmit and receive MTC (MIDI Time Code). This allows the MTC-compatible DAW (Digital Audio Workstation) computer application to synchronize with your MIDI equipment.

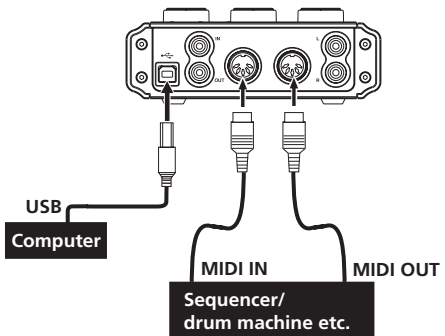

CAUTION

- The **MIDI IN** indicator and **USB** indicator sometimes stay lit even after the connected computer has been shut down. This is because some computers continue to provide power through the USB cable even when they are shut down.
- When the **MIDI IN** jack is receiving any kind of MIDI data, the **MIDI IN** indicator lights. If a device that sends MIDI Active Sensing messages is connected, this indicator will continuously blink. To avoid this, disable the MIDI Active Sensing on the connected device.

5 – Connections

- *When using Windows Media Player, if the MIDI music playback output destination (default device) is set to "Microsoft GS Wavetable SW Synth" in the "Sounds and Audio Devices" part of the "Control Panel," you can listen to MIDI performances through this unit's LINE OUT and PHONES output.*

6 – Application Guide

In this chapter, we explain how to set some audio applications for use with this unit.

Windows XP and Windows Media Player

- 1 Close all applications and then open the “Control Panel” from the “Start” menu.
- 2 Open “Sounds and Audio Devices” or “Sounds and Multimedia.”

NOTE

If you do not see either of the items above, click “Sounds, Speech, and Audio Devices” and one will appear.



Sounds and Audio Devices

- 3 Click the “Audio” tab, and set the “Default device:” for “Sound playback” to “TASCAM US-144MK2.”

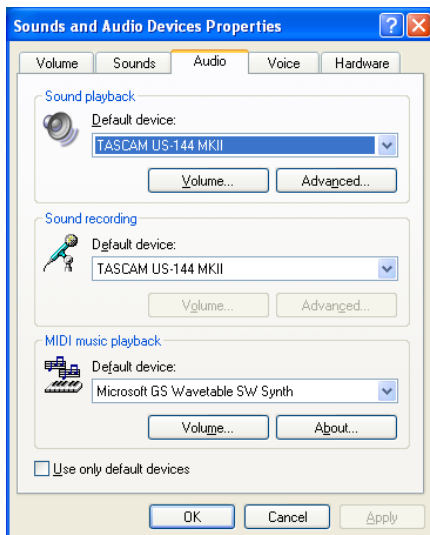

- 4 Click “OK.”

- 5 Start Windows Media Player, select an audio file and begin playback.

NOTE

- If you change the setting while Windows Media Player is running, the software will not recognize that the device has been changed. In this case, restart Windows Media Player.
- If you still cannot hear sound after making the settings and completing the procedures above, restart the computer.
- If you make this setting, sound will be output through this unit, but no sound will be output by the computer’s speakers or headphone jack.
- If you want to output Windows Media Player through this unit’s DIGITAL OUT, set the “DIGITAL OUTPUT” to “ch1 and ch2” in the Control Panel.

6 – Application Guide

Windows Vista and Windows Media Player

- 1 Close all applications and then open the “Control Panel” from the “Start” menu.
- 2 Open “Sound.”

NOTE

If the above item does not appear, click “Hardware and Sound” and it will appear.



Sound

- 3 Click the “Playback” tab, click “Speakers US-144MK2” and click the “Set Default” button. This moves the green check mark to “Speakers US-144MK2.”

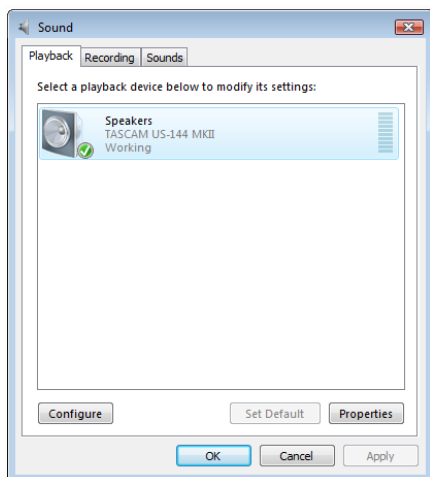

- 4 Click “OK.”
- 5 Start Windows Media Player, select an audio file and begin playback.

NOTE

- If you change the setting while Windows Media Player is running, the software will not recognize that the device has been changed. In this case, restart Windows Media Player.
- If you still cannot hear sound after making the settings and completing the procedures above, restart the computer.
- If you make this setting, sound will be output through this unit, but no sound will be output by the computer's speakers or headphone jack.
- If you want to output Windows Media Player through this unit's DIGITAL OUT, set the “DIGITAL OUTPUT” to “ch1 and ch2” in the Control Panel.

6 – Application Guide

Mac OS X and iTunes

- 1 Open “System Preferences...” from the Apple menu.

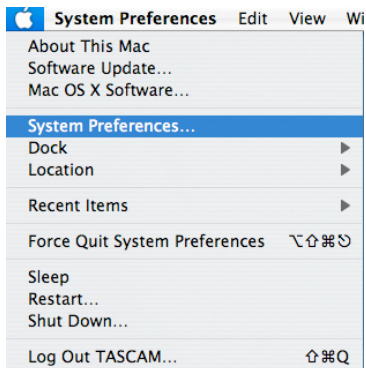

- 2 Click “Sound” in the “System Preferences” window.

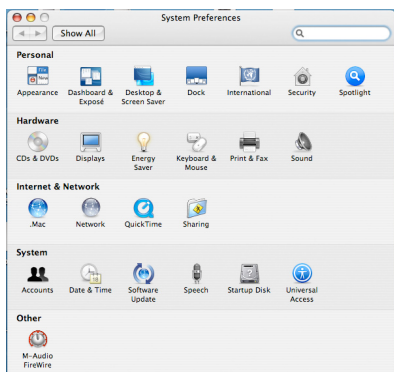

- 3 Click the “Output” tab, and select “US-144MKII: Output” under “Choose a device for sound output.”

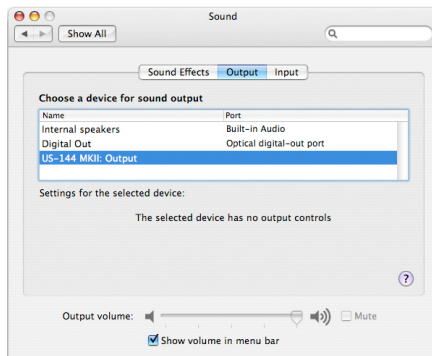

NOTE

If you want to output iTunes through this unit's DIGITAL OUT, set the "DIGITAL OUTPUT" to "ch1 and ch2" in the Control Panel.

Cubase LE4

See the included Cubase LE4 Quick Start Guide for information about making settings in this software.

7 – MIDI Implementation Chart

Function		Transmitted	Received	Remarks
Basic Channel	At power ON	X	X	Through
	Changed	X	X	
Mode	At power ON	X	X	Through
	Messages Altered	X *****	X	
Note Number		X	X	Through
	Range	*****		
Velocity	Note ON	X	X	Through
	Note OFF	X	X	
After Touch	Polyphonic	X	X	Through
	Channel	X	X	
Pitch Bender		X	X	Through
Control Change		X	X	Through
Program Change		X	X	Through
	Range #	*****		
System Exclusive		X	X	Through
System Common	:Song Pos	X	X	Through
	:Song Sel	X	X	
	:Tune	X	X	
System Real Time	:Clock	X	X	Through
	:Commands	X	X	
Other	:Local on/off	X	X	Through
	:All note off	X	X	
	:Active sensing	X	X	
	:Reset	X	X	
Notes				

Mode 1: Omni on, Poly

Mode 2: Omni on, Mono

O: Yes

Mode 3: Omni off, Poly

Mode 4: Omni off, Mono

X: No

8 – Troubleshooting

Please read this chapter if you are unable to use the unit properly even after setting it up following the procedures in this manual.

If you are still unable to resolve your problems please contact TASCAM customer support with the following information about the operating environment and details about the trouble.

Operating environment

- Computer manufacturer:
- Model:
- CPU:
- Installed memory:
- OS:
- DAW:
- Antivirus software use:
- Wireless LAN use:
- **Installation is failing. Installation completed, but the computer does not recognize it.**

If some trouble is causing installation to fail, or installation completes but the computer does not recognize the unit, check the following.

- 1) Is the unit's USB indicator lit green?
If the USB indicator is not lit, confirm that the USB cable is properly connected.

NOTE

Always use the included USB cable.

- 2) Change the USB port
Since the unit may not properly function with some USB ports, try connecting to a different (built-in) USB port, and reinstall the driver.

NOTE

- *Try again after disconnecting other USB devices. (Keyboards and mice can be left connected.)*
 - *Do not use a USB hub. Always connect the unit directly to a USB port on the computer (built-in).*
- 3) Stop other software that is running in the background
Since antivirus software and other software that runs in the background can interfere with installation, stop them before beginning installation.

See page 12 of this manual for how to install and uninstall the driver.

- **There is no sound even when audio is playing back.**

The audio output must be set on the computer.

Please confirm the following while the unit is connected to the computer.

If you make the following settings, sound will be output through this unit, but no sound will be output by the computer's speakers or headphone jack.

Windows XP

- 1 **Shut down all applications, and open the "Control Panel" from the "Start Menu."**
- 2 **Open "Sounds and Audio Devices"**

NOTE

If you cannot find the above item, click "Sounds, Speech, and Audio Devices" and it will appear.

8 – Troubleshooting

- 3 Click the **Audio tab**, and set the “Default device:” for “Sound playback” and “Sound recording” to “TASCAM US-144MKII.”

Windows Vista

- 1 Shut down all applications, and open the “Control Panel” from the “Start” menu.
- 2 Open “Sound.”

NOTE

If the above item does not appear, click “Hardware and Sound” and it will appear.

- 3 Click the “Playback” tab, right-click “Speakers US-144MK2” and click the “Set Default” button.

Mac OS X

- 1 Shut down all applications and open “System Preferences.”
- 2 Open “Sound.”
- 3 From the output tab, select “US-144MKII output.”

After completing the settings, restart the computer and check the playback sound.

Depending on the application you are using, it might also be necessary to make other device settings in addition to those above.

In particular, since DAW software operates using audio engines that are different from the OS settings, confirm the DAW driver settings first after installing the driver for this unit.

Please see the manual for the application that you are using for detailed setting procedures.

For the bundled Cubase LE4 software, see the manual on the included CD-ROM.

- The sound breaks up or there is noise.

The load on the computer causes sound to break up and noise to occur.

Methods to reduce the load on the computer are introduced below.

- 1) If a wireless LAN, antivirus software and other software that run in the background are operating, they regularly put burdens on the computer, which can cause sound to break up and noise.

Stop wireless LAN transmission, antivirus software and other software running in the background when using this unit.

- 2) Set the buffer size in the DAW software that you are using to a larger value.

NOTE

- Consult the maker of your DAW software for methods to reduce its burden on your computer.
 - If you are not using a DAW, try setting the “Audio Performance” sitting in the driver for this unit to “High Latency.”
- 3) Change the settings of your computer so that they are optimal for audio processing.

Windows XP

- 1 Right-click “My Computer” and select “Properties.”
- 2 Click the “Advanced” tab.
- 3 Click “Settings” in the “Performance” section.
- 4 On the “Performance Option” screen, select the “Adjust for Best Performance” option.

8 – Troubleshooting

Windows Vista

a) Turn Aero off.

- 1 **Right-click the desktop and select “Personalize” to open the “Personalize appearance and sounds” screen.**
- 2 **Choose “Window Color and Appearance” and then click “Open classic appearance properties for more options.”**
- 3 **Select “Windows Vista Basic” or any option other than “Windows Aero.”**

b) Performance settings

- 1 **Right-click “Computer,” select “Properties,” and then click “Advanced system settings.”**
- 2 **Click the “Advanced” tab.**
- 3 **Click “Settings” in the “Performance” section.**
- 4 **On the “Performance Option” screen, select the “Adjust for Best Performance” option.**

Mac OS X

- 1 **Open “System Preferences” and select “Energy Saver.”**
- 2 **Click the “Sleep” tab.**
- 3 **Set “Put the computer to sleep when it is inactive for:” to “Never.”**
- 4 **Set “Put the display(s) to sleep when the computer is inactive for:” to “Never.”**
- 5 **Click the “Options” tab.**

If a “Processor performance” setting is available, set it to “Highest.”

NOTE

Depending on the Mac OS version and model this setting might not be available.

• Questions related to Cubase LE4

Since Cubase LE4 is a product provided by Steinberg Media Technologies GmbH, it is not supported by TASCAM.

Please use the Cubase LE4 Help menu (and access the PDF manuals) for information about how to use this software.

9 – Specifications

Input/output ratings

Analog audio input/output

MIC IN (Balanced) terminal

Connector: XLR-3-31 equivalent

Nominal input level:

–58 dBu (When **INPUT** knob is set to

MIC)

–14 dBu (When **INPUT** knob is set to

LINE)

Maximum input level:

+2 dBu (When **INPUT** knob is set to

LINE)

Input impedance: 2.2 k Ω

LINE IN (Balanced) terminal

Connector: TRS Standard phone jack

L channel, and R channel with **MIC/LINE-GUITAR** set to **MIC/LINE**

Nominal input level:

–40 dBu (When **INPUT** knob is set to **MIC**)

+4 dBu (When **INPUT** knob is set to **LINE**)

Maximum input level:

+20 dBu (When **INPUT** knob is set to **LINE**)

Input impedance: 15 k Ω

R channel with **MIC/LINE-GUITAR** set to **GUITAR**

Nominal input level:

–51 dBV (When **INPUT** knob is set to **MIC**)

–7 dBV (When **INPUT** knob is set to **LINE**)

Maximum input level:

+9 dBV (When **INPUT** knob is set to **LINE**)

Input impedance: 1 M Ω

LINE OUT (Unbalanced) terminal

Connector: RCA pin jack

Nominal output level: –10 dBV

Maximum output level: +6 dBV

Output impedance: 200 Ω

PHONES terminal:

Connector: Standard stereo phone jack

Maximum output level: 18 mW + 18 mW or more (THD+N less than 0.1%, 32 Ω load)

Digital audio input/output

DIGITAL IN (COAXIAL) jack

Connector: RCA pin jack

Compatible signal format: IEC60958 (S/PDIF) for consumer use

DIGITAL OUT (COAXIAL) jack

Connector: RCA pin jack

Compatible signal format: IEC60958 (S/PDIF) for consumer use and IEC60958 (AES/EBU) for professional use

Switch using control panel

9 – Specifications

Control input/output

MIDI IN terminal

Connector: DIN 5 pin

Format: Standard MIDI format

MIDI OUT terminal

Connector: DIN 5 pin

Format: Standard MIDI format

USB terminal

Connector: USB B type 4 pin

Format:

USB 2.0 High speed (480 MHz)

USB 2.0 Full speed
(12 MHz USB 1.1 equivalent)

Audio performance

Frequency response

20 Hz - 20 kHz, +0.5 dB/-1.0 dB (44.1/48 kHz) (MIC to LINE OUT)

20 Hz - 40 kHz, +0.5/-1.5 dB (88.2/96 kHz) (MIC to LINE OUT)

Signal-to-noise ratio (LINE IN to LINE OUT)

Through ADC and DAC: 98 dB
(When INPUT knob is set to LINE, 20 kHz LPF + A-weighted)

Direct monitor: 107 dB
(When INPUT knob is set to LINE, 20 kHz LPF + A-weighted)

Total harmonic distortion (LINE IN to LINE OUT)

Through ADC and DAC: Less than 0.0045%
(When INPUT knob is set to LINE, 1 kHz +20 dBu input, 20 kHz LPF)

Direct monitor: Less than 0.002%
(When INPUT knob is set to LINE, 1 kHz, +20 dBu input, 20 kHz LPF)

Computer requirements

See the TASCAM website for updated information about OS compatibility.

Windows

Supported Operating system

Windows:

- Windows XP 32 bit SP2/SP3
- Windows XP 64 bit SP2
- Windows Vista 32 bit SP2
- Windows Vista 64 bit SP2
- or later

Supported computer system

Windows compatible computer with a USB port (USB 2.0 is recommended)

- CPU/clock:
 - Pentium 4 1.4 GHz or faster
 - AMD Athlon 1.4 GHz or faster
 - (or equivalent processor)
- Memory:
 - 512 MB or more for Windows XP 32-bit and Windows Vista 32-bit
 - 1 GB or more for Windows XP 64-bit and Windows Vista 64-bit

9 – Specifications

Macintosh

Supported operating system:

Mac OS X 10.4.11
Mac OS X 10.5.6
or later

Supported computer system:

Apple Macintosh series equipped with a USB port as standard equipment

- CPU/clock:
Power PC G4 1 GHz or faster, or Intel processor
- Memory:
512 MB or more

General

Sampling frequency

44.1/48/88.2/96 kHz

Sampling bit rate

16/24 bit

Power

Supplied via USB (5V, maximum current 500 mA)

Power consumption

2.5 W

Dimensions

135.4 x 179 x 47 mm (W x H x D)

Weight

0.7 kg

Operating temperature

5 to 35 °C

Bundled software

Cubase LE4 (for Windows or Macintosh)

9 – Specifications

Dimensions

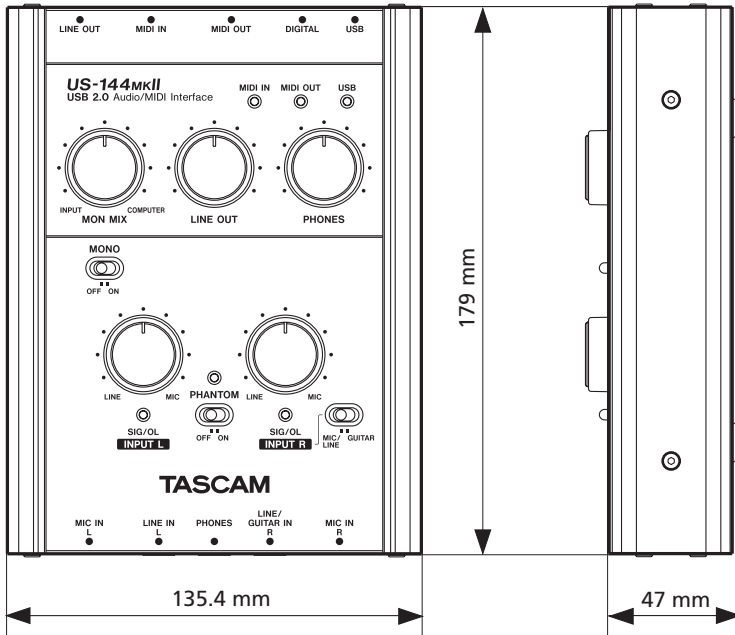

- Illustrations and other depictions may differ in part from the actual product.
- Specifications and external appearance may be changed without notification to improve the product.

TASCAM[®]
TEAC PROFESSIONAL

US-144MK II

TEAC CORPORATION

Phone: +81-42-356-9143
1-47 Ochiai, Tama-shi, Tokyo 206-8530, Japan

www.tascam.jp

TEAC AMERICA, INC.

Phone: +1-323-726-0303
7733 Telegraph Road, Montebello, California 90640 USA

www.tascam.com

TEAC CANADA LTD.

Phone: +1905-890-8008 Facsimile: +1905-890-9888
5939 Wallace Street, Mississauga, Ontario L4Z 1Z8, Canada

www.tascam.com

TEAC MEXICO, S.A. de C.V.

Phone: +52-55-5010-6000
Río Churubusco 364, Colonia Del Carmen, Delegación Coyoacán, CP 04100, México DF, México

www.teacmexico.net

TEAC UK LIMITED

Phone: +44-8451-302511
Suites 19 & 20, Building 6, Croxley Green Business Park, Hatters Lane, Watford, Hertfordshire, WD18 8TE, UK

www.tascam.co.uk

TEAC EUROPE GmbH

Phone: +49-611-71580
Bahnstrasse 12, 65205 Wiesbaden-Erbenheim, Germany

www.tascam.de

Printed in China

Free Manuals Download Website

<http://myh66.com>

<http://usermanuals.us>

<http://www.somanuals.com>

<http://www.4manuals.cc>

<http://www.manual-lib.com>

<http://www.404manual.com>

<http://www.luxmanual.com>

<http://aubethermostatmanual.com>

Golf course search by state

<http://golfingnear.com>

Email search by domain

<http://emailbydomain.com>

Auto manuals search

<http://auto.somanuals.com>

TV manuals search

<http://tv.somanuals.com>