

TASCAM

TEAC Professional Division

MINI STUDIO PORTA 02

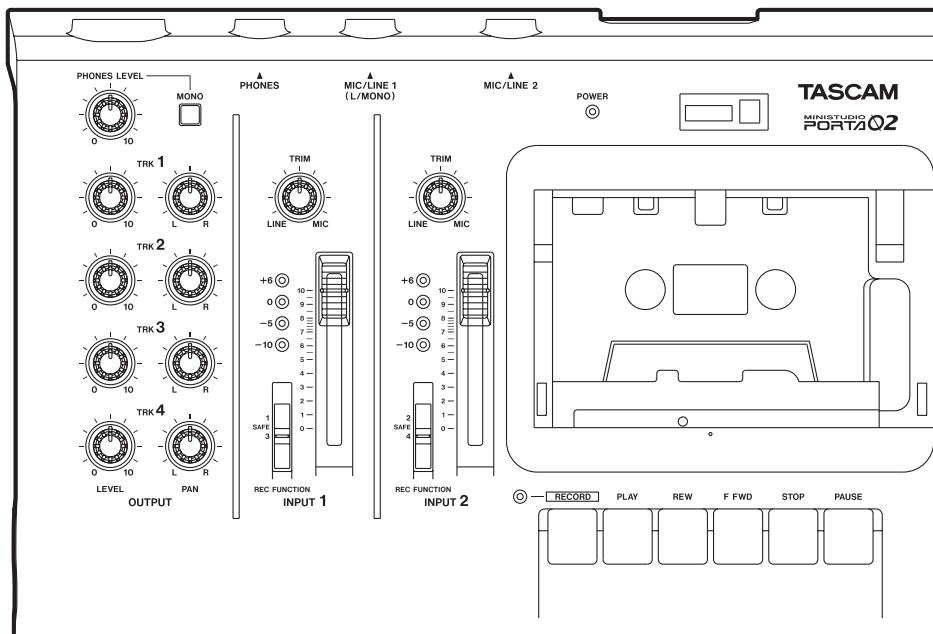

OWNER'S MANUAL

9101411800

Table of Contents

Important Safety Instructions	3
1. An introduction to the Porta02	4
1.1 Multitrack recording – a brief introduction.....	4
1.2 Some safety notes and precautions	5
1.3 What you need to make recordings.....	8
1.4 Connecting the Porta02.....	8
2. Parts of the Porta02	9
3. Making your first recording.....	13
3.1 Setting up	13
3.2 Getting ready.....	13
3.3 Setting the level.....	14
3.4 Recording the first track	15
3.5 Recording the next track	16
3.6 Recording the stereo backing	17
3.7 Mixdown	18
4. Hints and advanced tips	20
4.1 Recording techniques.....	20
4.2 Mixdown	21
5. Troubleshooting.....	22
6. Specifications	23



CAUTION
RISK OF ELECTRIC SHOCK
DO NOT OPEN



CAUTION: TO REDUCE THE RISK OF ELECTRIC SHOCK, DO NOT REMOVE COVER (OR BACK). NO USER-SERVICEABLE PARTS INSIDE. REFER SERVICING TO QUALIFIED SERVICE PERSONNEL.



The lightning flash with arrowhead symbol, within an equilateral triangle, is intended to alert the user to the presence of uninsulated “dangerous voltage” within the product’s enclosure that may be of sufficient magnitude to constitute a risk of electric shock to persons.



The exclamation point within an equilateral triangle is intended to alert the user to the presence of important operating and maintenance (servicing) instructions in the literature accompanying the appliance.

This appliance has a serial number located on the rear panel. Please record the model number and serial number and retain them for your records.

Model number _____
Serial number _____

WARNING: TO PREVENT FIRE OR SHOCK HAZARD, DO NOT EXPOSE THIS APPLIANCE TO RAIN OR MOISTURE.

Important Safety Instructions

CAUTION:

- Read all of these Instructions.
- Save these Instructions for later use.
- Follow all Warnings and Instructions marked on the audio equipment.

- 1) Read Instructions** — All the safety and operating instructions should be read before the product is operated.
- 2) Retain Instructions** — The safety and operating instructions should be retained for future reference.
- 3) Heed Warnings** — All warnings on the product and in the operating instructions should be adhered to.
- 4) Follow Instructions** — All operating and use instructions should be followed.
- 5) Cleaning** — Unplug this product from the wall outlet before cleaning. Do not use liquid cleaners or aerosol cleaners. Use a damp cloth for cleaning.
- 6) Attachments** — Do not use attachments not recommended by the product manufacturer as they may cause hazards.
- 7) Water and Moisture** — Do not use this product near water — for example, near a bath tub, wash bowl, kitchen sink, or laundry tub; in a wet basement; or near a swimming pool; and the like.
- 8) Accessories** — Do not place this product on an unstable cart, stand, tripod, bracket, or table. The product may fall, causing serious injury to a child or adult, and serious damage to the product. Use only with a cart, stand, tripod, bracket, or table recommended by the manufacturer, or sold with the product. Any mounting of the product should follow the manufacturer's instructions, and should use a mounting accessory recommended by the manufacturer.
- 9)** A product and cart combination should be moved with care. Quick stops, excessive force, and uneven surfaces may cause the product and cart combination to overturn.



10) Ventilation — Slots and openings in the cabinet are provided for ventilation and to ensure reliable operation of the product and to protect it from overheating, and these openings must not be blocked or covered. The openings should never be blocked by placing the product on a bed, sofa, rug, or other similar surface. This product should not be placed in a built-in installation such as a bookcase or rack unless proper ventilation is provided or the manufacturer's instructions have been adhered to.

11) Power Sources — This product should be operated only from the type of power source indicated on the marking label. If you are not sure of the type of power supply to your home, consult your product dealer or local power company. For products intended to operate from battery power, or other sources, refer to the operating instructions.

12) Grounding or Polarization — This product may be equipped with a polarized alternating-current line plug (a plug having one blade wider than the other). This plug will fit into the power outlet only one way. This is a safety feature. If you are unable to insert the plug fully into the outlet, try reversing the plug. If the plug should still fail to fit, contact your electrician to replace your obsolete outlet. Do not defeat the safety purpose of the polarized plug.

13) Power-Cord Protection — Power-supply cords should be routed so that they are not likely to be walked on or pinched by items placed upon or against them, paying particular attention to cords at plugs, convenience receptacles, and the point where they exit from the product.

14) Outdoor Antenna Grounding — If an outside antenna or cable system is connected to the product, be sure the antenna or cable system is grounded so as to provide some protection against voltage surges and built-up static charges. Article 810 of the National Electrical Code, ANSI/NFPA 70, provides information with regard to proper grounding of the mast and supporting structure, grounding of the lead-in wire to an antenna discharge unit, size of grounding conductors, location of antenna-discharge unit, connection to grounding electrodes, and requirements for the grounding electrode.

"Note to CATV system installer:

This reminder is provided to call the CATV system installer's attention to Section 820-40 of the NEC which provides guidelines for proper grounding and, in particular, specifies that the cable ground shall be connected to the grounding system of the building, as close to the point of cable entry as practical.

Example of Antenna Grounding as per National Electrical Code, ANSI/NFPA 70

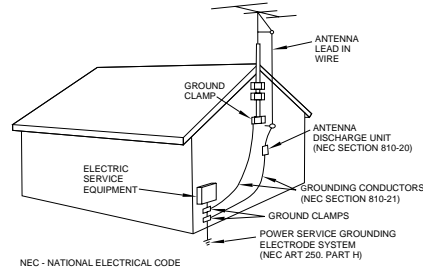

15) Lightning — For added protection for this product during a lightning storm, or when it is left unattended and unused for long periods of time, unplug it from the wall outlet and disconnect the antenna or cable system. This will prevent damage to the product due to lightning and power-line surges.

16) Power Lines — An outside antenna system should not be located in the vicinity of overhead power lines or other electric light or power circuits, or where it can fall into such power lines or circuits. When installing an outside antenna system, extreme care should be taken to keep from touching such power lines or circuits as contact with them might be fatal.

17) Overloading — Do not overload wall outlets, extension cords, or integral convenience receptacles as this can result in risk of fire or electric shock.

18) Object and Liquid Entry — Never push objects of any kind into this product through openings as they may touch dangerous voltage points or short-out parts that could result in a fire or electric shock. Never spill liquid of any kind on the product.

19) Servicing — Do not attempt to service this product yourself as opening or removing covers may expose you to dangerous voltage or other hazards. Refer all servicing to qualified service personnel.

20) Damage Requiring Service — Unplug this product from the wall outlet and refer servicing to qualified service personnel under the following conditions:

- a) when the power-supply cord or plug is damaged.
- b) if liquid has been spilled, or objects have fallen into the product.
- c) if the product has been exposed to rain or water.
- d) if the product does not operate normally by following the operating instructions. Adjust only those controls that are covered by the operating instructions as an improper adjustment of other controls may result in damage and will often require extensive work by a qualified technician to restore the product to its normal operation.
- e) if the product has been dropped or damaged in any way.
- f) when the product exhibits a distinct change in performance — this indicates a need for service.

21) Replacement Parts — When replacement parts are required, be sure the service technician has used replacement parts specified by the manufacturer or have the same characteristics as the original part. Unauthorized substitutions may result in fire, electric shock, or other hazards.

22) Safety Check — Upon completion of any service or repairs to this product, ask the service technician to perform safety checks to determine that the product is in proper operating condition.

23) Wall or Ceiling Mounting — The product should be mounted to a wall or ceiling only as recommended by the manufacturer.

24) Heat — The product should be situated away from heat sources such as radiators, heat registers, stoves, or other products (including amplifiers) that produce heat.

1 – An introduction to the Porta02

The TASCAM Porta02 MiniStudio allows you to produce recordings which are not possible with an ordinary stereo cassette recorder.

We suggest that you read at least this section 1 and also 3, “Making your first

recording” before you start using the Porta02. Spending a little time reading now will save you a lot of time in the future. You can read the rest of the manual at any time.

1.1 Multitrack recording – a brief introduction

This section gives you a brief introduction to some of the terms and techniques used in recording. If you are unfamiliar with these terms, you may find it useful

to read through this section so that you understand the rest of the manual, which uses the terms explained here.

1.1.1 Multitrack recorders

When you listen to a commercial recording (CD, cassette, etc.), it is quite probable that the different parts of the piece will have been recorded at different times.

This is done by “multitracking”—taking the different sounds, feeding them through a mixer’s inputs (“channels”) and recording them on a special tape recorder which splits the tape into “stripes”, each stripe being used for a different part of the music.

These stripes are called “tracks”, and the parts recorded on them may also be called “tracks”. Since there are many tracks on a tape, the term “multitrack” is used to describe these tapes and recorders.

The Porta02 allows you to record up to 4 tracks on inexpensive Type II (chrome) cassettes using the same principle as larger studios—taking inputs into a mixer’s channels, feeding them into a recorder which can record tracks independently of each other, and building up the song by recording new tracks while listening to what has been recorded before (“monitoring”).

The advantage of working with multitrack recording is that the whole group of musicians does not have to repeat the whole piece if one person makes a mistake.

The illustration below shows you how tracks are arranged on an ordinary stereo cassette tape, as well as on the Porta02

and on A/V cue-equipped cassette recorders.

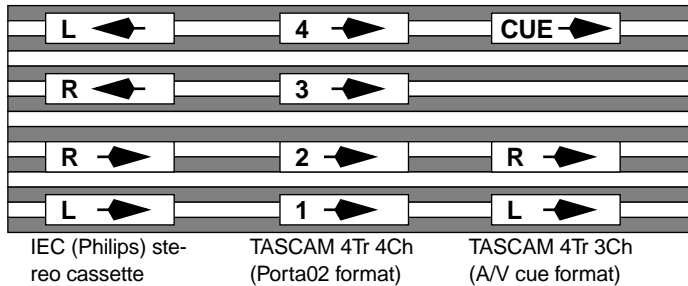

Notice that the stereo cassette arrangement allows you to use both sides of the cassette, by playing the tape in the other direction. The Porta02, however, uses the whole width of the tape. Notice also that

one pair of L and R tracks on the stereo cassette take up the same positions as tracks 1 and 2 on the Porta02. This can be important for your recording projects, as we will see later on.

1.1.2 Mixing down

Another advantage of multitrack recording is that when you come to make the final version (on CD, cassette, etc.), you can adjust the level (volume) of each track, so that the piece sounds the way you want.

As well as adjusting the track levels, you can also adjust the position of each track with regard to the left and right speakers. This is called “panning”, and the controls used to do this are called “panpots”. By

using the panpots, you can make the tracks appear to come from the left or the right speakers or anywhere in the middle.

The technique of converting a multitrack recording to a stereo recording is called “mixing down” to a “stereo master” or “mastering” recorder. The Porta02 includes a mixdown section which allows you to mix to a stereo cassette or MD recorder.

1.2 Some safety notes and precautions

- Always use the PS-P2 power adaptor supplied with the Porta02. If you use any other adaptor, there is a risk of damage, or even fire. Make sure that the input voltage marked on the PS-P2 adaptor matches the power supply you are using. If you are in any doubt, consult your TASCAM dealer.
- Turn off your Porta02 and remove the cassette when you are not using the Porta02. If you will not be using it for an extended period of time, unplug the PS-P2 adaptor.
- When connecting or disconnecting the Porta02 to or from any other equipment, make sure the power to the Porta02 and all other equipment is turned off. This will avoid possible damage to equipment.
- Do not keep your Porta02 in a very hot place. Remember that in sunny weather, the inside of a parked car heats up very quickly. Avoid leaving your Porta02 in such a place.
- Do not spill liquid onto your Porta02. Avoid eating, drinking and smoking near it (smoke particles are bad for

1 An introduction to the Porta02

audio equipment). If any liquid or any objects such as paperclips, guitar picks, etc. fall inside the Porta02, do not try to operate it. Return it to a TASCAM service center for repair.

- If the case of the Porta02 becomes dirty, clean it only with a damp (not wet) cloth, moistened with a little

detergent. Do not use solvents or thinners, etc. to clean the Porta02, as these will damage the surface.

- There are no parts inside the Porta02 that you can repair by yourself. Do not open the Porta02 case or try to make any repairs. Return it to a TASCAM service center for repair.

1.2.1 Tape cassettes

Since the Porta02 uses the whole width of a cassette tape, you can only play and use one side of a cassette. You should try to use either side A or side B for all cassettes, to avoid confusion when changing tapes.

Only use Type II (chrome or CrO₂) cassettes with the Porta02. Find a reliable brand and stick with it. The time you spend creating your multitrack master is worth much more than the small difference in price between cheap and high-quality cassettes. High quality cassettes will cause you fewer problems in the long run.

To avoid having to wind and rewind a lot of tape, use the shortest possible cassettes for your projects. Remember that because you are only using one side of the cassette, the marked length of the tape will be halved (that is, a C60 tape will run for 30 minutes, a C40 for 20 minutes, etc.).

NOTE

Never use C120 cassettes with the Porta02. The tape in these cassettes is thin, and may stretch and break.

Always store cassettes in a safe place (away from the magnetic fields produced by speakers, television sets, computer monitors, etc.).

1.2.2 Record-protecting cassettes

The record-protect tab on a cassette stops you recording on that side when it is removed. The Porta02 also recognizes this protection, and will not allow you to record on the side of a cassette where this tab has been removed.

However, we suggest that you remove **both** tabs when you want to protect a Porta02 cassette. This will stop you putting in the cassette the wrong way round and recording over old material accidentally.

1.2.3 Playing back stereo cassettes

As mentioned earlier, the Porta02 can play back cassettes recorded on a stereo cassette recorder, using tracks 1 and 2. Also, if tracks 1 and 2 have been recorded on the Porta02, these cassettes can be played back on a stereo cassette recorder.

be played back on a stereo cassette recorder.

However, if tracks 3 and 4 are used for recording on the Porta02, these **cannot**

Also, note that if a cassette has been recorded with noise reduction, such as Dolby, etc., it will sound strange when played back on the Porta02. Any tapes (tracks 1 and 2) recorded on the Porta02 should be played back without noise reduction on a stereo recorder.

1.2.4 Cleaning the heads

You should clean the tape heads of the Porta02 regularly to keep it working properly. Dirt and tape oxide buildup on the heads will force the tape away from the tape head gaps that record and playback. Head cleaner will remove the dirt and restore the sound quality.

In addition to affecting performance by coating the heads, and keeping the tape away from the recording and playback gaps, dirt and oxide in the tape path will also act in the same way as very fine sandpaper, which will wear down internal parts of the Porta02, and affect the recording in this way as well.

All of these problems can be avoided if you buy a head cleaning kit such as the TEAC TZ-261 and keep it with your Porta02 for regular use. The kit consists of head cleaner, cleaner for the rubber parts of the Porta02, and cotton-tipped swabs. The cost of such a kit is less than the cost of a couple of high-quality cassettes and will pay for itself in better per-

formance and longer life from your Porta02.

WARNING

Only use head and rubber cleaning fluid and cleaning swabs designed for use with tape recorders. The use of any other cleaning materials may cause damage to the Porta02.

Clean the heads and metal parts of the tape path before every session with the Porta02 and also after every session.

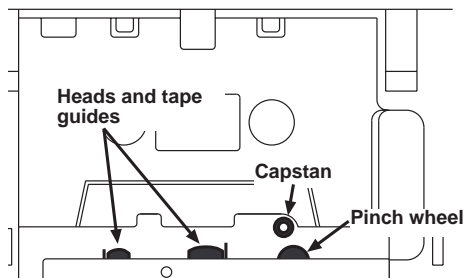

- 1) **Open the tape cassette cover.**
- 2) **Carefully clean the heads and metal parts as shown in the illustration using a swab dipped in the head cleaning fluid.**
- 3) **Dry off the heads with a dry swab.**

1.2.5 Cleaning the pinch roller

You should also clean the rubber pinch roller at regular intervals (at least once each day that you use the Porta02).

- 1) **Open the tape cassette cover.**

- 2) **Press the PLAY key.**

The pinch roller will engage with the capstan shaft and start turning.

- 3) **Press a swab dipped in the rubber cleaning fluid against the right side of the pinch roller.**

If you press the right side of the roller, the swab will not get caught between the roller and capstan.

- 4) **Dry the capstan with a dry swab and make sure that there is no material on the pinch roller or capstan before you insert a cassette.**

1.3 What you need to make recordings

Apart from the Porta02 itself, you will need:

- Some kind of stereo mastering recorder to produce the stereo recordings. This can be a cassette recorder such as the TASCAM 102Mk II or an MD recorder such as the TASCAM MD301. A recorder which does not have recording level controls is not suitable for use as a master recorder.
- You will also need RCA (pin or phono) cables to connect the Porta02 to other equipment.
- Some monitoring equipment (some kind of amplifier and speaker system).
- Headphones, if you intend doing any work with microphones. These will avoid acoustic feedback (“howl-round”) when recording. Additionally, headphones are sometimes useful when panning tracks on mixdown, as you can hear the precise position of each track.
- Of course, you will also need some kind of sound source to record (instrument or microphone, etc.).

1.4 Connecting the Porta02

- 1) **Make sure all the equipment is turned off.**
- 2) **Connect the LINE OUT terminals of the Porta02 to the amplifier, using a pair of terminals on the amplifier such as AUX or VIDEO.**

NOTE

Do not use any terminals marked **PHONO** or intended for record decks. These are connected to a special circuit inside the amplifier which makes them unsuitable for anything except record decks.

- 3) **Connect your mastering recorder to a set of four TAPE terminals on the amplifier (two for REC and two for PLAY).**

You may be using an integrated system in which the mastering recorder and amplifier are built into one enclosure. In this case, you do not need to follow step 3.

You can listen to the Porta02 by selecting the amplifier’s input source to be from the terminals to which you connected the Porta02 (**AUX** or **VIDEO**, etc.).

When you have mixed down and you want to listen to the mixed tape, you should select the mastering recorder as the amplifier’s input source.

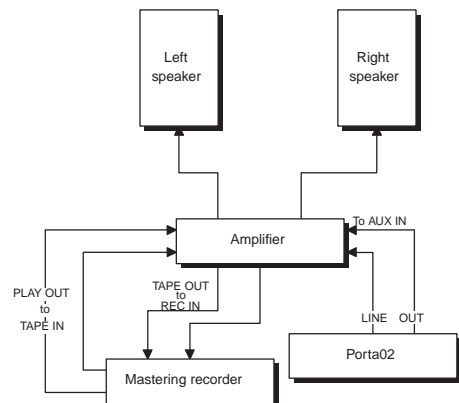

2 – Parts of the Porta02

This section gives an explanation of the different parts of the Porta02, and what

they do.

Parts of the Porta02

Parts of the Porta02

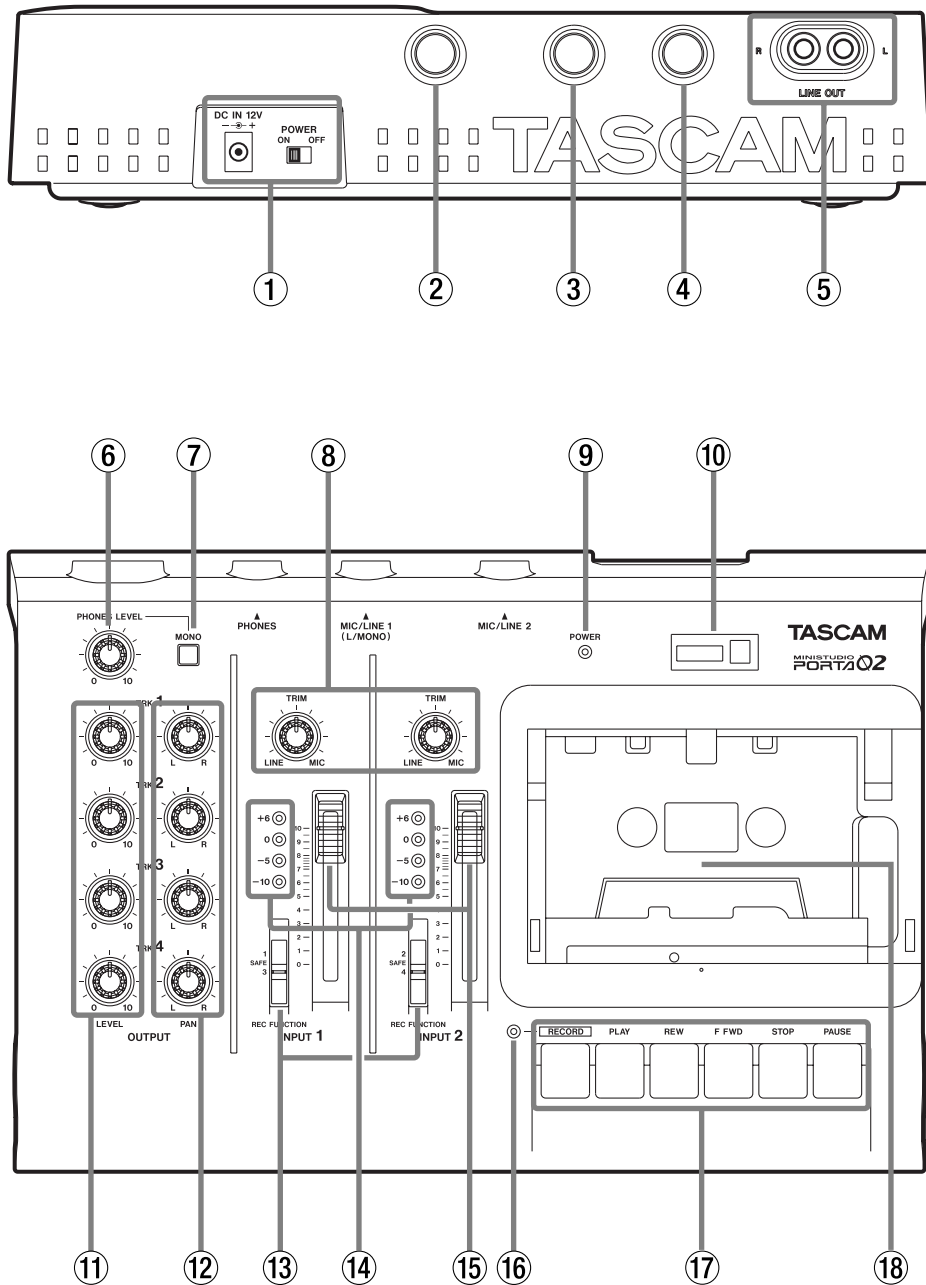

Parts of the Porta02

[1] POWER IN and switch

Use this jack to connect the PS-P2 AC adaptor which comes with your Porta02. When connecting the power, make sure the power switch is off (slide it to the right, as you look from the back).

WARNING

DO NOT use any adaptor with the Porta02 except the PS-P2 adaptor which comes with the Porta02.

Slide the switch to the left (looking from the back) to turn on the power to the Porta02.

[2] MIC/LINE 2

Use this 1/4" phone jack to connect the second channel audio source (instrument or microphone) to the Porta02.

WARNING

The Porta02 is designed to record signals from microphones, CD players, tape decks and musical instruments. It is not designed to record signals which come from the speaker outputs of any amplifier or equipment. If you try to plug such signals into the Porta02, you will almost certainly damage both the Porta02 and the other equipment.

[3] MIC/LINE 1 (MONO)

Use this 1/4" phone jack to connect the first channel audio source (instrument or microphone) to the Porta02.

If you connect an audio source to this jack, but do not connect a source to the **MIC/LINE 2** jack, the source at this **MIC/LINE 1** jack acts as a mono source, that is, it will be split between the first and second channels as if you had plugged the same source into both jacks.

[4] PHONES jack

This 1/4" jack allows you to connect a pair of stereo headphones to the Porta02.

WARNING

Do not use headphones equipped with a mono jack. This will cause damage to the Porta02's headphone amplifiers.

[5] LINE OUT

Use these RCA (pin or phono) jacks to connect your Porta02 to the amplifier or mastering recorder.

[6] PHONES LEVEL

This control adjusts the volume in headphones connected to the **PHONES** jack. Turn clockwise to increase the volume. There will be no output from the **PHONES** jack when the control is fully counter-clockwise. It has no effect on the level from the **LINE OUT** connectors.

[7] MONO switch

When this switch is pressed down (in), it changes the stereo signal from the **PHONES** jack into a mono signal (the same signal will be output from both the left and right channels). Press it again to return it to the "out" stereo position. It does not affect the signal from the **LINE OUT** connectors.

[8] TRIM (1 and 2)

Different pieces of equipment output signals at different levels. The **TRIM** controls allow you to match the Porta02 to these levels. A piece of equipment such as a CD player or cassette deck will output signals at a high (**LINE**) level, so the trim control should be turned fully counter-clockwise when such a device is being recorded. A microphone on the other hand, produces a lower signal level, and so the **TRIM** control should be turned fully

clockwise to **MIC** for any channel which is recording a microphone.

Instruments such as electric guitars produce a signal which is between **MIC** and **LINE** levels and the **TRIM** control should therefore be somewhere between fully clockwise and fully counter-clockwise. See 3.3, "Setting the level" for full details of how to adjust the **TRIM** controls for different input sources.

[9] POWER indicator

This yellow light is lit when the Porta02 is connected to the power supply and switched on.

[10] Tape counter and reset button

The tape counter allows you to note different parts of the tape and locate to them. Press the reset button to reset the counter to "000" at any time (we suggest that you only do this at the beginning of a recording).

[11] OUTPUT LEVEL controls

These controls change the levels of the four tape tracks in the **LINE OUT** and **PHONES** outputs. When one of these controls is turned fully counter-clockwise, the tape track corresponding to that control will not be heard in the **LINE OUT** and **PHONES** outputs.

[12] OUTPUT PAN controls

These controls change the position of the four tape tracks in the stereo **LINE OUT** and **PHONES** outputs. When one of these controls is turned fully counter-clockwise, the sound of the corresponding tape track will appear to come from the left, and when turned fully clockwise, it will appear to come from the right. When in the center position, the output will appear equally from both the left and right.

When the **PHONES MONO** switch is pressed, these controls will have no effect on the output from the **PHONES** jack.

[13] REC FUNCTION switches (1 and 2)

These switches control where the signals coming into the **MIC/LINE** jacks will be recorded. For both switches 1 and 2, the center position is marked as **SAFE**. When a switch is in this position, no signal will be recorded on tape. However, you can still listen to the signals coming into the **MIC/LINE** jacks and view the levels on the meters.

When set to a number (1 or 3 for channel 1, or 2 or 4 for channel 2), the signals input to the channel will be recorded on the track whose number has been set on the switch. This is called "assigning" or "routing" channels to tracks.

[14] Channel meters (1 and 2)

Each channel has a set of four LED indicators which show the level of the signals sent to the **LINE OUT L** and **R** jacks. Exactly what is metered depends on the **REC FUNCTION** switch settings, but generally, they display the signals at the **MIC/LINE IN** jacks, and when the input channels are set to **SAFE**, the meters show the off-tape signals, whose levels and pan positions are set using the **OUTPUT LEVEL** and **PAN** controls.

The best level for any input signal is when an averagely loud part of the signal lights the red **0** indicator, and the **+6** indicator (also red) is only lit by the loudest parts of the signal. See 3.3, "Setting the level" for details of how this should be set up.

[15] Channel faders (1 and 2)

These faders are used to adjust the level of the signals coming into the **MIC/LINE**

IN jacks. They should be used together with the **TRIM** controls (see 3.3, “Setting the level”) to adjust the levels of the signals routed to the tape tracks.

[16] **RECORD** indicator

This red indicator lights when the **RECORD** and **PLAY** keys are pressed, and at least one of the **REC FUNCTION** switches is not in the **SAFE** position.

Pressing **RECORD** and **PLAY** while both **REC FUNCTION** switches are set to **SAFE** has the same effect as pressing **PLAY**.

[17] **Transport controls**

These work in the same way as the controls on most cassette recorders. However, there are a few points you should note:

- Pressing the **RECORD** key will also press down the **PLAY** key.

- If the left record-protect tab of the cassette has been broken out, or if there is no cassette loaded, the **RECORD** key cannot be pressed.
- It is not possible to go directly from recording into playback mode.
- The **PAUSE** key only pauses playback and recording. It is not possible to pause the tape in fast forward and rewind modes.
- All keys lock down when pressed, except for the **STOP** key, and only work when locked down.

[18] **Cassette compartment cover**

The hinged cassette compartment cover is opened by lifting the tab on the right side.

There is no eject mechanism. You load and unload cassettes by hand, using a finger or fingers in the space to the right of the cassette.

3 – Making your first recording

This section describes how to make a 4-track recording using the Porta02. For this, we will assume that you are making a recording of your voice on two tracks (1 and 2), using a microphone, and recording a part of a stereo CD or cassette on the other two tracks (3 and 4). Make sure you know what you are going to say.

Start by making sure that you have all the equipment listed in 1.3, “What you need to make recordings”.

3.1 Setting up

- 1) **Make sure all equipment is turned off.**
- 2) **Connect the LINE OUT jacks of the Porta02 to the AUX IN jacks of the amplifier.**
- 3) **Connect the mastering recorder REC IN and PLAY OUT jacks to the appropriate jacks of the amplifier. See 1.4, “Connecting the Porta02” if you are not sure what you should be doing here.**
- 4) **With the INPUT 1 fader at the 0 position, plug the microphone into the MIC/LINE 1 jack. Do not plug anything into the MIC/LINE 2 jack.**
If the microphone has a switch, make sure this switch is off.
- 5) **Plug the stereo headphones into the PHONES jack of the Porta02.**
- 6) **Turn on the Porta02, the mastering recorder, and the amplifier (in that order).**
- 7) **Set the amplifier’s input source to AUX (or the name of the jacks to which the Porta02 is connected).**

3.2 Getting ready

- 1) **Clean the heads and pinch roller (see 1.2.4, “Cleaning the heads” and 1.2.5, “Cleaning the pinch roller”).**
- 2) **Insert a Type II (chrome) cassette.**
The tape should be towards the front of the Porta02, and the full spool should be on the left side. Put the non-tape part of the cassette in first, and then push the tape (front) down into place

3 Making your first recording

- 3) Play the tape for about 10 seconds and then stop the tape.
- 4) Press the counter reset button.

3.3 Setting the level

The aim of this section is to teach you to set the input level so that the average signals coming from the microphone will light the **0** meter indicator, and the loudest will light the **+6** indicator.

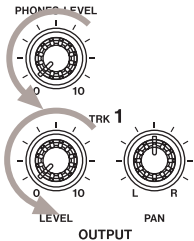

- 1) Make sure all **OUTPUT LEVEL** controls are set to **0**. Put on the headphones and set the **PHONES LEVEL** to the **0** position.

If you do not do turn down the speaker volume, you will probably get feedback (“howlround”) when you start using the microphone.

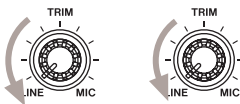

- 2) Set both **TRIM** controls to the **LINE** position.

Although you will probably end up with this control at the **MIC** position, or close to it, for now, set it to **LINE**.

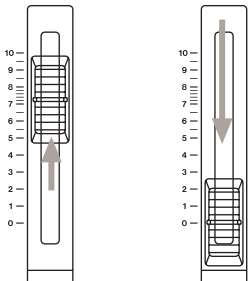

- 3) Take the **INPUT 2** fader to the **0** mark. Bring the **INPUT 1** fader up to between the **7** and **8** marks.

This is called the “nominal” position, and is the position where the electronics controlled by the fader will not have to amplify the signal too much (causing noise) or have too much signal going into them (causing distortion).

- 4) Switch the microphone on if necessary. Speak into the microphone at the volume you will be recording.

It is important than when you perform these level checks that you speak, sing or play at the level at which you will actually be recording. Most people, when they first start recording, tend to be a little louder than when they are simply checking the levels.

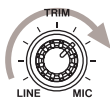

- 5) While talking into the microphone, turn the **INPUT 1 TRIM** control clockwise until the left **0** indicator is lit most of the time, and the **+6** indicator is lit on the loudest parts.

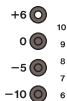

If the **0** indicator hardly lights at all, you may be too far from the microphone, or you are speaking too softly. If the microphone uses batteries, you may need to replace them.

You can also bring the fader up from the **7-8** position to increase the level, but you should do this only after the **TRIM** control has been turned fully clockwise.



- 6) Adjust the **PHONES LEVEL** until you are comfortable with what you hear in the headphones.

3.4 Recording the first track

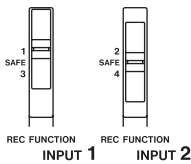

- 1) Set the REC FUNCTION switch of INPUT 1 to 1.

You are now ready to record on track 1. Make sure the REC FUNCTION switch of INPUT 2 is set to **SAFE**, so you don't record on it by accident.



- 2) Press the RECORD key (which will also press the PLAY key) and start recording the first spoken track.

If the level as shown by the meters now seems a little high, you can "back off" on the fader a little.



- 3) When you have finished (try to keep speaking for at least a minute), press the STOP key.



- 4) Rewind the tape to the 000 mark.



- 5) Start playing the tape, and adjust the LEVEL and PAN controls of track 1 so that you can hear clearly what you have just recorded.

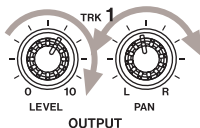

Note that meter 2 now shows the level of the tape replay on the right LINE OUT, rather than what is being input to the tape.

NOTE

You may notice a difference between the sound you hear when you replay the tape and the sound you hear when you are recording. This is perfectly normal, and is due to the way that the Porta02 lets you hear previously-recorded material.

- 6) Rewind and replay the tape again, listening carefully to your recording.
- 7) Rewind and re-record the track as many times as you think necessary.

Of course, this is only a test, so it doesn't matter too much, but when you're making a real recording, it's important to make the recording as good as possible.

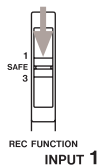

- 8) When you're happy with the recording, set the REC FUNCTION switch of INPUT 1 to SAFE.

If you replay now, both meters will now show off-tape monitoring

3 Making your first recording

3.5 Recording the next track

Since you plugged the microphone into **MIC/LINE 1 / MONO**, and didn't plug anything into **MIC/LINE 2**, the microphone signal is split as if it was plugged into both channels.

- 1) **Take fader 1 to the 0 mark.**
- 2) **Set the level for input channel 2 in the same way as you set it for input channel 1 (see 3.3, "Setting the level").**

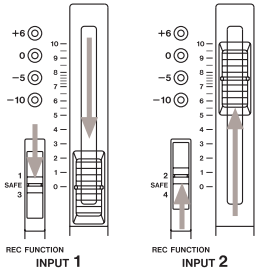

- 3) **Set REC FUNCTION switch for INPUT 2 to 2.**

You are now ready to record on track 2.

- 4) **Rehearse your second spoken part by playing back the first track (adjusting the level and pan if necessary) while speaking the words for the second track.**

- 5) **Rewind and record when you are ready.**

When you are recording, the meter of **INPUT 2** will show the input levels of input 2. Since the signal is now going to track 2, the meter for input 1 will not show anything.

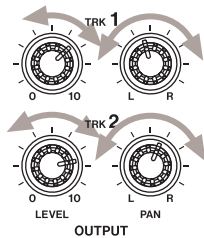

- 6) **Rewind and playback when you have recorded. Adjust the level and pan position of the two tracks with the LEVEL and PAN controls for tracks 1 and 2.**

Remember that the fader adjusts the level of what goes onto tape, not the replay levels.

When you are playing back, the meter of **INPUT 1** will show the level of the signal from the left outputs, and the meter of **INPUT 2** will show the input signal level as long as the **REC FUNCTION** switch is not **SAFE**.

- 7) **Rewind and repeat the recording of track 2 until you are satisfied with it.**

SAFE input channel 2, and take both faders down to 0. Set the TRIM controls of both inputs to LINE.

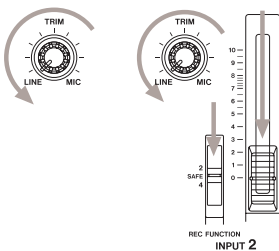

3.6 Recording the stereo backing

Now that tracks 1 and 2 are filled with spoken words, we'll put some backing music behind them. We'll assume that you're using a CD player here (of course, it may be an MD player or a cassette player).

NOTE

This is a test recording and will not be used except as a test. However, if you are making recordings for public performance or distribution which include pre-recorded copyright material, you should be aware of the regulations concerning copyright in the area where you live. Unauthorized recording of copyright material may be illegal.

- 1) **Make sure the volume on the amplifier is turned all the way down (it should already be turned down).**
- 2) **Take off the headphones and unplug the microphone.**
- 3) **Connect the left and right LINE OUT of the CD player to MIC/LINE inputs 1 and 2 of the Porta03.**
- 4) **Set the REC FUNCTION switches of INPUTs 1 and 2 to 3 and 4.**

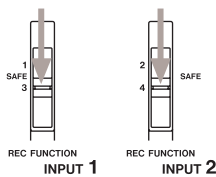

You are now ready to start recording on tracks 3 and 4.

- 5) **Start playing the CD track you will be recording. Adjust the faders so that the +6 meter indicators light on the loudest parts of the CD.**

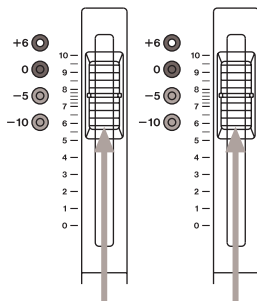

- 6) **Slowly turn up the amplifier volume so that you are listening at a comfortable level.**
- 7) **Make the CD ready to play, and make sure that the Porta02 is rewound to the start of the recording.**
- 8) **Start recording, and start replaying the CD.**
- 9) **When you come to the end of the CD material, stop the CD and Porta02, and rewind the Porta02 tape to the beginning of the recording.**

3 Making your first recording

3.7 Mixdown

Make sure that your mastering recorder is connected to the monitoring system.

- 1) **Set both REC FUNCTION switches to SAFE, and move both faders down to 0.**

This will stop any extra unwanted noise from the inputs appearing in the final mix.

- 2) **Make sure the mastering recorder is ready to record, and put it into record pause mode. Do not start recording yet.**

If you are using a tape for mastering, make sure that you are not recording over anything you want to keep. If you are using a new tape, make sure that you have taken the tape past the leader portion. Make the noise reduction, etc. settings on the mastering recorder, which will give you the best sound quality.

- 3) **Play back the recording on the Porta02 and adjust the OUTPUT LEVEL and PAN controls on the Porta02.**

The nominal position (the best position) for the **LEVEL** controls is about the 2 to 3 o'clock position. This is the position you should regard as normal.

It is usual to put the **PAN** controls for a stereo source such as a CD fully right and fully left. You can place the two voices anywhere in the stereo picture.

Practice adjusting the levels of tracks 3 and 4 together to fade the backing music in and out.

- 4) **While adjusting the levels on the Porta02, watch the recording levels on the mastering recorder. If they are too high, take down the recording level on the mastering recorder.**

Remember that if you are recording on a digital recorder, such as an MD recorder, if the signal levels are too high, the result will be extremely unpleasant distortion. Analog recorders, such as cassette decks, will also distort if the levels are too high, but the distortion is much more pleasant (even so, you should try to avoid distortion in the mixdown).

- 5) **When you are happy with the mix rehearsal, rewind to the start of the recording on the Porta02.**

- 6) **Start recording on the mastering machine, and start playback on the Porta02.**

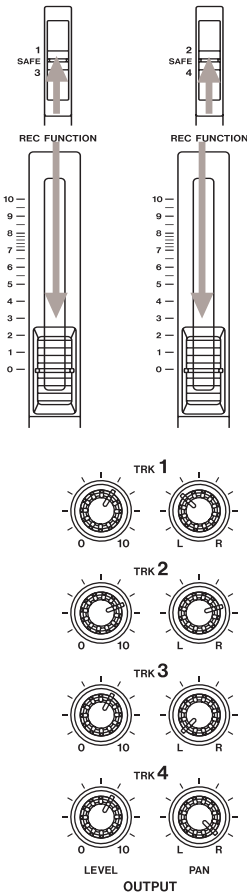

- 7) **Mix the tracks, fading the backing music on tracks 3 and 4 to taste.**
- 8) **At the end, stop both machines. Rewind the mastering recorder.**
- 9) **Set the amplifier input source to the mastering recorder, and replay your mix.**
- 10) **If you are not happy with the mix, you can do it again, either recording over the old mix, or adding the new mix after the old one.**

Congratulations! You have now completed your first recording project with the Porta02. Rewind the Porta02 tape to the start, remove it, and clean the Porta02's heads.

4 – Hints and advanced tips

This section gives a few hints and tips which may be useful to you when you make recordings using the Porta02.

4.1 Recording techniques

Learning how to record is an art, not a science. One of the best teachers is experience. However, there are a few things mentioned here which may be useful to

you, and there are several good books on the subject which can explain the theory of recording and some of the techniques.

4.1.1 Recording electric guitars

Much of the sound of an electric guitar (and also bass) is due to the effects, amplifier and speakers, as well as the guitar and style of playing. If you plug the guitar straight into the Porta02, you will, of course, be able to record it, but the sound will probably not be what you are used to.

Plugging effects units between the guitar and the Porta02 will certainly help to produce a fuller sound. The sound which will come closest to a live sound, though, will be provided by the amplifier itself.

You can adopt one of two approaches: either to put a microphone in front of the guitar speaker and record this (at **MIC** level), or to connect the output of the pre-amplifier to the Porta02 and record at **LINE** level.

4.1.2 Recording with effects

Professional recordings often use effects like digital reverberation on vocals, etc. You can add some of these effects by plugging the microphone into an effects unit, and plugging the unit into the Porta02. Note that the effects unit must be able to accept microphone-level signals, and will output to the Porta02 at **LINE** levels.

In addition, you will need to use the internal balance control in the unit to decide how much of the “dry” (un-effected) sound will be passed through to the Porta02 for recording.

If you do not have access to a reverberation unit, you can try recording vocals in a very “live” room (without much furniture).

WARNING

Do not connect the speaker output (or headphone output, if provided) of the amplifier to the Porta02. This will almost certainly damage the Porta02, and may damage the amplifier. Only use outputs which are marked **LINE OUT, PRE OUT, DIRECT OUT** and so on. Avoid using any outputs marked **SPEAKER OUT, SP OUT, 4Ω, 8Ω, 16Ω** or the like.

4.1.3 Metering

In general, you should not try to record at too high a level, and the **+6** indicator should not be lit more than half the time (at the very most).

The meters display the input levels to the channels at all times except when playing back with the input channels in **SAFE** mode.

When playing back if one or both of the input channels has set to **SAFE**, they will display the levels of the signal sent to the left **LINE OUT** (channel and meter 1) or the right **LINE OUT** (channel and meter 2). If a signal is also received at the **MIC/LINE** input jacks, this will be added to the playback for metering.

4.1.4 When you're not recording

Try to get into the habit of always leaving the **REC FUNCTION** switches in the **SAFE** position unless you are actually recording or rehearsing a take. This will stop you

recording by accident (remember that pressing **RECORD** with both channels **SAFE** is the same as pressing **PLAY**).

4.2 Mixdown

What sounds good is something that depends on personal taste, but most professionals try to avoid mixes with too much bass or high end (unless it's for a special effect). However, the most impor-

tant pieces of equipment that you have are your ears! Train yourself to use them so that you can spot mistakes quickly, and you know how to put them right, just by listening. It's a useful skill!

4.2.1 Recording more than four tracks (i)

Although the Porta02 has only 4 tracks, it is possible to produce a mix with more than four sounds. Here's one way, which involves adding one or two more extra inputs to the four recorded tape tracks.

These extra inputs will be panned either fully left or right (or one track will be in the center) and the mix proceeds as the extra inputs are recorded. This method is therefore useful for adding a pre-recorded stereo backing to go behind the four recorded tracks.

1) **Record on all four tracks of the Porta02.**

2) **Set both REC FUNCTION switches to SAFE.**

3) **Connect the source for the extra inputs to the MIC/LINE jacks and adjust the TRIM controls to match the level.**

4) **Play back the tape, and use the OUTPUT LEVEL and PAN controls to adjust the playback of the tape tracks.**

5) **Use the faders to adjust the levels of the input signals against the tape tracks.**

4.2.2 Recording more than 4 tracks (ii)

For this method, there must be an ordinary stereo cassette recorder used as the mastering recorder.

The four tracks of the Porta02 are mixed in the usual way onto a stereo cassette. This cassette is then removed from the mastering recorder and replaces the 4-

5 Troubleshooting

track tape in the Porta02. The left and right stereo tracks of the mastering recorder can be used as tracks 1 and 2 of the Porta02, leaving tracks 3 and 4 ready for recording.

There are a few points to remember:

- Although you can repeat this process of mixing 4 tracks to 2 and then adding 2 more, as you repeat the mix process, noise and hiss will build up to a point where the quality becomes unacceptable.
- The mastering recorder must have its noise reduction turned **off** when mix-

ing the Porta02 tracks to the mastering machine, as the Porta02 does not use noise reduction. Of course, on the final stereo mix, you can use noise reduction on the mastering machine.

- Once you have mixed the four tracks to two, you cannot adjust their levels or pan positions again on the new tape. Think ahead to what tracks you will record on the new tape, and mix accordingly.
- When using this technique, always use the same type of tape in the Porta02 and mastering machine. Differences in tape type may affect the sound.

5 – Troubleshooting

Tracing faults in a recording setup is often a mixture of logical deduction and patience. Very often, the problem is caused by something simple; a cable

which hasn't been plugged in properly, or a faulty cable. If you discover a faulty cable, replace it with a new one—it's not worth hanging onto bad cables!

The Porta02's POWER light does not come on	Is the PS-P2 adaptor plugged into the power supply? Is the PS-P2 adaptor plugged into the Porta02? Is the switch on the Porta02 set to ON?
The tape does not move when PLAY is pressed	Is the tape properly inserted in the Porta02? Is the tape at the end of the tape?
Some tracks have been recorded on the tape, but nothing can be heard when playing back	If you've just put in a tape you recorded in another session, make sure that it's the right way round. Make sure the OUTPUT LEVEL controls are set to monitor the tape tracks (not at 0). Set the REC FUNCTION switches to SAFE and look at the meters. Try monitoring through headphones and adjust the PHONES LEVEL . If you can hear something through the headphones, check the LINE OUT connections. Make sure the amplifier is set to the correct input source.
Nothing appears on the meter indicators when a source is played	Is the source (microphone, guitar, etc.) switched on and volume control turned up? If it uses batteries, does it need new batteries? Is the TRIM control of the channel set correctly?
Cannot press the RECORD key	Is the tape properly inserted in the Porta02? Is the tape record-protected?
The RECORD key is pressed, the tape moves, but nothing is recorded, or the level is very low	Is the REC FUNCTION set to SAFE ? Check the OUTPUT LEVEL control for the track. Is the TRIM level set correctly (a microphone feeding a channel set to LINE will sound very faint).

The PAN controls don't work	<p>If you're listening through headphones, is the Porta02's MONO switch pressed?</p> <p>If you're listening through speakers, is there a MONO switch on the amplifier which has been pressed?</p>
Recorded sound is distorted when recording	<p>When monitoring while recording, the sound will often be a little different to when it is played back. A large amount of distortion may be caused by recording at too high a level (shown by the meter +6 indicator being lit all or most of the time). Adjust the TRIM level and/or back off on the faders.</p> <p>If the meter +6 indicator is not constantly lit, you may want to reduce the headphone level; you may be driving the headphones too hard.</p>
Recorded sound distorts on playback.	<p>Either the sound was recorded at too high a level, or the summed level of all four tracks is too high. Try reducing the level of all tracks so that the meter +6 indicator is not constantly lit on playback (set REC FUNCTION to SAFE). If one track only is distorted, it was recorded at too high a level.</p>
Tape sounds muffled on playback	<p>The heads are dirty. Clean them (see 1.2.4, "Cleaning the heads")</p>
Pitch changes (wow and flutter)	<p>The capstan and pinch roller are dirty. Clean the capstan and pinch roller (see 1.2.5, "Cleaning the pinch roller").</p>
A stereo tape recorded on another machine sounds really strange!	<p>You're probably listening to tracks 1 and 2 forwards at the same time as 3 and 4 backwards. Turn down the OUTPUT LEVEL controls of tracks 3 and 4.</p> <p>If the sound is unnaturally "bright", it's quite likely that the tape was recorded on the other machine using noise reduction.</p>

6 – Specifications

Recommended tape type	Compact cassette tape, CrO ₂ (Type II, 70µs EQ), C-30 to C-90
Track format	4 tracks, 4 channels
Head configuration	1 x 4-track record/replay head (Permaloy) 1 x 4-track erase head (ferrite)
Motor type	1 x DC motor (capstan and reel motor)
Tape speed	1 7/8 in./sec (4.76 cm/sec)
Wow and flutter	0.18%
Fast wind speed	Approx 120 seconds (C-60 tape)
Power requirements	USA/CANADA: 120V AC, 60Hz U.K./EUROPE: 230V AC, 50Hz AUSTRALIA: 240V AC, 50Hz
Power consumption	7W, via the supplied PS-P2 AC adaptor
Physical dimensions (w x h x d)	305 x 64 x 205 (mm), 12.0 x 2.5 x 8.1 (in.), maximum height (including controls) 80 (mm), 3.1(in)
Weight (main unit)	1.5kg (3.3lb)
MIC/LINE inputs (2 x 1/4" jacks)	
Input level	-50dBV, TRIM at maximum; -10dBV, TRIM at minimum
Input impedance	50kΩ

6 Specifications

LINE outputs (2 x RCA jacks)

Output level -10dBV

Output impedance 10k Ω

Headphone output (1/4" stereo jack)

Output level 60mW + 60mW

Output impedance 30 Ω

Frequency response 50Hz – 12.5kHz \pm 3dB

Signal-to-noise ratio 43dB

Total Harmonic Distortion Better than 3.0% (400Hz, -10dB)

Channel separation Better than 40dB (at 1kHz)

Erasure 65dB (at 1kHz)

0 dBV is referenced to 1 volt

Changes in features or specifications may be made without notice or obligation.

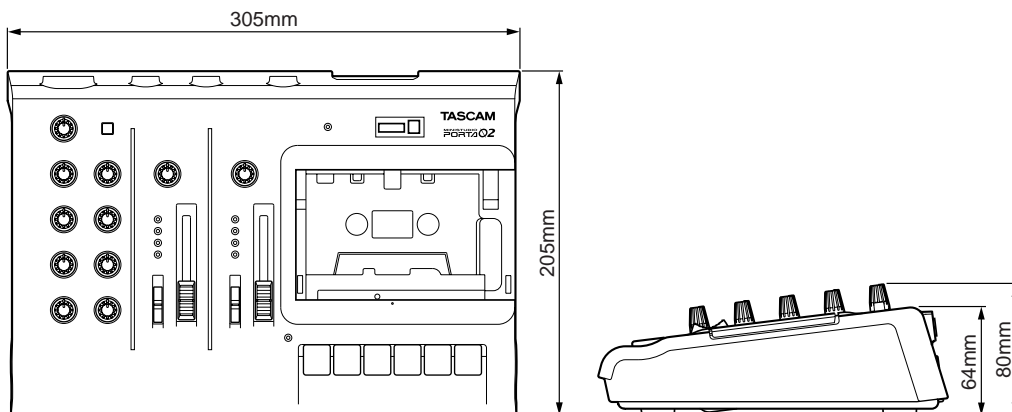

TEAC CORPORATION

3-7-3, Nakacho, Musashino-shi, Tokyo 180, Japan Phone: (0422) 52-5082

TEAC AMERICA, INC. 7733 Telegraph Road, Montebello, California 90640 Phone: (213) 726-0303

TEAC CANADA LTD. 5939 Wallace Street, Mississauga, Ontario L4Z 1Z8, Canada Phone: 905-890-8008 Facsimile: 905-890-9888

TEAC MEXICO, S.A. De C.V. Privada De Corina, No.18, Colonia Del Carmen Coyoacan, Mexico DF 04100 Phone: 5-658-1943

TEAC UK LIMITED 5 Marlin House, Marlins Meadow, The Croxley Centre, Watford, Herts. WD1 8YA, U.K. Phone: 01923-819699

TEAC DEUTSCHLAND GmbH Bahnstrasse 12, 65205 Wiesbaden-Erbenheim, Germany Phone: 0611-71580

TEAC FRANCE S.A. 17 Rue Alexis-de-Tocqueville, CE 005 92182 Antony Cedex, France Phone: (01) 42.37.01.02

TEAC BELGIUM NV/SA P.A. TEAC Nederland BV, Perkinsbaan 11a, 3439 ND Nieuwegein, Netherlands Phone: 0031-30-6048115

TEAC NEDERLAND BV Perkinsbaan 11a, 3439 ND Nieuwegein, Netherlands Phone: 030-6030229

TEAC AUSTRALIA PTY., LTD. 106 Bay Street, Port Melbourne, Victoria 3207, Australia Phone: (03) 9644-2442
A.C.N. 005 408 462

TEAC ITALIANA S.p.A. Via C. Cantù 5, 20092 Cinisello Balsamo, Milano, Italy Phone: 02-6601050

Free Manuals Download Website

<http://myh66.com>

<http://usermanuals.us>

<http://www.somanuals.com>

<http://www.4manuals.cc>

<http://www.manual-lib.com>

<http://www.404manual.com>

<http://www.luxmanual.com>

<http://aubethermostatmanual.com>

Golf course search by state

<http://golfingnear.com>

Email search by domain

<http://emailbydomain.com>

Auto manuals search

<http://auto.somanuals.com>

TV manuals search

<http://tv.somanuals.com>