

TASCAM

D01252220A

DR-680MKII

Portable Multitrack Recorder

OWNER'S MANUAL

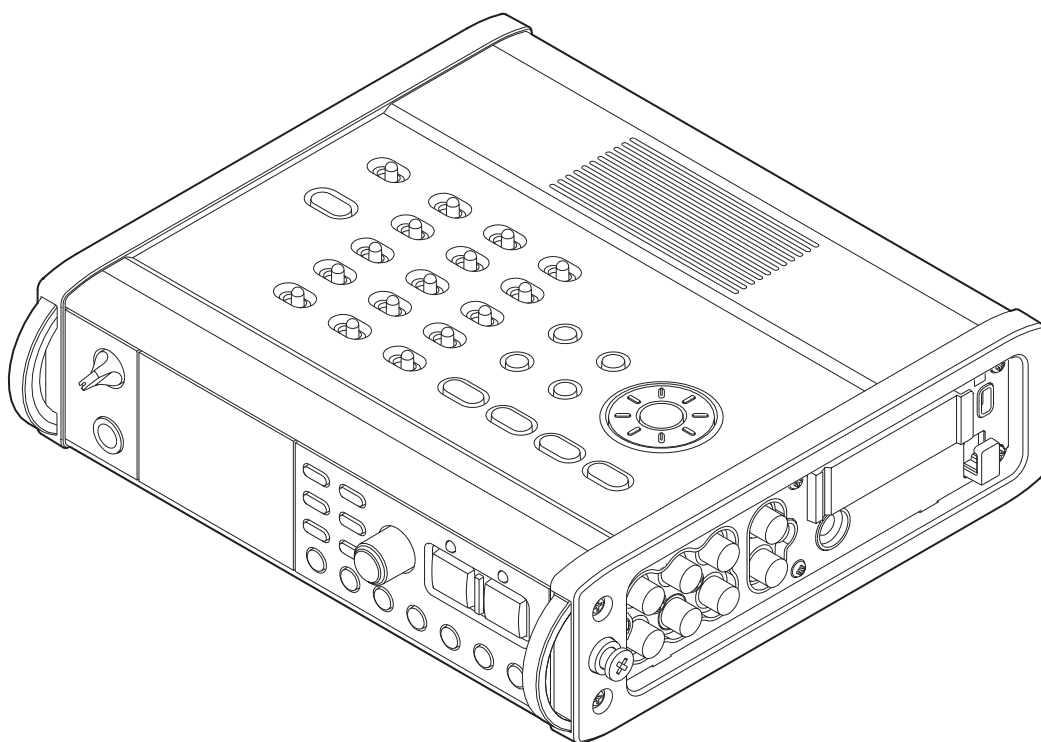

IMPORTANT SAFETY PRECAUTIONS



CAUTION
RISK OF ELECTRIC SHOCK
DO NOT OPEN



CAUTION: TO REDUCE THE RISK OF ELECTRIC SHOCK, DO NOT REMOVE COVER (OR BACK). NO USER-SERVICEABLE PARTS INSIDE. REFER SERVICING TO QUALIFIED SERVICE PERSONNEL.



The lightning flash with arrowhead symbol, within equilateral triangle, is intended to alert the user to the presence of uninsulated "dangerous voltage" within the product's enclosure that may be of sufficient magnitude to constitute a risk of electric shock to persons.



The exclamation point within an equilateral triangle is intended to alert the user to the presence of important operating and maintenance (servicing) instructions in the literature accompanying the appliance.

For U.S.A.

TO THE USER

This equipment has been tested and found to comply with the limits for a Class B digital device, pursuant to Part 15 of the FCC Rules. These limits are designed to provide reasonable protection against harmful interference in a residential installation. This equipment generates, uses, and can radiate radio frequency energy and, if not installed and used in accordance with the instruction manual, may cause harmful interference to radio communications.

However, there is no guarantee that interference will not occur in a particular installation. If this equipment does cause harmful interference to radio or television reception, which can be determined by turning the equipment off and on, the user is encouraged to try to correct the interference by one or more of the following measures.

- Reorient or relocate the receiving antenna.
- Increase the separation between the equipment and receiver.
- Connect the equipment into an outlet on a circuit different from that to which the receiver is connected.
- Consult the dealer or an experienced radio/TV technician for help.

CAUTION:

Changes or modifications to this equipment not expressly approved by TEAC CORPORATION for compliance could void the user's authority to operate this equipment.

WARNING: TO PREVENT FIRE OR SHOCK HAZARD, DO NOT EXPOSE THIS APPLIANCE TO RAIN OR MOISTURE.

Declaration of Conformity

Responsible party: TEAC AMERICA, INC.

Address: 1834 Gage Road, Montebello, California, U.S.A.

Telephone number: 1-323-726-0303

This device complies with Part 15 of the FCC Rules. Operation is subject to the following two conditions: (1) this device may not cause harmful interference, and (2) this device must accept any interference received, including interference that may cause undesired operation.



DECLARATION OF CONFORMITY

We, TEAC EUROPE GmbH, Bahnstrasse 12, 65205 Wiesbaden-Erbenheim, Germany declare in own responsibility, the TEAC product described in this manual is in compliance with the corresponding technical standards.



For Canada

THIS CLASS B DIGITAL APPARATUS COMPLIES WITH CANADIAN ICES-003.

CET APPAREIL NUMERIQUE DE LA CLASSE B EST CONFORME A LA NORME NMB-003 DU CANADA.

IMPORTANT SAFETY INSTRUCTIONS

- 1 Read these instructions.
 - 2 Keep these instructions.
 - 3 Heed all warnings.
 - 4 Follow all instructions.
 - 5 Do not use this apparatus near water.
 - 6 Clean only with dry cloth.
 - 7 Do not block any ventilation openings. Install in accordance with the manufacturer's instructions.
 - 8 Do not install near any heat sources such as radiators, heat registers, stoves, or other apparatus (including amplifiers) that produce heat.
 - 9 Do not defeat the safety purpose of the polarized or grounding-type plug. A polarized plug has two blades with one wider than the other. A grounding type plug has two blades and a third grounding prong. The wide blade or the third prong are provided for your safety. If the provided plug does not fit into your outlet, consult an electrician for replacement of the obsolete outlet.
 - 10 Protect the power cord from being walked on or pinched particularly at plugs, convenience receptacles, and the point where they exit from the apparatus.
 - 11 Only use attachments/accessories specified by the manufacturer.
 - 12 Use only with the cart, stand, tripod, bracket, or table specified by the manufacturer, or sold with the apparatus. When a cart is used, use caution when moving the cart/apparatus combination to avoid injury from tip-over.
- The apparatus draws nominal non-operating power from the AC outlet with its POWER or STANDBY/ON switch not in the ON position.
 - The mains plug is used as the disconnect device, the disconnect device shall remain readily operable.
 - Caution should be taken when using earphones or headphones with the product because excessive sound pressure (volume) from earphones or headphones can cause hearing loss.
 - If you are experiencing problems with this product, contact TEAC for a service referral. Do not use the product until it has been repaired.

CAUTION

- Do not expose this apparatus to drips or splashes.
- Do not place any objects filled with liquids, such as vases, on the apparatus.
- Do not install this apparatus in a confined space such as a book case or similar unit.
- The apparatus should be located close enough to the AC outlet so that you can easily grasp the power cord plug at any time.
- If the product uses batteries (including a battery pack or installed batteries), they should not be exposed to sunshine, fire or excessive heat.
- CAUTION for products that use replaceable lithium batteries: there is danger of explosion if a battery is replaced with an incorrect type of battery. Replace only with the same or equivalent type.

WARNING

- Products with Class I construction are equipped with a power supply cord that has a grounding plug. The cord of such a product must be plugged into an AC outlet that has a protective grounding connection.



- 13 Unplug this apparatus during lightning storms or when unused for long periods of time.
- 14 Refer all servicing to qualified service personnel. Servicing is required when the apparatus has been damaged in any way, such as power-supply cord or plug is damaged, liquid has been spilled or objects have fallen into the apparatus, the apparatus has been exposed to rain or moisture, does not operate normally, or has been dropped.

IMPORTANT SAFETY INSTRUCTIONS

CAUTIONS ABOUT BATTERIES

This product uses batteries. Misuse of batteries could cause a leak, rupture or other trouble. Always abide by the following precautions when using batteries.

- Never recharge non-rechargeable batteries. The batteries could rupture or leak, causing fire or injury.
- When installing batteries, pay attention to the polarity indications (plus/minus (\oplus / \ominus) orientation), and install them correctly in the battery compartment as indicated. Putting them in backward could make the batteries rupture or leak, causing fire, injury or stains around them.
- When you store or dispose batteries, isolate their terminals with insulation tape or something like that to prevent them from contacting other batteries or metallic objects.
- When throwing used batteries away, follow the disposal instructions indicated on the batteries and the local disposal laws.
- Do not use batteries other than those specified. Do not mix and use new and old batteries or different types of batteries together. The batteries could rupture or leak, causing fire, injury or stains around them.
- Do not carry or store batteries together with small metal objects. The batteries could short, causing leak, rupture or other trouble.
- Do not heat or disassemble batteries. Do not put them in fire or water. Batteries could rupture or leak, causing fire, injury or stains around them.
- If the battery fluid leaks, wipe away any fluid on the battery case before inserting new batteries. If the battery fluid gets in an eye, it could cause loss of eyesight. If fluid does enter an eye, wash it out thoroughly with clean water without rubbing the eye and then consult a doctor immediately. If the fluid gets on a person's body or clothing, it could cause skin injuries or burns. If this should happen, wash it off with clean water and then consult a doctor immediately.
- The unit power should be off when you install and replace batteries.
- Remove the batteries if you do not plan to use the unit for a long time. Batteries could rupture or leak, causing fire, injury or stains around them. If the battery fluid leaks, wipe away any fluid on the battery compartment before inserting new batteries.
- Do not disassemble a battery. The acid inside the battery could harm skin or clothing.

■ For European Customers

Disposal of electrical and electronic equipment

- (a) All electrical and electronic equipment should be disposed of separately from the municipal waste stream via designated collection facilities appointed by the government or the local authorities.
- (b) By disposing of the electrical and electronic equipment correctly, you will help save valuable resources and prevent any potential negative effects on human health and the environment.
- (c) Improper disposal of waste equipment can have serious effects on the environment and human health as a result of the presence of hazardous substances in electrical and electronic equipment.
- (d) The crossed out wheeled dust bin symbol indicates that electrical and electronic equipment must be collected and disposed of separately from household waste. 
- (e) The return and collection systems are available to the end users. For more detailed information about disposal of old electrical and electronic equipment, please contact your city office, waste disposal service or the shop where you purchased the equipment.

Disposal of batteries and/or accumulators

- (a) Waste batteries and/or accumulators should be disposed of separately from the municipal waste stream via designated collection facilities appointed by the government or the local authorities.
- (b) By disposing of waste batteries and/or accumulators correctly, you will help save valuable resources and prevent any potential negative effects on human health and the environment.
- (c) Improper disposal of waste batteries and/or accumulators can have serious effects on the environment and human health as a result of the presence of hazardous substances in batteries and/or accumulators.
- (d) The crossed out wheeled dust bin symbol indicates that batteries and/or accumulators must be collected and disposed of separately from household waste. 
Pb, Hg, Cd
If the battery or accumulator contains more than the specified values of lead (Pb), mercury (Hg), and/or cadmium (Cd) defined in the Battery Directive (2006/66/EC), then the chemical symbols for lead (Pb), mercury (Hg) and/or cadmium (Cd) will be indicated beneath the crossed out wheeled dust bin symbol.
- (e) The return and collection systems are available to the end users. For more detailed information about disposal of waste batteries and/or accumulators, please contact your city office, waste disposal service or the shop where you purchased them.

1 – Introduction 7

Features	7
Items included with the product	7
Conventions used in this manual.....	7
Intellectual property rights	8
About SD cards	8
Precautions for use.....	8
Precautions for placement and use.....	9
Beware of condensation.....	9
Cleaning the unit.....	9
User registration.....	9

2 – Names and Functions of Parts 10

Top panel	10
Front panel	11
Left side panel	12
Right side panel	13
Bottom panel	14
Home Screen	15
Menu structure	16
Using menus.....	17
Operation basics	18
Functions Screen.....	18
Repeat activation	18
Pre-record activation	18
Auto-record activation.....	18
DIN/MIX monitor settings.....	19
Limiter activation	19
Low-cut filter activation	19

3 – Preparations 20

Powering the unit	20
About the power supply	20
Using AA batteries.....	20
Using the AC adaptor.....	20
Changing the outlet plug.....	21
Turning the power on and putting the unit into standby.....	21
Turning the power on.....	21
Putting the unit into standby	21
Inserting and removing SD cards.....	21
Inserting an SD card	21
Ejecting an SD card.....	22
Preparing an SD card for use	22
Card write-protection.....	22
Setting the date and time.....	22

Turning the built-in speaker output on and off.....	23
Connecting monitoring equipment	23
Adjusting the display contrast	23

4 – Recording 24

Files and takes	24
Recording settings.....	24
Setting the recording file format.....	24
Setting the sampling frequency	25
Setting the file recording mode	25
Stereo track recording settings.....	25
Arming and disarming tracks for recording	25
Creation of new takes when restarting recording.....	26
Setting the name given to recording takes.....	26
Editing the user take names.....	27
Resetting take name numbering	27
Available recording time display	27
Set the folder for saving takes.....	27
Connecting other equipment	28
Input settings	28
Setting the input sources.....	28
Phantom power	28
Selecting the inputs for recording to tracks 5 and 6	29
Adjusting the input levels.....	29
Recording a take.....	30
Recording a stereo mix.....	31
Simultaneously recording two files at different input levels (DUAL REC).....	31
Enabling dual recording	31
Starting dual recording.....	32
Dual recording take names	32
Using the solo function	32
Automatically starting and pausing recording (auto-record function).....	32
Using the auto-record function	32
Auto-record settings.....	32
Automatically cutting unnecessary silences when recording (silent cut function)	33
Automatically adding marks at the position where recording restarts	33
Track incrementation.....	34

Contents

Manually incrementing tracks during recording.....	34
Automatically incrementing tracks by file size.....	34
Using the limiter.....	34
Using the low-cut filter.....	35
Turning the low-cut filter on and off.....	35
Setting the cut-off frequency of the low-cut filter.....	35
Using marks.....	35
Manually adding marks when recording and during playback.....	35
Moving to a mark.....	35
Erasing marks.....	36
Pre-recording.....	36
Recording times.....	37
5 – Take and folder operations (BROWSE screen).....	38
Navigating the BROWSE screen.....	38
Icons on the BROWSE screen.....	38
Take operations.....	38
Folder operations.....	39
6 – Playback.....	40
Playback.....	40
Starting playback.....	40
Stopping playback.....	40
Pausing playback.....	40
Searching forward and backward.....	40
Selecting a take for playback.....	40
Changing the playback position (scrubbing).....	40
Mixing and outputting a multitrack recording.....	41
Using the internal mixer.....	41
Using the solo function.....	41
Playing a stereo track.....	41
Setting the playback area.....	42
Selecting a folder for the playback area on the BROWSE screen.....	42
Setting the search speed.....	42
Repeat playback.....	42
7 – Connection with a computer.....	43
Copying files to a computer.....	43
Copying files from a computer.....	44
Ending the connection with a computer.....	44
8 – Cascade function.....	45
Preparing to use the cascade function.....	45
Cascade recording.....	45
Cascade playback.....	45
Disabling cascade operation.....	45
Precautions for use of the cascade function..	46
9 – Other Settings and Information Display.....	47
Using mid-side mic decoding.....	47
Connecting a mid-side microphone.....	47
Setting the MS decoding mode.....	47
Recording with mid-side decoding.....	47
GANG function.....	48
Output settings.....	48
Analog output settings.....	48
Digital output settings.....	49
System settings.....	49
Power AUTO OFF settings.....	49
Turning the backlight off automatically ...	49
Cascade settings.....	50
Setting the extent of the panel operation lock function.....	50
Setting the battery type.....	50
Initializing the unit.....	50
Viewing system information.....	50
Reformatting SD cards.....	51
Viewing SD card information.....	51
10 – Messages.....	52
11 – Troubleshooting.....	54
12 – Specifications.....	55
Recording media and formats.....	55
Input and output.....	55
Analog audio input and output.....	55
Digital audio input and output.....	56
Control input and output.....	56
Audio performance.....	56
Other specifications.....	56
Dimensions.....	57
Block diagrams.....	58

1 – Introduction

Thank you very much for purchasing a TASCAM DR-680MKII Portable Multitrack Recorder. Please read this manual thoroughly before using the unit so that you understand correct operating procedures and can use its functions fully. We hope that you enjoy using this unit for many years.

Please keep this manual so that you can read it at any time. A digital copy of this manual can also be downloaded from the TEAC Global Site (<http://teac-global.com/>).

Features

- 8-track recording with a resolution of up to 24-bit, 96 kHz (6 analog inputs with stereo mix, or 6 analog inputs with digital stereo input)
- 2-track recording resolution of up to 24-bit, 192 kHz
- Recording/playback media: SD/SDHC/SDXC cards (up to 128 GB)
- Recording/playback formats: BWF, WAV, MP3
- Recording up to 4 tracks in MP3 format simultaneously possible
- Sampling frequencies: 44.1 k, 48 k, 96 k and 192 kHz
- Quantization rates: 16-bit, 24-bit
- MP3 files can be recorded at resolutions of 96/128/192/320 kbps
- 6 balanced mic/line inputs (1–4 are XLR/TRS combo jacks and 5–6 are TRS jacks)
- Mic inputs can provide +48V phantom power
- Limiters on each input can automatically adjust their levels appropriately if input levels are too high
- Low-cut filters on each input are useful for reducing low-frequency noise
- 6 unbalanced line outputs (RCA pin jacks)
- S/PDIF and AES/EBU digital input and output (coaxial)
- Supports MS mic decoding
- Cascade function allows the transport of multiple DR-680MKII units to be controlled by a single master unit
- Pre-record function allows up to 2 seconds of input before the start of recording to be captured
- Auto-record function allows the unit to start recording automatically when it detects a set sound input level
- Mark function allows movement to specific playback positions
- Button lock function can be used to prevent misoperation
- Repeat playback function
- Mixer for monitoring with level and pan controls
- User can start a new take at any time without interrupting recording
- Take names can be based on a word set by the user or the date
- 500-mW monaural output speaker built-in
- 50-mW + 50-mW headphones output
- Operates on power from 8 AA batteries or an AC adaptor (GPE248-120200-Z)

- LCD with 128 x 64 pixel resolution and a backlight
- USB2.0 port
- USB cable included

Items included with the product

The DR-680MKII package contains the following items. Take care when opening the package not to damage the items. Keep the package materials for transportation in the future.

Please contact the store where you purchased this unit if any of these items are missing or have been damaged during transportation.

- Main unit.....×1
- AC adaptor (GPE248-120200-Z).....×1
- USB cable×1
- Shoulder strap.....×1
- Owner's manual (this document)×1

The warranty is included at the end of English manual.

CAUTION

Always use the included AC adapter (GPE248-120200-Z) with this unit. Never use the included AC adapter with any other device. Doing so could cause damage, fire or electric shock.

NOTE

The included AC adapter (GPE248-120200-Z) is shipped with exchangeable outlet plugs. For details about changing the outlet plug, see page 21.

Conventions used in this manual

The following conventions are used in this manual.

- "SD card" indicates SD, SDHC and SDXC memory cards.
- When we refer to a button or connector or control on the DR-680MKII, the typeface looks like this: **MENU**.
- When we show messages, for example, that appear on the screen, the typeface looks like this: **BROWSE**.
- Additional information is provided as necessary in tips, notes and cautions

TIP

These are tips about how to use the unit.

NOTE

These include additional explanations and special cases.

CAUTION

Failure to follow these instructions could result in injury, equipment damage or lost data, for example.

1 – Introduction

Intellectual property rights

- TASCAM is a trademark of TEAC Corporation, registered in the U.S. and other countries.
- SDXC Logo is a trademark of SD-3C, LLC.



- Microsoft and Windows are either registered trademarks or trademarks of Microsoft Corporation in the United States and/or other countries.
- Apple, Mac OS and Mac OS X are trademarks of Apple Inc.
- MPEG Layer-3 audio coding technology licensed from Fraunhofer IIS and Thomson. Supply of this product does not convey a license nor imply any right to distribute MPEG Layer-3 compliant content created with this product in revenue-generating broadcast systems (terrestrial, satellite, cable and/or other distribution channels), streaming applications (via Internet, intranets and/or other networks), other content distribution systems (pay-audio or audio-on-demand applications and the like) or on physical media (compact discs, digital versatile discs, semiconductor chips, hard drives, memory cards and the like). An independent license for such use is required. For details, please visit <http://mp3licensing.com>.
- Other company names, product names and logos in this document are the trademarks or registered trademarks of their respective owners.

Any data, including, but not limited to information, described herein are intended only as illustrations of such data and/or information and not as the specifications for such data and/or information. TEAC Corporation disclaims any warranty that any use of such data and/or information shall be free from infringement of any third party's intellectual property rights or other proprietary rights, and further, assumes no liability of whatsoever nature in the event of any such infringement, or arising from or connected with or related to the use of such data and/or information.

This product is designed to help you record and reproduce sound works to which you own the copyright, or where you have obtained permission from the copyright holder or the rightful licensor. Unless you own the copyright, or have obtained the appropriate permission from the copyright holder or the rightful licensor, your unauthorized recording, reproduction or distribution thereof may result in severe criminal penalties under copyright laws and international copyright treaties. If you are uncertain about your rights, contact your legal advisor. Under no circumstances will TEAC Corporation be responsible for the consequences of any illegal copying performed using the recorder.

About SD cards

This unit uses SD cards for recording and playback.

64MB–2GB SD cards, 4–32GB SDHC cards and 48–128GB SDXC cards can be used.

A list of SD cards that have been tested with this unit can be found on the TEAC Global Site (<http://teac-global.com/>).

Use of cards that have not been verified for use with this unit could result in the unit not functioning properly.

Precautions for use

SD cards are delicate media. In order to avoid damaging a card or the card slot, please take the following precautions when handling them.

- Do not leave in extremely hot or cold places.
- Do not leave them in extremely humid places.
- Do not let them get wet.
- Do not put things on top of them or twist them.
- Do not hit them.
- Do not remove or insert a card during recording, playback, data transmission or other access.
- When transporting a memory card, put it into a case, for example.

Precautions for placement and use

- The environmental temperature operating range of this unit is 0–40°C (32–104°F).
- Do not install this unit in the following types of locations. Doing so could degrade the sound quality and/or cause malfunctions.
 - Places with significant vibrations
 - Near windows or other places exposed to direct sunlight
 - Near heaters or other extremely hot places
 - Extremely cold places
 - Places with bad ventilation or high humidity
 - Very dusty locations
 - Places exposed directly to rain or other water
- Do not place this unit on top of a power amplifier or other device that generates heat.
- If this unit is placed near a power amplifier or other device with a large transformer, it could cause a hum. If this occurs, increase the distance between this unit and the other device.
- This unit could cause color irregularities on a TV screen or noise from a radio if used nearby. If this occurs, use this unit farther away.
- This unit might produce noise if a mobile phone or other wireless device is used nearby to make calls or send or receive signals. If this occurs, increase the distance between this unit and those devices or turn them off.
- To enable good heat dissipation, do not place anything on top of this unit.
- Do not place this unit on top of a power amplifier or other device that generates heat.

Beware of condensation

If the unit is moved from a cold to a warm place, or used after a sudden temperature change, there is a danger of condensation; vapor in the air could condense on the internal mechanism, making correct operation impossible. To prevent this, or if this occurs, let the unit sit for one or two hours at the new room temperature before using.

Cleaning the unit

Use a dry soft cloth to wipe the unit clean. Do not clean the unit with a chemically treated cloth or substances such as thinner and alcohol because they might cause damage to the surface of the unit.

User registration

Customers in the USA, please visit the TASCAM website (<http://tascam.com/>) to register as a user online.

2 – Names and Functions of Parts

Top panel

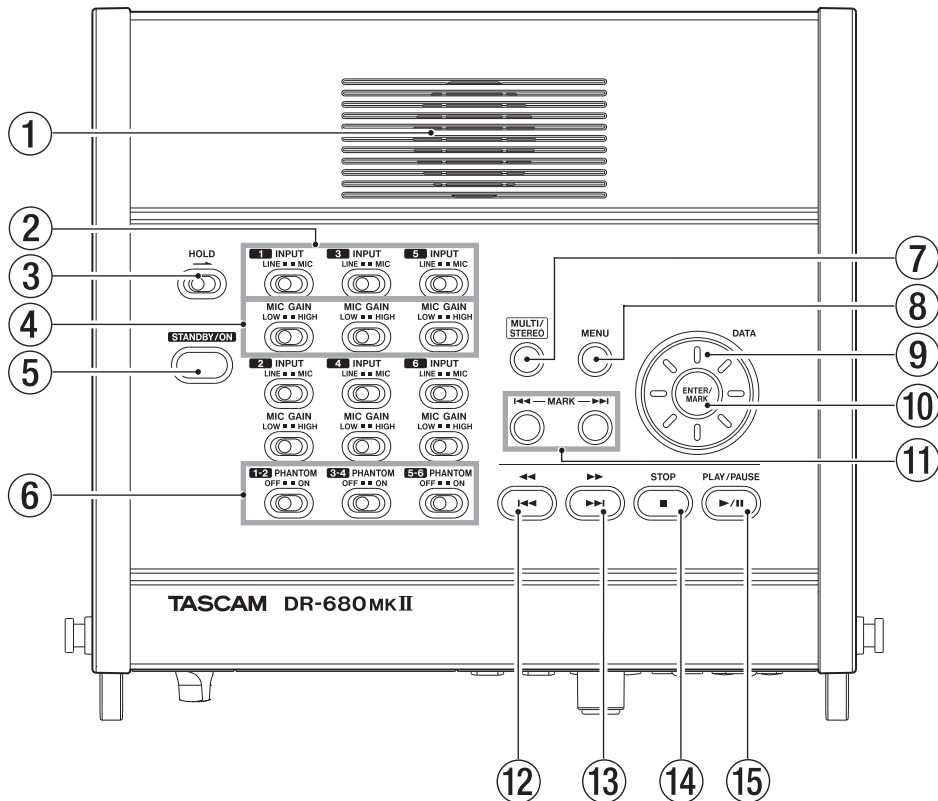

① Built-in monaural speaker

Use this built-in speaker for monitoring. Use the **PHONES** knob to adjust the volume. Sound will not be output from the speaker in the following conditions.

- When headphones are connected
- When SPEAKER output is set to OFF on the GENERAL page

② INPUT switches

Use these to set the inputs to **LINE** or **MIC**.

③ HOLD switch

Slide this in the direction of the arrow to disable the **STANDBY/ON** button to prevent the power from accidentally being cut.

④ MIC GAIN switches

Use these to adjust the gain of the mic inputs.

⑤ STANDBY/ON button

Press this to switch the unit power between **ON** and **STANDBY**.

⑥ PHANTOM switches

Use these to turn phantom power **ON** or **OFF** for input pairs 1/2, 3/4 and 5/6.

CAUTION

- Do not connect or disconnect mics when a **PHANTOM** switch is set to **ON**. Doing so could cause a loud noise and might damage this unit and connected equipment.
 - Set the **PHANTOM** switch to **ON** only when using a condenser microphone that requires phantom power. Turning phantom power on when a dynamic mic or other mic that does not require it is connected could damage this unit and connected equipment.
 - When using condenser mics that require phantom power and dynamic mics together, be sure to use balanced dynamic mics. Unbalanced dynamic mics cannot be used when phantom power is enabled.
 - Supplying phantom power to some ribbon mics will break them. If you are unsure, do not supply phantom power to a ribbon mic.
- ⑦ **MULTI/STEREO button**
Press to select whether the stereo track or the multi-track (6-track) is played back.

2 – Names and Functions of Parts

- ⑧ **MENU button**
Press this button when the Home Screen is open to open the MENU screen. (See “Menu structure” on page 16.) (See “Using menus” on page 17.)
- ⑨ **DATA wheel**
Use this to select items and change values on various settings screens.
When the Home Screen is open, use the **DATA** wheel to move the playback position in the take.
- ⑩ **ENTER/MARK button**
Use this to confirm selections, advance to the next level in a menu and respond “YES” to confirmation pop-up messages on various settings screens.
- ⑪ **MARK (◀◀/▶▶) buttons**
Use these on various settings screens to move the cursor left and right.
On the BROWSE screen, use these to move up and down levels.
Use **MARK (◀◀)** button to respond “NO” to confirmation pop-up messages on various settings screens or to cancel the current operation.
- ⑫ **◀◀[◀◀] button**
Press this button during playback or when stopped in the middle of a take to return to the beginning of the current take.
Press when stopped at the beginning of the take to skip to the beginning of the previous take.
Press and hold to search backwards.
- ⑬ **▶▶[▶▶] button**
Press this button during playback or when stopped to skip to the beginning of the next take.
Press and hold to search forward.
- ⑭ **STOP button**
Press to stop recording and playback and locate the transport to the beginning of the current take.
Press to end recording standby.
- ⑮ **PLAY/PAUSE button**
Press when stopped or paused to start playback.
Press during playback to pause at that position.

Front panel

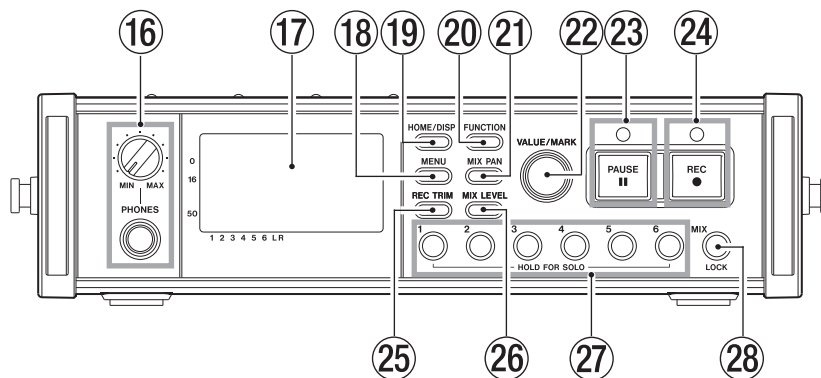

- ⑯ **PHONES jack and knob**
Use this standard stereo phone jack to connect headphones. Use the **PHONES** knob to adjust the headphones and speaker output level.
- ⑰ **Display**
This shows a variety of information related to the operation of the unit.
- ⑱ **MENU button**
Press this button when the Home Screen is open to open the MENU screen.
- ⑲ **HOME/DISPLAY button**
Press when any screen other than the Home Screen is open to return to the Home Screen.
Change the counter display mode.
- ⑳ **FUNCTION button**
When the Home Screen is open, press to open the Functions Screen.
- ㉑ **MIX PAN button**
Press to open the PAN settings screen. Press when the PAN settings screen is open to close it and return to the Home Screen.
- ㉒ **VALUE/MARK knob**
Use this to change the value of the selected item on the TRIM, LEVEL and PAN settings screens.
On the Functions Screen, use this to select function items, and press the knob to turn each function item ON or OFF.

2 – Names and Functions of Parts

Turn this knob while pressing the **HOME/DISPLAY** button on the front panel to adjust the display contrast.

When the **MENU** screen is open, this dial can be used for the same functions as the **DATA** wheel and pressing this dial has the same function as the **ENTER/MARK** button.

When the Home Screen is open, press to set a mark.

When the Home Screen is open, turn to skip to a mark.

When the **MENU** screen is open, press to move the cursor left or right.

When the **MENU** screen is open, turn to move the cursor or change a setting value.

23 PAUSE button and indicator

Press when stopped or recording to start recording standby. The indicator lights when in recording standby.

Press when in recording standby to stop recording standby.

NOTE

The PAUSE button on the front panel functions only when recording. Use the PLAY/PAUSE button on the top of the unit to pause playback.

24 REC button and indicator

Press when stopped or in recording standby to start recording. The indicator lights when recording or in recording standby.

Press this button when recording to end the current take and continue recording a new take without pause.

25 REC TRIM button

Press to open the input **TRIM** settings screen.

When the input **TRIM** settings screen is open, press to close it and open the Home Screen.

26 MIX LEVEL button

Press to open the **LEVEL** settings screen.

Press when the **LEVEL** settings screen is open to close it and return to the Home Screen.

27 Channel number buttons (1–6 buttons)

Use these to select tracks on the **TRIM**, **LEVEL** and **PAN** settings screens.

Press when in recording standby to arm/disarm that track for recording.

On the Functions Screen, press to turn the selected function **ON** or **OFF** for that track.

Press and hold to enable/disable solo monitoring of that track.

28 MIX [LOCK] button

When the **LEVEL** screen is open, this selects the stereo track as the track to be controlled. Press and hold this button to engage or disengage the lock function, which disables the use of other buttons.

Left side panel

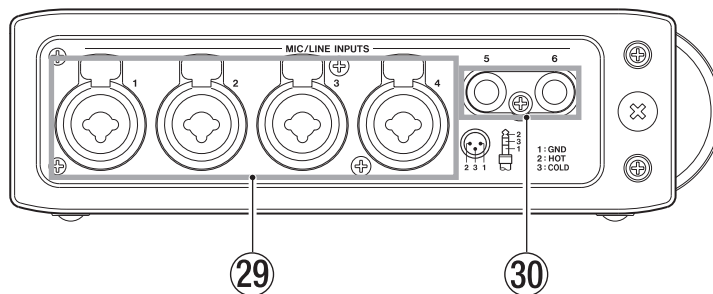

29 MIC/LINE INPUTS (XLR/TRS) jacks

These are balanced analog XLR/TRS combo jacks for microphone and line level inputs (1: GND 2: HOT 3: COLD, Tip: HOT Ring: COLD Sleeve: GND).

30 MIC/LINE INPUTS (TRS) jacks

These are balanced analog TRS jacks for microphone and line level inputs (Tip: HOT Ring: COLD Sleeve: GND).

CAUTION

- Confirm that phantom power is **OFF** before connecting a line level device to a **MIC/LINE INPUTS** jack. If you connect a line level device while phantom power is

being supplied, that device and this unit could be damaged.

- When using a condenser microphone, before connecting to and disconnecting from a **MIC/LINE INPUTS** jack, confirm that the phantom power for that jack is **OFF**. If you connect or disconnect a mic while phantom power is being supplied, that mic and this unit could be damaged.
- Do not connect an unbalanced dynamic mic to an XLR connector when phantom power is being supplied. Doing so could damage that mic and this unit.

2 – Names and Functions of Parts

Right side panel

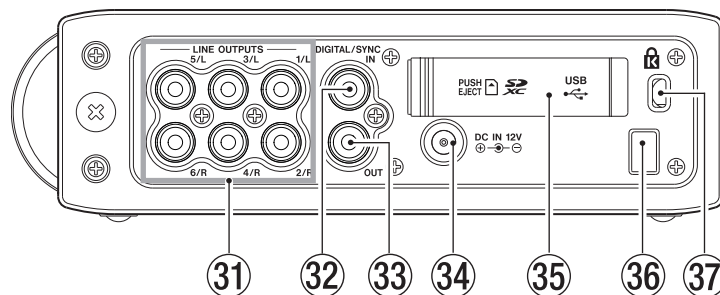

31 LINE OUTPUTS jacks

These RCA pin jacks are unbalanced analog output jacks. During the playback of multitrack files, the sound previously recorded on each track is output from these jacks.

During recording, the sound recorded to each track is output from these jacks.

During the playback of the multi-track, according to the unit setting, the stereo signal mixed by the internal mixer can be output from output jacks 1/2, 3/4 or 5/6.

During the playback of a stereo track, the sound of the stereo track is output through output jacks 1/2, 3/4 or 5/6.

32 DIGITAL/SYNC IN jack

This is a digital input jack. The signal input through this jack can be recorded to tracks 5 and 6 or the stereo track. The unit automatically determines whether the input signal is S/PDIF (IEC60958-3) or AES3-2003/IEC60958-4 (AES/EBU), which are both supported.

Transmission occurs at double speed when the sampling frequency is 96 kHz and at quad speed when 192 kHz.

When linking two of these units using the cascade function, connect the **DIGITAL/SYNC OUT** jack of the other DR-680MKII to this jack.

33 DIGITAL/SYNC OUT jack

The stereo signal mixed by the internal mixer is output from this jack.

According to the unit setting, the signal is output in S/PDIF (IEC60958-3) or AES3-2003/IEC60958-4 (AES/EBU) format.

Transmission occurs at double speed when the sampling frequency is 96 kHz and at quad speed when 192 kHz.

When linking two of these units using the cascade function, connect the **DIGITAL/SYNC IN** jack of the other DR-680MKII to this jack.

34 DC IN 12V jack

Connect the included AC adaptor (GPE248-120200-Z), which matches the power specifications of this unit.

35 SD card slot/USB port cover

36 Cord holder

Secure the cord of the included AC adaptor (GPE248-120200-Z) with this holder to prevent the plug from being disconnected accidentally.

37 Kensington security slot

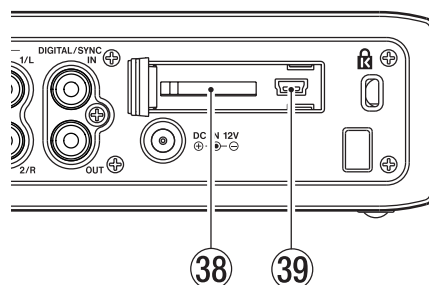

38 SD card slot

Insert SD cards here.

39 USB port

Connect this unit with a computer using a USB2.0 cable. The computer will recognize this unit as a mass storage device. No driver software is necessary.

Audio files can be transferred between an SD card in this unit and a computer by the USB connection.

2 – Names and Functions of Parts

Bottom panel

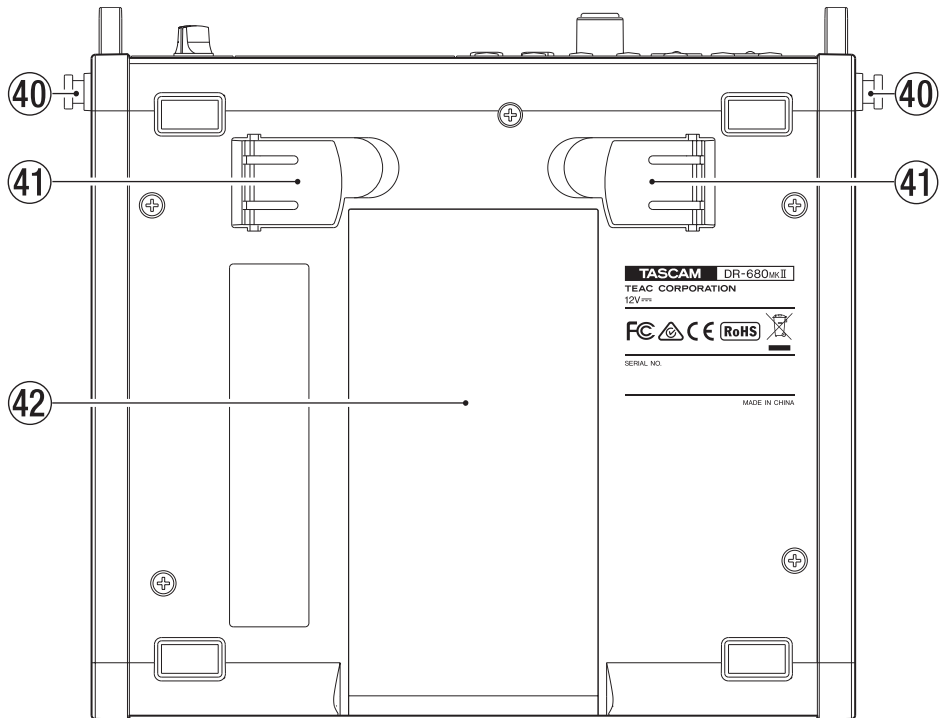

- ④① **Hook for the shoulder strap**
Attach the included shoulder strap here.

- ④② **Battery compartment cover**

- ④① **Stand**
Use this stand to raise the front of the unit when operating it on a flat surface.

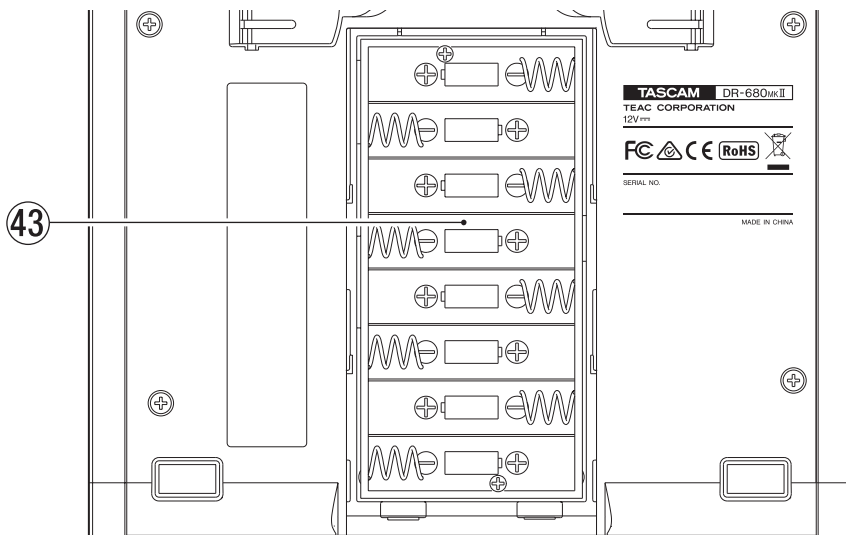

- ④③ **Battery compartment**
Install batteries (8 AA) for powering the unit in this compartment. (See "Using AA batteries" on page 20.)

2 – Names and Functions of Parts

Home Screen

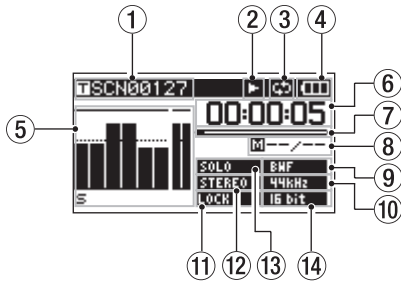

① Take name

When stopped or during playback, the name of the currently loaded take is shown.

When recording or in recording standby, the name of the take being recorded is shown.

Up to 11 characters are shown. Longer names are scrolled.

② Recorder operation status

The operation status of the recorder is shown with one of the following icons.



- : Stopped
- ▶: Playing back
- ⏸: Paused
- ▶▶: Searching forward
- ◀◀: Searching backwards
- : Recording
- ||: Recording standby
- ⏭: Skip forward
- ⏮: Skip backward

③ Repeat icon

When the repeat function is ON, the repeat icon  appears.

④ Power supply status

When operating on battery power, a battery icon appears.

Depending on the amount of remaining battery power, a number of bars appear (, , or ).

When the battery charge is very low, the last bar disappears, the  icon blinks, and the unit's power will soon change to standby.

When using the included AC adaptor (GPE248-120200-Z), the  icon appears.

NOTE

Even before the batteries lose their charge, a "Battery Low" warning pop-up message might appear if you try to start recording or conduct another operation that requires considerable power.

⑤ Level meters

These show the levels of tracks 1–6 and the stereo track.

When recording, if stereo track recording is ON and the stereo track recording source is set to DIGITAL IN, the stereo track meters become the DIGITAL IN input level meters.

During playback of a multitrack file, the playback levels of each track are shown.

When recording, the recording levels of each track are shown.

When recording, if a signal is distorted at the input stage, the area beneath its meter is highlighted.

If a recording level exceeds 2.0 dB below the maximum level, a mark appears at the top of its meter, indicating an overload.

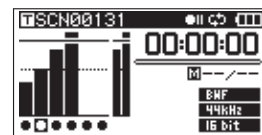

Ch2: Signal is distorted at the input stage

Ch4: Recording level exceeds 2.0dB less than the maximum level.

During stereo track playback, the meters for tracks 1 and 2 function as the L and R meters.

When a track is armed for recording, "●" appears beneath its meter.

When a track is soloed, "S" appears beneath its meter.

NOTE

If a track is both armed for recording and soloed, only "S" appears beneath its meter.

⑥ Time (hours: minutes: seconds)

During playback, the elapsed playback time of the take is shown.

Press the **HOME/DISPLAY** button on the front panel to show the remaining time of the take as a negative number.

When recording, the elapsed recording time of the take is shown.

Press the **HOME/DISPLAY** button on the front panel to show the remaining available recording time for the take.

⑦ Playback position

This bar shows the current playback position during playback or the amount of remaining time available for recording during recording. As recording or playback progresses, the bar darkens from the left.

⑧ Mark information

The mark number and the total number of marks in the current take are shown.

During playback, the number of the mark that is before and closest to the current position is shown.

When recording, the last added mark number is shown.

2 – Names and Functions of Parts

9 File type indicator

When stopped or during playback, the file type of the currently loaded take is shown.

When recording or in recording standby, the file type of the take being recorded is shown.

BWF : BWF

WAV : WAV

MP3 : MP3

10 Sampling frequency indicator

When stopped or during playback, the sampling frequency of the currently loaded take is shown.

When recording or in recording standby, the sampling frequency of the take being recorded is shown.

441kHz : 44.1 kHz

48kHz : 48 kHz

96kHz : 96 kHz

192kHz : 192 kHz

11 LOCK indicator

When the lock function for the front panel and/or top panel buttons is ON, the **LOCK** indicator appears.

12 STEREO indicator

When a stereo track is being played, the **STEREO** indicator appears. During stereo track playback, the meters for tracks 1 and 2 function as the L and R meters.

13 SOLO indicator

When a track has been soloed, the **SOLO** indicator appears. An  icon appears beneath the meter of the currently soloed track.

14 Quantization/bit-rate indicator

When stopped or during playback, the quantization/bit-rate of the currently loaded take is shown.

When recording or in recording standby, the quantization/bit-rate of the take being recorded is shown.

When the take being recorded or played is an MP3, its bit rate is shown.

BWF/WAV

16 bit : 16-bit

24 bit : 24-bit

MP3

96Kbps : 96 kbps (48 kbps)

128Kbps : 128 kbps (64 kbps)

192Kbps : 192 kbps (96 kbps)

320Kbps : 320 kbps (160 kbps)

NOTE

The bit rate in parentheses is for when recording a monaural take.

Menu structure

When you press the **MENU** button on the top or front of the unit, the **GENERAL** menu page will open.

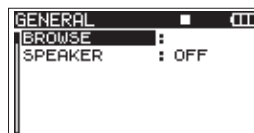

The MENU screen has 8 pages organized by types of menu items.

- GENERAL page
- REC page
- AUTO REC page
- LOW CUT page
- I/O page
- PLAY page
- CARD page
- SYSTEM page

The menu items are as follows.

Menu item	Function	Reference
GENERAL page		
BROWSE	Open BROWSE screen	page 38
SPEAKER	Set the built-in speaker	page 23
REC page		
FORMAT	Set recording file format	page 24
SAMPLE	Set sampling frequency	page 25
DUAL REC	Set dual recording	page 31
FILE	Set recording file mode	page 25
TRACK	Set recording track	page 25
ST REC	Set stereo track recording	page 25
PAUSE	Set recording after recording pauses	page 26
NAME	Set take name format	page 27
TAKE NO. INIT	Reset take name numbering	page 27
AUTO REC page		
LEVEL	Set automatic recording function	page 32
SILENT CUT	Set silence cutting function	page 33
SILENT DELAY		
AUTO MARK	Set automatic mark function	page 33
LOW CUT page		
FREQUENCY	Set low cut filter	page 35
I/O page		
INPUT 5/6	Set the recording source for tracks 5 and 6	page 29

2 – Names and Functions of Parts

Menu item	Function	Reference
LINE OUT	Set analog output	page 48
DIGITAL OUT	Set digital output	page 49
PLAY page		
AREA	Set playback area	page 42
SEARCH SPEED	Set search speed	page 42
CARD page		
INFORMATION	Show SD card information	page 51
FORMAT	Format SD card	page 51
SYSTEM page		
AUTO OFF	Set automatic powering off	page 49
BACKLIGHT	Set display backlight	page 49
CASCADE	Set cascade connection	page 50
LOCK MODE	Set lock function	page 50
BATTERY	Set battery type	page 50
INITIALIZE	Restore default settings	page 50
INFORMATION	View system information	page 50
DATE/TIME	Set date and time	page 22

NOTE

- When recording or in recording standby, pressing a **MENU** button will not open the **MENU** screen.
- The settings for all menu items are retained even when the unit is turned off.

Using menus

In this example, we show how to change the sampling frequency.

1. Press the **MENU** button on the top or front of the unit to open the **GENERAL** page of the **MENU** screen.

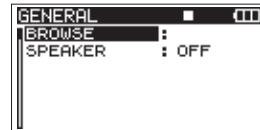

2. Press the **MENU** button to open the menu page.
3. Turn the **DATA** wheel on the top or the **VALUE/MARK** knob on the front of the unit to select (highlight) a setting item.

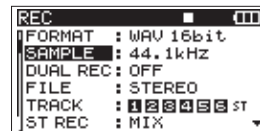

4. Press the **ENTER/MARK** button on the top or the **VALUE/MARK** knob on the front to move the cursor to the setting value.

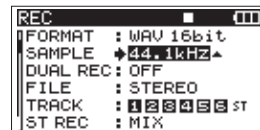

5. Turn the **DATA** wheel on the top or the **VALUE/MARK** knob on the front of the unit to change the setting.
6. To set another item on the same screen, press the **MARK** (|◀▶) button on the top of the unit. This enables setting item selection again. Turn the **DATA** wheel on the top or the **VALUE/MARK** knob on the front of the unit to select (highlight) the desired setting item.
7. Repeat steps 4–6 as necessary to set other items.
8. Press the **HOME/DISP** button on the front of the unit to return to the Home Screen.

2 – Names and Functions of Parts

Operation basics

Use the following controls to operate the various settings screens.

MENU button

Press to open the MENU screen when it is not already open.

This unit has two of these buttons — one on its top and one on its front.

DATA wheel

Use to select items and to change values.

You can also use the **VALUE/MARK** knob instead for the same functions.

ENTER/MARK button

Press to confirm the selection of a setting item, and to select “YES” on a confirmation pop-up message.

You can also press the **VALUE/MARK** knob instead for the same function.

MARK (▶▶) button

Press to move the cursor right in a settings screen and to open a folder on the BROWSE screen.

MARK (◀◀) button

Press to move the cursor left in a settings screen and to close a folder on the BROWSE screen.

Press to select “NO” on a confirmation pop-up message.

HOME/DISP button

When a settings screen is open, press the **HOME/DISP** button to return to the Home Screen.

Functions Screen

When the Home Screen is open, press the **FUNCTION** button to open the Functions Screen.

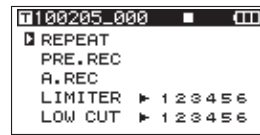

On the Functions Screen, you can view and activate the following items.

- Repeat
- Pre-record
- Auto-record
- DIN/MIX monitor
- Limiter
- Low-cut filter

1. When the Home Screen is open, press the **FUNCTION** button to open the Functions Screen.
2. Use the **VALUE/MARK** knob to move the cursor to select the item to set.
3. Press the **VALUE/MARK** knob.
When selecting **LIMITER** or **LOW CUT**, press the **VALUE/MARK** knob or channel number (**1–6**) buttons.
4. When you have finished making the settings, press the **HOME/DISP** button to return to the Home Screen.

Repeat activation

Use the **REPEAT** item to turn loop playback ON or OFF. The default value is OFF.

REPEAT : Repeat playback ON

REPEAT : Repeat playback OFF

Pre-record activation

Use the **PRE.REC** item to turn the pre-record function ON or OFF. The default value is OFF.

PRE.REC : Pre-record ON

PRE.REC : Pre-record OFF

Auto-record activation

Use the **A.REC** item to turn the auto-record function ON or OFF. The default value is OFF.

A.REC : Auto-record function ON

A.REC : Auto-record function OFF

DIN/MIX monitor settings

When the **ST REC** item on the **REC** page of the **MENU** screen is set to **DIN**, the signal to be monitored can be selected. Press the **VALUE/MARK** knob to select **DIN MON** or **MIX MON**.

The default value is **MIX MON**.

MIX MON : Set to monitor the stereo mix

DIN MON : Set to monitor the digital input

NOTE

*When the **ST REC** item on the **REC** page is set to **MIX**, this setting is fixed to **MIX MON**, and it cannot be changed to **DIN MON**.*

Limiter activation

Use the **LIMITER** item to turn the limiter function ON or OFF for each input independently.

The limiter for an input is ON when its number appears light on a dark background. The default value is OFF for all inputs.

Press the **VALUE/MARK** knob to turn the limiter ON or OFF for all inputs at the same time.

Press the channel number (**1–6**) buttons to turn the limiter ON or OFF for each input independently.

If the limiter has been turned ON for one or more inputs, the **LIMITER** indicator appears with a dark background.

LIMITER ▶ **123456** : Limiter ON for all inputs

LIMITER ▶ **1 2 3 4 5 6** : Limiter ON for input 1

LIMITER ▶ **1 2 3 4 5 6** : Limiter OFF for all inputs

Low-cut filter activation

Use the **LOW CUT** item to turn the low-cut filter function ON or OFF for each input independently.

The low-cut filter for an input is ON when its number appears light on a dark background. The default value is OFF for all inputs.

Press the **VALUE/MARK** knob to turn the low-cut filter ON or OFF for all inputs at the same time.

Press the channel number (**1–6**) buttons to turn the low-cut filter ON or OFF for each input independently.

If the low-cut filter has been turned ON for one or more inputs, the **LOW CUT** indicator appears with a dark background.

LOW CUT ▶ **123456** : Low-cut filter ON for all inputs

LOW CUT ▶ **1 2 3 4 5 6** : Low-cut filter function ON for input 1

LOW CUT ▶ **1 2 3 4 5 6** : Low-cut filter OFF for all inputs

NOTE

*You can set the cut-off frequency with the **FREQUENCY** item of the **LOW CUT** menu. (See "Using the low-cut filter" on page 35.)*

3 – Preparations

Powering the unit

About the power supply

This unit can be powered by 8 AA batteries or the included GPE248-120200-Z AC adaptor, which matches the power specifications of this unit.

This unit can use alkaline, Ni-MH or lithium AA batteries.

Using AA batteries

Slide off the battery compartment cover on the bottom panel of this unit, insert 8 AA batteries into the battery compartment according to the \oplus/\ominus indications, and close the compartment cover again.

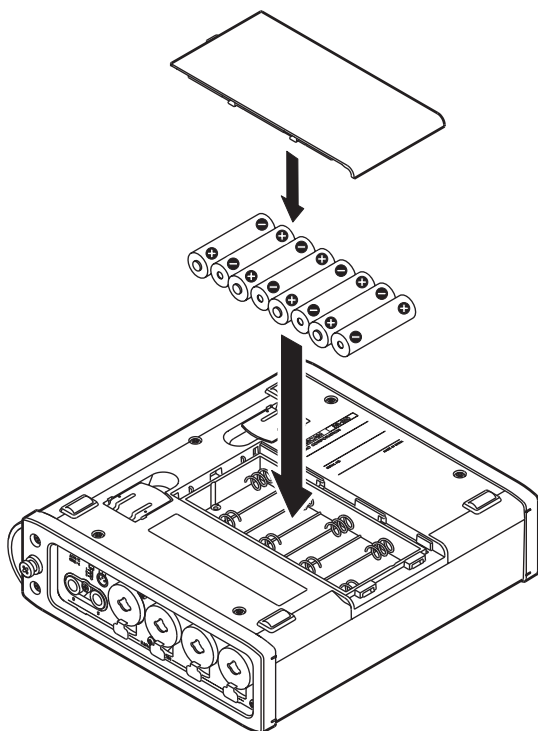

When using AA batteries, set the battery type so that the unit can accurately display the remaining battery charge and determine the necessary minimum remaining charge for operation. (See "Setting the battery type" on page 50.)

CAUTION

- Manganese AA batteries cannot be used.
- This unit cannot recharge AA nickel-metal hydride (NiMH) batteries. Use a commercially-available battery recharger to recharge NiMH batteries.

NOTE

A great amount of power is required to provide phantom power to a condenser microphone. If you use a condenser microphone while running the unit

on AA batteries (NiMH rechargeable or alkaline), the operation time will be greatly shortened. If you need to operate the unit for a long time, use the included GPE248-120200-Z AC adaptor.

Using the AC adaptor

As shown in the figure, connect the included GPE248-120200-Z AC adaptor, which conforms to the specifications of this unit, to the **DC IN 12V** jack.

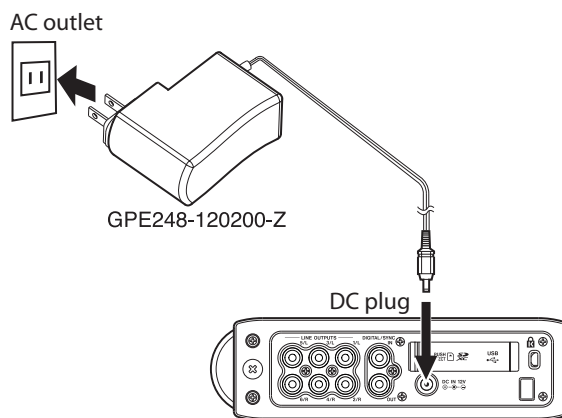

A hook (cord holder) to fix the cord of the AC adaptor is on the right side panel. Wrap the cord around the hook when connecting it to prevent it from being disconnected during use.

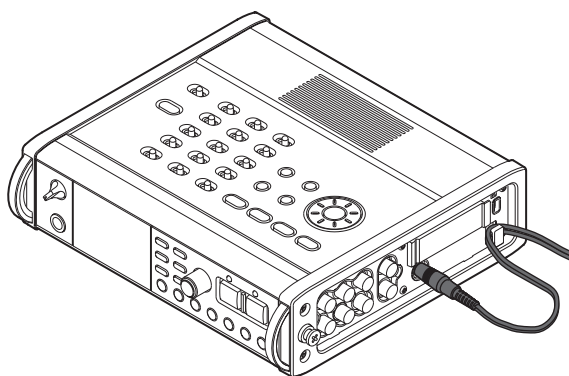

CAUTION

Use only the included GPE248-120200-Z AC adaptor, which conforms to the specifications of this unit. Use of an adaptor other than this model could cause malfunction, fire or electric shock.

NOTE

- If power is available from both batteries and the AC adaptor, the power is supplied by the AC adaptor.
- The AC adapter for the unit includes two types of outlet plugs. Attach the type of plug that matches the power outlet that you are using.

Changing the outlet plug

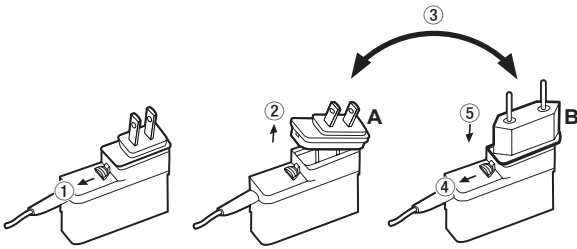

- ① Move the latch on the AC adapter in the direction of the arrow.
- ② Pull off the outlet plug.
- ③ Replace it with the other outlet plug (A or B).
- ④ Move the latch on the AC adapter in the direction of the arrow again.
- ⑤ Attach the outlet plug to the AC adapter.

This completes changing the outlet plug.

After changing the outlet plug, confirm that it is not loose or crooked and that everything is normal before plugging it into an outlet.

CAUTION

Do not use the adapter if there is anything abnormal about the plug after changing it. Use when the plug is abnormal could cause fire or electric shock. Contact the retailer where you purchased the unit or a TEAC service center (on the back cover) to request repair.

Turning the power on and putting the unit into standby

Turning the power on

When the power is in standby, press and hold the **STANDBY/ON** button until the startup screen with **TASCAM DR-680MKII** appears. The unit starts up and the Home Screen opens.

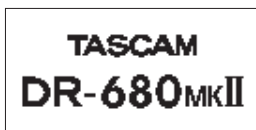

CAUTION

Do not remove or insert an SD card until the Home Screen appears.

Putting the unit into standby

When the power is ON, press and hold the **STANDBY/ON** button until the following shutdown screen appears.



After the unit completes shutting down, the unit's power is set to standby.

CAUTION

Always use the STANDBY/ON button to put the unit power into standby. When the power is ON, if you remove the batteries or disconnect the power cord when using the GPE248-120200-Z AC adaptor, all recording data and settings, for example, are lost and such data cannot be recovered.

Inserting and removing SD cards

64MB–2GB SD cards, 4–32GB SDHC cards and 48–128GB SDXC cards can be used.

A list of SD cards that have been verified for use with this unit can be found on the TEAC Global Site (<http://teac-global.com/>).

Inserting an SD card

1. Open the SD card slot cover on the right side panel of the unit.
2. Insert the SD card in the direction shown in the illustration until it clicks into place.

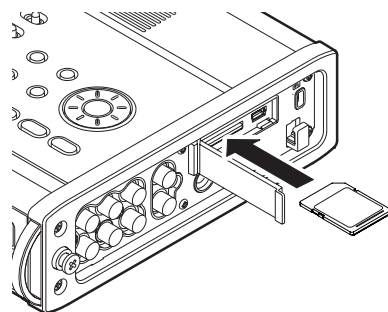

3 – Preparations

Ejecting an SD card

CAUTION

- Do not remove the SD card from the unit during recording, playback or at other times when it is being accessed.
- Do not remove the SD card from the unit when it is connected to a computer by USB.
- SD cards that meet SD, SDHC or SDXC standards can be used with this unit.
- A list of SD cards that have been confirmed to work with this unit can be found on the TEAC Global Site (<http://teac-global.com/>).

1. Open the SD card slot cover.
2. Push the SD card gently, and it will come out of the unit slightly and can be pulled out.

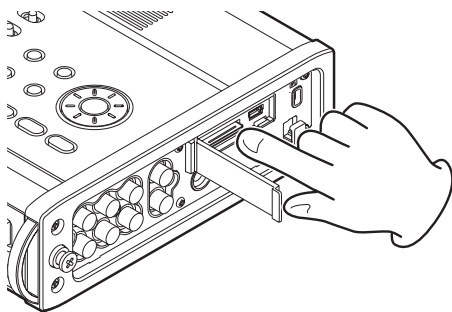

Preparing an SD card for use

An SD card must be formatted by this unit to be used with the unit.

CAUTION

- Formatting erases all data on the card.
- When formatting, use the included AC adaptor (GPE248-120200-Z) or confirm that the remaining battery charge is sufficient.

1. Confirm that the SD card is inserted and turn the power ON.
2. If a new card or a card that has been formatted by a device other than this unit has been inserted, the following pop-up message appears.



3. Press the **ENTER/MARK** button to start formatting.
4. When formatting is complete, the Home Screen opens. You can reformat a card at any time with this unit. (See "Reformatting SD cards" on page 51.)

Card write-protection

SD cards have lock (write-protection) switches.

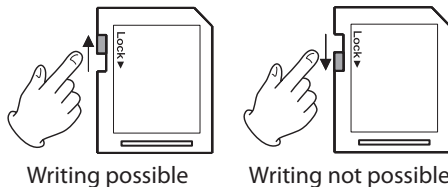

Slide the switch in the direction of the Lock arrow to prevent the recording and editing of files on the card. To record, erase or otherwise change files on a card, disable the write-protection.

Setting the date and time

This unit adds date and time information to recorded files using its internal clock.

1. Press the **MENU** button to open the **SYSTEM** page of the **MENU** screen.

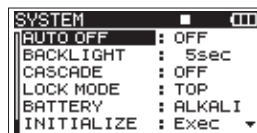

2. Use the **DATA** wheel to select the **DATE/TIME** menu item.

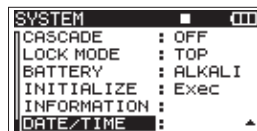

3. Press the **ENTER/MARK** button to open the **DATE/TIME** screen.



4. Use the **MARK** (**◀◀/▶▶**) buttons to move the cursor and use the **DATA** wheel to change the values.
5. Press the **ENTER/MARK** button to confirm and return to the **MENU** screen.
6. Press the **MENU** or **HOME/DISP** button to return to the Home Screen.

NOTE

You can add the date and time set here to the take name. (See "Setting the name given to recording takes" on page 26.)

3 – Preparations

Turning the built-in speaker output on and off

When shipped new from the factory, this unit's built-in speaker output is set to on. To turn the built-in speaker output off, set the **SPEAKER** item on the **GENERAL** page to off.

1. Press the **MENU** button to open the **GENERAL** page of the **MENU** screen.
2. Use the **DATA** wheel to select the **SPEAKER** item, and press the **ENTER/MARK** button.

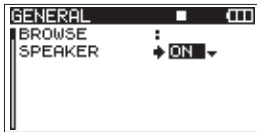

3. Use the **DATA** wheel to select one of the following settings.
Options: OFF, ON (default)
4. Press the **MARK** (I◀◀) button to return to item selection on the **MENU** screen.
5. Press the **HOME/DISP** button to return to the Home Screen.

CAUTION

*Before using the built-in speaker, turn the **PHONES** knob to the minimum volume. Failure to do so could cause sudden loud noises to occur, which might damage your hearing or equipment.*

NOTE

When headphones are connected, no sound is output from the speaker.

Connecting monitoring equipment

To monitor with headphones, connect them to the **PHONES** jack. Use the **PHONES** knob to adjust the headphones volume.



CAUTION

*Before connecting headphones, turn the **PHONES** knob to the minimum volume. Failure to do so could cause*

sudden loud noises to occur, which might damage your hearing or equipment.

To monitor with an external monitoring system (powered monitor speakers or an amplifier and speakers), connect it to the **LINE OUTPUTS** jack.

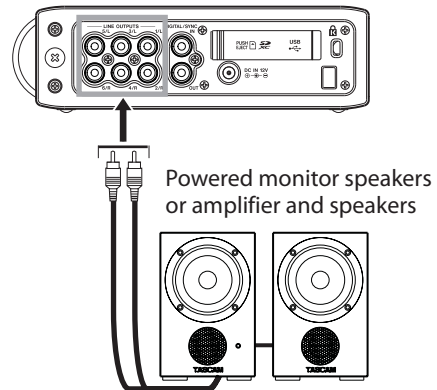

CAUTION

Before using an external monitoring system, turn the volume to minimum. Failure to do so could cause sudden loud noises to occur, which might damage your hearing or equipment.

Adjusting the display contrast

Turn the **VALUE/MARK** knob while pressing and holding the **HOME/DISPLAY** button to adjust the display contrast.

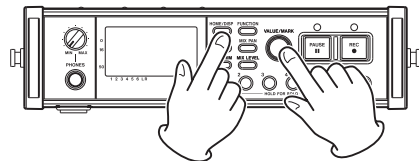

4 – Recording

This unit can record in the following formats.

- WAV/BWF (16/24-bit, 44.1 k/48 k/96 kHz)
6 tracks and a stereo mix
- WAV/BWF (16/24-bit, 192 kHz)
2 tracks
- MP3 (96/128/192/320 kbps, 44.1 k/48 kHz)
4 tracks
2 tracks and a stereo mix

Files and takes

With this unit, a group of audio files that are recorded at the same time are collectively called a “take.”

Depending on the file recording mode setting, the files included in the recorded take will be as follows.

Example 1: 6 tracks and a stereo track recorded

- MONO format set: 6 mono WAV files and a stereo WAV file
- STEREO format set: 3 stereo WAV files of inputs pairs 1-2, 3-4 and 5-6 and a stereo WAV file of the mix
- 6ch format set: a 6-channel WAV file and a stereo WAV file

Example 2: 4-track recording in MP3 format

- MONO format set: 4 mono MP3 files
- STEREO format set: 2 stereo MP3 files

An SD card in this unit can have up to 5000 files and folders and 1000 takes.

When using a folder that contains a large number of files, starting recording can take time and the beginnings of recordings might be cut off. To prevent this, use a folder that contains as few takes as possible or put the unit in recording standby before recording. Moreover, if a folder contains a large number of files, the same issues can occur when starting a new take while continuing to record. (This occurs when you press the **REC** button during recording and automatically if the maximum file size is exceeded. For details, see “Track incrementation” on page 34.)

NOTE

- *You should use a folder that contains as few takes as possible when planning to create new takes while recording.*
- *To avoid these problems, the maximum number of takes in a folder is about 100.*

Recording settings

Setting the recording file format

You can set the recording file format (BWF/WAV/MP3) and bit depth (BWF/WAV) or bit rate (MP3).

NOTE

- *WAV format recordings have a higher audio quality than MP3 format recordings.*
 - *BWF, which is the broadcast wave format, has the same sound quality as the standard wave (WAV) format.*
 - *MP3 format allows greater recording time than WAV format.*
 - *With MP3 formats, higher bit rates record with better audio quality.*
 - *For information about recording times, see “Recording times” on page 37.*
 - *When the file format is set to MP3, the maximum number of tracks is limited to 4 (4 mono, 2 stereo, or 2 mono and 1 stereo).*
1. Press the **MENU** button to open the REC page of the MENU screen.
 2. Use the **DATA** wheel to select the **FORMAT** item, and press the **ENTER/MARK** button.

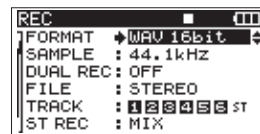

3. Use the **DATA** wheel to select one of the following options:
BWF-16bit,
BWF-24bit,
WAV-16bit (default value),
WAV-24bit,
MP3-96kbps,
MP3-128kbps,
MP3-192kbps, or
MP3-320kbps.
4. Press the **MARK** (◀◀) button to return to item selection on the MENU screen.
5. Press the **HOME/DISP** button to return to the Home Screen.

Setting the sampling frequency

You can set the sampling frequency and record BWF and WAV files at 44.1, 48, 96 or 192 kHz.

1. Press the **MENU** button to open the REC page of the MENU screen.
2. Use the **DATA** wheel to select the **SAMPLE** item, and press the **ENTER/MARK** button.



3. Use the **DATA** wheel to select one of the following options: 44.1kHz (default value), 48kHz, 96kHz, or 192kHz.

NOTE

When the file format is MP3, 96 kHz and 192 kHz cannot be selected.

4. Press the **MARK** (I◀◀) button to return to item selection on the MENU screen.
5. Press the **HOME/DISP** button to return to the Home Screen.

Setting the file recording mode

The file recording mode can be set to a monaural file, a stereo file or a 6-channel file.

1. Press the **MENU** button to open the REC page of the MENU screen.
2. Use the **DATA** wheel to select the **FILE** item, and press the **ENTER/MARK** button.



3. Use the **DATA** wheel to select one of the following options: MONO, STEREO (default value), or 6ch.

NOTE

- *When set to MONO, a mono file is created for each recorded track. When set to STEREO, a stereo file is created for each pair of tracks (1-2, 3-4 and 5-6). When set to 6ch, one 6-channel file is created for tracks 1-6.*
 - *6ch cannot be selected when the file format is set to MP3 or the sampling frequency is set to 192 kHz.*
 - *When dual recording is enabled, only MONO can be selected. (See "Enabling dual recording" on page 31.)*
4. Press the **MARK** (I◀◀) button to return to item selection on the MENU screen.
 5. Press the **HOME/DISP** button to return to the Home Screen.

Stereo track recording settings

You can set what is recorded on the stereo track.

1. Press the **MENU** button to open the REC page of the MENU screen.
2. Use the **DATA** wheel to select the **ST REC** item, and press the **ENTER/MARK** button.

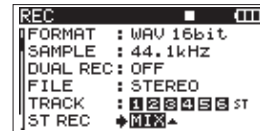

3. Use the **DATA** wheel to select one of the following options.

MIX (default): Record a mix of the 6 inputs on the stereo track.

DIN: Record the signal from the **DIGITAL/SYNC IN** input jack on the stereo track.

4. Press the **MARK** (I◀◀) button to return to item selection on the MENU screen.
5. Press the **HOME/DISP** button to return to the Home Screen.

Arming and disarming tracks for recording

Tracks can be armed and disarmed for recording from the MENU screen.

1. Press the **MENU** button to open the REC page of the MENU screen.
2. Use the **DATA** wheel to select (highlight) the **TRACK** item, and press the **ENTER/MARK** button.

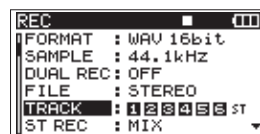

3. Use the channel number (1–6) buttons on the front panel to arm/disarm recording for the corresponding tracks. When a track is armed for recording, its track number appears light on a dark background.

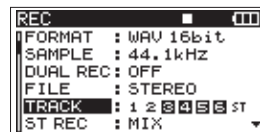

4. Press the **MARK** (I◀◀) button to return to item selection on the MENU screen.
5. Press the **HOME/DISP** button to return to the Home Screen.

4 – Recording

Creation of new takes when restarting recording

Set whether the unit continues recording to the same take or begins a new take when restarting recording. This setting determines the take recorded to when you press the **REC** button again after having pressed the **PAUSE** button to put the unit in recording standby.

1. Press the **MENU** button to open the **REC** page of the **MENU** screen.
2. Use the **DATA** wheel to select the **PAUSE** item, and press the **ENTER/MARK** button.

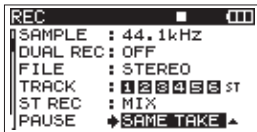

3. Use the **DATA** wheel to select one of the following options.
SAME TAKE (default value): Continue recording to the same take.
NEW TAKE: Record to a new take.
4. Press the **MARK** (**I◀◀**) button to return to item selection on the **MENU** screen.
5. Press the **HOME/DISP** button to return to the Home Screen.

Setting the name given to recording takes

Set whether take names are based on the date or one of three names that have been created on the **NAME EDIT** screen.

1. Press the **MENU** button to open the **REC** page of the **MENU** screen.
2. Use the **DATA** wheel to select the **NAME** item, and press the **ENTER/MARK** button.



3. Use the **DATA** wheel to select one of the following options.
DATE (default value): The take name is based on the date.
USER 1: The take name is based on a user word defined on the **USER WORD EDIT** screen.
USER 2: The take name is based on a user word defined on the **USER WORD EDIT** screen.
USER 3: The take name is based on a user word defined on the **USER WORD EDIT** screen.
4. Press the **MARK** (**I◀◀**) button to return to item selection on the **MENU** screen.
5. Press the **HOME/DISP** button to return to the Home Screen.

Editing the user take names

You can edit the user words used for take names on the NAME EDIT screen.

1. Press the **MENU** button to open the REC page of the MENU screen.
2. Use the **DATA** wheel to select the NAME item, and press the **ENTER/MARK** button.



3. Press the **MARK** (▶▶) button again to open the USER WORD edit screen.

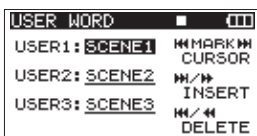

4. Use the **DATA** wheel to select the user word that you want to edit, and press the **ENTER/MARK** button.

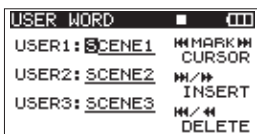

5. Use the following buttons to edit the user words.

MARK (◀◀/▶▶) buttons: Move the cursor.

DATA wheel: Select characters.

▶▶ [▶▶] button: Add a space at the cursor position.

◀◀ [◀◀] button: Erase the character at the cursor position

6. When you have finished editing a user word, press the **ENTER/MARK** button.

7. Press the **HOME/DISP** button to return to the Home Screen.

Resetting take name numbering

1. Press the **MENU** button to open the REC page of the MENU screen.
2. Use the **DATA** wheel to select the TAKE NO. INIT item.



3. Press the **ENTER/MARK** button to open the confirmation pop-up message.

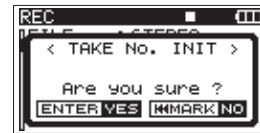

4. Press the **ENTER/MARK** button again to reset the number that follows the characters to "0000". Press the **MARK** button on the top of the unit to return to item selection on the REC page.

5. Press the **HOME/DISP** button to return to the Home Screen.

Available recording time display

Available recording time varies according to the SD card capacity and the file format, file mode and sampling frequency settings. (See "Recording times" on page 37.)

You can check the amount of time available for recording using the inserted SD card on the Home Screen. When recording or in recording standby press the **HOME/DISPLAY** button to switch between showing the elapsed recording time (of the current recording) and the remaining available recording time. When the remaining available recording time is shown, it appears as a negative number.

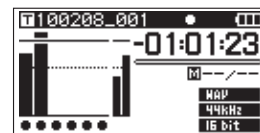

Set the folder for saving takes

You can set the folder where recorded takes are saved. (See "Folder operations" on page 39.) By default, recorded takes are saved in the "PROJECT0000" folder that is automatically created under the "MUSIC" folder.

4 – Recording

Connecting other equipment

Connect microphones and other external equipment as shown in the figure below.

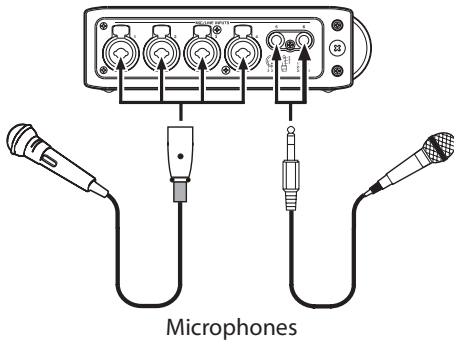

Input settings

This unit has 6 analog mic/line inputs and a stereo digital input.

6 tracks and a stereo track can be recorded for a total of 8 tracks.

The inputs recorded on the tracks are as follows.

Track	Input
Tracks 1/2	Analog inputs 1/2
Tracks 3/4	Analog inputs 3/4
Tracks 5/6	Analog inputs 5/6 or digital input
Stereo track	Stereo mix of inputs 1–6 or digital input

Set the recording source for the stereo track on REC page of the MENU screen. (See “Stereo track recording settings” on page 25.)

Setting the input sources

Use the **INPUT** switches on the top panel to set the type of input for each track to either mic or line.

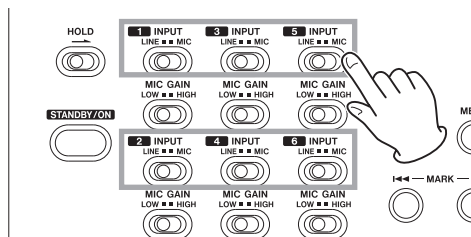

LINE: Set the switch to **LINE** when the line output jack of an external device is connected to the analog input on this unit.

MIC: Set this switch to **MIC** when a microphone is connected to this unit.

Phantom power

This unit can supply +48 V phantom power to condenser microphones.

Use the **PHANTOM** switches on the top panel to turn the phantom power supply ON or OFF for mic input pairs 1/2, 3/4 and 5/6.

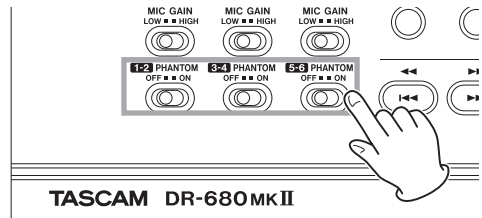

CAUTION

- Phantom power is also supplied to the TRS pins of the MIC/LINE INPUTS Jack. If you connect a line level device while phantom power is being supplied, that device and this unit could be damaged.
- Confirm that phantom power is OFF before connecting a line level device to a MIC/LINE INPUTS jack. If you connect a line level device while phantom power is being supplied, that device and this unit could be damaged.
- Do not connect or disconnect mics when a PHANTOM switch is set to ON. Doing so could cause a loud noise and might damage this unit and connected equipment.
- Set the PHANTOM switch to ON only when using a condenser microphone that requires phantom power. Turning phantom power on when a dynamic mic or other mic that does not require it is connected could damage this unit and connected equipment.
- When using condenser mics that require phantom power and dynamic mics together, be sure to use balanced dynamic mics. Unbalanced dynamic mics cannot be used when phantom power is enabled.
- Supplying phantom power to some ribbon mics will break them. If you are unsure, do not supply phantom power to a ribbon mic.

Selecting the inputs for recording to tracks 5 and 6

Tracks 5 and 6 can be used to record either analog mic/line inputs or the digital input.

1. Press the **MENU** button to open the I/O page of the MENU screen.
2. Use the **DATA** wheel to select the **INPUT 5/6** item, and press the **ENTER/MARK** button.

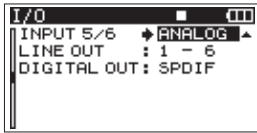

3. Use the **DATA** wheel to select **ANALOG** (default value) or **DIGITAL**.

ANALOG : Record the signals of analog inputs 5 and 6 to tracks 5 and 6.

DIGITAL : Record the digital input signal to tracks 5 and 6.

NOTE

If the **ST REC** item is set to **DIN**, this setting has no effect. The unit will operate as though set to **ANALOG**.

or during playback. It cannot be turned ON/OFF when record standby is caused by use of the Auto Rec function or record standby is enabled during recording.

3. If a mic is connected, set the **MIC GAIN** switch for that input to **LOW**.

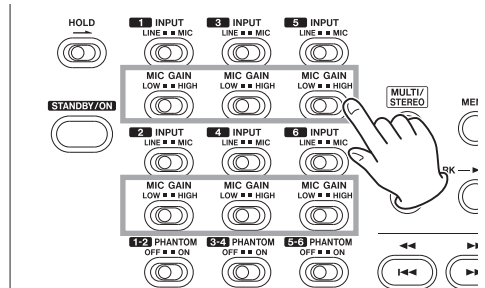

NOTE

If an **INPUT** switch is set to **LINE**, the corresponding **MIC GAIN** switch is disabled.

4. Press the **REC TRIM** button to open the **TRIM** screen.

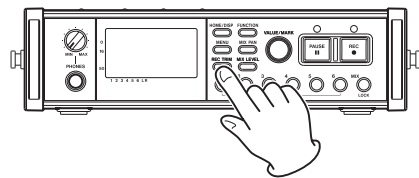

Adjusting the input levels

1. Press the **PAUSE** button to enable recording standby. The **PAUSE** and **REC** indicators light.

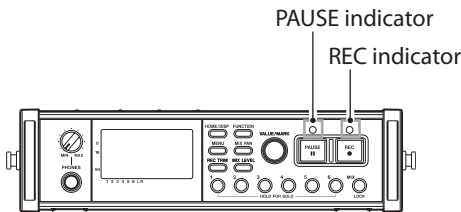

2. Use the channel number (1-6) and **MIX [LOCK]** buttons to turn the record function ON for tracks that you want to record. When the record function is ON for a track, an ● appears under its meter on the display.

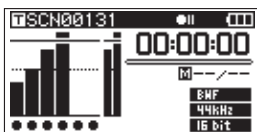

NOTE

Multiple channels can be linked and controlled at the same time. (See "GANG function" on page 48.)

NOTE

- If the file recording mode is set to **STEREO**, the record function is turned ON and OFF for channels in pairs. If the file recording mode is set to **6ch**, the record function cannot be turned ON and OFF for individual channels.
- The record function can only be turned ON/OFF when record standby is enabled when the unit is stopped

4 – Recording

- Use the **VALUE/MARK** knob to adjust the input levels in a range of ± 32 dB (default value: 0).

CAUTION

When recording with microphones, please pay attention to the following points.

- Adjust the input level so that distortion does not occur at the input stage. If distortion does occur at the input stage, the channel number to the left of the meter on the TRIM screen is shown as a light number on a dark background. In this case, the unit might record distorted sound even if the overload indicator for the meter has not appeared.

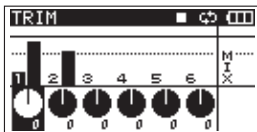

- When adjusting the input level, at first, set the MIC GAIN switch to **LOW** and adjust the input level on the TRIM screen. If the input level is still too low even when the trim is set to maximum, set the MIC GAIN switch to **HIGH**.

TIP

- In addition to using the TRIM screen to adjust the recording levels, try changing the orientation of the microphones and their distances from the sources of the sound. The orientation and distance of a microphone also changes the sound quality.
 - You can use the limiter function to prevent distortion when recording even when loud sounds are input. (See "Using the limiter" on page 34.)
- Press the **REC TRIM** or **HOME/DISP** button to return to the Home Screen.

- Press the **REC** button to start recording. During recording, the **REC** indicator lights, and the elapsed recording time or remaining recordable time appear on the display.

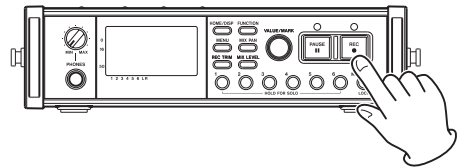

NOTE

You can also start recording by pressing the **REC** button first without pushing the **PAUSE** button beforehand.

- Press the **STOP** button to stop recording.

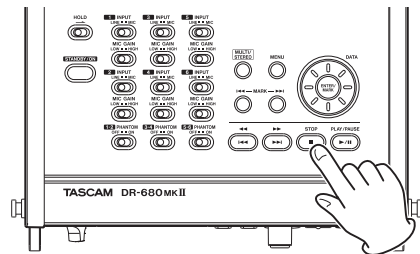

Press the **PAUSE** button to pause recording. When paused, you can press the **REC** button again to restart recording.

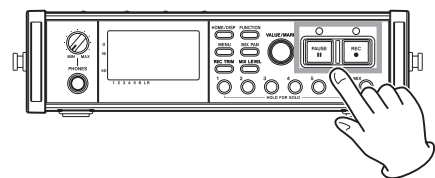

NOTE

You can set whether recording continues in the same take or a new take is created when you start recording again after pausing. (See "Creation of new takes when restarting recording" on page 26.)

Recording a take

Before starting the following procedures, input selection and level adjustment for each track should be completed, and the Home Screen should be open.

- Press the **PAUSE** button to start recording standby. The **PAUSE** and **REC** indicators light.

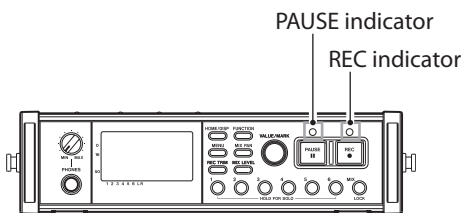

Recording a stereo mix

With this unit, in addition to recording up to 6 discrete tracks from the 6 inputs, these inputs can also be mixed internally and recorded as a stereo track.

Before starting the following procedures, input selection and level adjustment for each track should be completed, and the Home Screen should be open.

1. Press the **MIX LEVEL** button to open the **LEVEL** screen.

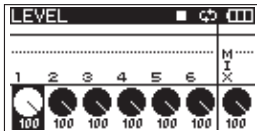

2. On this screen you can adjust the mix levels of each input channel and the recording level of the stereo track. Use the channel number (1–6) and **MIX [LOCK]** buttons to select the channels that you want to adjust.

NOTE

Multiple channels can be linked and controlled at the same time. (See “GANG function” on page 48.)

3. Use the **VALUE/MARK** knob to adjust each to a suitable recording level in a range from 0–100 (default value: 100).

NOTE

Adjust the levels so that overload indicators do not appear at the tops of the meters.

4. Next, press the **MIX PAN** button to open the **PAN** screen.

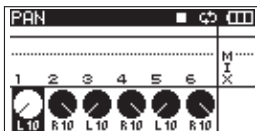

5. On this screen you can adjust the pan (stereo position) of each channel. Use the channel number (1–6) buttons to select the channel that you want to adjust.

NOTE

Multiple channels can be linked and controlled at the same time. (See “GANG function” on page 48.)

6. Use the **VALUE/MARK** knob to adjust each to a suitable stereo position using values ranging from L10–L1 (left) to C (center) and R1–R10 (right). (Odd number channels are set to L10 and even number channels are set to R10 by default.)

NOTE

Adjust the pan settings of the channels so that the mix is balanced as desired. You can check the balance with the MIX meters at the far right.

7. When you have finished making the settings, press the **HOME/DISP** button to return to the Home Screen.

Simultaneously recording two files at different input levels (DUAL REC)

This recorder can simultaneously record a second recording at a different input level along with the regular recording. For example, when recording with microphones, you can make an ordinary recording with the input level set as high as possible and simultaneously record at a –12 dB lower input level for security.

Two recorded takes will be saved: one at the ordinary recording input level and another with a –12dB input level.

MIC/LINE INPUTS 1/3/5 are the three input jacks that can be used for dual recording with this unit.

The audio recorded at the ordinary level will use mixer channels 1/3/5 and be recorded to tracks 1/3/5.

The audio recorded at the reduced level will use mixer channels 2/4/6 and be recorded to tracks 1/3/5 of a different take.

NOTE

- Files recorded when Dual Rec mode is selected will be Mono files.
- Make the input level setting for the ordinary recording in the usual manner. (See “Adjusting the input levels” on page 29.)

Enabling dual recording

1. Press the **MENU** button to open the **REC** page of the **MENU** screen.
2. Use the **DATA** wheel to select the **DUAL REC** item, and press the **ENTER/MARK** button.



3. Use the **DATA** wheel to select one of the following settings.

Options: OFF, ON (default)

4. Press the **MARK** (◀◀) button to return to item selection on the **MENU** screen.
5. Press the **HOME/DISP** button to return to the Home Screen.

NOTE

- Stereo file and 6ch file modes cannot be selected.
- MS mode will be canceled.
- GANG settings will be canceled.
- When recording starts, soloing of channels 2/4/6 will be canceled.

4 – Recording

Starting dual recording

Press the **REC** button to start dual recording.

When dual recording, "D" will appear for the dual channels (2/4/6) on the Home Screen.



Dual recording take names

Dual recording will create two files simultaneously.

The name of the second take created by dual recording has D added to the take name of the ordinary recording.

SCN0127_001

① ②

SCN0127_001_D

① ② ③

- ①: Set by the **NAME** item on the **REC** menu page
- ②: Basic recording file number
- ③: D added to dual recording take

Using the solo function

Press and hold one of the channel number (1–6) buttons on the front panel to enable solo monitoring for that channel.

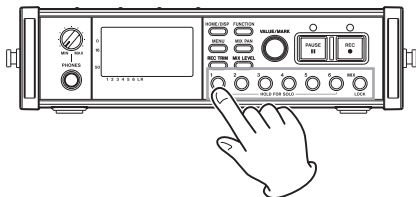

When solo monitoring, the **SOLO** indicator appears on the Home Screen, and the **S** indicator appears for the soloed channel.

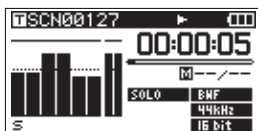

To turn solo monitoring off, press and hold the corresponding channel number (1–6) button again.

NOTE

Solo monitoring is only possible using the headphones and built-in speaker.

Automatically starting and pausing recording (auto-record function)

If you turn the auto-record function ON, you can automatically start, stop and pause recording in response to the level of the input sound.

If an input level greater than the level set in advance is detected on any input channel, recording starts.

In addition, the unit can automatically cut silent parts and add marks at points where recording starts again.

NOTE

The levels of input on all channels must remain below the set level for at least one second before the auto-record function is activated.

Using the auto-record function

- When the Home Screen is open, press the **FUNCTION** button to open the Functions Screen.
- Use the **VALUE/MARK** knob to move the cursor and select the **A.REC** item.
- Press the **VALUE/MARK** knob to turn auto-recording ON or OFF.

If auto-recording has been turned ON, the **A.REC** indicator appears with a dark background.

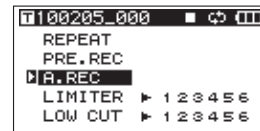

- When you have finished making the settings, press the **HOME/DISP** button to return to the Home Screen.

Auto-record settings

- Press the **MENU** button to open the **AUTO REC** page of the **MENU** screen.
- Use the **DATA** wheel to select the **LEVEL** item, and press the **ENTER/MARK** button.

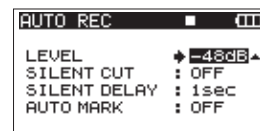

- Set the level at which the unit determines that a signal is being input for starting and stopping automatic recording. Use the **DATA** wheel to set the value to -6dB, -12dB (default value), -24dB, or -48dB.
- When you have finished making the settings, press the **HOME/DISP** button to return to the Home Screen.
- Press the **PAUSE** button to enter recording standby. When the input sound exceeds the level set by the **LEVEL** item, the unit automatically starts recording.

Automatically cutting unnecessary silences when recording (silent cut function)

When recording, the unit can pause when it detects silence for a certain amount of time, and then restart recording when it detects an input signal again. Since this cuts unnecessary silence during recording, space on the card can be conserved.

1. Set the **A.REC** item on the Function Screen and the **LEVEL** item on the **AUTO REC** menu page as described above.
2. Use the **DATA** wheel to select the **SILENT CUT** item, and press the **ENTER/MARK** button.
3. Use the **DATA** wheel to set it to **ON** (default value: **OFF**).

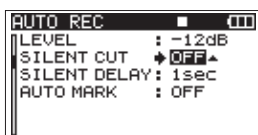

4. Press the **MARK** (**◀◀**) button to return to selecting items.
5. Use the **DATA** wheel to select the **SILENT DELAY** item, and press the **MARK** (**▶▶**) button.

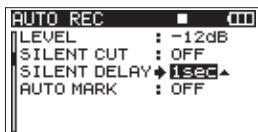

6. Use the **DATA** wheel to set the silence that must be detected before recording is paused between 1–5 seconds (default value: 1 seconds).
7. When you have finished making the settings, press the **HOME/DISP** button to return to the Home Screen.
8. Press the **PAUSE** button to start recording standby.

When the input sound exceeds the level set in the **LEVEL** item, recording starts automatically.

When the input sound level is below the level set in the **LEVEL** item for a set number of seconds, recording automatically pauses.

When the input sound exceeds the level set in the **LEVEL** item again, recording restarts automatically.

Automatically adding marks at the position where recording restarts

You can set whether a mark is added or a new take is created whenever input higher than the set auto rec level is detected after the input level has been below the auto rec level for one second or more.

1. Set the **A.REC** item on the Function Screen and the **LEVEL** item on the **AUTO REC** menu page as described above.
2. Use the **DATA** wheel to select the **AUTO MARK** item, and press the **ENTER/MARK** button.
3. Use the **DATA** wheel to set it to **MARK** or **TAKE**.

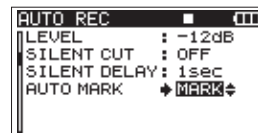

OFF (default): Auto mark function off

MARK: After the input level has been below the set auto rec level for one second or more, when input higher than the auto rec level is detected again, a mark is added at that position. Recording continues in the same take.

TAKE: After the input level has been below the set auto rec level for one second or more, when input higher than the auto rec level is detected again, recording continues in a new take. After pausing because of activation of the silent cut function, recording restarts in a new take.

4. When you have finished making the settings, press the **HOME/DISP** button to return to the Home Screen.
5. Press the **PAUSE** button to start recording standby. Depending on the setting, a mark is added or a new take is created when recording starts automatically.

4 – Recording

Track incrementation

With this unit, the maximum recording file size is 2 GB. If the file size reaches 2 GB while recording, the unit automatically continues recording in a new take and stops recording the current take.

Manually incrementing tracks during recording

You can manually create a new take during recording at any time.

Press the **REC** button during recording to create a new take and continue recording.

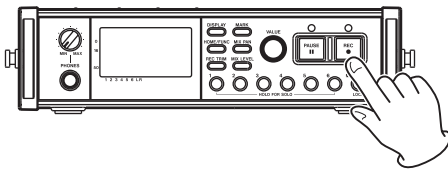

NOTE

- When a new take is created, the number at the end of the take name is increased by one.
- You should use a folder that contains as few takes as possible when creating new takes while recording or when expecting to do so.
- The maximum number of takes in a folder is about 100.

CAUTION

- If the total number of folders and files would exceed 5000, a new take cannot be created.
- If the total number of takes would exceed 1000, a new take cannot be created.
- A new take cannot be created if the recording time is less than 4 seconds.
- If the newly created take would have the same name as an existing take, the numerical suffix is increased by one as many times as necessary until a unique name is created.

Automatically incrementing tracks by file size

When recording, if the size of the file reaches one of the limits listed below, the unit stops recording the current take and starts recording in a new take without interrupting the recording.

WAV/BWF: When the file size reaches 2 GB

MP3: When the file size reaches 2 GB or the recording time reaches 24 hours

CAUTION

- If the total number of folders and files would exceed 5000, a new take cannot be created.
- If the total number of takes would exceed 1000, a new take cannot be created.

NOTE

Recording times are different for the same file size depending on the file format and recording mode.

Using the limiter

Turn the limiter function ON to make the unit automatically adjust the input level to prevent distortion if the input level is too loud.

1. When the Home Screen is open, press the **FUNCTION** button to open the Functions Screen.
2. Use the **VALUE/MARK** knob to move the cursor and select the **LIMITER** menu item.
3. Press the **VALUE/MARK** knob.
4. Press the **VALUE/MARK** knob to turn the limiter ON or OFF for all inputs at the same time (default: all channels off).

Press the channel number (1–6) buttons to turn the limiter ON or OFF for each input independently.

If the limiter has been turned ON for one or more inputs, the **LIMITER** indicator appears with a dark background.



5. When you have finished making the settings, press the **HOME/DISP** button to return to the Home Screen.

Using the low-cut filter

Use the low-cut filter to reduce low-frequency noise. Set the cut-off frequency to 40 Hz, 80 Hz or 120 Hz according to the recording conditions.

Turning the low-cut filter on and off

1. When the Home Screen is open, press the **FUNCTION** button to open the Functions Screen.
2. Use the **VALUE/MARK** knob to move the cursor and select the **LOW CUT** menu item.
3. Press the **VALUE/MARK** knob.
4. Press the **VALUE/MARK** knob to turn the low-cut filter ON or OFF for all inputs at the same time (default: all channels off).

Press the channel number (**1–6**) buttons to turn the low-cut filter ON or OFF for each input independently.

If the low-cut filter has been turned ON for one or more inputs, the **LOW CUT** indicator appears with a dark background.

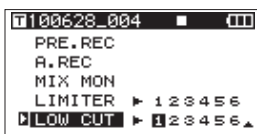

5. When you have finished making the settings, press the **HOME/DISP** button to return to the Home Screen.

Setting the cut-off frequency of the low-cut filter

1. Press the **MENU** button to open the **LOW CUT** page of the **MENU** screen.
2. Use the **DATA** wheel to set the cut-off frequency to 40 Hz, 80 Hz (default value) or 120 Hz.

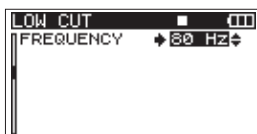

3. When you have finished making the settings, press the **HOME/DISP** button to return to the Home Screen.

Using marks

Manually adding marks when recording and during playback

Press the **VALUE/MARK** knob or **ENTER/MARK** button when recording and during playback to add a mark at a desired position.

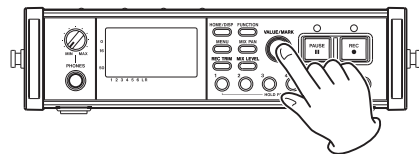

The mark number is shown when you do this.

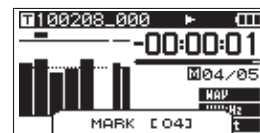

NOTE

- When a recording is paused and then restarted, a mark is added at that point. Marks are numbered in each take from 01–99, and the mark data is saved with each take.
- If you add a mark during playback, the mark is not immediately saved in the file, but rather is saved when playback stops. If you change the take using the **◀◀** [**◀◀**] or **▶▶** [**▶▶**] button without stopping, the addition of mark is not completed.

Moving to a mark

When stopped or during playback, use the **MARK** (**◀◀**/**▶▶**) buttons to move to the positions of marks added to the current state.

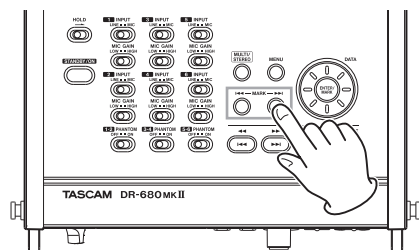

You can use these marks to index places where you might want to resume playback.

NOTE

You cannot move to a mark in a different take.

4 – Recording

Erasing marks

Press the **ENTER/MARK** button on the top of the unit to delete a mark added at the current position.

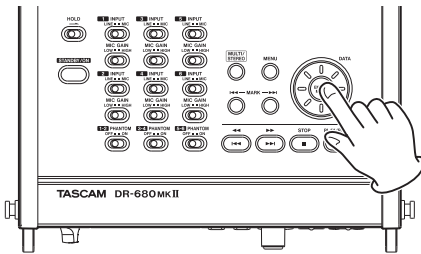

NOTE

If you erase a mark during playback, the mark is not immediately erased, but rather is erased when playback stops. If you change the take using the [◀◀] or ▶▶ [▶▶] button without stopping, the erasure of marks is not completed.

Pre-recording

When the unit is in recording standby, the unit can record up to two seconds before the start of recording and include it in the recording.

1. When the Home Screen is open, press the **FUNCTION** button to open the Functions Screen.
2. Use the **VALUE/MARK** knob to move the cursor and select the **PRE.REC** menu item.
3. Press the **VALUE/MARK** knob to turn pre-recording ON or OFF.

If pre-recording has been turned ON, the **PRE.REC** indicator appears with a dark background.



4. When you have finished making the settings, press the **HOME/DISP** button to return to the Home Screen.

TIP

Used in combination with the auto-record function, you can capture recordings without losing the initial sound.

NOTE

If the unit has been in recording standby for less than two seconds, only the amount of time that the unit has been in standby can be recorded.

Recording times

Recording times (in hours and minutes) for different file formats and SD/SDHC/SDXC card capacities are shown in the following table.

WAV/BWF			SD/SDHC/SDXC card capacity						
Sampling frequency (kHz)	Bit length	Number of tracks	2	4	8	16	32	64	128
44.1	16	6	1:02	2:05	4:11	8:23	16:47	33:35	67:11
		8	0:47	1:34	3:08	6:17	12:35	25:11	50:23
	24	6	0:42	1:23	2:47	5:35	11:11	22:23	44:47
		8	0:31	1:02	2:05	4:11	8:23	16:47	33:35
48	16	6	0:57	1:55	3:51	7:42	15:25	30:51	61:43
		8	0:43	1:26	2:53	5:47	11:34	23:08	46:17
	24	6	0:38	1:17	2:34	5:08	10:17	20:34	41:09
		8	0:28	0:57	1:55	3:51	7:42	15:25	30:51
96	16	6	0:28	0:57	1:55	3:51	7:42	15:25	30:51
		8	0:21	0:43	1:26	2:53	5:47	11:34	23:08
	24	6	0:19	0:38	1:17	2:34	5:08	10:17	20:34
		8	0:14	0:28	0:57	1:55	3:51	7:42	15:25
192	16	2	0:43	1:26	2:53	5:47	11:34	23:08	46:17
	24	2	0:28	0:57	1:55	3:51	7:42	15:25	30:51

MP3			SD/SDHC/SDXC card capacity						
	Bitrate (kbps)	Number of tracks	2	4	8	16	32	64	128
	96	4	23:08	46:17	92:35	185:00	370:00	740:00	1481:00
	128		17:21	34:43	69:26	138:00	277:00	555:00	1111:00
	192		11:34	23:08	46:17	92:35	185:00	370:00	740:00
	320		6:56	13:53	27:46	55:33	111:00	222:00	444:00

- The above recording times are estimates, and might differ according to the SD/SDHC/SDXC card.
- The above recording times are not continuous recording times. They are total recording times for SD/SDHC/SDXC card capacities.

5 – Take and folder operations (BROWSE screen)

On the **BROWSE** screen, you can view the contents of the **MUSIC** Folder (take storage folder), which is where take files are stored on the SD card.

To open the **BROWSE** screen, press the **MENU** button on the top of the unit and open the **GENERAL** menu page. Then, use the **DATA** wheel to select (highlight) **BROWSE**, and press the **ENTER/MARK** button.

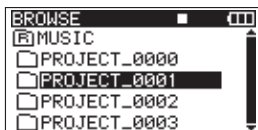

The contents of the folder that contains the take that was selected on the Home Screen before the **BROWSE** screen was opened appears on the display.

Navigating the BROWSE screen

On the **BROWSE** screen, folders and takes appear in a hierarchical structure much like they would appear on a computer. On this unit, only one level of folders can be created.

- Use the **DATA** wheel to select takes and folders.
- When a folder is selected, press the **MARK** (**▶▶**) button to show the contents of that folder.
- When a taker folder is selected, press the **MARK** (**◀◀**) button to close the currently open folder and show the higher-level folder that contains it.
- When a folder or take is selected, press the **ENTER/MARK** button to open the pop-up menu.

Icons on the BROWSE screen

The meanings of the icons that appear on the **BROWSE** screen are as follows.

MUSIC folder (MUSIC)

The **MUSIC** folder is the highest-level folder (root folder) shown on the **BROWSE** screen.

Take (🎵)

This icon appears before the name of a recorded take.

Folder (📁)

This icon shows a folder.

Open folder (📂)

The contents of this folder are currently shown on the screen.

Take operations

Select the desired take on the **BROWSE** screen and press the **ENTER/MARK** button to open the pop-up window that is shown below.

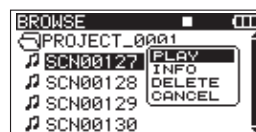

Use the **DATA** wheel to select the desired item from the following options, and press the **ENTER/MARK** button to execute it.

PLAY

Choose this to select the take, return to the Home Screen and start playback of that take. If the playback area is set to **FOLDER**, the folder that contains this take becomes the playback area.

INFO

This shows information about the selected take.



Press the **ENTER/MARK** or **MARK** (**◀◀**) button again to return to the **BROWSE** screen.

DELETE

If you choose this, a pop-up message appears to confirm that you want to delete the take. Press the **ENTER/MARK** button to erase the take and return to the **BROWSE** screen.

Press the **MARK** (**◀◀**) button to cancel deletion and reopen the pop-up menu.



CANCEL

Press this to not conduct any operation on the selected take.

5 – Take and folder operations (BROWSE screen)

Folder operations

Select the desired folder on the **BROWSE** screen, and press the **ENTER/MARK** button to open the following pop-up menu.

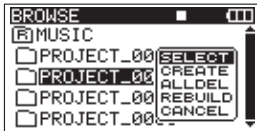

Use the **DATA** wheel to select the desired item from the following options, and press the **ENTER/MARK** button to execute it.

SELECT

Returns to the Home Screen and selects the first take in the folder. This folder becomes the new playback area regardless of the previous playback area setting. New recorded takes are saved in this folder.

CREATE

A pop-up appears to confirm that you want to create a new folder.



Press the **ENTER/MARK** button to create a new folder. New recorded takes are saved in this folder.

Press the **MARK** (**I◀◀**) button to cancel folder creation and reopen the pop-up menu.

ALLDEL

A pop-up appears to confirm that you want to delete all the takes in the selected folder at once.

Press the **ENTER/MARK** button to erase the takes and return to the **BROWSE** screen. Press the **MARK** (**I◀◀**) button to cancel deletion and reopen the pop-up menu.



NOTE

This unit cannot delete write-protected files and files that the unit does not recognize.

REBUILD

A pop-up appears to confirm that you want to rebuild the selected folder.

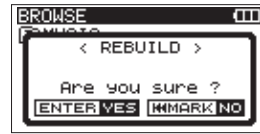

Rebuilding refreshes the take information inside the selected folder, and recognizes files that are not contained in takes as independent takes, making their playback possible. Use this function after you have copied files to the SD card from a computer, for example.

Press the **ENTER/MARK** button to rebuild the folder and return to the **BROWSE** screen.

Press the **MARK** (**I◀◀**) button to cancel rebuilding and reopen the pop-up menu.

Moreover, if file names have been added according to the following rules, multiple files will automatically be registered as a single take. However, this does not mean that their formats (WAV/BWF or MP3), sampling frequencies, bit depths (for WAV/BWF files), bit rates (for MP3 files), file types (mono or stereo) and file sizes will all be the same.

■ File naming rules (WAV/BWF example)

- Mono file

XXXX_ monoY.wav
① ② ③

- Stereo file

XXXX_ stY.wav
① ② ③

- ①: Take name part (no more than 10 half-width alphanumeric characters)
- ②: File type (mono or stereo)
- ③: Track number (1 to 6 for mono, 12, 34 or 56 for stereo)

NOTE

- *Files with formats that are not supported by this unit will not be recognized even after rebuilding and cannot be played back.*
- *Files with names using characters other than half-width alphanumeric characters cannot be rebuilt.*

CANCEL

Press this to not conduct any operation on the selected folder.

6 – Playback

When the Home Screen is open, use the ◀◀ [I◀◀] and ▶▶ [▶▶I] buttons to select the take that you want to play. You can only select takes within the playback area that is currently set. When there are lots of takes on a card, for example, setting the play area to a limited number of takes can make selection easier.

On the **PLAY** page, you can set the playback area to all takes, the current folder or the currently loaded take.

You can also set a folder for playback on the **BROWSE** screen.

NOTE

*On the **BROWSE** screen, regardless of the current playback area setting, you can select and play any take on the card.*

Playback

Starting playback

On the Home Screen, when the unit is stopped, press the **PLAY/PAUSE** button to start playback.

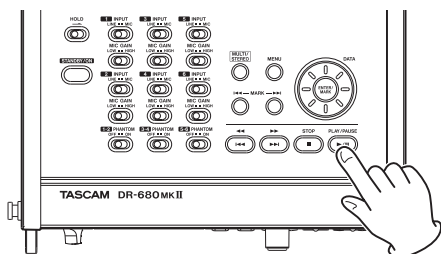

NOTE

- Only takes in the playback area can be played. (See "Setting the playback area" on page 42.)
- You can also start playback by selecting a take on the **BROWSE** screen.

Stopping playback

On the Home Screen, press the **STOP** button during playback to stop playing a take and return to its beginning.

Pausing playback

On the Home Screen, press the **PLAY/PAUSE** button during playback to pause playback at the current position in the take.

Press the **PLAY/PAUSE** button again to restart playback from that position.

Searching forward and backward

On the Home Screen, when stopped or during playback, press and hold the ◀◀ [I◀◀] button or ▶▶ [▶▶I] button to search backward or forward.

Selecting a take for playback

On the Home Screen, use the ◀◀ [I◀◀] button or ▶▶ [▶▶I] button to select a take for playback.

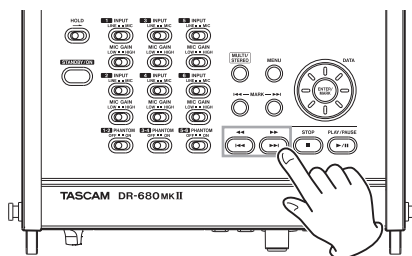

When in the middle of a take, press the ◀◀ [I◀◀] button to return to the beginning of that take.

When stopped at the beginning of a take, press the ◀◀ [I◀◀] button to skip to the beginning of the previous take.

When at the beginning of or in the middle of a take, press the ▶▶ [▶▶I] button to skip to the beginning of the next take.

NOTE

- Only takes in the playback area can be played.
- Information about the take being played, including the name, is shown.

Changing the playback position (scrubbing)

On the Home Screen, when stopped or during playback, use the **DATA** wheel to change the playback position.

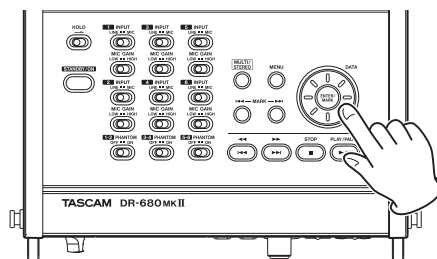

NOTE

- No sound is output while you are turning the **DATA** wheel.
- If you turn the **DATA** wheel during playback, playback restarts at the position located when you stop turning the **DATA** wheel.

Mixing and outputting a multitrack recording

When playing back the sound of a multitrack recording, you can use the unit's internal mixer to make a stereo mix and then output that.

Adjust the playback sound of tracks 1–6 using mixer channels 1–6. You can also adjust the overall level of the mix.

You can output the stereo mix that you have mixed using the internal mixer to the **PHONE** and **DIGITAL/SYNC OUT** jacks.

In addition, if the I/O page **LINE OUT** item is set to **MIX**, a stereo mix can be output from the **LINE OUTPUTS** jacks. When set this way, the sound of the left (L) channel is output through **LINE OUTPUTS 1, 3 and 5** and the sound of the right (R) channel is output through **LINE OUTPUTS 2, 4 and 6**.

Using the internal mixer

1. Press the **MIX LEVEL** button to open the **LEVEL** screen.

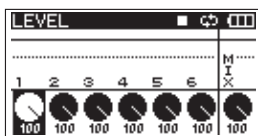

2. Adjust the levels of channels 1–6 and the overall mix on this screen. Use the channel number (1–6) and **MIX [LOCK]** buttons to select the channels that you want to adjust.
3. Use the **VALUE/MARK** knob to adjust the optimal level in a range between 0 and 100 (default value is 100).
4. Press the **MIX PAN** button to open the **PAN** screen.

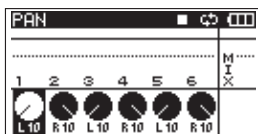

5. Use the pan controls on this screen to adjust the stereo position of each channel. Use the channel number (1–6) buttons to select the channels that you want to adjust.

NOTE

Multiple channels can be linked and controlled at the same time. (See "GANG function" on page 48.)

6. Use the **VALUE/MARK** knob to adjust each to a suitable stereo position using values ranging from L10–L1 (left) to C (center) and R1–R10 (right). (Odd number channels are set to L10 and even number channels are set to R10 by default.)

7. When you have finished making the settings, press the **HOME/DISP** button to return to the Home Screen.

NOTE

This function cannot be used when playing a stereo track.

Using the solo function

Press and hold one of the channel number (1–6) buttons on the front panel to enable solo monitoring for that channel.

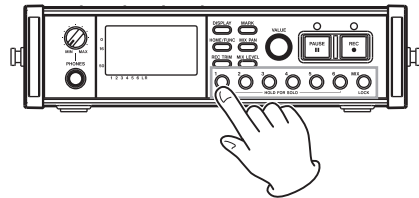

When solo monitoring, the **SOLO** indicator appears on the Home Screen, and the **S** indicator appears for the soloed channel.

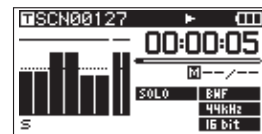

To turn solo monitoring off, press and hold the corresponding channel number (1–6) button again.

NOTE

Solo monitoring can only be used with headphones and the built-in speaker.

Playing a stereo track

In addition to multitrack recording, this unit can also record a stereo track simultaneously. For example, a 6-track multitrack and a stereo track can be recorded at the same time.

During playback, press the **MULTI/STEREO** button to switch between the multitrack and the stereo track

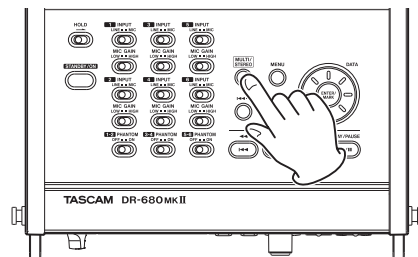

During playback of the stereo track, the **STEREO** icon appears on the Home Screen.

6 – Playback

Setting the playback area

1. Press the **MENU** button to open the **PLAY** page of the **MENU** screen.
2. Use the **DATA** wheel to select the **AREA** item, and press the **MARK** (▶▶) button or **ENTER/MARK** button.



3. Use the **DATA** wheel to set the playback area.
SINGLE: Play only the selected take.
FOLDER (default value): Play all the takes in the currently selected folder on the **BROWSE** screen.
ALL: Play all takes in the **MUSIC** Folder on the **SD** card.
4. When you have finished making the settings, press the **HOME/DISP** button to return to the Home Screen.

Selecting a folder for the playback area on the BROWSE screen

Regardless of the current playback area, if you play a take on the **BROWSE** screen, the playback area changes to the folder that contains that take.

1. Press the **MENU** button to open the **GENERAL** page of the **MENU** screen.
2. Use the **DATA** wheel to select the **BROWSE** menu item, and press the **ENTER/MARK** button to open the **BROWSE** screen.
3. Use the **DATA** wheel to select the folder that contains the take that you want to play.

NOTE

For additional information about how to navigate the **BROWSE** screen, see “Navigating the **BROWSE** screen” on page 38.

4. Press the **MARK** (▶▶) button.
5. Select the take that you want to play.
6. Press the **ENTER/MARK** button to open the following pop-up menu.

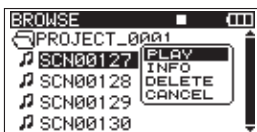

Use the **DATA** wheel to choose **PLAY** and press the **ENTER/MARK** button to return to the Home Screen. The selected take begins to play. If the playback area is set to **FOLDER**, the folder that contains that take becomes the playback area.

Setting the search speed

1. Press the **MENU** button to open the **PLAY** page of the **MENU** screen.
2. Use the **DATA** wheel to select the **SEARCH SPEED** item, and press the **ENTER/MARK** button.

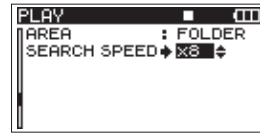

3. Use the **DATA** wheel to set the search speed to **x2**, **x4**, **x8** (default value) or **x10**.
4. When you have finished making the settings, press the **HOME/DISP** button to return to the Home Screen.

Repeat playback

You can set the unit to repeatedly play a single take or all takes in a folder.

1. When the Home Screen is open, press the **FUNCTION** button to open the **Functions** Screen.
2. Use the **VALUE/MARK** knob to move the cursor and select the **REPEAT** menu item.
3. Press the **VALUE/MARK** knob to turn the repeat playback **ON** or **OFF**.
If the repeat has been turned **ON**, the **REPEAT** indicator appears with a dark background.

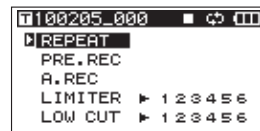

4. When you have finished making the settings, press the **HOME/DISP** button to return to the Home Screen.

NOTE

- The  icon appears on the Home Screen when the repeat function is **ON**.
- The takes in the currently set playback area are repeated. (See “Setting the playback area” on page 42.)

7 – Connection with a computer

By connecting this unit with a computer using the included USB cable, you can copy audio files between the SD card in the unit and the computer.

This unit can handle MP3 (96, 128, 192, 320 kbps, 44.1 k/48 kHz) and WAV/BWF (44.1 k/48 k/96 k/192 kHz, 16/24-bit) audio files.

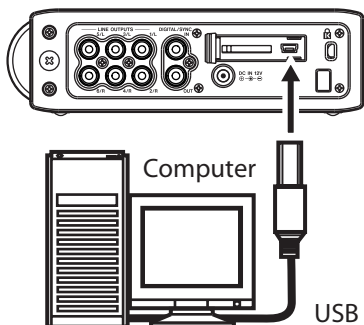

NOTE

Instead of connecting this unit to a computer by USB, you can also perform the same operations by removing the SD card and connecting it directly to a computer using a card reader, for example.

Confirm that an SD card is inserted correctly into the unit. If an SD card is not inserted correctly when the unit is connected to a computer by USB, a Can't Save Data pop-up message appears.

When connected, USB connected appears on the display of this unit.



NOTE

Other unit functions cannot be used when it is connected to a computer by USB.

This unit appears on the computer as an external drive named "DR-680MK2".

On Windows, open "My computer" to show the "DR-680MK2" drive.

On Mac OS X, the "DR-680MK2" drive should appear on the desktop or in the Finder sidebar, depending on the system settings.

Click on the "DR-680MK2" drive to show the "MUSIC" and "UTILITY" folders.

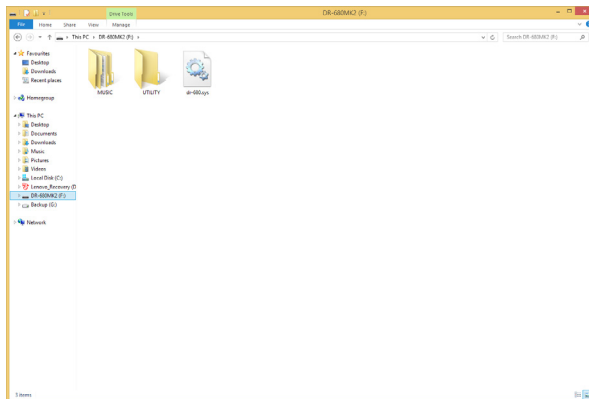

Copying files to a computer

Open the "MUSIC" folder, and drag-and-drop the files that you want to copy to any location on the computer.

7 – Connection with a computer

Copying files from a computer

Drag and drop files from anywhere on the computer to folders that you create as desired in the “MUSIC” folder.

After you have copied files to an SD card and disconnected from the computer, on the **BROWSE** screen, select the folder that you copied the files into and execute the **REBUILD** operation. (See “REBUILD” on page 39.)

Rebuilding the folder makes it possible for this unit to play the copied files.

Before rebuilding, make sure the file and folder names contain only single-byte alphanumeric characters.

NOTE

- *If you use a computer to change the name of a file or folder created by this unit, the unit will not recognize the affected files as takes. Avoid changing names on a computer if you want to use them again on this unit.*
- *Files with formats that are not supported by this unit will not be recognized even after rebuilding and cannot be played back.*

TIP

- *You can also use the computer to manage the contents of the “MUSIC” folder.*
- *You can create subfolders inside the “MUSIC” folder, but this unit can only recognize one level of subfolders. The unit ignores deeper folder levels and the files in them.*
- *Since this unit can be set to play the contents of a single folder, organizing folders by musical category or artist could be convenient.*
- *This unit can only read files and folders with names that contain only single-byte alphanumeric characters.*
- *Names given to subfolders and files are shown on the unit’s Home Screen and the **BROWSE** screen.*
- *Folders created directly inside the “MUSIC” folder using a computer can be given names with 16 or more characters without interfering with the operation of the unit, but only the first 15 characters will be shown on its display.*

Ending the connection with a computer

Follow the correct computer procedures to disconnect the unit from the computer before disconnecting the USB cable. Please refer to your computer manual for information about the correct procedures for disconnecting an external drive.

After being disconnected, the power is set to standby.

8 – Cascade function

Preparing to use the cascade function

1. Connect the **DIGITAL/SYNC OUT** jack of the master unit to the **DIGITAL SYNC IN** jack of the slave unit using a commercially-available coaxial digital cable.

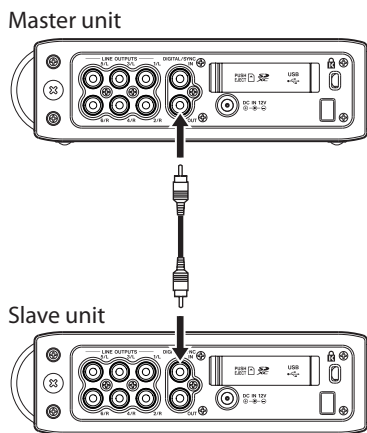

2. Make the following settings using the menus of both master and slave units.

■ REC page

- **FORMAT:**
We recommend that you use the same setting for both the master and slave units.
- **SAMPLE:**
We recommend that you use the same setting for both the master and slave units.
- **PAUSE:**
This must be set to the same value on both the master and slave units.

■ PLAY page

- **AREA:**
For cascade playback, both the master and slave units must be set the same.

■ SYSTEM page

- **CASCADE:**
Set the master unit to **MASTER** and the slave unit to **SLAVE**.

■ Function screen

- **REPEAT:**
For cascade playback, both the master and slave units must be set the same.
- **PRE.REC:**
Set both the master and slave units to the same value.

3. Press the **HOME** buttons on both the master and slave units to open their Home Screens.
4. Press the **STOP** button on both the master and slave units to stop them.

Cascade recording

When the units are stopped, press the **REC** button to start recording with both the master and slave units.

During recording, press the **STOP** button to stop recording with both the master and slave units.

Press the **PAUSE** button to pause recording with both the master and slave units.

When paused, press the **REC** button to resume recording.

When paused, press the **PAUSE** button or the **STOP** button to stop recording.

Cascade playback

When stopped, press the **PLAY/PAUSE** button to start playback of both the master and slave units from the current position.

During playback, press the **PLAY/PAUSE** button to pause playback of both the master and slave units at the current position.

Disabling cascade operation

Set the **CASCADE** item on the **SYSTEM** page to **OFF**.

8 – Cascade function

Precautions for use of the cascade function

- When the cascade function is ON, the auto record function is disabled. If you turn the cascade function ON when the auto record function is ON, the auto record function turns OFF automatically. When the cascade function is turned OFF again, the auto record function remains OFF. To use the auto record function, turn it ON again after turning the cascade function OFF.
- When using the cascade function, set the PAUSE item of the REC menu to the same value for both the master and slave units. If the settings of the master and slave units are different, their operation after pausing recording will not be the same, and control of their transports will not occur correctly.
- If the types of cards used for recording in the master and slave units are different and the PAUSE item of the REC menu is set to NEW TAKE, recording might not start simultaneously when the REC button is operated. The reason for this is that the processing time for the units differs when the slave and master units use different types of cards. Moreover, this lag between units can also occur if the recording file format or sampling frequency settings of the master and slave units are not the same. To conduct cascade recording without lag, use the same type of card in both the master and slave units and set their recording file formats and sampling frequencies to the same values. Alternately, the lag between units can also be avoided by waiting several seconds after putting the unit in recording standby before pressing the REC button.
- The Home Screen must be open on both the master and slave units to use the cascade function. If a menu screen is open on either or both units, the cascade function will not work properly.
- Use of the cascade function for playback is intended for checking recorded takes. We cannot guarantee synchronized playback.

9 – Other Settings and Information Display

Using mid-side mic decoding

With this unit, you can connect a mid-side mic and decode the signal while recording. You can also record without decoding, but check the decoded result with the monitoring output.

NOTE

When dual recording is enabled, the mid-side mic decoding function cannot be used. (See "Enabling dual recording" on page 31.)

Connecting a mid-side microphone

When using this unit's mid-side decoding function, connect the mid signal to the odd channel and the side signal to the even channel in the pair. If you connect them in reverse, correct decoding is not possible.

For example, connect the mid signal to channel 3 and the side signal to channel 4.

Setting the MS decoding mode

Select the MS MODE item on the SYSTEM page to open the MS MODE screen.

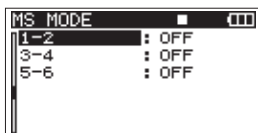

Set the decoding mode to use when connecting mid-side microphones. Channel pairs 1-2, 3-4 and 5-6 can each be set separately.

OFF (default value)

Recording and playback use the ordinary mode (no mid-side decoding).

INPUT

Use this mode to decode while recording.

Playback uses the ordinary mode.

MONITOR

Use to monitor the output of mid-side microphones with decoding while recording without decoding.

Also use this with a take that was recorded without decoding to decode it during playback. In that case, LINE OUT should be set to MIX on the I/O page.

NOTE

The MS MODE screen settings cannot be changed during recording or playback. Always stop the unit (the transport icon should be ) before changing the settings.

Recording with mid-side decoding

1. On the MS MODE screen, set the decoding mode to INPUT.
2. Press the **MIX PAN** button on the front panel to open the PAN screen (pan pot adjustment screen). Use the MS width control to adjust the width of the mid-side signal pair.

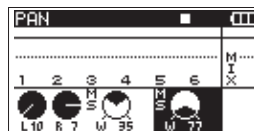

Press one of the channel number (1–6) buttons on the front panel that corresponds to one of the mid-side channels that was set to INPUT on the MS MODE screen. (For example, press 3 or 4 to adjust paired channels 3 and 4.)

Use the **VALUE/MARK** knob to adjust the width of the signal suitably in a 0–100 range. At 0, only the mid channel is included in the stereo decoding. As the value is increased, more of the side channel is included in the stereo decoding. At 100, only the side channel is included. (The default value is 0.)

3. Press the **MIX LEVEL** button on the front panel to open the LEVEL screen, and adjust the decoder output.

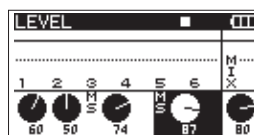

Press one of the channel number (1–6) buttons on the front panel that corresponds to one of the mid-side channels that was set to INPUT on the MS MODE screen. (For example, press 3 or 4 to adjust paired channels 3 and 4.)

Use the **VALUE/MARK** knob to adjust the signal level suitably in a 0–100 range. The lower the number is, the lower the output level becomes (default value: 100).

NOTE

- *A take that was recorded without decoding (mid and side channels recorded as is) can also be decoded during playback by setting MS MODE to MONITOR. When decoding during playback, output will be of the stereo mix.*
- *To record without decoding, set the MS MODE to OFF or MONITOR.*
- *If set to MONITOR, you can monitor the decoded signal during recording.*

9 – Other Settings and Information Display

GANG function

The GANG function allows you to adjust multiple channels at the same time on the TRIM, PAN and LEVEL screens.

Set the range of channels to be ganged by pressing the channel number (1–6) buttons for the channels at both ends of the range at the same time.

For example, to gang channels 3–5, press the 3 and 5 buttons at the same time. When you do so, channels 3–5 will appear selected on the screen as shown in the illustration below.

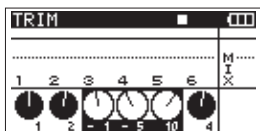

You can create multiple gangs of channels by setting each gang separately. However, no channel can be part of more than one gang.

When ganged, you can adjust parameters for the ganged channels at the same time.

If the parameter setting for any of the ganged channels reaches its maximum or minimum value, turning the VALUE/MARK knob in the same direction will not further increase or decrease the other channel parameters.

If you press and hold the VALUE/MARK knob while multiple channels are selected, the parameter values for all of the ganged channels will be set to the lowest value of the channels.

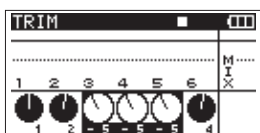

Any of the following actions will deactivate the GANG function.

- Press any button that corresponds to a channel that is currently ganged.
- Put the unit power in standby.
- Activate or Deactivate MS decoding.
- Use the INITIALIZE function.

When using the GANG function, the ganged channels are the same on the TRIM, PAN and LEVEL screens. However, channels that have been set to use mid-side decoding cannot be ganged or unganged on the PAN and LEVEL screens.

NOTE

- *You cannot gang channels that are set to use MS decoding with channels that are not. However, you can gang such channels separately.*
- *You cannot gang channels that are set to use different types of MS decoding.*
- *When designating a range that includes multiple channel pairs set to use MS decoding, only the channels in the pair with the lowest number is ganged.*

- *If only one of the channels in a pair set to use MS decoding is included in the range, none of the channels will be ganged together.*
- *When dual recording is enabled, the GANG function cannot be used. (See “Enabling dual recording” on page 31.)*

Output settings

You can make settings related to analog and digital output.

Analog output settings

You can set the LINE OUTPUT jacks to directly output the sound of each track or to output the stereo mix sound.

When set to output the MIX, the left and right channels of the stereo track are output through the analog output jack 1/2, 3/4 and 5/6 pairs.

1. Press the MENU button to open the I/O page of the MENU screen.
2. Use the DATA wheel to select the LINE OUT menu item, and press the ENTER/MARK button.

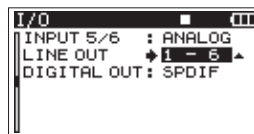

3. Use the DATA wheel to set it to 1–6 (default value) or MIX x3.
1–6 : The sound of each channel is output directly.
MIX x3 : The stereo signal mixed by the internal mixer is output.
4. When you have finished making the setting, press the HOME/DISP button to return to the Home Screen.

9 – Other Settings and Information Display

Digital output settings

You can set the digital output format to SPDIF or AES/EBU.

1. Press the **MENU** button to open the I/O page of the MENU screen.
2. Use the **DATA** wheel to select the DIGITAL OUT menu item, and press the **ENTER/MARK** button.

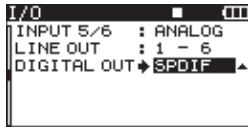

3. Use the **DATA** wheel to select SPDIF (default value) or AES/EBU.
SPDIF : Output in SPDIF format.
AES/EBU : Output in AES/EBU format.
4. When you have finished making the setting, press the **HOME/DISP** button to return to the Home Screen.

System settings

Use the SYSTEM page to make various settings to suit the environment and conditions in which the unit is to be used, as well as to view system information.

1. Press the **MENU** button to open the SYSTEM page of the MENU screen.

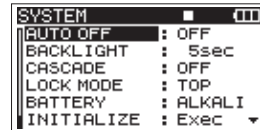

On the SYSTEM menu screen, you can make various settings described below.

Use the **MARK** (**◀**) and (**▶**) buttons, **ENTER/MARK** button and the **DATA** wheel to select each item.

2. When you have finished making the settings, press the **HOME/DISP** button to return to the Home Screen.

Power AUTO OFF settings

Use the AUTO OFF item to set the amount of time since being last used until the unit's power automatically turns OFF when operating on batteries.

Options: OFF (default value—AUTO OFF disabled), 3min, 5min, 10min, 30min

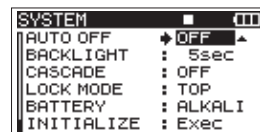

Turning the backlight off automatically

Use the BACKLIGHT item to set the amount of time since being last used until the backlight automatically turns OFF when operating on batteries.

Options: OFF, 5sec (default value), 10sec, 15sec, 30sec

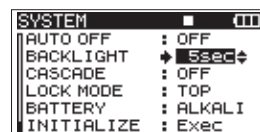

9 – Other Settings and Information Display

Cascade settings

Use the **CASCADE** item to set the cascade function.

Options: OFF (default value—cascade disabled), MASTER, SLAVE

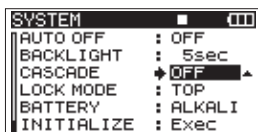

Setting the extent of the panel operation lock function

Use the **LOCK MODE** item to set the lock function.

You can set which controls are disabled when you engage the panel operation lock function, which is activated by pressing and holding the **MIX [LOCK]** button.

TOP : Button operation of the top panel is disabled.

FRONT : Button operation of the front panel is disabled.

T+F : Button operation of both the front and top panels is disabled.

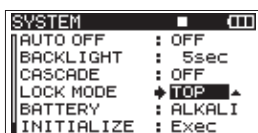

Setting the battery type

Use the **BATTERY** item to set the type of battery used.

The unit uses this setting to display the remaining battery charge and determine the minimum necessary remaining charge for correct operation.

Options: ALKALI (alkaline batteries (default value)), NiMH (nickel metal hydride batteries), LiFeS2 (lithium battery)

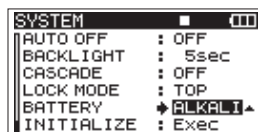

Initializing the unit

Use the **INITIALIZE** item to restore the various settings of this unit to their initial settings.

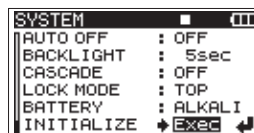

When selecting **Exec** item, press the **ENTER/MARK** button to open a confirmation screen.



Press the **ENTER/MARK** button to initialize the unit. Press the **STOP** button to cancel initialization.

After completing or canceling initialization, the **SYSTEM** page reopens.

Viewing system information

Use the **INFORMATION** item to view information about the unit's system settings and the firmware version.

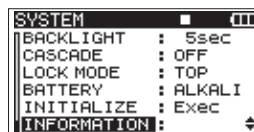

Press the **ENTER/MARK** button to open the system information screen.

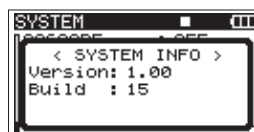

This page shows information about the system firmware version.

When the **INFORMATION** screen is open, press the **ENTER/MARK** button to return to the **SYSTEM** screen.

9 – Other Settings and Information Display

Reformatting SD cards

You can reformat an SD card that is in the unit.

CAUTION

- If you format a card, all information, including takes and folders, on it is erased.
- When formatting, use the AC adaptor or confirm that the remaining battery charge is sufficient. If the batteries run out of power during this operation, the formatting might not be completed correctly.

1. Press the **MENU** button to open the **CARD** page of the **MENU** screen.
2. Use the **DATA** wheel to select the **FORMAT** item, and press the **ENTER/MARK** button to open the following screen.



3. Press the **ENTER/MARK** button again to open the following screen.



4. Use the **DATA** wheel to select one of the following settings.
Options: **QUICK FORMAT** (default), **ERASE FORMAT**

NOTE

Using the **ERASE FORMAT** option might restore an SD card that has decreased writing performance due to repetitive use.

5. Press the **ENTER/MARK** button to open a confirmation screen.



6. Press the **ENTER/MARK** button again to start formatting.

NOTE

When **ERASE FORMAT** is being executed, you can press the **MARK** (I◀) button on the top of the unit to cancel. Doing this will have the same result as using **QUICK FORMAT**.

7. When formatting completes, the **CARD** screen reopens.

Viewing SD card information

On the **CARD** page, information about the status of the currently inserted SD card is shown.

1. Press the **MENU** button to open the **CARD** page of the **MENU** screen.
2. Use the **DATA** wheel to select the **INFORMATION** item, and press the **ENTER/MARK** button.

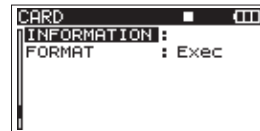

A pop-up showing the use status of the SD card will appear.

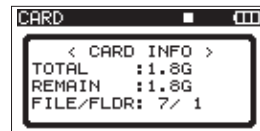

TOTAL

Shows the total memory capacity of the SD card.

REMAIN

Shows the remaining capacity of the SD card.

FILE/FLDR

Shows the total number of files and folders inside the **MUSIC** folder.

10 – Messages

The following is a list of the pop-up messages that might appear on the DR-680MKII under certain conditions.

Refer to this list if one of these pop-up messages appears and you want to check the meaning or determine a suitable response.

Message	Meaning and response
Battery Empty	The battery is almost out of power. Replace the AA batteries.
MBR Error Init CARD	The card is not formatted properly or the formatting is broken. Change the card or press the ENTER/MARK button when this message appears to format the card in FAT format. CAUTION: Execution of FAT formatting erases all data currently on the card.
Format Error Format CARD	The FAT formatting of the card is abnormal or broken. This message also appears if you FAT formatted the card using a computer connected by USB and if a new card is inserted in the unit. Always use the DR-680MKII to conduct FAT formatting of cards to be used with it. Change the card or press the ENTER/MARK button when this message appears to format the card in FAT format. CAUTION: Execution of FAT formatting erases all data currently on the card.
File Not Found Make Sys File	The system file is missing. This unit requires a system file for operation. When this message appears, press ENTER/MARK to automatically create a system file.
Invalid SysFile Make Sys File	The system file required to operate this unit is invalid. When this message appears, press ENTER/MARK to automatically create a system file.
Invalid Card Change Card	Something might be wrong with the card. Change the card. This message will appear with SDXC cards of 256 GB or larger.
Protected Card Change Card	This appears when the card is protected and lacks the necessary MUSIC Folder and other folders and files. Unlock the write protect switch, restart the power and format the card.
Write Timeout	Writing to the SD card was not fast enough. Back up files to a computer and then use the ERASE FORMAT function on the unit. If this occurs even after formatting the SD card, the card transmission rate is too slow. Change the SD card.
Card Full	The SD card has no remaining capacity. Erase unnecessary takes or move them to your computer to make open space.
Max File Size	The file is larger than the designated size or the recording time exceeded 24 hours.
File Full	The total number of folders and files exceeds 5000. Erase unnecessary files or move them to your computer.
Take Full	The total number of takes exceeds 1000. Erase unnecessary takes or move them to your computer.
Card Error	The SD card could not be handled properly. Replace the card.
File Protected	The take includes the read only file and cannot be erased.
No Card	No SD card is loaded. Insert a recordable SD card.
File Not Found in TAKE	An audio file could not be found inside the take. The audio files in the take might have been erased or renamed using a PC. Restore the files or erase the take using the BROWSE screen.
DIN unlock	When the DIGITAL/SYNC IN input is selected, the DIGITAL IN connection has been lost or the sampling frequency is incorrect. Confirm that the external digital device is connected to the DIGITAL/SYNC IN jack correctly. Confirm that the sampling frequency used by the external digital device and this unit are compatible. Press the STOP button to close this message. If you do this, you will not be able to use the DIGITAL/SYNC IN , but otherwise recording will be possible. If this message appears during recording, noise might be recorded."
DIN lock	DIN unlock status has ended. DIGITAL IN has become possible. Press the STOP button to close this message. If this message appears during recording, noise might be recorded."

10 – Messages

Message	Meaning and response
Not Continued	If any of these errors occur, turn the unit power OFF and restart it. If the power cannot be turned OFF, remove the batteries and disconnect the AC adaptor (if connected). If the error message continues to appear, please contact a TASCAM Service Center.
File Error	
Can't Save Data	
Player Error	
Device Error	
Writing Failed	
Sys Rom Err	
System Err 50	
System Error 1	
System Error 2	
System Error 3	
System Error 4	
System Error 5	
System Error 6	
System Error 7	
System Error 8	
System Error 9	

11 – Troubleshooting

If you are having trouble with the operation of this unit, please try the following before seeking repair. If these measures do not solve the problem, please contact the store where you bought the unit or a TASCAM Service Center.

■ Power will not turn ON.

- Confirm that the batteries are not dead.
- Confirm that the batteries are installed with the correct ⊕/⊖ orientations.
- Confirm that the power plug of the AC adaptor (GPE248-120200-Z) is connected securely.

■ The unit is not responding to operations.

- Is the button lock function ON?

■ SD card is not recognized.

- Confirm that the SD card is inserted securely.

■ Playback is not possible.

- If it is a WAV/BWF file, confirm that it is of a compatible sampling frequency.
- If it is an MP3 file, confirm that it is of a compatible bit-rate.

■ No sound is output from the built-in speaker

- Are headphones connected?
- Is the SPEAKER item set to OFF?
- Is the volume level of the headphones minimized?

■ No sound is output from the headphones

- Is the volume level of the headphones minimized?

■ No sound is output from the monitoring system

- Confirm that the monitoring system is connected correctly.
- Is the volume level of the connected monitoring system minimized?
- Is the output level of this unit minimized?

■ Recording is not possible.

- Reconfirm connections.
- Reconfirm the input settings.
- Check whether the recording level is too low.
- Confirm that the SD card is not full.
- Confirm that the maximum number of files or takes has not been reached.

■ The recording level is low.

- Is the trim setting too low?
- Is the **MIC GAIN** set to **LOW**?
- Is the output level of a connected external device too low?

■ The sound I am trying to record is distorted.

- Is the trim setting too high?
- Is the **MIC GAIN** set to **HIGH**?

■ I cannot erase a file.

- Confirm that the SD card is not write-protected.
- Are you trying to delete a file that has been set to read-only on a computer?

■ Files on this device do not appear on a computer.

- Confirm that the USB port of the unit is connected with the computer.
- Are you using a USB hub?
- Is the unit recording or in recording standby?

Recording media and formats

Recording media

- SD card (64MB – 2 GB)
- SDHC card (4 GB – 32 GB)
- SDXC card (48 GB – 128 GB)

Supported recording and playback formats

- BWF: 16/24-bit, 44.1/48/96/192 kHz
- WAV: 16/24-bit, 44.1/48/96/192 kHz
- MP3: 96/128/192/320 kbps, 44.1/48 kHz

Number of tracks

- 6 tracks and a stereo mix track
 - BWF: 44.1/48/96 kHz
 - WAV: 44.1/48/96 kHz
 - MP3: 44.1/48 kHz
- 2 tracks
 - BWF: 192 kHz
 - WAV: 192 kHz

File recording modes

- BWF: monaural, stereo, 6-channel
- WAV: monaural, stereo, 6-channel
- MP3: monaural, stereo

Input and output

Analog audio input and output

MIC/LINE INPUTS

Connectors:

- XLR-3-31
(1: GND, 2: HOT, 3: COLD)
- 6.3mm (1/4") standard TRS jacks
(Tip: HOT, Ring: COLD, Sleeve: GND)

INPUT switch set to MIC (phantom power supported)

Input impedance: 2.4 k Ω

Nominal input level:

- GAIN LOW: -20 dBu (0.11 V)
- GAIN HIGH: -44 dBu (6.91 mV)

Maximum input level:

- GAIN LOW: +3 dBu (1.55 V)
- GAIN HIGH: -21 dBu (0.098 V)

Minimum input level:

- GAIN LOW: -51.5 dBu (2.0 mV)
- GAIN HIGH: -75.5 dBu (0.1 mV)

INPUT switch set to LINE

Input impedance: 10 k Ω

Nominal input level: +4 dBu (1.23 V)

Maximum input level: +24 dBu (12.3 V)

Minimum input level: -27.5 dBu (0.05 V)

LINE OUTPUTS jacks

Connectors: standard RCA pin jacks

Output impedance: 200 Ω

Nominal output level: -10 dBV (0.3 V)

Maximum output level: +6 dBV (2.0 V)

PHONES jack

Connector: standard 6.3 mm (1/4") stereo jack

Maximum output: 50 mW + 50 mW (into 32 Ω load)

Built-in speaker

500 mW (monaural)

12 – Specifications

Digital audio input and output

DIGITAL/SYNC IN jack

Connector: RCA pin jack

Format: IEC60958-3 (S/PDIF) or AES3-2003/IEC60958-4 (AES/EBU) automatically determined

DIGITAL/SYNC OUT jack

Connector: RCA pin jack

Format: IEC60958-3 (S/PDIF) or AES3-2003/IEC60958-4 (AES/EBU) set by user

Control input and output

USB connection

USB port connector: Mini-B type

Format: USB2.0 HIGH SPEED (480 Mbps)

Audio performance

(From LINE IN to LINE OUT, Input level = FS –1 dB)

Frequency response

20 Hz-20 kHz +0.5/–1.5 dB (44.1 kHz)

20 Hz-20 kHz +0.5/–0.5 dB (48 kHz)

20 Hz-40 kHz +0.5/–1.0 dB (96 kHz)

20 Hz-80 kHz +0.5/–5.0 dB (192 kHz)

Distortion

0.007% (1 kHz)

S/N ratio

100 dB (A-weighted)

Other specifications

Power supply

8 AA batteries (alkaline, NiMH or lithium)

AC adaptor (GPE248-120200-Z, 100-240V, 50-60 Hz, included)

Power consumption

100-120V: 9W (When phantom power ON and GPE248-120200-Z AC adaptor used)

220-240V: 9.5W (When phantom power ON and GPE248-120200-Z AC adaptor used)

Battery operation time (when used continuously)

Alkaline batteries (EVOLTA)

About 3.5 hours (6 channels of phantom power used, 3 mA per channel)

About 4.5 hours (2 channels of phantom power used, 3 mA per channel)

About 6 hours (phantom power not used)

NiMH batteries (eneloop)

About 4 hours (6 channels of phantom power used, 3 mA per channel)

About 4.5 hours (2 channels of phantom power used, 3 mA per channel)

About 5.5 hours (phantom power not used)

Lithium batteries (Energizer Ultimate Lithium)

About 7.5 hours (6 channels of phantom power used, 3 mA per channel)

About 9.5 hours (2 channels of phantom power used, 3 mA per channel)

About 11 hours (phantom power not used)

Dimensions (width x height x depth)

216.4 x 56 x 188.4 mm

8.52 x 2.21 x 7.41 in

Weight

1.2 kg/2.646 lb (without batteries)

Operating temperature range

0–40° C/32–104° F

Dimensions

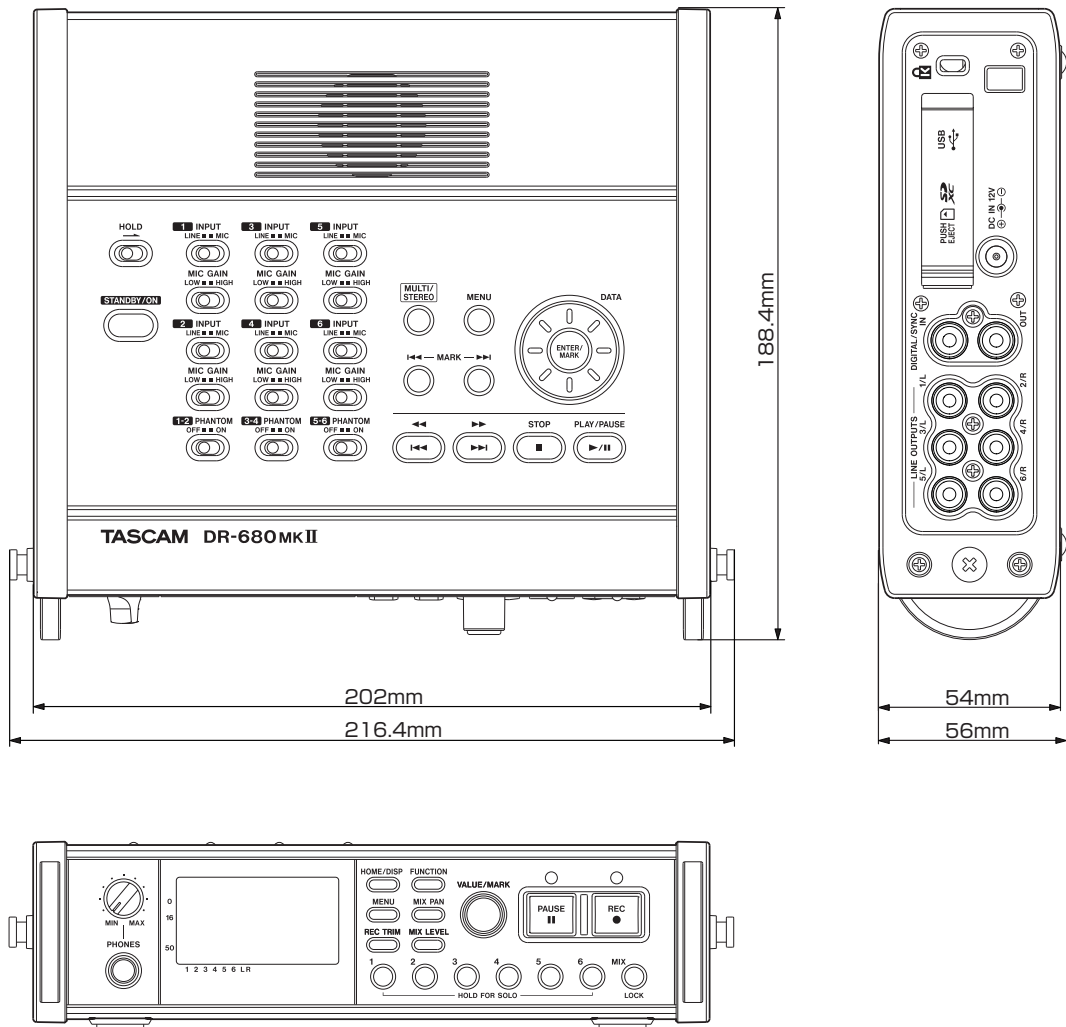

- Illustrations in this manual might differ from the actual product.
- In order to improve the product, specifications and appearance could be changed without prior notice.

12 – Specifications

Block diagrams

Recording

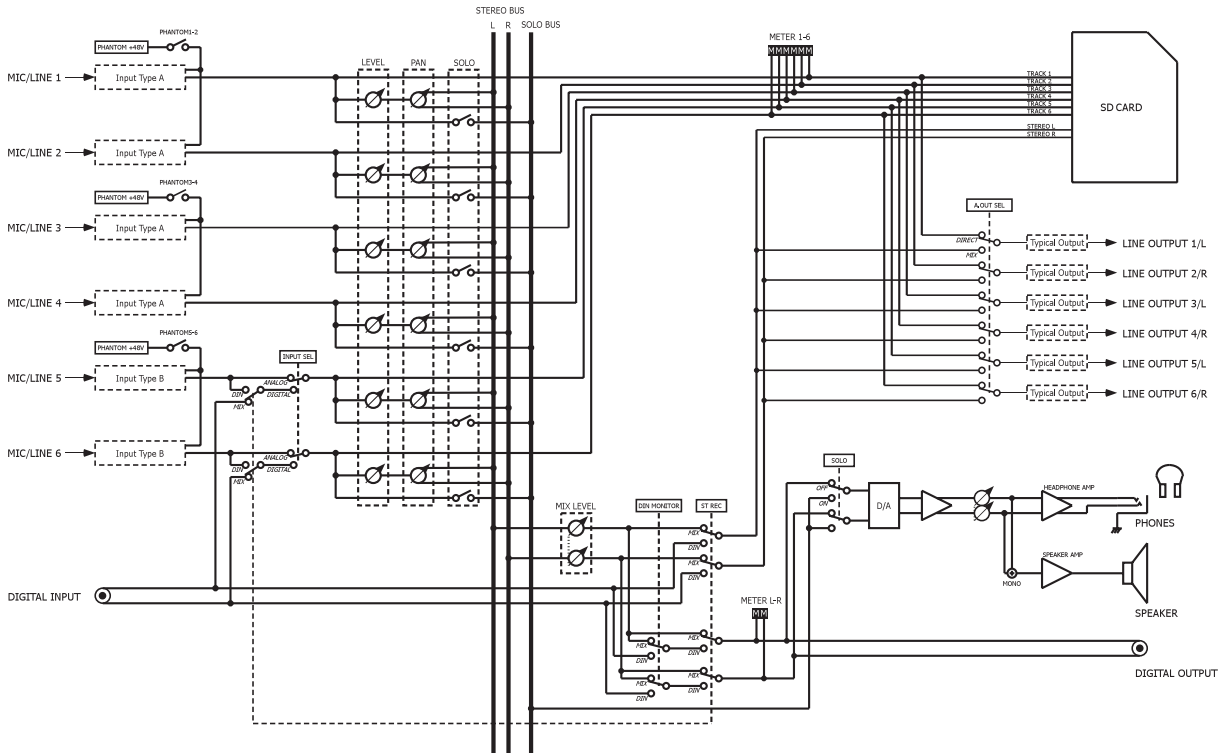

Play

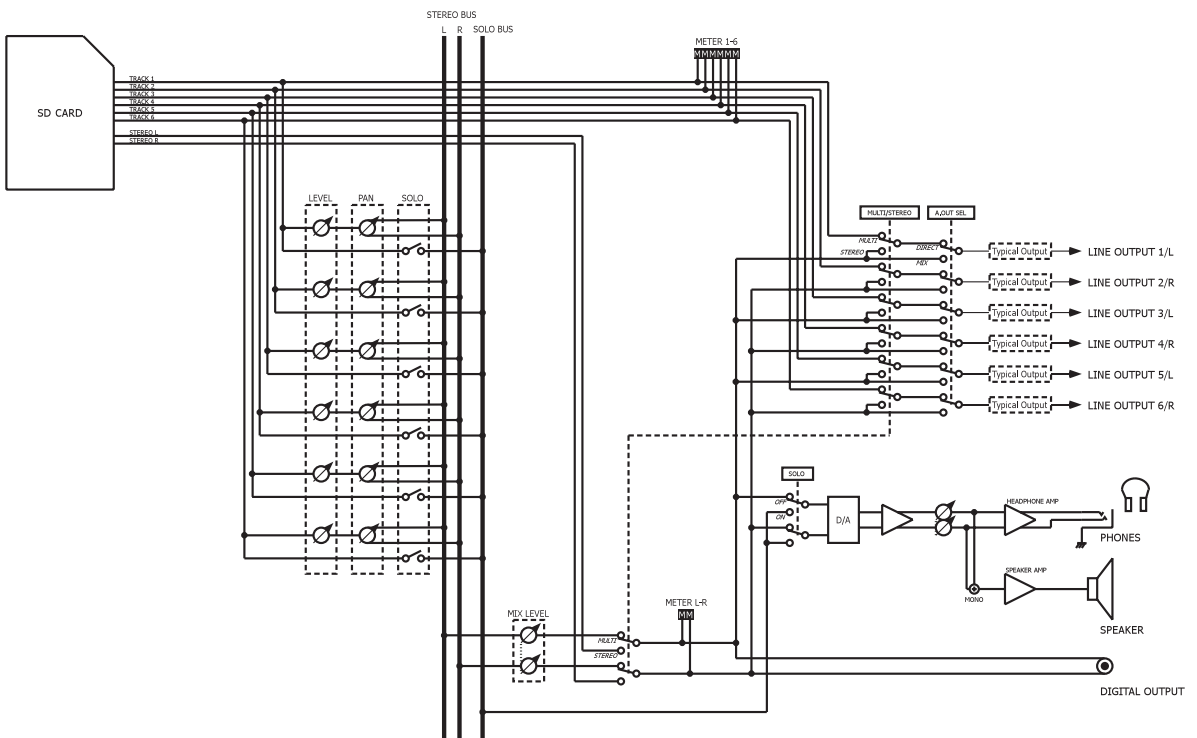

I/O

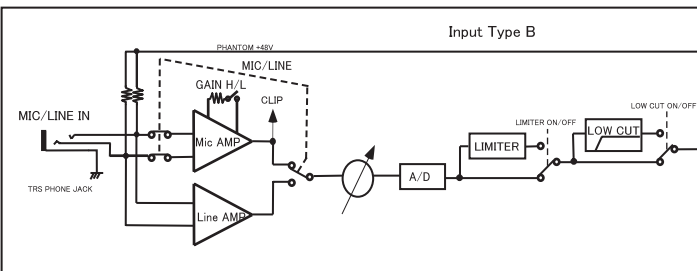
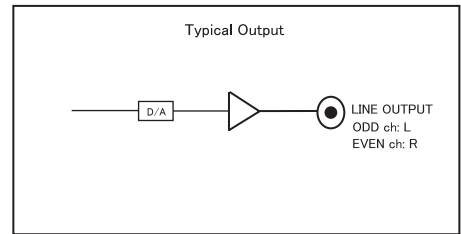
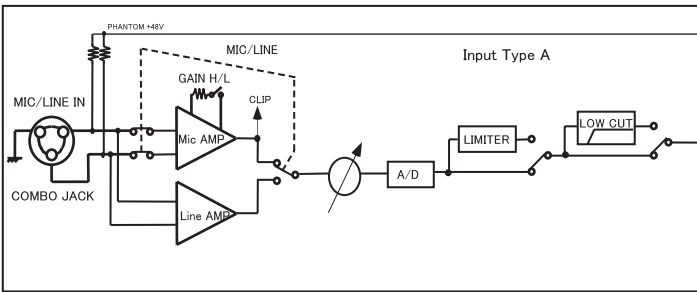

WARRANTY

< In the United States >

This warranty gives you specific legal rights and you may also have other rights which vary from state to state. This warranty is only valid within the country the unit was originally purchased.

WHAT IS AND IS NOT COVERED

Except as specified below, this warranty covers all defects in materials and workmanship in this product. The following are not covered by the warranty:

1. **Damage to or deterioration of the external cabinet.**
2. **Damages resulting from accident, misuse, abuse or neglect.**
3. **Damage resulting from failure to perform basic daily maintenance and/or calibration or otherwise resulting from failure to follow instructions contained in your owner's manual.**
4. **Damage occurring during shipment of the product. (Claims must be presented to the carrier)**
5. **Damage resulting from repair or attempted repair by anyone other than TEAC or an authorized TASCAM service station.**
6. **Damage resulting from causes other than product defects, including lack of technical skill, competence, or experience of the user.**
7. **Damage to any unit which has been altered or on which the serial number has been defaced, modified or is missing.**

WHO MAY ENFORCE THE WARRANTY

This warranty may be enforced only by the original purchaser.

LENGTH OF WARRANTY

All parts except heads and disk drives are warranted for one (1) year from the date of original purchase. Heads and disk drives are warranted to ninety (90) days from date of original purchase. Labor is warranted for ninety (90) days from date of original purchase.

WHAT WE WILL PAY FOR

We will pay all labor and material expenses for items covered by the warranty. Payment of shipping charges is discussed in the next section of this warranty.

HOW YOU CAN GET WARRANTY SERVICE

Your unit must be serviced by an authorized TASCAM service station in the United States. (This warranty is not enforceable outside the U.S.) If you are unable to locate an authorized TASCAM service station in your area, please contact us. We either will refer you to an authorized service station or instruct you to return the unit to the factory. Whenever warranty service is required, you must present a copy of the original dated sales receipt from an Authorized TASCAM Dealer.

You must pay any shipping charges if it is necessary to ship the product to service. However, if the necessary repairs are covered by the warranty, we will pay return surface shipping charges to any destination within the United States.

LIMITATION OF IMPLIED WARRANTIES

Any implied warranties, INCLUDING WARRANTIES OF MERCHANTABILITY AND FITNESS FOR A PARTICULAR PURPOSE, are limited in duration to the length of this warranty.

EXCLUSION OF DAMAGES

TEAC's liability for any defective product is limited to repair or replacement of the product, at TEAC's option. TEAC shall not be liable for:

1. **Damages based upon inconvenience, loss of use of the product, loss of time interrupted operation or commercial loss; or**
2. **Any other damages, whether incidental, consequential or otherwise.**

Some states do not allow limitations on how long an implied warranty lasts and/or do not allow the exclusion or limitation of incidental or consequential damages, so the above limitations and exclusions may not apply to you.

To locate an Authorized Service Center in Your Area

CALL 1-800-447-8322

< Europe >

This product is subject to the legal warranty regulations of the country of purchase. In case of a defect or a problem, please contact the dealer where you bought the product.

Ce produit est sujet aux réglementations concernant la garantie légale dans le pays d'achat. En cas de défaut ou de problème, veuillez contacter le revendeur chez qui vous avez acheté le produit.

Dieses Gerät unterliegt den gesetzlichen Gewährleistungsbestimmungen des Landes, in dem es erworben wurde. Bitte wenden Sie sich im Gewährleistungsfall an den Händler, bei dem sie das Gerät erworben haben.

Questo apparecchio è conforme alle norme sulla garanzia vigenti nel rispettivo Paese in cui esso è stato acquistato. Si prega di rivolgersi al proprio commerciante, presso il quale è stato acquistato l'apparecchio, nel caso in cui si voglia richiedere una prestazione in garanzia.

Las condiciones de garantía de este aparato están sujetas a las disposiciones legales sobre garantía del país en el que ha sido adquirido. En caso de garantía, debe dirigirse al establecimiento donde adquirió el aparato.

< In other countries/areas >

This warranty gives you specific legal rights, and you may also have other rights that vary by country, state or province.

If you have a warranty claim or request, please contact the dealer where you bought the product.

该保证书赋予了顾客特定的合法权利，并且因国家、州或省等地域的不同，顾客可能拥有其他权利。如需申请或要求保修，请与购买本产品的销售店进行联系。

If you require repair services for your TASCAM equipment, please contact the dealer where the product was purchased from or the TASCAM Distributor in your country. A list of TASCAM Distributors can be found on our website at: <http://teac-global.com/>

TASCAM

TEAC CORPORATION

Phone: +81-42-356-9143

1-47 Ochiai, Tama-shi, Tokyo 206-8530 Japan

<http://tascam.jp/>

TEAC AMERICA, INC.

Phone: +1-323-726-0303

1834 Gage Road, Montebello, California 90640 USA

<http://tascam.com/>

TEAC MEXICO, S.A. de C.V.

Phone: +52-55-5010-6000

Río Churubusco 364, Colonia Del Carmen, Delegación Coyoacán, CP 04100, México DF, México

<http://teacmexico.net/>

TEAC UK LIMITED

Phone: +44-8451-302511

Meridien House, Ground Floor, 69 - 71, Clarendon Road, Watford, Hertfordshire, WD17 1DS, UK

<http://tascam.eu/>

TEAC EUROPE GmbH

Phone: +49-611-71580

Bahnstrasse 12, 65205 Wiesbaden-Erbenheim, Germany

<http://tascam.eu/>

TEAC SALES & TRADING(SHENZHEN) CO., LTD

Phone: +86-755-88311561~2

Room 817, Block A, Hailrun Complex, 6021 Shennan Blvd., Futian District, Shenzhen 518040, China

<http://tascam.cn/>

Printed in China

WARRANTY

Model/Modèle/Modell
Modello/Modelo/型号

Owner's name/Nom du possesseur/Name des Eigentümers
Nome del proprietario/Nombre del propietario/顾客姓名

DR-680MK II
Sample

Serial No./No de Série/Seriennummer
Numero di serie/Número de serie/序列号

Address/Adresse/Adresse
Indirizzo/Dirección/顾客地址

Date of purchase/Date de l'achat/Datum des Kaufs
Data dell'acquisto/Fecha de compra/购买日期

Dealer's name/Nom du détaillant/Name des Händlers
Nome del commerciante/Nombre del establecimiento/销售店名

TASCAM

<http://teac-global.com/>

Dealer's address/Adresse du détaillant/Adresse des Händlers
Indirizzo del commerciante/Dirección del establecimiento/销售店地址

Free Manuals Download Website

<http://myh66.com>

<http://usermanuals.us>

<http://www.somanuals.com>

<http://www.4manuals.cc>

<http://www.manual-lib.com>

<http://www.404manual.com>

<http://www.luxmanual.com>

<http://aubethermostatmanual.com>

Golf course search by state

<http://golfingnear.com>

Email search by domain

<http://emailbydomain.com>

Auto manuals search

<http://auto.somanuals.com>

TV manuals search

<http://tv.somanuals.com>