

EGOTERIC

SZ-1

Super Audio CD Player
Owner's Manual





CAUTION
RISK OF ELECTRIC SHOCK
DO NOT OPEN



CAUTION: TO REDUCE THE RISK OF ELECTRIC SHOCK, DO NOT REMOVE COVER (OR BACK). NO USER-SERVICEABLE PARTS INSIDE. REFER SERVICING TO QUALIFIED SERVICE PERSONNEL.



The lightning flash with arrowhead symbol, within an equilateral triangle, is intended to alert the user to the presence of uninsulated "dangerous voltage" within the product's enclosure that may be of sufficient magnitude to constitute a risk of electric shock to persons.



The exclamation point within an equilateral triangle is intended to alert the user to the presence of important operating and maintenance (servicing) instructions in the literature accompanying the appliance.

IMPORTANT SAFETY INSTRUCTIONS

- 1) Read these instructions.
 - 2) Keep these instructions.
 - 3) Heed all warnings.
 - 4) Follow all instructions.
 - 5) Do not use this apparatus near water.
 - 6) Clean only with dry cloth.
 - 7) Do not block any ventilation openings. Install in accordance with the manufacturer's instructions.
 - 8) Do not install near any heat sources such as radiators, heat registers, stoves, or other apparatus (including amplifiers) that produce heat.
 - 9) Do not defeat the safety purpose of the polarized or grounding-type plug. A polarized plug has two blades with one wider than the other. A grounding type plug has two blades and a third grounding prong. The wide blade or the third prong are provided for your safety. If the provided plug does not fit into your outlet, consult an electrician for replacement of the obsolete outlet.
 - 10) Protect the power cord from being walked on or pinched particularly at plugs, convenience receptacles, and the point where they exit from the apparatus.
 - 11) Only use attachments/accessories specified by the manufacturer.
 - 12) Use only with the cart, stand, tripod, bracket, or table specified by the manufacturer, or sold with the apparatus. When a cart is used, use caution when moving the cart/apparatus combination to avoid injury from tip-over.
-
- 13) Unplug this apparatus during lightning storms or when unused for long periods of time.
 - 14) Refer all servicing to qualified service personnel. Servicing is required when the apparatus has been damaged in any way, such as power-supply cord or plug is damaged, liquid has been spilled or objects have fallen into the apparatus, the apparatus has been exposed to rain or moisture, does not operate normally, or has been dropped.
 - Do not expose this apparatus to drips or splashes.
 - Do not place any objects filled with liquids, such as vases, on the apparatus.
 - Do not install this apparatus in a confined space such as a book case or similar unit.
 - The apparatus draws nominal non-operating power from the AC outlet with its STANDBY switch in the standby position.
 - The apparatus should be located close enough to the AC outlet so that you can easily grasp the power cord plug at any time.
 - An apparatus with Class I construction shall be connected to an AC outlet with a protective grounding connection.

WARNING: TO PREVENT FIRE OR SHOCK HAZARD, DO NOT EXPOSE THIS APPLIANCE TO RAIN OR MOISTURE.

CAUTION

- DO NOT REMOVE THE EXTERNAL CASES OR CABINETS TO EXPOSE THE ELECTRONICS. NO USER SERVICEABLE PARTS ARE WITHIN!
- IF YOU ARE EXPERIENCING PROBLEMS WITH THIS PRODUCT, CONTACT TEAC FOR A SERVICE REFERRAL. DO NOT USE THE PRODUCT UNTIL IT HAS BEEN REPAIRED.
- USE OF CONTROLS OR ADJUSTMENTS OR PERFORMANCE OF PROCEDURES OTHER THAN THOSE SPECIFIED HEREIN MAY RESULT IN HAZARDOUS RADIATION EXPOSURE.

For U.S.A.

This equipment has been tested and found to comply with the limits for a Class B digital device, pursuant to Part 15 of the FCC Rules. These limits are designed to provide reasonable protection against harmful interference in a residential installation. This equipment generates, uses, and can radiate radio frequency energy and, if not installed and used in accordance with the instructions, may cause harmful interference to radio communications. However, there is no guarantee that interference will not occur in a particular installation. If this equipment does cause harmful interference to radio or television reception, which can be determined by turning the equipment off and on, the user is encouraged to try to correct the interference by one or more of the following measures:

- Reorient or relocate the equipment and/or the receiving antenna.
- Increase the separation between the equipment and receiver.
- Connect the equipment into an outlet on a circuit different from that to which the receiver is connected.
- Consult the dealer or an experienced radio/TV technician for help.

CAUTION

Changes or modifications to this equipments not expressly approved by TEAC CORPORATION for compliance will void the user's warranty.

This product has been designed and manufactured according to FDA regulations "title 21, CFR, chapter 1, subchapter J, based on the Radiation Control for Health and Safety Act of 1968", and is classified as class 1 laser product. There is not hazardous invisible laser radiation during operation because invisible laser radiation emitted inside of this product is completely confined in the protective housings.

The label required in this regulation is shown ①.

① For U.S.A.



(bottom of the unit)

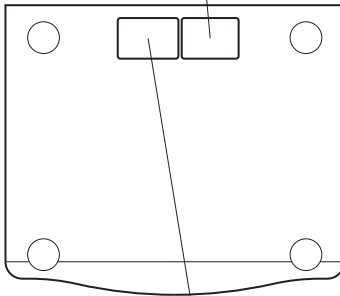

For U.S.A.

THIS DEVICE COMPLIES WITH PART 15 OF THE FCC RULES. OPERATION IS SUBJECT TO THE FOLLOWING TWO CONDITIONS: (1) THIS DEVICE MAY NOT CAUSE HARMFUL INTERFERENCE, AND (2) THIS DEVICE MUST ACCEPT ANY INTERFERENCE RECEIVED, INCLUDING INTERFERENCE THAT MAY CAUSE UNDESIRED OPERATION.

For Canada

THIS CLASS B DIGITAL APPARATUS COMPLIES WITH CANADIAN ICES-003. CET APPAREIL NUMÉRIQUE DE LA CLASSE B EST CONFORME À LA NORME NMB-003 DU CANADA.

Optical pickup :

Type : SPU3162B
 Manufacturer : NIDEC SANKYO CORPORATION
 Laser output : Less than 0.8mW on the objective lens
 Wavelength : 785±15 nm

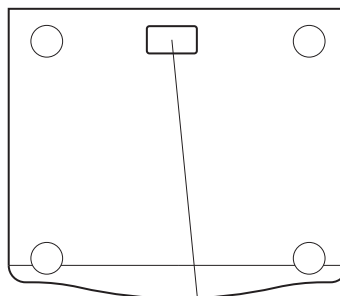

For Europe/Asia/others

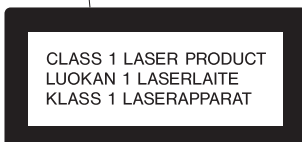

Contents

Thank you for choosing Esoteric. Read this manual carefully to get the best performance from this unit.

- Before Use 4
- Discs 5
- Connections 6
- Front panel features 8
- Understanding the remote control unit 9
- Remote Control Unit 10
- Restoring factory settings 10

- Playback 11
- Skipping playback 12
- Selecting a track 12
- Fast scanning 12
- Selecting the playback area 12
- Repeat mode 13
- Display dimming 13
- Changing the display mode 13
- Word sync 14
- i.LINK (AUDIO) Output Setting 14

- Output Settings 15
- i.LINK (IEEE 1394) 16

- Settings 17

- Troubleshooting 21
- Specifications 22

What's in the box

Please confirm that the following accessories are in the box when you open it.

- Remote control unit x 1
- Batteries (AA, R6, SUM-3) x 2
- Screwdriver x 1
- Felt sheet x 4
- Power cord x 1
- Owner's manual x 1
- Warranty card x 1

Conventions about this manual

- Instructions in this manual describe the controls on the remote control. You can also use the buttons on the front panel if they have the same or similar names as those on the remote.
- The types of functions and operations that can be used for a particular disc vary depending on the features of that disc. In some cases, these functions and operations may differ from the descriptions given in this Owner's Manual.
- The drawings about the front panel display used in this Owner's Manual are purely for the purposes of explanation. The actual displays may differ slightly from what are shown here.

Read this before operation

- Be careful to avoid injury when moving the unit, on account of its weight. Get someone to help you if necessary.
- To protect easily scratched furniture, you may stick the felt supplied with the unit to the feet.
- As the unit may become warm during operation, always leave sufficient space around the unit for ventilation.
- The voltage supplied to the unit should match the voltage as printed on the rear panel. If you are in any doubt regarding this matter, consult an electrician.
- Choose the installation location of your unit carefully. Avoid placing it in direct sunlight or close to a source of heat. Also avoid locations subject to vibrations and excessive dust, heat, cold or moisture.
- Do not place the unit on the amplifier/receiver.
- Do not open the cabinet as this might result in damage to the circuitry or electrical shock. If a foreign object should get into the unit, contact your dealer or service company.
- When removing the power plug from the wall outlet, always pull directly on the plug, never yank the cord.
- To keep the laser pickup clean, do not touch it, and always close the disc tray.
- Do not attempt to clean the unit with chemical solvents as this might damage the finish. Use a clean, dry cloth.
- Keep this manual in a safe place for future reference.

DO NOT MOVE THE UNIT DURING PLAYBACK

During playback, the disc rotates at high speed. Do NOT lift or move the unit during playback. Doing so may damage the disc or the unit.

WHEN MOVING THIS UNIT

When changing places of installation or packing the unit for moving, be sure to remove the disc and return the disc tray to its closed position in the player. Then, press the power switch to turn the power off, and disconnect the power cord. Moving this unit with the disc loaded may result in damage to this unit.

CAUTION

Ensure this product is not exposed to dripping or splashing and that no object filled with liquids, such as vases, is placed on the product.

Do not install this equipment in a confined space such as a book case or similar unit. Allow adequate air circulation around this product.

For European customers

Disposal of your old appliance



1. When this crossed-out wheeled bin symbol is attached to a product it means the product is covered by the European Directive 2002/96/EC.
2. All electrical and electronic products should be disposed of separately from the municipal waste stream via designated collection facilities appointed by the government or the local authorities.
3. The correct disposal of your old appliance will help prevent potential negative consequences for the environment and human health.
4. For more detailed information about disposal of your old appliance, please contact your city office, waste disposal service or the shop where you purchased the product.



"Super Audio CD" is a registered trademark.

"DSD" is a registered trademark.

The i.LINK logo is a trademark of Sony Corporation, registered in the U.S. and other countries.

Type of discs that can be played on this system

This player can playback discs bearing any of the following logos:

	<p>Audio CD:</p> <ul style="list-style-type: none"> • 12cm or 8cm discs • Linear PCM digital audio <p>Audio CDs are divided into tracks.</p>
	<p>Super Audio CD:</p> <ul style="list-style-type: none"> • Single layer, dual layer or Hybrid layer • 12cm or 8cm discs • Digital audio (DSD) <p>Super Audio CDs are divided into tracks.</p>

About CD-R/CD-RW

CD-R/RW discs recorded in Audio CD format and finalized correctly are playable. But depending on the quality of the disc and/or the condition of the recording, some CD-R & CD-RW discs may not be playable.

Caution:

- If you record a disc using a personal computer, even if it is recorded in a compatible format, there are cases in which it may not play because of the settings of the application software used to create the disc. (Check with the software publisher for more detailed information.)
- Unfinalized CD-R/CD-RW discs cannot be played.

Following discs cannot be played with this unit:

- DVD, CD-G, Data part of CD-EXTRA, PHOTO CD, CD-ROM and DVD-ROM discs
- illegally produced discs
- scratched or damaged discs
- discs that are dusty, soiled or marked with fingerprints

Warning:

If you attempt to play back such discs, there is a risk that sudden loud noise can blast over the speakers at full volume and cause damage to the speakers and your hearing.

Copy-protected discs, DualDiscs and other discs that do not conform to the CD standard may not play back correctly in this player. If you use such discs in this unit, TEAC ESOTERIC COMPANY cannot be responsible for any consequences or guarantee the quality of reproduction. If you experience problems with such non-standard discs, you should contact the producers of the disc.

- Always place the disc on the disc tray with the label side up. (Compact discs can be played or recorded only on one side.)
- To remove a disc from its storage case, press down on the center of the case and lift the disc out, holding it carefully by the edges.



How to remove the disc



How to hold the disc

- Should the disc become dirty, wipe the surface radially (from the center hole outward towards the outer edge) with a soft, dry cloth:



- Never use such chemicals as record sprays, antistatic sprays or fluid, benzene or thinner to clean the discs. Such chemicals will do irreparable damage to the disc's plastic surface.
- Discs should be returned to their cases after use to avoid dust and scratches that could cause the laser pickup to "skip."
- Do not expose discs to direct sunlight or high humidity and temperature for extended periods. Long exposure to high temperatures will warp the disc.
- Do not play any disc that is warped, deformed or damaged. Playing such discs may cause irreparable harm to the playing mechanisms.
- CD-R and CD-RW discs are more sensitive to the effects of heat and ultraviolet rays than ordinary CDs. It is important that they are not stored in a location where direct sunlight will fall on them, and which is away from sources of heat such as radiators or heat-generating electrical devices.
- Printable CD-R and CD-RW discs aren't recommended, as the label side might be sticky and damage the unit.
- Do not stick papers or protective sheets on the discs and do not use any protective coating spray.
- Use a soft oil-based felt-tipped pen to write the information on the label side. Never use a ball-point or hard-tipped pen, as this may cause damage to the recorded side.
- Never use a stabilizer. Using commercially available CD stabilizers with this unit will damage the mechanisms and cause them to malfunction.
- Do not use irregular shape CDs (octagonal, heart shaped, business card size, etc.). CDs of this sort can damage the unit:

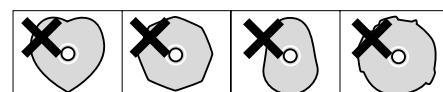

- If you are in any doubt as to the care and handling of a CD-R/CD-RW disc, read the precautions supplied with the disc, or contact the disc manufacturer directly.

Connections

CAUTION:

- Switch off the power to all equipment before making connections.
- Read the instructions of each component you intend to use with this unit.
- Be sure to insert each plug securely. To prevent hum and noise, avoid bundling the signal interconnection cables together with the AC power cord or speaker cables.

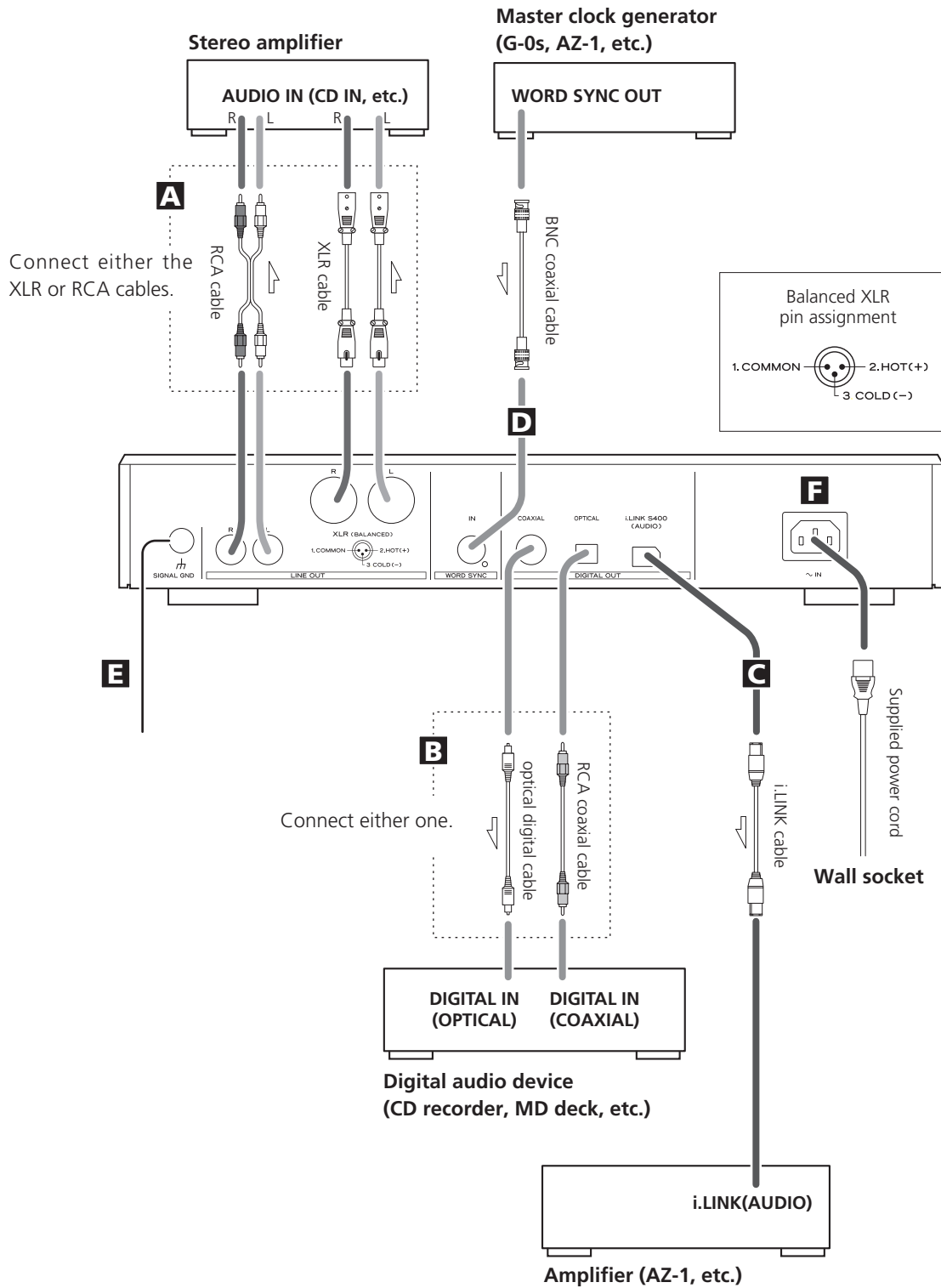

A Analog audio output terminals

Use either the XLR or RCA (pin) terminals for analog stereo output.

XLR: Use balanced XLR audio cable

RCA: Use RCA (pin) audio cable

- When using these terminals, set the Analog Out setting to "2ch" to downmix the multi-channel material to two channels (see page 19).

Note that if the Analog Out setting is set to "Multi ch", only the front L/R sound of the multi-channel material will be output from these terminals.

B Digital audio output terminals

Digital audio from CD is output from these terminals.

The unit may be connected using either coaxial or optical (TOS) commercially available cables to amplifiers, or to digital audio devices such as CD recorders, etc.

COAXIAL: Use RCA (pin) digital audio cable

OPTICAL: Use optical digital audio cable (TOS)

- The optical terminal is covered by a shutter. Make sure that the cable is firmly inserted, but do not force the cable when connecting it or removing it, in order not to cause damage to the unit.
- The DIGITAL OUT terminals cannot output the digital audio from Super Audio CDs.

C i.LINK (AUDIO) terminal

In addition to the digital audio from CD, the digital surround audio from Super Audio CDs can be output from this terminal.

Use a commercially available S400 compatible i.LINK (IEEE1394) 6pin cable to connect the unit to an amplifier.

- When using this terminal, set the i.LINK output setting to "60958" or "PCM" (see page 14).
- See page 16 for further details on i.LINK.
- To enjoy surround sound from a Super Audio CD, connect the i.LINK (AUDIO) terminal to a suitably equipped surround sound amplifier.

D Word sync connector

This allows the use of an externally-generated word clock connection, using a commercially available BNC coaxial cable.

Devices producing such a suitable clock signal include external D-A converters, or dedicated word clock generators. Connect the SYNC OUT (or WORD OUT) of such a device to the unit.

E SIGNAL GND connection

Use a commercially available PVC-covered cord to connect the signal ground terminal on the unit to the amplifier signal ground.

- Note that this is NOT an electrical safety ground (earth).

F Power cord receptacle

After all other connections have been made, insert the supplied AC power cord into this receptacle, then connect the other end of the power cord into the wall socket. Ensure that your AC voltage corresponds to the voltage marked on the rear panel of the unit. Consult a qualified electrician if you are in doubt.

- In order to avoid the risk of electric shock, fire, and so on, only use the supplied power cord.
- If you are not going to use the unit for some time, disconnect the power cord from the wall socket.

Front panel features

Front Panel

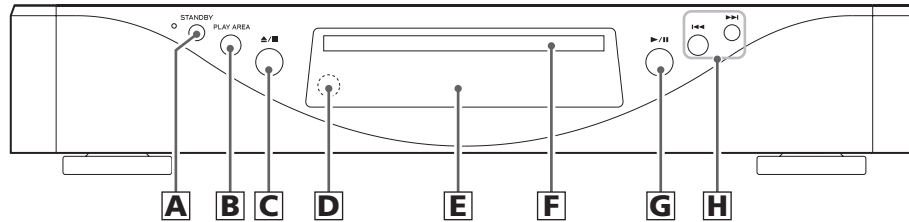

Display

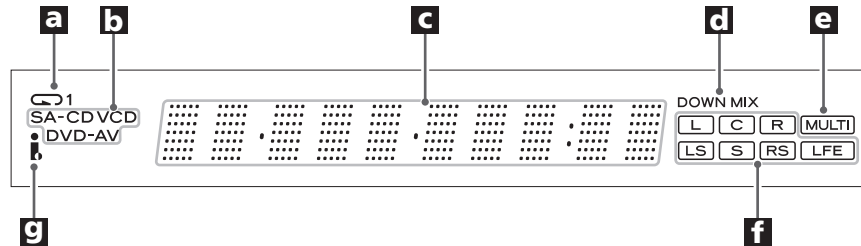

Front Panel

A STANDBY

Use this button to turn the unit on and standby.
The indicator is red in the standby mode. It turns blue when the unit is turned on.

The equipment draws nominal non-operating power from the AC outlet with its STANDBY in the standby position.

B PLAY AREA

When playback is stopped, use this with Super Audio CDs to select the playback area.
Hold down this for more than two seconds to enter the setup mode.

C OPEN/CLOSE/STOP

When playback is stopped, use this to open and close the disc tray.
During playback, use this to stop playback.

D Remote control sensor

Receives signals from the remote control unit. Point the remote control unit at this sensor when operating the remote control unit.

E Display

F Disc tray

G PLAY/PAUSE

Use this to start or pause playback.

H SKIP (◀◀ / ▶▶)

Use these for skip operations. Pressing and holding these buttons for more than a second changes the scanning speed.

Display

a REPEAT indicator

Lights when repeat play is selected.

b Disc type indicator

Shows the type of disc currently loaded.

c Message area

Alphanumeric display to show times, status messages, etc.

d DOWN MIX indicator

Lights to show that a multi-channel source has been downmixed to 2 channels.

e MULTI indicator

Lights when the Analog Out setting is set to "Multi Channel".

f Channel indicators

Light to show which surround channels are currently in use.

g i.LINK indicator

Lights when i.LINK output is enabled.

Understanding the remote control unit

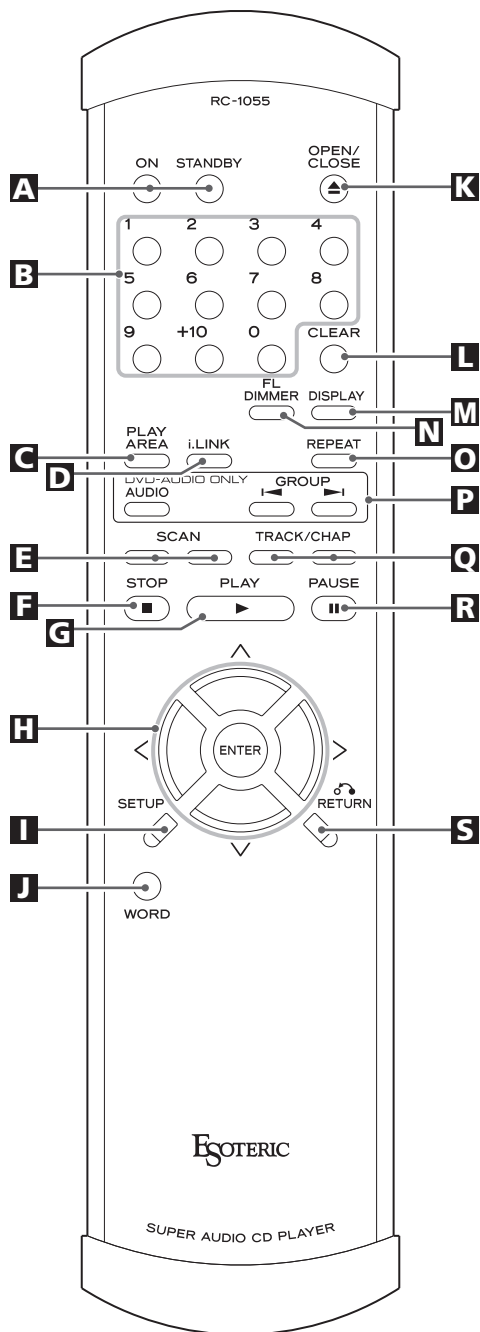

A ON/STANDBY

Use the ON button to turn the unit on. Use the STANDBY button to turn it standby. When you press the ON button, white buttons on the remote control unit light for several seconds.

B Number buttons

Use these for selecting tracks by number, etc.

C PLAY AREA

Use this with Super Audio CDs to select the playback area.

D i.LINK

Use this to turn i.LINK output on and off.

E SCAN (◀◀/▶▶)

Use these for fast scanning during playback.

F STOP

Use this to stop playback.

G PLAY

Use this to start playback.

H Cursor buttons and ENTER

Use these buttons in the setup mode.

I SETUP

Use this button to enter or exit the setup menu.

J WORD

Use this to turn on or off the word sync function. When the word sync is on, the unit will synchronize with an external word sync source.

K OPEN/CLOSE

Use this button to open and close the disc tray.

L Clear button

Use this button to clear entry errors, etc.

M DISPLAY

Use this button to change the display mode.

N FL DIMMER

Use this button to change the brightness of the front panel display.

O REPEAT

Use this button to set the repeat playback mode.

P Buttons for the operation of DVD-Audio

The following are the DVD-Audio-only buttons, and will be made available when the SZ-1 is updated in the future.

AUDIO

During playback of a DVD-Audio disc, press this button to select an audio.

GROUP

During playback of a DVD-Audio disc, press this button to skip groups.

Q SKIP (◀◀/▶▶)

Use these for skip operations.

R PAUSE

Use this to pause playback.

S RETURN

Use this button to go back a level in the setup menu.

Remote Control Unit

How to insert the batteries

Remove the cover of the remote control unit with a screwdriver. After checking the polarity (\oplus/\ominus) of two AA batteries, insert the batteries, replace the cover and replace the screws.

- Take care not to pinch cables with the battery case.

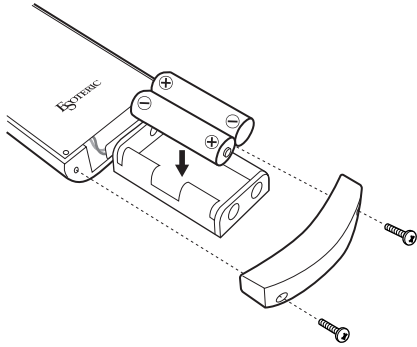

Battery Replacement

If the distance required between the remote control unit and main unit decreases, the batteries are exhausted. In this case replace the batteries with new ones.

Precautions concerning batteries

- Be sure to insert the batteries with correct positive " \oplus " and negative " \ominus " polarities.
- Use batteries of the same type. Never use different types of batteries together.
- Rechargeable or non-rechargeable batteries can be used but not mixed together. Refer to the precautions on their labels.
- When the remote control unit is not to be used for a long time (more than a month), remove the batteries from the remote control unit to prevent them from leaking. If they leak, wipe away the liquid inside the battery compartment and replace the batteries with new ones.
- Do not heat or disassemble batteries and never dispose of old batteries by throwing them in a fire.

Notes on use

- Point the remote control unit at the player's remote sensor within seven meters (23 feet) of the player. There should not be any obstacles between the player and the remote control unit.
- Do not allow direct sun or other light to shine on the remote sensor part of the player. This may cause the remote control unit to work incorrectly.
- Note that other units with remote controls may operate incorrectly because of infrared light "overspill" when you operate this remote control unit.

Restoring factory settings

If you have made a lot of changes to the setup, and want to restart from a known set of options, restore the unit to the factory settings as follows:

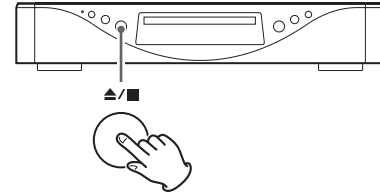

1. Unplug the power cord from the outlet.
2. While holding down the $\blacktriangle/\blacksquare$ button, plug the power cord into the outlet.

All memories are erased, and the unit returns to the factory settings.

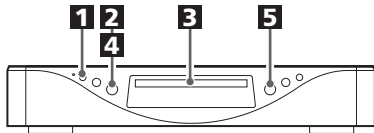

1 Press the STANDBY button to turn the unit on.

The indicator is red in the standby mode. It turns blue when the unit is turned on.

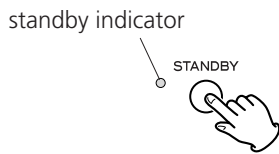

2 Press the OPEN/CLOSE button (▲) to open the tray.



3 Insert the disc label side up.

- In the case of double-sided discs, the side to be played should be face down.
- Make sure the disc is centered in the tray in order to avoid any malfunction or jamming of the tray or damage to the disc.

4 Press the OPEN/CLOSE button (▲) again to close the tray.



The tray will close. Take care that you don't catch your fingers in the tray.

The unit reads the disc (this may take a little time).



5 Press the PLAY button to start playback.



Pausing playback

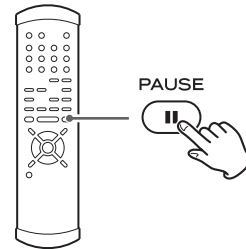

Press the PAUSE button to pause playback. Press PLAY or PAUSE to restart playback.

Stopping playback

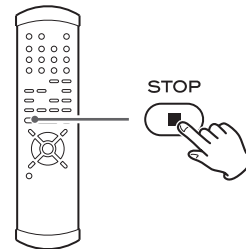

Press the STOP button to stop playback.

Opening and closing the tray

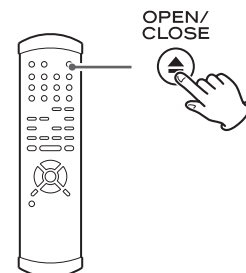

Pressing OPEN/CLOSE opens the tray if it is closed, and closes it if it is open. When the tray is opened during playback, it may take a few seconds before the disc is "unloaded" and the tray opens.

- When playback is stopped, pressing the ▲/■ button of the main unit opens and closes the disc tray.

Skipping playback

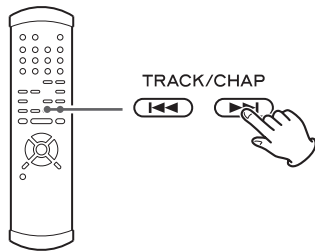

Press the SKIP button (◀◀ or ▶▶) repeatedly until the desired track is found. The selected track will be played from the beginning.

- If the ◀◀ button is pressed once during playback, playback returns to the start of the current track. If it is pressed within one second from the start of the track, playback returns to the start of the previous track (so pressing the button twice in quick succession will skip back two tracks, etc.).
- If tracks are skipped while playback is paused or stopped, playback is paused or stopped at the start of the selected track.

Fast scanning

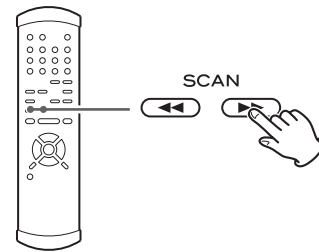

When playing back, use the SCAN button (◀◀ or ▶▶) to move backwards and forwards. Press PLAY to restart playback at normal speed at the desired location.

Repeated presses of the SCAN buttons changes the scanning speeds. There are three speeds:

Fast (1) → Fast (2) → Fast (3) → Play (normal speed)

- You can also use the SKIP buttons of the main unit. To start scanning (or to change the scanning speed), press and hold the SKIP button for more than one second.

Selecting a track

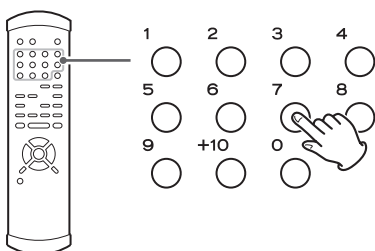

Use the number button to select tracks for playback. Use the +10 button to enter the first digit of numbers greater than 9 (repeated presses show 1-, 2-, 3- etc.) and the single digit buttons (0 through 9) for the second digit, or single-digit track numbers.

Playback starts from the selected track, regardless of whether the number is selected during playback or playback is stopped or paused.

Use the CLEAR button to clear entry mistakes.

Selecting the playback area

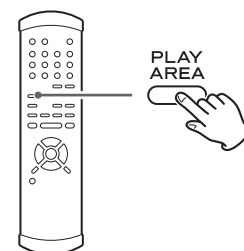

Some Super Audio CDs contain two or more separate audio areas such as multi-channel area, 2 channel area and CD area.

When playback is stopped, use the PLAY AREA button to select the playback area.

Repeat mode

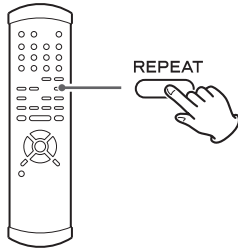

Use the REPEAT button to select the repeat mode for playback. Repeated presses of the REPEAT button cycle between the following options:

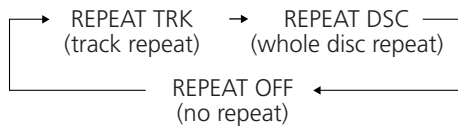

- Halting playback stops the repeat mode.

Track repeat

When this is selected, the currently-selected track repeats. If another track is selected during repeat playback, the newly-selected track repeats.

Disc repeat

The whole contents of the disc are repeated.

Display dimming

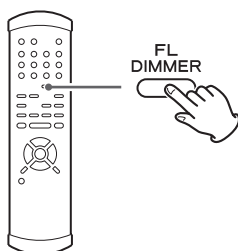

The display on the main unit can be dimmed to suit the environment in which you listen to music. There are three levels and an "off" setting.

Use the FL DIMMER button to cycle between these settings.

- Note that the OFF setting is not memorized when the power is turned off. When the unit is switched off with the display off, and then turned on again, the display is reset to the minimum brightness.
- In OFF mode, when you press a button such as PLAY, the illuminations turn temporarily on.

Changing the display mode

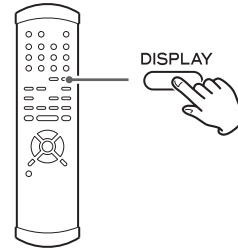

During playback, it is possible to change the display as shown here.

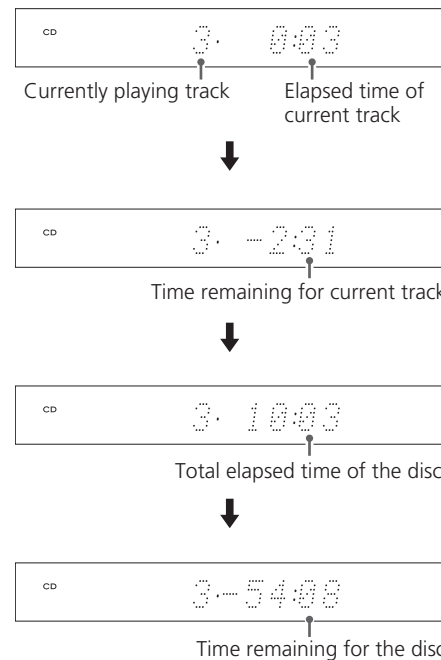

Word sync

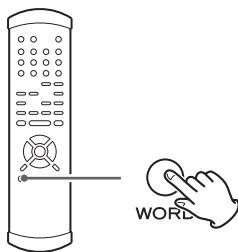

This feature is used when you want to get your whole system locked to a single sync signal (clock) by connecting this unit to the Esoteric AZ-1 or G-0/G-0s or other devices that are capable of outputting a sync signal (word clock).

Use the WORD button to switch between Word ON and Word OFF.

The main unit can accept and synchronize to the following frequencies received from external devices:

44.1kHz, 88.2kHz, 176.4kHz

This unit also accepts a Universal Clock frequency of 100 kHz.

- It takes several seconds for the unit to detect and lock to an external clock.
- Make WORD SYNC connections before powering on the unit. If no valid word sync signal is received, the display shows "No Word!".

i.LINK (AUDIO) Output Setting

When the i.LINK (AUDIO) terminal is connected to an amplifier or a D/A converter, select proper i.LINK output setting.

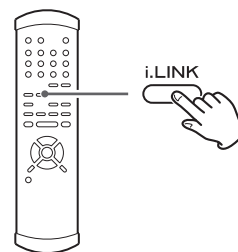

Press the i.LINK button.

Each time the i.LINK button is pressed, the output setting changes.

When using the i.LINK terminal, select "60958" or "PCM", and set the Digital Output setting to "ON".

60958

DSD signal is output during playback of a Super Audio CD.
The digital signal in IEC60958 format is output during playback of a CD.

PCM

DSD signal is output during playback of a Super Audio CD.
Linear PCM digital signal is output during playback of a CD.

- Some amplifiers may regard this signal as DVD-Audio.

OFF

Select this when you don't use the i.LINK (AUDIO) terminal.
No signal is output from the i.LINK (AUDIO) terminal.

- There is no difference between 60958 and PCM as far as Super Audio CD playback is concerned.
- Set the Analog Out setting to "Multi ch" to output the surround sound from a Super Audio CD.
When the Analog Out setting is set to "2ch", the multi-channel sound is downmixed to 2 channels.
- In case you experience any problem with the audio output, read the instructions of the connected component to check the adaptable format.
- If the component connected via the i.LINK terminal is compatible with the flow rate control, the connected component will work in the flow rate control mode.

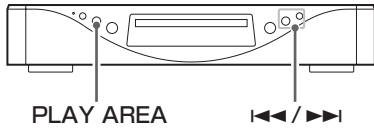

- 1** In the stop mode, press and hold the PLAY AREA button for more than 2 seconds.



The unit enters setup mode, and "i.>***" appears on the display. (***) changes depending on your setting.)

In the following cases, the setup mode will be cancelled:

- Leave the unit idle for 10 seconds.
- Press and hold the PLAY AREA button for more than 2 seconds once again.

- 2** Repeatedly press the PLAY AREA button to select the menu item to be changed.

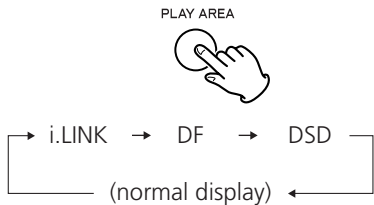

- 3** Use the SKIP buttons (I<<</>>>I) to select the options within the menu item.



- 4** Press and hold the PLAY AREA button for more than 2 seconds (or leave the unit idle for 10 seconds) to exit the setup mode.



- Switching off the power without exiting the setup mode may cause problems. Do not turn the unit off.
- Settings are stored even when power is turned off and the unit is unplugged. If left unplugged for an extended period, the settings may be lost.

Available menu item and options

i.LINK

Used to select an i.LINK output setting. "60958", "PCM" or "OFF" are available.

You can also use the i.LINK button of the remote control unit. See page 14 for details.

DF (Digital Filter)

Used to select a digital filter.

"Wide" or "Narrow" are available.

DSD

Select "Normal" to output DSD after processing and "Direct" to output the audio signal without running it through the processor.

The analog level in the Direct mode is 3 dB lower than in the Normal mode.

(Normal display)

Select this to exit the setting mode.

The i.LINK is also known as IEEE 1394, an international specification.

This unit is ready for i.LINK (AUDIO).

By connecting an i.LINK (AUDIO)-capable device to the IEEE 1394 (or i.LINK (AUDIO) terminal on this unit using an i.LINK cable, you can transmit Super Audio CD multi-channel signals that could not be transmitted but in analog format in the past can be transmitted in its original digital format, in addition to the capability of transmitting 2-ch linear PCM data and multi-channel compressed audio signals.

If you have multiple i.LINK-capable devices, you can connect them through other devices to transmit data between them, so you don't need to be concerned with the order of connection.

Copyright protection system DTCP

To play back audio sounds recorded on Super Audio CD or DVD discs using i.LINK, both the player and the D/A converter need to be ready for the copyright protection system DTCP (Digital Transmission Content Protection).

This unit is ready for DTCP.

Data transfer rate

There are three transfer rates: 100 Mbps (S100), 200 Mbps (S200), and 400 Mbps (S400). This unit is capable of transferring data at a maximum 400Mbps.

For connection to an i.LINK-capable device, use a commercially available S400-compliant 6-pin i.LINK cable.

When connecting multiple i.LINK-capable devices, avoid connecting a device having slow transfer rate between devices having high transfer rate since this reduces the transfer rate of your whole system. Connect devices having high transfer rate towards the source as far upstream as possible.

NOTES

- Among the i.LINK formats there are "MPEG-2 TS" for BS digital source and "DV" for digital video for DVD recorders, as well as the "i.LINK (AUDIO)" (A&M Protocol). Never connect devices that are not ready for i.LINK (AUDIO) to this unit. If you do, this unit and others may get out of order or be damaged.
- In the process of data transfer, avoid plugging/unplugging the i.LINK cables in use or switch on/off the power.
- Among the i.LINK-capable devices there are some that, if not turned on, are not capable of relaying data.
- Chances are some i.LINK-capable devices will not respond to this unit's command.

How to connect multiple i.LINK-capable devices

Daisy chain connection

You can daisy-chain up to 17 devices including this unit.

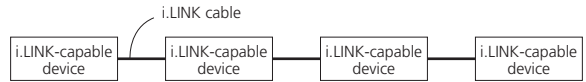

Connection in tree structure

If you are using a device having three or more i.LINK connectors, you may want to get the connection branched out. This way of connection allows you to connect up to 17 devices including this unit.

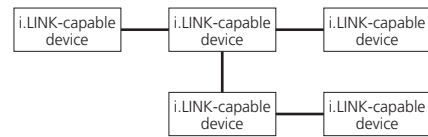

Your system does not work if data is fed back to the output device. Be careful not to create a loop.

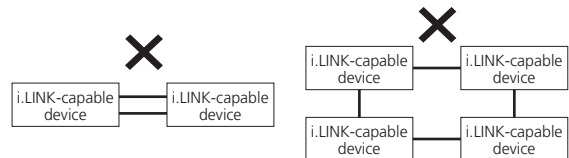

The i.LINK interface of this unit is designed in accordance with the following specifications:

- 1) IEEE Std 1394a-2000, Standard for a High Performance Serial Bus
- 2) Audio and Music Data Transmission Protocol 2.0

This unit is compliant with IEC 60958 bitstream, DVD-Audio, Super Audio CD in the AM824 sequence adaptation layers of this protocol.

Settings (introduction)

1 Turn on the main unit.

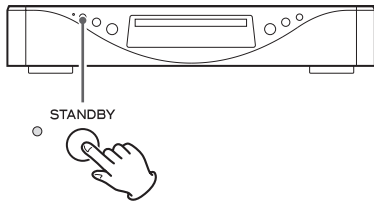

2 Press the SETUP button to enter the setup menu.

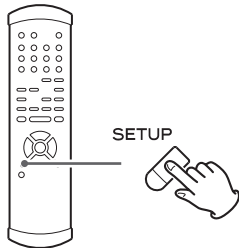

"AudioSetup" appears on the front panel display.

- Although it is possible to enter the setup menu while playback is continuing, not all menu functions will be available. Expand the number of available functions by pressing the STOP button.
- Exit the setup menu by pressing SETUP once again.

3 Use the cursor buttons to navigate the menus.

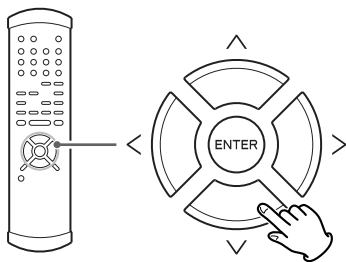

- Refer to the Setup Menu Chart on the next page.
- The options you can change are marked with ">".
- Use the left and up cursor buttons (or the RETURN button) to go back a level in the setup menu.

4 When an option marked with ">" is displayed, use the up or down cursor buttons to change the setting, and press the ENTER button to confirm the entry.

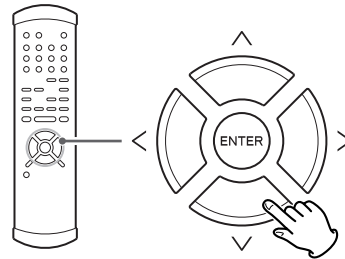

- When a numerical value (such as speaker distance) is changed, the value is confirmed without pressing the ENTER button.
- Individual menu functions are described on pages 19 and 20.
- Repeat steps 3 and 4 as required.

5 Exit the setup menu by pressing SETUP once more.

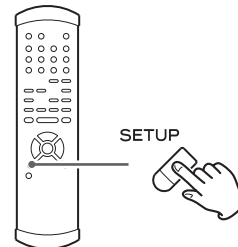

Settings (Setup Menu Chart)

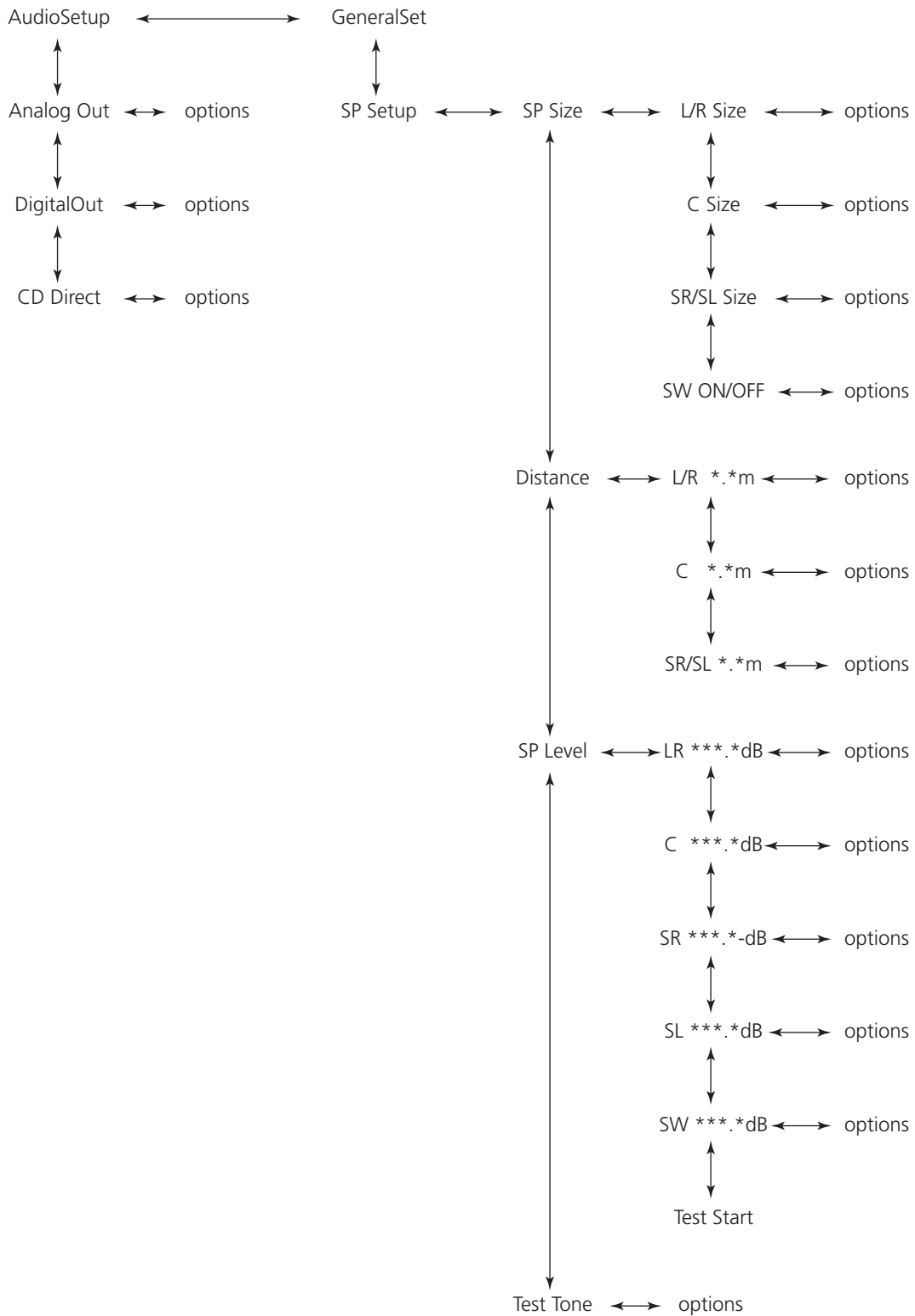

Settings (Audio Setup)

Analog output settings (Analog Out)

When an option marked with ">" is displayed, use the up or down cursor buttons to change the setting, and press the ENTER button to confirm the entry.

2ch

Outputs 2-channel audio from the the i.LINK (AUDIO) and the LINE OUT terminals.

If multi-channel program material is played, the multi-channel material will be downmixed to two channels.

Multi ch

The unit outputs the multi-channel surround sound.

Select this when the i.LINK (AUDIO) terminal is connected to a surround sound amplifier.

- Note that if "Multi ch" is selected, only the front L/R sound of the multi-channel material will be output from the LINE OUT terminals.
- This setting has no effect on the DIGITAL OUT terminals.

Digital output settings (DigitalOut)

When an option marked with ">" is displayed, use the up or down cursor buttons to change the setting, and press the ENTER button to confirm the entry.

ON

Audio is output from the i.LINK (AUDIO) terminal and the DIGITAL OUT terminals.

OFF

Audio is not output from the i.LINK (AUDIO) terminal and the DIGITAL OUT terminals. If you are not using these terminals, we suggest that you use this OFF setting for better analog sound.

- Digital sound from Super Audio CDs cannot be output from the DIGITAL OUT terminals.

CD Direct

When an option marked with ">" is displayed, use the up or down cursor buttons to change the setting, and press the ENTER button to confirm the entry.

Direct

Speaker setting is bypassed.

Normal

The speaker setting you have made is used.

Connect the i.LINK (AUDIO) terminal to an amplifier for this setting.

Settings (Speaker Setup 1)

Use these speaker setup menus when the i.LINK (AUDIO) terminal is connected to a surround sound amplifier, and when you don't use the speaker menus of the amplifier.

There is no need for this setup when not using the i.LINK (AUDIO) terminal, or when you use the speaker menus of the amplifier. In this case, leave this setup as it is (factory settings).

- This setup has an effect on the sound output from the i.LINK (AUDIO) terminal and the LINE OUT terminals when the Analog Out setting is set to "Multi ch".
- When the Analog Out setting is set to "2ch", the SP Size and Distance setting are ignored.
- When the CD Direct is set to "Direct", the settings made here are ignored during playback of a CD.

Speaker Size (SP Size)

Select the size (Large* or Small) independently for the L/R (front pair of speakers), the C (center speaker) and the SR/SL (surround pair of speakers). Turn the subwoofer (SW) ON* or OFF (if you have no subwoofer).

Large

Select this when the connected speakers can fully reproduce bass frequencies.

Small

Select this when the connected speakers are rather small and cannot reproduce bass frequencies.

When this setting is selected, bass frequencies are output from the subwoofer (if no subwoofer is connected, from the front speakers).

OFF

Select this when no speaker is connected. The sound is output from the front (or surround) speakers.

- When the front speaker is set to "Small", the subwoofer is set to "ON" automatically. You cannot set the subwoofer "OFF".

ON (subwoofer only)

Select this when a powered subwoofer is connected.

- For the center and surround pair options, if these speakers are not physically present, you can select OFF to prevent any output from those channels (you cannot turn off the front L/R pair). Any speakers turned off will downmix to the other enabled channels.

Speaker distance

This setup has no effect at the moment. Leave this setup as it is (factory settings)

When the SZ-1 is updated in the future, it will have an effect on the sound from DVD Audio discs.

Ideally, the speakers should be placed so that they are all the same distance from the listening position. If this is not possible, you should use this method described here to adjust them individually. It is also possible to adjust all distances together. The point of these settings is to provide the best synchronization between sound and image by delaying the sound by an appropriate amount. The subwoofer is not included in this setting (the placement of the subwoofer is less critical than that of other speakers).

The L/R setting changes the distance of all speakers together. Pressing the up button adds 0.1m to each value, and pressing the down button subtracts 0.1m from each value.

Distances are measured in meters (1 meter = just over 3 feet, and 0.1 meter = about 4 inches).

Carry out this operation first before setting the other speaker distances.

After setting the L/R, C and SR/SL speaker distances together, you can now set the center and surround pair distances. The minimum distance for these is 0m and the maximum is 9m, with the additional restrictions described here.

- The distance that you set for the center speaker cannot be greater than the distance set for the L/R pair and must be within 1.7m of that L/R distance.
So for example, if the distance to the L/R pair is set to 5.0m, the center distance must be between 3.3m (5 – 1.7) and 5m.
- The distance that you set for the SR/SL surround pair cannot be greater than the distance set for the L/R pair (and must be within 9m of that distance).
So with the L/R pair set at 5m, the SR/SL pair distance can be set from 0m to 5m.

Speaker levels (SP Level)

Use this to set the relative levels of the speakers. You can set the L/R pair together, and the center, and surround rear pair independently, as well as the subwoofer. The maximum value you can set here is 0dB and the minimum is –12dB, with settings made in 0.5dB increments. The default setting for each speaker channel is set to 0dB.

1. Select "Test Start" and press the ENTER button.

The unit outputs test tone from each channel in turn at the specified level for each channel.

- Adjust the master volume of your amplifier to the normal listening level.
- Test tone from subwoofer may be nearly inaudible. Check the level of subwoofer using an Super Audio CD which contains low frequency sound.
- The unit won't output test tone when "60958" is selected. Select "PCM" to use test tone (see page 14).
- The unit won't output test tone when an Super Audio CD disc is (or had been) loaded. In this case, remove the disc, turn the unit off and on, and try again.

2. Select a speaker using the up or down cursor buttons.

3. Press the right cursor button.

4. Adjust the levels using the up or down cursor buttons.

5. When the setting has been finished, press the SETUP button to exit the setup menu.

Test tone length (Test tone)

Select the Test Tone menu item, and choose between 2, 5* and 10 seconds. This represents the length of time that the test tone is output from each speaker when Test Start is selected.

In case you experience any problem with this unit, please take the time to look through this chart and see if you can solve the problem yourself before you call your dealer.

No power

- Check the connection to the AC power supply. Check and make sure the AC source is not a switched outlet and that, if it is, the switch is turned on. Make sure there is power to the AC outlet by plugging another item such as a lamp or fan.
- Press the STANDBY button of the main unit to turn it on.

Remote control doesn't work.

- Press the the ON button of the remote control unit (or the STANDBY button of the main unit) to turn it on.
- If the batteries are dead, change the batteries.
- Use remote control unit within the range (5m /15ft) and point at the front panel.
- Clear obstacles between the remote control unit and the main unit.
- If a strong light is near the unit, turn it off.

Severe hum or noise is heard.

- Place the unit as far away from a TV as possible.
- Make sure the line cords and speaker cables are as far away from the AC supply as possible.

Will not play.

- Reload the disc with the label side UP.
- This unit cannot play such discs as CD-ROMs. Use a playable disc (see page 5).
- If the disc is dirty, clean the surface of the disc.
- A blank disc has been loaded. Load a prerecorded disc.
- If the unit is condensed, leave the unit for one or two hours with the power turned on (see page 21).

Sound skips.

- Place the unit on a stable place to avoid vibration and shock.
- If the disc is dirty, clean the surface of the disc.
- Don't use scratched, damaged or warped discs.

There is no sound or only a very low-level sound is heard.

- Check that the amplifier and speakers are connected securely.
- Check the operation of the amplifier.
- Check the audio output setting (see page 19).
- When the amplifier is connected via the i.LINK (AUDIO) or the DIGITAL OUT terminal, set the Digital Out setting to "ON" (see page 19).
- The sound is muted during pause and fast forward/reverse. Press the PLAY button to resume normal playback.

No multi-channel audio output.

- Set the Analog Output setting to "Multi ch" (see page 19).
- Change the speaker configuration if necessary (see page 20).
- Super Audio CDs may have more than one playback area, not all of which contain multi-channel audio data. Choose a multi-channel area (see page 12).

Overall volume is low, or balance between speakers is strange.

- A speaker's level (or that of a pair of speakers) has been set up too low or too high in the speaker setup (see page 20). Correct the levels.

The speaker settings are ignored.

- Set the Analog Output setting to "Multi ch" (see page 19).
- Set the CD Direct to "Normal" (see page 19).

No digital audio output.

- Check that the Digital Out setting is set to "ON" (see page 19). When using the i.LINK (AUDIO) terminal, set the i.LINK output setting to "60958" or "PCM" (see page 14).
- Digital audio from a Super Audio CD cannot be output from the DIGITAL OUT terminals. Use the i.LINK (AUDIO) terminal.

The display shows "No Word!"

- The word sync mode is selected, but there is no clock source. Turn the word sync mode off (see page 14).
- No word clock is being received. Check cables, connections, and settings of the clock generator.

The display shows "WRD UNLCK!"

- Invalid word sync signal is received. Check the setting of the clock generator.

If normal operation cannot be obtained, unplug the power cord from the outlet and plug it again. This resets the internal micro-computer which can be disturbed during electrical storms, power interruptions, et cetera.

Beware of condensation

When the unit (or a disc) is moved from a cold to a warm place, or used after a sudden temperature change, there is a danger of condensation; vapor in the air could condense on the internal mechanism, making correct operation impossible. To prevent this, or if this occurs, leave the unit turned on for one or two hours. Then the unit will stabilize at the temperature of its surroundings.

Maintenance

If the surface of the unit gets dirty, wipe with a soft cloth or use diluted neutral cleaning liquid. Be sure to remove any fluid completely. Do not use thinner, benzene or alcohol as they may damage the surface of the unit.

Specifications

General

System	Super Audio CD and CD
Power supply	
Europe model	AC 230 V, 50 Hz
U.S.A./Canada model	AC 120 V, 60 Hz
Korea model	AC 220 V, 60 Hz
Power consumption	18 W (in standby mode: 1.5 W)
Weight	8.4 kg (18 1/2 lb)
External dimensions (W x H x D)	400 x 77 x 361 mm (15 3/4" x 3 1/16" x 14 3/16")
Operating temperature	+5°C - +35°C
Operating humidity	5% to 85% (no condensation)
Storage temperature	-20°C - +55°C

Audio output (Analog Audio)

Jacks	XLR jacks (2 channel) x 1 RCA jacks (2 channel) x 1
Maximum Output level (1 kHz, full scale)	RCA: 2.2 Vrms \pm 0.1 V/10 k Ω XLR: 2.2 Vrms \pm 0.1 V/10 k Ω
Frequency response	5Hz - 50 kHz (Super Audio CD, DSD setting: Normal) 5Hz - 80 kHz (Super Audio CD, DSD setting: Direct)
Signal-to-Noise Ratio (S/N)	130 dB
Dynamic range	107 dB
Total harmonic distortion	0.002%

Audio output (Digital Audio)

OPTICAL	Optical digital jack x 1, -15 to -21 dBm
COAXIAL	RCA jack x 1, 0.5 Vp-p/75 Ω

Word Synchronization input format

Jack	BNC
Input level	TTL level/75 Ω

The main unit can accept and synchronize to the following frequencies received from external devices:

44.1kHz, 88.2kHz, 100kHz, 176.4kHz (rectangular wave)

Accessories

Power cord	x 1
Remote Control Unit (RC-1055)	x 1
Batteries (AA, R6 or SUM-3)	x 2
Screwdriver	x 1
Felt	x 4
Warranty card	x 1
Owner's manual	x 1

- Design and specifications are subject to change without notice.
- Weight and dimensions are approximate.
- Illustrations may differ slightly from production models.

ESOTERIC

TEAC ESOTERIC COMPANY	3-7-3, Nakacho, Musashino-shi, Tokyo 180-8550, Japan Phone: (0422) 52-5132 e-mail: eso-os@tec.teac.co.jp
TEAC AMERICA, INC.	7733 Telegraph Road, Montebello, California 90640 Phone: (323) 726-0303
TEAC CANADA LTD.	5939 Wallace Street, Mississauga, Ontario L4Z 1Z8, Canada Phone: (905) 890-8008
TEAC MEXICO, S.A. De C.V	Campesinos N°184, Colonia Granjas Esmeralda, Delegacion Iztapalapa, CP 09810, México DF Phone: (525) 581-5500
TEAC UK LIMITED	Unit 19 & 20, The Courtyards, Hatters Lane, Watford, Hertfordshire, WD18 8TE , U.K. Phone: (0845) 130-2511
TEAC EUROPE GmbH	Bahnstrasse 12, 65205 Wiesbaden-Erbenheim, Germany Phone: 0611-71580
TEAC ITALIANA S.p.A.	Via C. Cantù 9/A, 20092 Cinisello Balsamo, Milano, Italy Phone: 02-66010500

This appliance has a serial number located on the rear panel. Please record the model number and serial number and retain them for your records.

Model number _____

Serial number _____

1205-MA-1032A

Free Manuals Download Website

<http://myh66.com>

<http://usermanuals.us>

<http://www.somanuals.com>

<http://www.4manuals.cc>

<http://www.manual-lib.com>

<http://www.404manual.com>

<http://www.luxmanual.com>

<http://aubethermostatmanual.com>

Golf course search by state

<http://golfingnear.com>

Email search by domain

<http://emailbydomain.com>

Auto manuals search

<http://auto.somanuals.com>

TV manuals search

<http://tv.somanuals.com>