

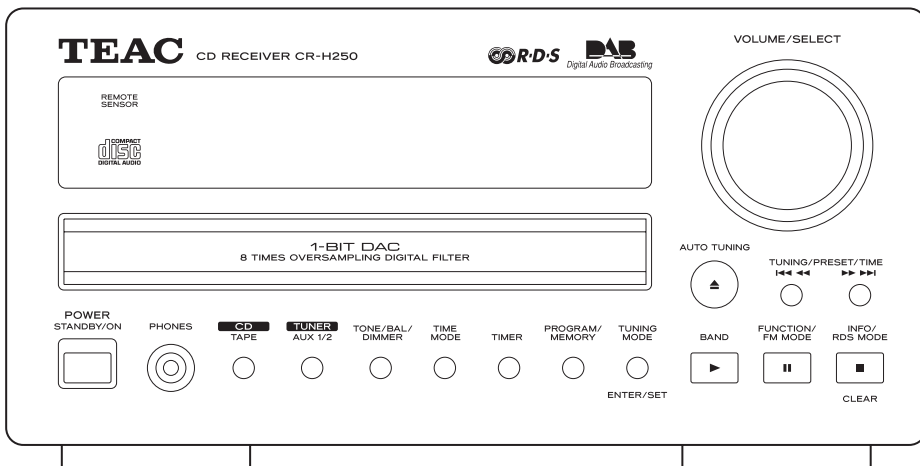

CR-H250

CD/Receiver Micro-System

OWNER'S MANUAL



Contents

Thanks you for choosing TEAC. Read this manual carefully to get the best performance from this unit.

Before Use	2
Compact Disc	3
Connections	4
Connecting Antennas (AM/FM)	6
Connecting Antennas (DAB)	7
Name of Each Control	8
Remote Control Unit	11
Basic Operation	12
Listening to CDs	14
Programmed Playback	16
Shuffle Playback	17
Repeat Playback	18
Time Display	19
Listening to the External Sources	19
Setting up your DAB Tuner	20
Auto Tuning	20
Using the Channel List	21
Using Function Control	22
Station order	22
Sig error rate	23
Preset tune	24
Sw version	24
DRC value	25
Manual tune	26
Changing Display Settings	27
Listening to FM/AM	28
Preset Tuning	29
RDS	31
PTY Search	32
About DAB	33
Setting the Clock	34
Setting the Timer	35
Sleep Timer	36
How to Reset the Settings to the Factory Defaults	36
Specifications	37
Troubleshooting	38

Before Use

Read this before operation

- As the unit may become warm during operation, always leave sufficient space around the unit for ventilation.
- The voltage supplied to the unit should match the voltage as printed on the rear panel. If you are in any doubt regarding this matter, consult an electrician.
- Choose the installation location of your unit carefully. Avoid placing it in direct sunlight or close to a source of heat. Also avoid locations subject to vibrations and excessive dust, heat, cold or moisture.
- Do not place the unit on an amplifier/receiver.
- Do not open the cabinet as this might result in damage to the circuitry or electrical shock. If a foreign object should get into the set, contact your dealer or service agency.
- When removing the power plug from the wall outlet, always pull directly on the plug, never yank the cord.
- To keep the laser pickup clean, do not touch it, and do not forget to close the disc tray when not using the CD player.
- Do not attempt to clean the unit with chemical solvents as this might damage the finish. Use a clean, dry cloth.
- Keep this manual in a safe place for future reference.

DO NOT MOVE THE UNIT DURING PLAYBACK

During playback, the disc rotates at high speed. Do NOT lift or move the unit during playback. Doing so may damage the disc.

WHEN MOVING THIS UNIT

When changing places of installation or packing the unit for moving, be sure to remove the disc and return the disc table to its original position in the player. Then, press the power switch to turn the power off, and disconnect the power cord. Moving this unit with the disc loaded may result in damage to this unit.

CAUTION

The product shall not be exposed to dripping or splashing and that no object filled with liquids, such as vases, shall be placed on the product.

Do not install this equipment in a confined space such as a book case or similar unit.

Compact Disc

Discs which can be played on this unit:

- Conventional audio CDs bearing the CD-DA logo on the label:



- Properly finalized CD-R and CD-RW discs

Note:

- Depending on the quality of the disc and/or the condition of the recording, some CD-R/CD-RW discs may not be playable.
- Copy-protected discs and other discs which do not conform to the CD standard may not play back correctly in this player. If you use such discs in this unit, TEAC Corporation and its subsidiaries cannot be responsible for any consequences or guarantee the quality of reproduction. If you experience problems with such non-standard discs, you should contact the producers of the disc.
- Always place the disc on the disc tray with the label side uppermost. (Compact discs can be played or recorded only on one side.)
- To remove a disc from its storage case, press down on the center of the case and lift the disc out, holding it carefully by the edges.



How to remove the disc How to hold the disc

- Should the disc become dirty, wipe the surface radially (from the center hole outward towards the outer edge) with a soft, dry cloth:



- Never use such chemicals as record sprays, antistatic sprays or fluid, benzine or thinner to clean the discs. Such chemicals will do irreparable damage to the disc's plastic surface.

- Discs should be returned to their cases after use to avoid dust and scratches that could cause the laser pickup to 'skip'.
- Do not expose discs to direct sunlight or high humidity and temperature for extended periods. Long exposure to high temperatures will warp the disc.
- Do not play any disc that is warped, deformed or damaged. Playing such discs may cause irreparable harm to the playing mechanisms.
- CD-R and CD-RW discs are more sensitive to the effects of heat and ultraviolet rays than ordinary CDs. It is important that they are not stored in a location where direct sunlight will fall on them, and which is away from sources of heat such as radiators or heat-generating electrical devices.
- Printable CD-R and CD-RW discs aren't recommended, as the label side might be sticky and damage the unit.
- Do not stick papers or protective sheets on the discs and do not use any protective coating spray.
- Use a soft oil-based felt-tipped pen to write the information on the label side. Never use a ball-point or hard-tipped pen, as this may cause damage to the recorded side.
- Never use a stabilizer. Using commercially available CD stabilizers with this unit will damage the mechanisms and cause them to malfunction.
- Do not use irregular shape CDs (octagonal, heart shaped, business card size, etc.). CDs of this sort can damage the unit:

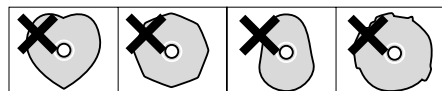

- If you are in any doubt as to the care and handling of a CD-R/CD-RW disc, read the precautions supplied with the disc, or contact the disc manufacturer directly.

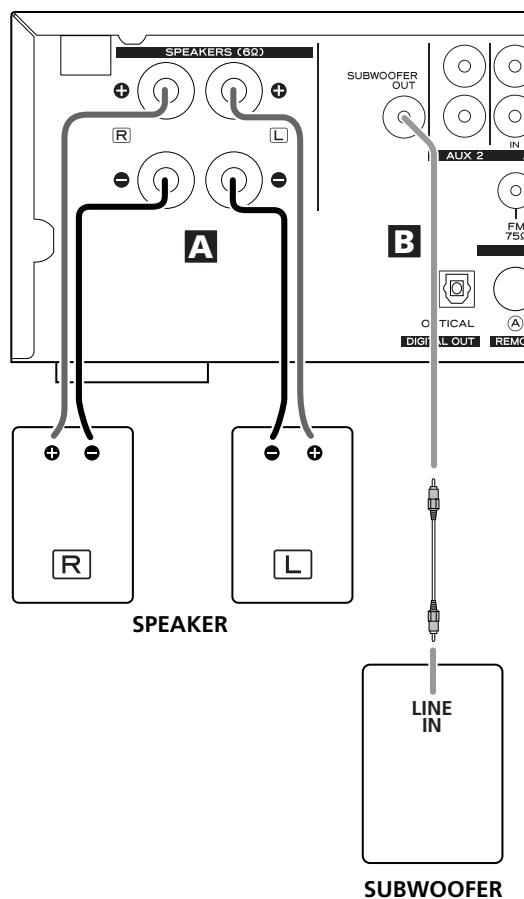

CAUTION

- Turn off the power of all the equipment before making connections.
- Read instructions of each component you intend to use with this unit.
- Be sure to insert each plug securely. To prevent hum and noise, do not bundle the connection cords with the power cord or speaker cord.

A Speaker Connections

Caution:

- To avoid damaging the speakers by inputting a sudden high-level signal, be sure to switch the power off before connecting the speakers.
- Check the impedance of your speakers. Connect speaker with an impedance of 6 ohms or more.
- The amplifier's red speaker terminals are the ⊕ (positive) terminals and the black terminals are the ⊖ (negative) terminals.
The ⊕ side of the speaker cable is marked to make it distinguishable from the negative side of the cable. Connect this marked side to the red ⊕ terminal and the unmarked side to the black ⊖ terminal.
- Prepare the speaker cords for connection by stripping off approximately 10 mm or less (no more as this could cause a short-circuit) of the outer insulation. Twist the wires tightly together to avoid tangles:

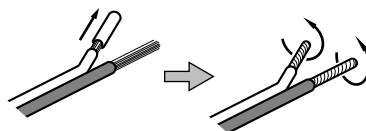

How to connect

1. Turn the terminal cap counterclockwise to loosen it. The speaker terminal caps cannot be fully removed from the base.
2. Insert the wire into the terminal fully and turn the terminal cap clockwise to securely connect it:

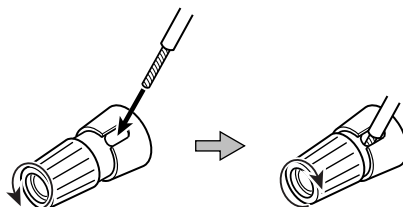

3. Make sure it is fastened firm by pulling the cable lightly.

B SUBWOOFER OUT jack

Connect a commercially available powered subwoofer.

- Subwoofer output will not be cut off, when the headphone jack is inserted.

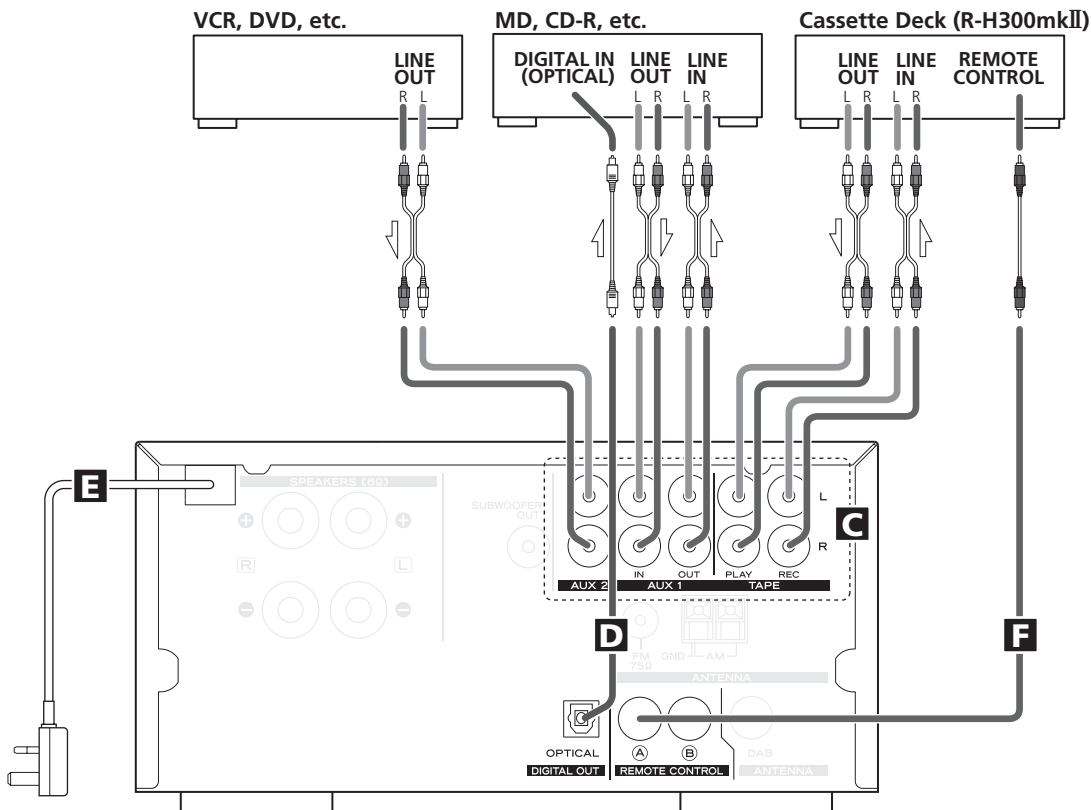

C TAPE/AUX jacks

Make sure to connect:

- white plug → white jack (L: left channel)
- red plug → red jack (R: right channel)

- Be sure to insert each plug securely. To prevent hum and noise, do not bundle the connection cords with the power cord or speaker cord.

D DIGITAL OUT terminal

Connect the component with an optical cable.

DIGITAL OUT → DIGITAL IN (MD, etc.)

- When inserting the plug of the optical cable, the protective shutter of the terminal will open and you should hear it click into position when fully inserted. Be careful that you do not force the plug, because this could result in damage to the protective shutter, the cable, or the unit itself.

E AC Power Cord

Plug this AC power cord into an AC wall socket.

F REMOTE CONTROL jack

- You can use the system remote control unit RC-956 (provided with this unit) to operate TEAC R-H300mkII.

Connect the REMOTE CONTROL jack (A or B) to the REMOTE CONTROL jack (A or B) of R-H300mkII with the remote control connection cord.

Note:

The remote control connection cord is not provided with this unit.

Connecting Antennas (AM/FM)

AM Indoor Loop Antenna

The high-performance AM loop antenna provided with this unit is sufficient for good reception in most areas.

To stand the loop antenna on a surface, fix the claw to the slot in the antenna base.

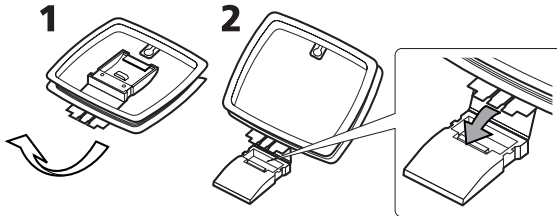

Connect the loop antenna's wires to the AM antenna terminals.

Place the antenna on a shelf or hang it on a window frame, etc., in the direction which gives the best reception. Keep all other wires such as power cords, speaker wires or interconnect wires as far away from the antenna.

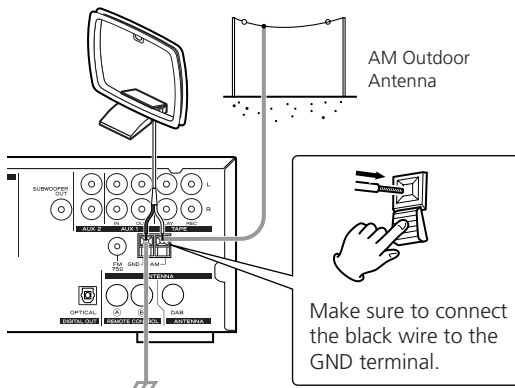

- If the AM loop antenna provided does not deliver sufficient reception (often due to being too far from the transmitter or in a concrete building, etc.), it may be necessary to use an outdoor AM antenna. Use either a high quality commercial AM antenna or, if not available, an insulated wire more than 5 m long, strip one end, and connect this to the terminal as shown.

The antenna wire should be strung outdoors or indoors near a window. For better reception, connect the GND terminal to a reliable ground.

Note:

Even when using an outdoor AM antenna, do not disconnect the AM loop antenna.

FM Indoor Antenna

Connect the lead-type FM antenna to the FM 75Ω socket, extend the lead and tune the tuner to your favorite station (see page 28). Adjust the antenna in a suitable location like a window frame or wall until the reception is best and then affix the antenna in that position using thumb tacks, push pins or any other suitable means.

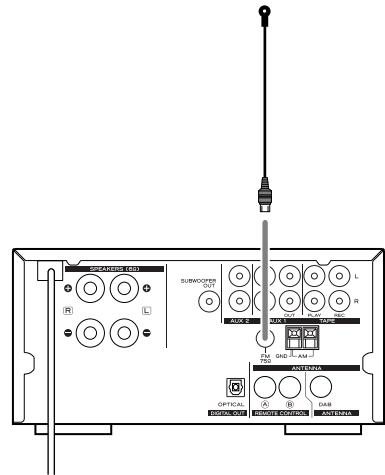

FM Outdoor Antenna

In an area where FM signals are weak, it will be necessary to use an outdoor FM antenna. Generally, a 3-element antenna will be sufficient; if you live in an area where the FM signals are particularly weak, it may be necessary to use one with 5 or more elements.

- Disconnect the FM indoor antenna when using an outdoor antenna.

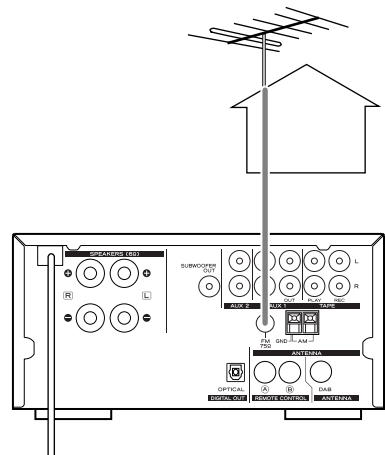

Connecting Antennas (DAB)

DAB Indoor Antenna

Connect the T-type DAB antenna to the DAB socket, extend the lead vertically and attach it to a window frame or wall with thumbtacks, or the like, where reception is best.

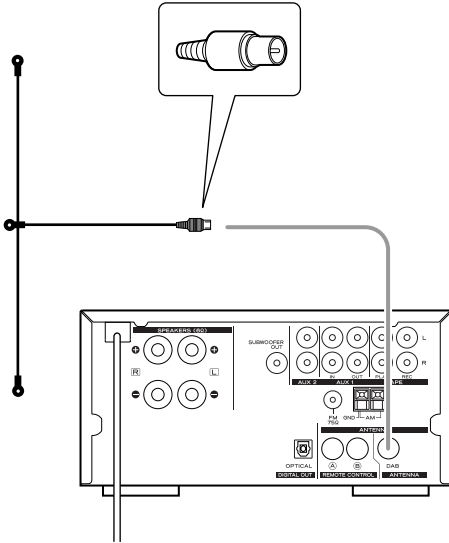

- You can check the antenna adjustment or positioning for the best reception by viewing the signal strength on the display.

The signal strength is displayed as a bar graph by pressing the ENTER button once.

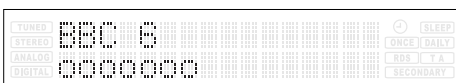
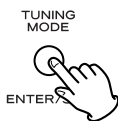

DAB Outdoor Antenna

In an area where DAB signals are weak, it will be necessary to use an outdoor DAB antenna. There are two main types available.

Dipole:

For use in marginal signal areas. This type of antenna is omnidirectional and should increase the strength of all DAB stations being received.

Multi-element antenna:

Also for use in marginal or poor signal areas. This type of antenna is directional and has high gain. This antenna needs to be pointed at the transmitter you want to listen to.

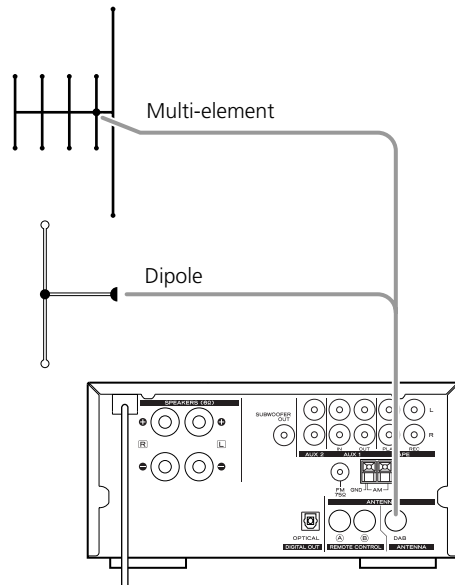

- It is possible to use a TV or FM antenna with your DAB tuner as this is normally mounted externally. This may give a stronger signal than a simple internal antenna, however it would not be tuned specifically for DAB reception.

You would need to change the plug on your TV/FM antenna to an F type, and it may also be necessary to use a signal booster to enhance the signal.

Names of Each Control 1

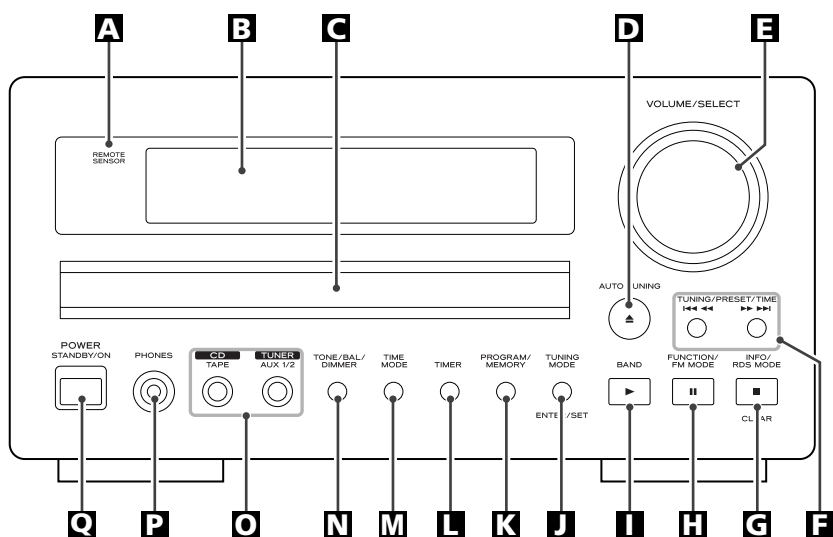

A Remote Sensor

When operating the remote control unit, point it towards the remote sensor.

B Display

C Disc tray

D OPEN/CLOSE (▲), AUTO TUNING

In CD mode, use this button to open and close the disc tray.

In DAB mode, press this button to activate auto location of all available DAB services. Press once for UK services or, hold for longer than 2 seconds to activate international search.

E VOLUME, SELECT

Turn this knob to adjust the volume.

Turn this knob to adjust the tone, balance and dimmer together with the TONE/BAL/DIMMER button.

F SKIP (◀◀◀/▶▶▶), TUNING, PRESET, TIME

In CD mode, use these buttons to skip tracks.

In TUNER mode, use these buttons to tune in stations or select the preset stations.

While setting the clock or the timer, use these buttons to adjust the time.

G STOP (■), INFO, RDS MODE, CLEAR

In CD mode, use this button to stop playback.

In DAB mode, this button is used to change the text content on the second line of the display, to show DLS (Dynamic Label Segment, info text supplied by each radio station), Programme type (classification given by the radio station ie: Pop music or Rock), Multiplex name (name of multiplex broadcaster), Time & date, Bitrate, or Channel and frequency.

In FM mode, this button is used to select the RDS mode.

Also use this button to cancel the entering or modes.

H PAUSE (II), FUNCTION, FM MODE

In CD mode, use this button to pause playback.

In DAB mode, activates features such as station order, manual tune, DRC value, SW version indication, signal error rate. It is also possible to 'tidy' the station list to remove stations which are in the memory but have no service provided.

In FM mode, use this button to select stereo or monaural.

I PLAY (▶), BAND

In CD mode, use this button to start playback.

In TUNER mode, use this button to select FM, AM or DAB.

J TUNING MODE, ENTER/SET

In FM or AM mode, use this button to select the tuning mode.

In DAB mode, use this button to enter the selection.

While setting the timer or the clock, use this button to set the time.

K PROGRAM, MEMORY

In CD mode, use this button to enter the program mode. In program mode, use this button to enter the selection.

In TUNER mode, use this button to memory the station manually.

L TIMER

Use this button to turn on or off the timer function.

M TIME MODE

Use this button to adjust clock and to set timer.

N TONE, BAL, DIMMER

Use this button to adjust the tone, balance and dimmer together with the VOLUME/SELECT knob.

O Input selector

Use these buttons to select a source.

P PHONES

For private listening, insert the headphones plug into this jack, and adjust the volume by turning the VOLUME/SELECT knob.

Q POWER

Press this button to turn the unit on or standby.

The standby indicator lights when the unit is in the standby mode. When the unit is turned on, it goes off.

The equipment draws nominal non-operating power from the AC outlet with its POWER switch in the STANDBY position.

If the R-H300mkII is connected to the CR-H250 with a remote control cord, you can switch ON/standby both the CR-H250 and the R-H300mkII by pressing the POWER button of the CR-H250.

Names of Each Control 2

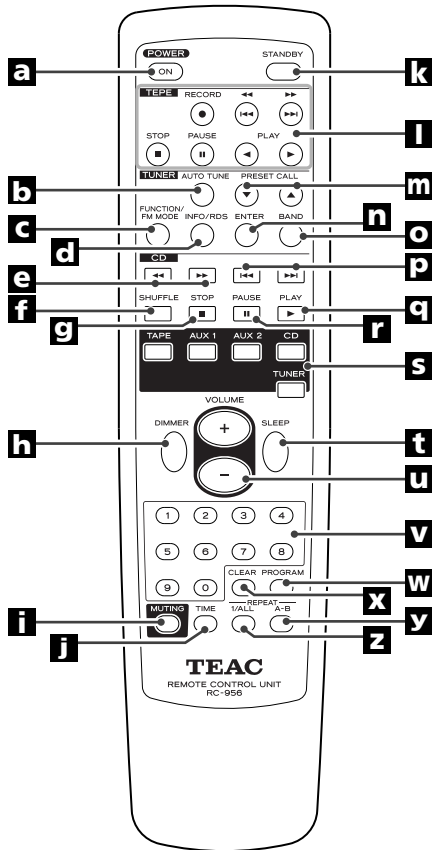

a POWER ON

Press this button to turn the unit on.

b AUTO TUNE

In DAB mode, press this button to activate auto location of all available DAB services. Press once for UK services or, hold for longer than 2 seconds to activate international search.

c FUNCTION, FM MODE

In DAB mode, activates features such as station order, manual tune, DRC value, SW version indication, signal error rate. It is also possible to 'tidy' the station list to remove stations which are in the memory but have no service provided. In FM mode, use this button to select stereo or monaural.

d INFO, RDS

In DAB mode, this button is used to change the text content on the second line of the display, to show DLS (Dynamic Label Segment, info text supplied by each radio station), Programme type (classification given by the radio station ie: Pop music or Rock), Multiplex name (name of multiplex broadcaster), Time & date, Bitrate, or Channel and frequency.

In FM mode, this button is used to select the RDS mode.

e SEARCH (◀/▶)

During playback of CD, use these buttons to search the part you want to listen to.

f SHUFFLE

In CD mode, use this button to enter the shuffle playback mode.

g STOP

In CD mode, use this button to stop playback.

h DIMMER

Use this button to dim the display.

i MUTING

Use this button to mute the sound.

j TIME

In CD mode, use this button to change the time display.

k STANDBY

Press this button to turn the unit to stanby mode.

l Buttons for the operation of TEAC R-H300mkII (TAPE).

m PRESET CALL

In TUNER mode, use these buttons to select the preset stations.

n ENTER

In DAB mode, use this button to enter the selection.

Remote Control Unit

B BAND

In TUNER mode, use this button to select FM, AM or DAB.

P SKIP (◀◀/▶▶)

In CD mode, use these buttons to skip tracks.

Q PLAY (▶)

In CD mode, use this button to start playback.

R PAUSE (||)

In CD mode, use this button to pause playback

S Input selector

Use these buttons to select a source.

T SLEEP

Use this button to set the sleep timer.

U VOLUME

Use these buttons to adjust the volume.

V Numeric buttons

Use these buttons to select a track number or a preset channel.

Press the CD or TUNER button to select the mode, and then press the numeric buttons.

For instance, to select track number 35, first press the CD button, and then press '3' and '5'.

To select numbers less than 10, press '0' and then the number. As an example, to select number 5, press '0' and '5'. (Optionally, you may press just the number '5' and then wait a few seconds.)

W PROGRAM

In CD mode, use this button to enter the program mode. In program mode, use this button to enter the selection.

X CLEAR

Use this button to cancel the entering or modes.

Y REPEAT A-B

Use this button to set the point for A-B repeat.

Z REPEAT 1/ALL

Use this button to select the repeat mode.

The provided Remote Control Unit allows the unit to be operated from a distance.

When operating the remote control unit, point it towards the REMOTE SENSOR on the front panel of the unit.

- Even if the remote control unit is operated within the effective range, remote control operation may be impossible if there are any obstacles between the unit and the remote control.
- If the remote control unit is operated near other appliances which generate infrared rays, or if other remote control devices using infrared rays are used near the unit, it may operate incorrectly. Conversely, the other appliances may operate incorrectly.

Battery Installation

1. Remove the battery compartment cover.
2. Insert two 'AAA' dry batteries. Make sure that the batteries are inserted with their positive '⊕' and negative '⊖' poles positioned correctly.
3. Close the cover.

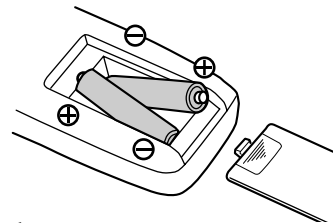

Battery Replacement

If the distance required between the remote control unit and main unit decreases, the batteries are exhausted. In this case replace the batteries with new ones.

Precautions concerning batteries

- Be sure to insert the batteries with correct positive '⊕' and negative '⊖' polarities.
- Use batteries of the same type. Never use different types of batteries together.
- Rechargeable and non-rechargeable batteries can be used. Refer to the precautions on their labels.
- When the remote control unit is not to be used for a long time (more than a month), remove the batteries from the remote control unit to prevent them from leaking. If they leak, wipe away the liquid inside the battery compartment and replace the batteries with new ones.
- Do not heat or disassemble batteries and never dispose of old batteries by throwing them in a fire.

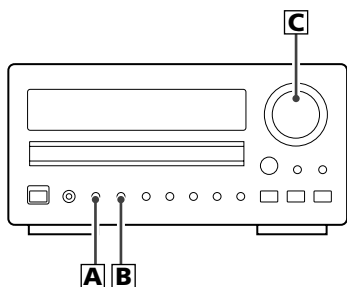

A How to select CD/TAPE

Every time the CD/TAPE button is pressed, the mode is changed as follows:

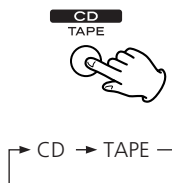

B How to select TUNER/AUX 1/2

Every time the TUNER/AUX 1/2 button is pressed, the mode is changed as follows:

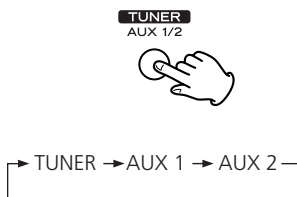

Or press the CD, TAPE, AUX 1/2 or TUNER button on the remote control unit to select the source directly.

C Adjust the volume

To protect speakers from a sudden high-level signal, gradually turn up the volume to the required level with the VOLUME knob.

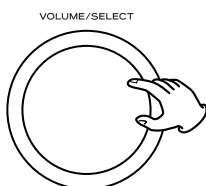

D Muting

To cut the sound temporarily, press the MUTING button. Press any button to restore the sound.

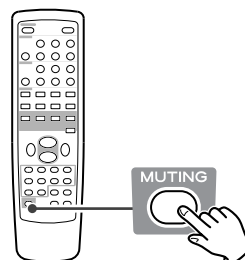

E Dimmer (remote control)

Press the DIMMER button to dim the display. Press the button again to cancel the dimmer function.

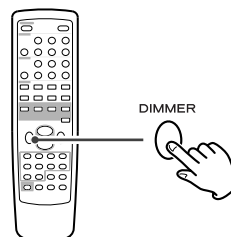

- This function will be cancelled when the unit is turned off.
- If the R-H300mkII is connected to this unit with a remote control cord, the display of both will be dimmed.

F Listening through headphones

Insert the headphone plug into the PHONES jack, and adjust the volume. The sound from speakers will be cut off.

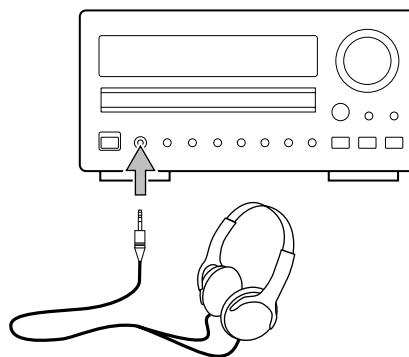

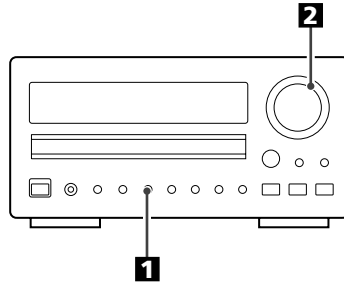

How to adjust TONE/BALANCE/DIMMER

1 Press the TONE/BAL button.

Each time the TONE/BAL button is pressed, the mode is changed as follows:

TONE/BAL/
DIMMER

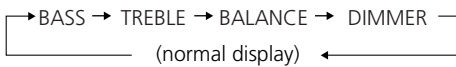

2 Within 3 seconds, turn the VOLUME/SELECT knob to change the setting.

VOLUME/SELECT

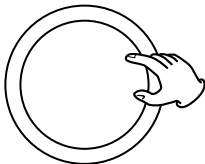

Bass control

This control is used for adjusting the level of the low frequency sound range.

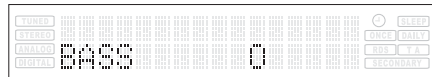

Treble control

This control is used for adjusting the level of the high frequency sound range.

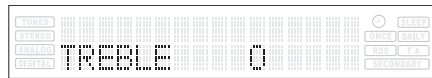

Balance control

This control is used for adjusting balance of the volume level between the left and right channels.

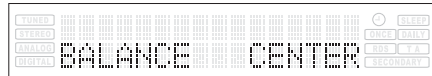

Dimmer control

This control can be used to dim the display panel or to return it to normal.



Listening to CDs

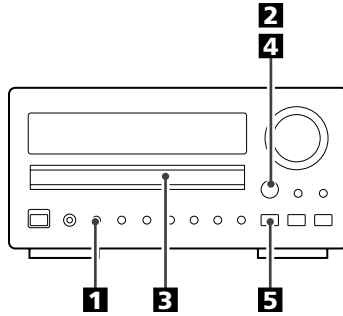

- 1** Press the CD/TAPE button to select 'CD'.
'No Disc' will be displayed if no disc is set.

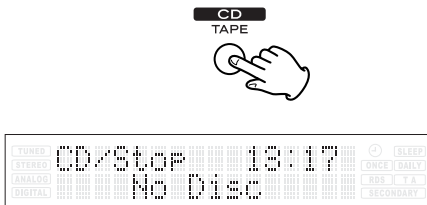

- 2** Press the OPEN/CLOSE button (▲).



- 3** Place a disc on a tray with the printed surface up.

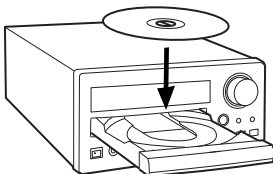

- 4** Press the OPEN/CLOSE button (▲) to close the tray.

The total number of the tracks and total play time of the disc is displayed.

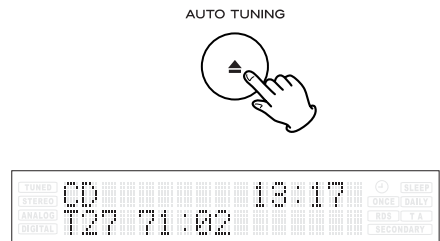

- 5** Press the ► (PLAY) button.

Playback starts from the first track.

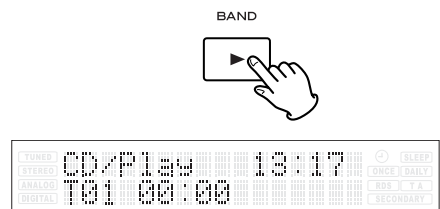

- When a disc is set on the disc tray, pressing the CD button will start playback.
- If the source is set to 'CD', the unit will automatically start playback when you turn on the unit next time.

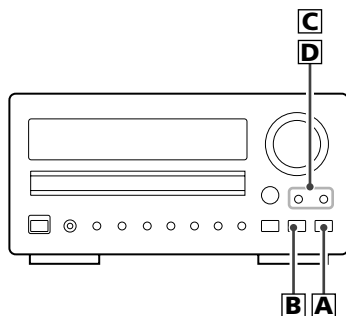

A To stop playback

Press the ■ (STOP) button to stop playback.

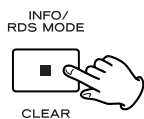

B To suspend playback temporarily (pause mode)

Press the || (PAUSE) button. Playback stops at the current position.

To resume playback, press the ► (PLAY) button or || (PAUSE) button.



C To skip to the next or a previous track

Press the ◀◀◀ or ▶▶▶ button several times until the desired track is found. The selected track will be played from the beginning.

On the remote control press the ◀◀ or ▶▶ (SKIP) button.

- When the ◀◀◀ button is pressed once during playback, the track being played will be played from the beginning.

To return to the beginning of the previous track, press the ◀◀◀ button twice.



D Search for a part of a track

During playback, hold down the ◀◀◀ or ▶▶▶ button and release it when the part you want to listen to is found.

On the remote control use the ◀◀ or ▶▶ button.



E Direct Playback

While in stop or playback mode, you can use the numeric buttons of the remote control unit to select a track.

Press the numeric buttons to select a track. Playback starts from the selected track.

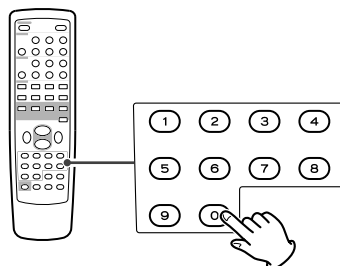

For instance, to select track number 35, press '3' and '5'.

To select numbers less than 10, press '0' and then the number. As an example, to select number 5, press '0' and '5'. (Optionally, you may press just the number '5' and then wait a few seconds.)

Programmed Playback

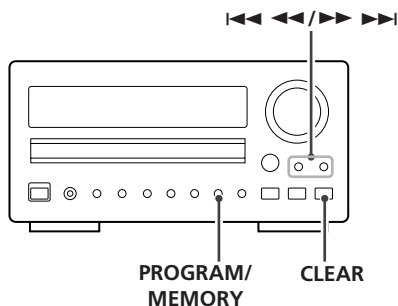

- This function allows you to program up to 32 tracks for playback in any desired order.

1 Press the PROGRAM/MEMORY button in the stop mode.

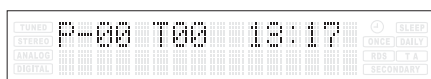

2 Select the desired track by pressing the **◀◀** or **▶▶** (SKIP) button and press the PROGRAM/MEMORY button to enter.

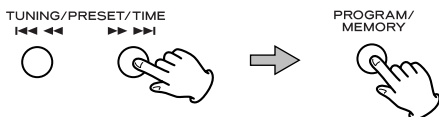

Repeat this step to store other tracks.

- If you attempt to program more than 32 tracks, 'FULL' is displayed and no more can be programmed.

3 Press the **▶** (PLAY) button to start programmed playback.

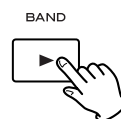

- The programmed contents are not lost even if the unit is turned off, but they are lost when the disc tray is opened.
- The unit will stop automatically when the playback of all the programmed tracks is finished, and the program contents disappears from the display, but they are not lost.
- To start program playback again, press the PROGRAM/MEMORY button and the PLAY button.

To check the programmed order

Press the PROGRAM/MEMORY button repeatedly in the stop mode. The track number and program number will be shown on the display.



To delete a track from the program

In the stop mode, press the PROGRAM button repeatedly until the program number to be deleted appears on the display, then press the CLEAR button. The selected track is deleted from the program.

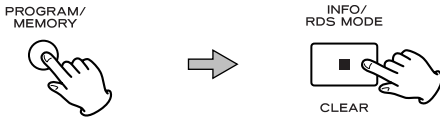

To clear the program

1. In the stop mode, press the PROGRAM/MEMORY button.
2. Hold down the CLEAR button for more than 2 seconds.

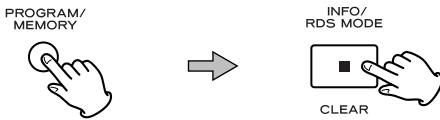

- If the OPEN/CLOSE button is pressed, the programmed contents will also be cleared.

To add a track to the program

In the stop mode, press the PROGRAM/MEMORY button repeatedly until the program number you want to insert a track appears on the display. If you want to add a track to the end of the program, press the PROGRAM button repeatedly until 'P-END' briefly appears on the display.

Then select a track number pressing the ◀◀ or ▶▶ (SKIP) buttons and press the PROGRAM/MEMORY button to enter. The track is added to the program.

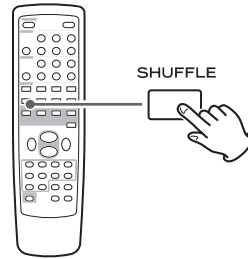
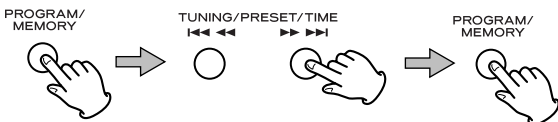

Press the SHUFFLE button in the stop or play mode.

The tracks will be played randomly.

- If you press the SKIP button (▶▶) during shuffle playback, next track will be randomly selected and played. If you press the SKIP button (◀◀), the currently played track will be played from the beginning. A track cannot be replayed during shuffle playback.
- To stop shuffle playback, press the SHUFFLE or STOP (■) button.

Repeat Playback

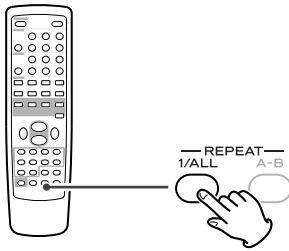

Every time the REPEAT 1/ALL button is pressed, the mode is changed as follows:

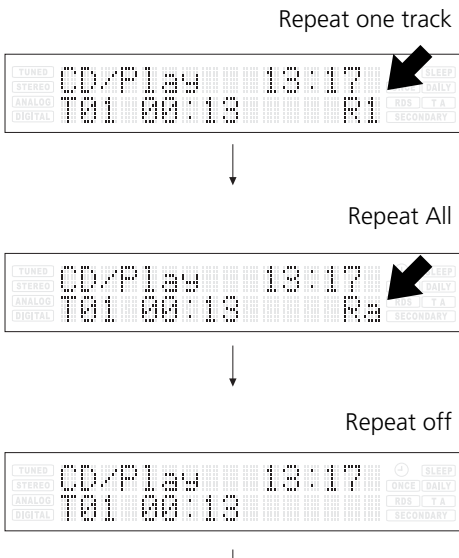

Repeat one track [R1]

The track being played will be played repeatedly. If you select another track in R1 mode, the track you selected will be played repeatedly.

Repeat All [Ra]

All the tracks of the selected disc will be played repeatedly.

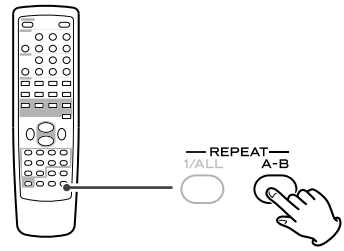

Repeat A-B

This function allows repeat playback of any desired portion of the disc.

1. Designate the point at which repeat playback should start by pressing the A-B button. 'Rs' blinks.
 2. When the point at which repeat playback should end is reached, press the A-B button again. 'Rs' lights up.
 3. The designated point with A-B button will be played back repeatedly.
- To return to normal play, press A-B button until 'Rs' disappears from the display.



Setting up your DAB Tuner

The first time you listen to the DAB radio, it will scan for DAB channels and build a channel list.

To enter the DAB mode, turn the unit on, and select DAB by pressing the TUNER/AUX 1/2 button and the BAND button.

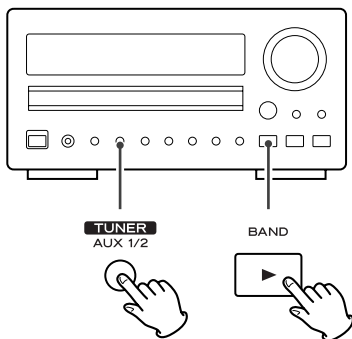

The following screen will display for 2 seconds.

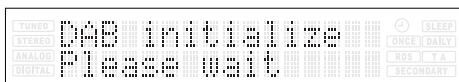

The unit will scan for broadcast services in the local area and add them to the channel list as they are found. The scan should take about 10 seconds.

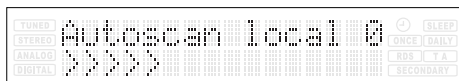

As channels are added to the channel list the number of channels found is displayed.



After broadcast services have been found the channels are listed in alphanumeric order.

- If no broadcast services are found, please check that the antenna is correctly connected to the unit.

Auto Tuning

If you move the unit to a new area or you want to check to see if there are new channels available in your area, you can scan to find new channels automatically.

Press the AUTO TUNING button.

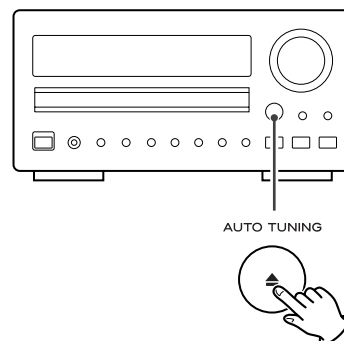

The unit will scan for any new channels and add the channels found to the channel list.

- Press and hold the AUTO TUNING button for longer than 2 seconds to activate international search.

Using the Channel List

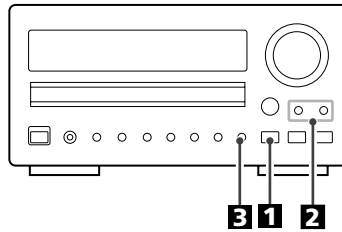

Follow the steps below to tune in and listen to the channels found by the unit.

1 Select DAB by pressing the BAND button.

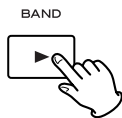

2 Press the TUNING/PRESET/TIME button to find the channel in the channel list.



The current channel is displayed on the first line and the changing list is displayed on the second line.

3 When you have found a channel that you want to listen to, press the ENTER button once.



The channel is tuned in and channel information is displayed.

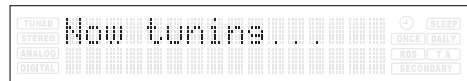

- To display the signal strength of a channel, press the ENTER button again. The signal strength is displayed. Press the ENTER button once again to cancel the signal strength display.
- Channels are displayed in alphanumeric order in the channel list, with numbers coming first. So, stations such as 6 Music from the BBC will be listed early in the list.
- If a channel is no longer broadcasting or the unit is moved out of the area of a broadcast channel, the unit will no longer be able to tune in the channel. If the channel cannot be tuned in a question mark (?) is displayed in front of the channel name. If you select this channel to tune in by pressing the ENTER button, 'No stations Available' is displayed.
- You can remove a channel that is no longer available from the channel list. See Tidy station, page 23.

Using Function Control 1

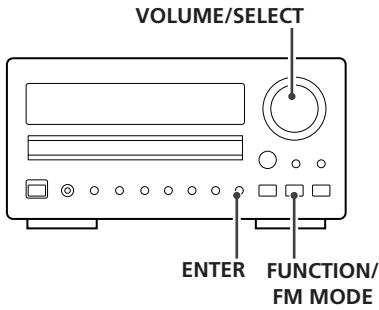

In DAB mode, use Function Control to set system options. There are 6 options in the function control.

- Station order
- Signal error rate
- Preset tune
- Software version
- DRC value
- Manual tune

Station order

Use station order to set the order in which stations are listed. There are four orders: Favourite, Alphanumeric, Active and Tidy.

- 1** While listening to a DAB broadcast press the **FUNCTION/FM MODE** button.



- 2** Press the **TUNING/PRESET/TIME** button until 'Station order' is displayed in the second line of the display.

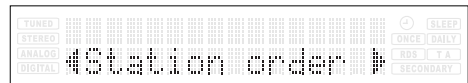
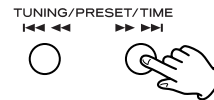

- 3** Press the **ENTER** button.

The current option is displayed in the first line of the display.

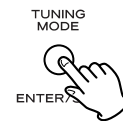

- 4** Press the **TUNING/PRESET/TIME** button until the desired option is displayed in the second line of the display.

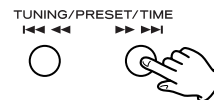

E Press the ENTER button.

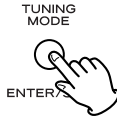

Fav Station (Favourite station)

As you tune in stations and listen to them the unit will memorize the top ten stations you listen to and list them at the top of the channel list. A Favourite station in the channel list has '♥' displayed after the station name on the first line of the display.

Alphanumeric

This is the default order. Channels are listed by name with numbers first and then alphabetically by letters in the channel name.

Active station

This option will list active stations at the top of the channel list and channels that are in the list but have no service in your area to be listed last in the channel list.

Tidy station

This option will list active stations and remove any channels that are in the list but have no service in your area from the channel list.

♥ → preset

This option takes your top ten Favourite channels and assigns them to preset numbers 1 - 10. This option is only available after 'Fav Station' option has been turned on. See above.

Sig error rate (Signal error rate)

This option shows the digital bit error rate (0-99) of the currently tuned channel. This is for information only and no adjustment is available. The lower the figure the better the quality of the received broadcast.

1 While listening to a DAB broadcast press the FUNCTION/FM MODE button.



2 Press the TUNING/PRESET/TIME button until 'Sig error rate' is displayed in the second line of the display.

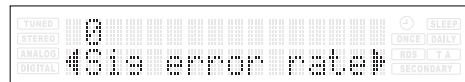
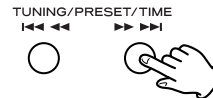

E Press the ENTER button.

The digital bit error rate of the current tuned channel is displayed.



Using Function Control 2

Preset tune

Use this option to select the DAB preset station.

- 1 While listening to a DAB broadcast press the **FUNCTION/FM MODE** button.



- 2 Press the **TUNING/PRESET/TIME** button until 'Preset tune' is displayed in the second line of the display.



- 3 Press the **ENTER** button.



The currently tuned station is displayed.

- 4 Press the **TUNING/PRESET/TIME** button until the desired preset station is displayed.



- 5 Press the **ENTER** button to select the preset station.

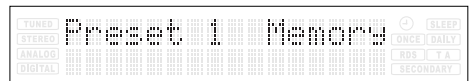
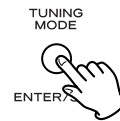

Sw version (Software version)

This option shows the version number of the installed software. This is for information only and no adjustment is available.

- 1 While listening to a DAB broadcast press the **FUNCTION/FM MODE** button.



- 2 Press the **TUNING/PRESET/TIME** button until 'Sw version' is displayed in the second line of the display.

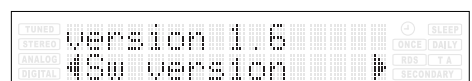

DRC value

This option sets the Dynamic Range Control (DRC) value to be applied to received broadcasts. DRC is used to reduce the range between high and low volumes of audio and is sometimes applied at the broadcast source. Pop music may have a high value of DRC applied, appropriate for constantly high listening levels, while classical music broadcasts may have no DRC applied to allow the listener to hear the full dynamic range of the source volume.

There are three values of DRC you can apply.

- 0 : None
- 1/2 : Medium
- 1 : Maximum

1 While listening to a DAB broadcast press the **FUNCTION/FM MODE** button.



2 Press the **TUNING/PRESET/TIME** button until 'DRC value' is displayed in the second line of the display

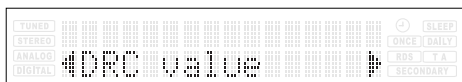

3 Press the **ENTER** button.

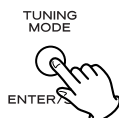

4 Press the **TUNING/PRESET/TIME** button until the desired level of DRC is displayed in the second line of the display.

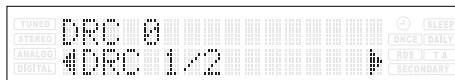
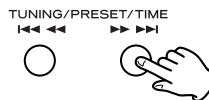

5 Press the **ENTER** button.



Using Function Control 3

Manual tune

This option allows you to manually tune in a channel and view a continuously updated display of the strength of the signal. This may be useful when adjusting or positioning an antenna for better reception.

- 1** While listening to a DAB broadcast press the **FUNCTION/FM MODE** button.



- 2** Press the **TUNING/PRESET/TIME** button until 'Manual tune' is displayed in the second line of the display.

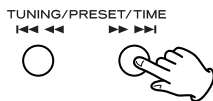

- 3** Press the **ENTER** button.



'Manual tune' is displayed on the first line of the display.

- 4** Press the **TUNING/PRESET/TIME** button to find the channel.



- 5** Press the **ENTER** button when the channel you wish to tune in is displayed in the second line of the display.

The signal strength indicator is displayed.

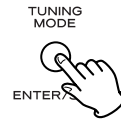

- 6** While viewing the indicator, adjust or reposition the antenna until the best reception is indicated.

- 7** Press the **ENTER** button to cancel Manual tune and resume normal reception.

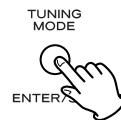

Changing Display Settings

You can choose the type of information displayed in the second line of the display while listening to a DAB channel.

Each time the INFO/RDS MODE button is pressed, the information is displayed as follows.

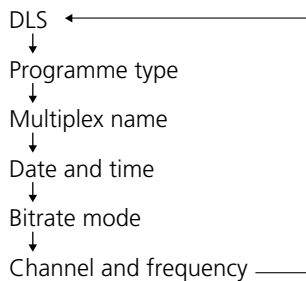
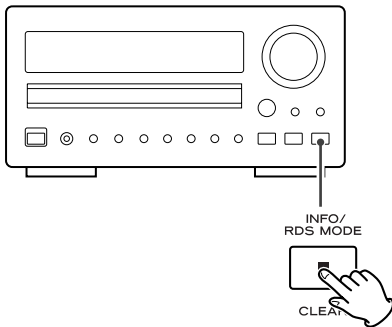

DLS

The Dynamic Label Segment (DLS) is the scrolling text label supplied by the radio station. It may be information on music titles or details regarding the programme or station.

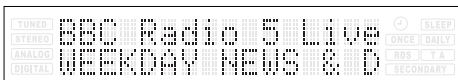

Programme type

This is a description of the type of broadcast supplied by the radio station such as Pop, Rock or Classical music.



Multiplex name

This displays the name of the Multiplex that is broadcasting the programme.

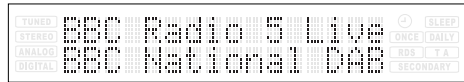

Date and time

This displays the current date and time, which is supplied by the radio station and should always be accurate.



- The clock setting will be automatically adjusted according to the clock time data.

If you tune in a DAB station broadcasting incorrect clock time data, the clock might be wrongly adjusted, and that may eventually affect the timer operation.

No matter which DAB mode is selected, the unit receives clock time data and adjusts the clock.

Bitrate mode

This displays the bitrate of the current playing broadcast.

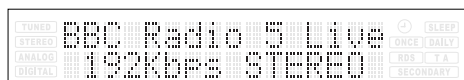

Channel and frequency

This displays the channel and frequency of the current playing broadcast.



Listening to FM/AM

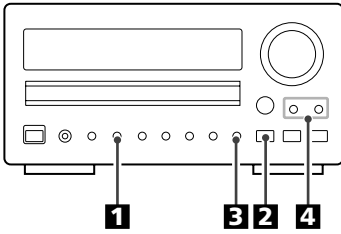

1 Press the TUNER/AUX 1/2 button to select 'TUNER'.



2 Press the BAND button to select FM or AM.

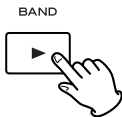

3 Press the TUNING MODE button to select the 'Auto tune' mode.



Each time the TUNING MODE button is pressed, the mode is changed as follows.

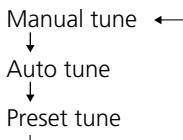

4 Select the station you want to listen to (auto selection).



When a station is tuned in, the tuning process will stop automatically.

If you want to stop the tuning process, press the TUNING/PRESET/TIME button.

Selecting stations which cannot be tuned automatically (Manual tune)

Select 'Manual tune' in step **3**.

Repeatedly press the TUNING/PRESET/TIME button until the station you want to listen to is found. Or hold down the TUNING/PRESET/TIME button until the station you want to listen to is found and release the button.

FM: 50 kHz steps, AM: 9 kHz steps

- 'STEREO' is displayed when a stereo broadcast is tuned in.
- 'TUNED' is displayed when a broadcast is correctly tuned in.

FM MODE Button

Pressing this button alternates between Stereo mode and Mono mode.

Stereo

FM stereo broadcasts are received in stereo and the STEREO indicator lights in the display.

Mono

To compensate for weak FM stereo reception, select this mode. Reception will now be forced monaural, reducing unwanted noise.

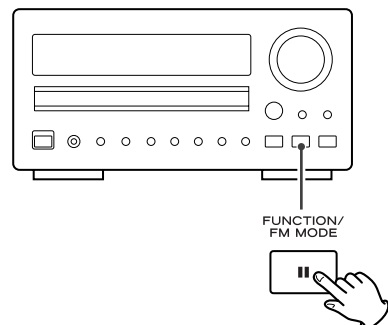

Preset Tuning 1

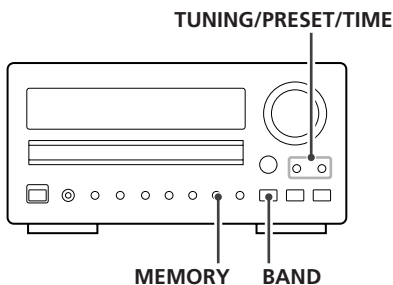

You can store up to 30 FM, 30 AM and 10 DAB stations.

Preset Manually (FM/AM/DAB)

1 Select DAB, AM or FM by pressing the **BAND** button.

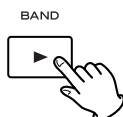

2 Tune the station you would like to store.

3 Press the **PROGRAM/MEMORY** button briefly.



FM or AM

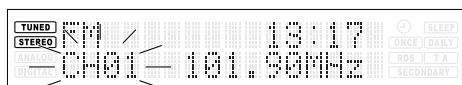

DAB



'CH01' or '01' blinks on the display.

4 Within 4 seconds, select the preset you would like to use for this station using the **TUNING/PRESET/TIME** buttons.



You can also use the numeric buttons of the remote control unit.

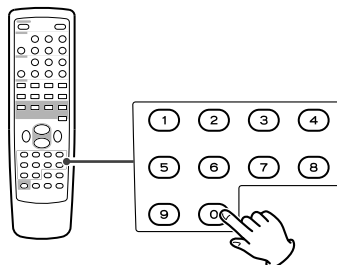

For instance, to select preset number 25, first press the TUNER button, and then press '2' and '5'.

To select numbers less than 10, press '0' and then the number. As an example, to select number 5, press '0' and '5'. (Optionally, you may press just the number '5' and then wait a few seconds.)

5 Within 4 seconds, press the **PROGRAM/MEMORY** button.



- If you don't press the PROGRAM/MEMORY button within 4 seconds after selecting the channel, the selection will be canceled.

To store more stations, repeat steps **1** to **5**.

Preset Automatically (FM/AM only)

1 Select AM or FM by pressing the **BAND** button.

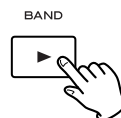

2 Press the **MEMORY** button for more than 3 seconds.



Up to 30 of the best received stations in your area will be stored automatically.

Preset Tuning 2

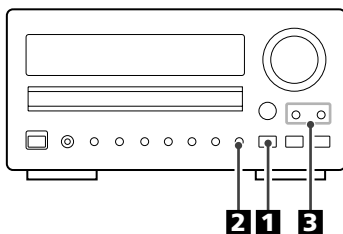

How to select DAB preset stations

See 'Preset tune' of page 24.

How to select FM/AM preset stations

1 Select AM or FM by pressing the **BAND** button.

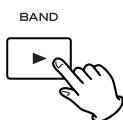

2 Select 'Preset tune' by pressing the **TUNING MODE** button.



3 Select a preset channel.

Press the **TUNING/PRESET/TIME** button repeatedly until the desired preset station is found.



- Preset channels can also be selected by the PRESET CALL buttons or the numeric buttons of the remote control unit.
- When using the remote control unit, you can skip step **2**.

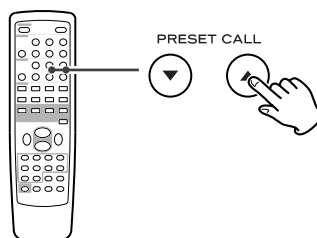
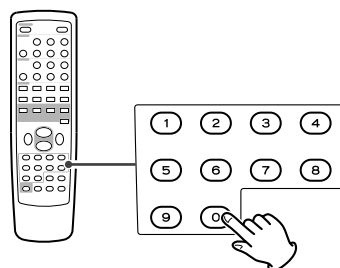

The Radio Data System(RDS) is a broadcasting service which allows stations to send additional information along with the regular radio programme signal.

RDS works on the FM waveband in Europe only.

1 Tune in an FM station (see steps 1 to 3 of page 28).

2 Press the RDS MODE button.

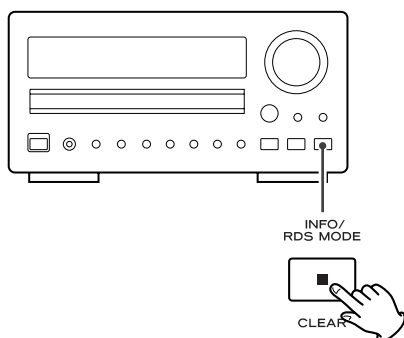

Each time the RDS MODE button is pressed briefly, the RDS mode is changed as follows:

PROGRAM SERVICE

When you select PROGRAM SERVICE, 'PROGRAM SERVICE' will blink for about 3 seconds and then the programme service name or a station's name will be displayed. If there is no programme service data, the frequency will be displayed.

RDS CLOCK TIME

displays the information about times provided from the station.

When you select RDS CLOCK TIME, 'RDS CLOCK TIME' will blink for about 3 seconds and then the clock time will be displayed.

If there is no time data, 'NO CT' will be displayed.

RDS PROGRAM TYPE

When you select RDS PROGRAM TYPE, 'RDS PROGRAM TYPE' will blink for about 3 seconds and then the programme type will be displayed.

RDS RADIO TEXT

When you select RDS RADIO TEXT, 'RDS RADIO TEXT' will blink for about 3 seconds and then the news of stations composed of up to 64 symbols will be displayed.

If there is no radio text data, RDS mode will be automatically switched to PROGRAM SERVICE mode.

TRAFFIC ANNOUNCE

When you select TRAFFIC ANNOUNCE, 'TRAFFIC ANNOUNCE' will blink for 3 seconds and then the unit searches for a traffic announcement.

- When a traffic programme is found, the TRAFFIC ANNOUNCE mode is switched to PROGRAM SERVICE mode.

If the station currently selected is transmitting a traffic program signal, the RDS mode will be switched to PROGRAM SERVICE mode without searching for a traffic program.

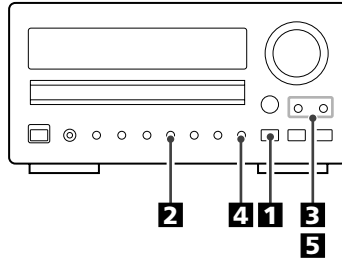

You can search for stations by programme type.

1 Select FM by pressing the BAND button.

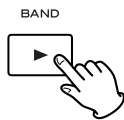

2 Press the INFO/RDS MODE button for more than 3 second.

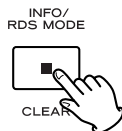

3 Select the desired PTY programme using the TUNING/PRESET/TIME buttons.



Select your desired one from among 31 kinds of PTY programmes. The programme type will blink.

4 Press the ENTER/SET button.

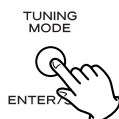

The programme type stops blinking.

5 Press the TUNING/PRESET/TIME button.

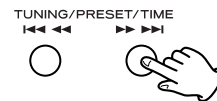

Search starts.

- When the programme that you have selected is found, searching stops and the programme type will be displayed.
- If the same programme type is not found during PTY Search, it will stop at the beginning frequency.
- If you want to stop searching, press the INFO/RDS MODE button.

About DAB

NEWS	: brief announcements, events, public opinion, reports, actual situations.
AFFAIRS	: a kind of suggestion including practical announcements other than news, documents, discussion, analysis and so on.
INFO	: daily information or reference such as weather forecast, consumer guide, medical assistance and so on.
SPORT	: sports related programs.
EDUCATE	: educational and cultural information.
DRAMA	: all kinds of radio concert and serial drama.
CULTURE	: all aspects of national or local culture including religious events, philosophy, social science, language, theatre, and so on.
SCIENCE	: programs on natural science and technology
VARIED	: popular programs such as quiz, entertainment, private interview, comedy, satire and so on.
POP M	: program on commercial, practical and popular songs, and sale volume of discs, etc.
ROCK M	: practical modern music generally composed and played by young musicians.
EASY M	: popular music usually lasting for less than 5 minutes.
LIGHT M	: classical music, instrumental music, chorus, and light music favored by non-professionals.
CLASSICS	: orchestra including great operas, symphony, chamber music and so on.
OTHER M	: other music styles(Rhythm & Blues, Reggae, etc.)
WEATHER	: weather reports, forecast
FINANCE	: financial reports, commerce, trading
CHILDREN	: children's programs
SOCIAL	: social affairs
RELIGION	: religious programs
PHONE IN	: program in which the public expresses its view by phone.
TRAVEL	: travel reports
LEISURE	: programs concerning recreational activities
JAZZ	: jazz music
COUNTRY	: country music
NATION M:	national music
OLDIES	: music from the so-called golden of popular music
FOLK M	: folk music
DOCUMENT:	documentaries
TEST	
ALARM	: a program notifying an emergency or a natural disaster.

With this unit you can receive and listen to Digital Audio Broadcast (DAB) programmes. DAB uses digital, not analogue signals, resulting in near CD-quality audio with virtually interference-free reception. Along with superior quality audio, DAB can also deliver additional audio channels and text. In the future, computer data and images are also possible.

Digital radio is broadcast as groups of data called ensembles or multiplexes. Each multiplex can contain a number of stations (services) and each station contains a primary service and can contain secondary services as illustrated in the following diagram.

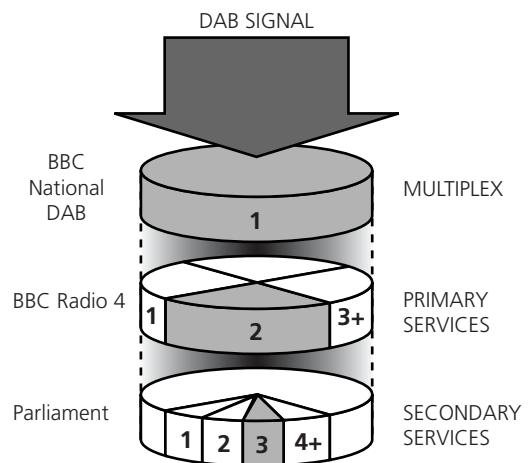

Each multiplex is transmitted in a set frequency range and received by this unit for decoding. You can receive multiplexes broadcast in the 174-240 MHz frequency band and store the services in each multiplex for you to access. The number of multiplexes you receive depend on your location. Channels used in the UK are in the range 10A to 12D.

Multiplexes and stations have labels (names) that are used to identify them. Instead of needing to know the particular frequency of your favourite broadcast, you can simply select the station name. Secondary services and additional data such as text or multiplex info are also available.

Setting the Clock

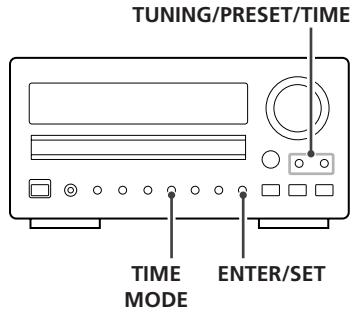

1 Press the TIME MODE button.



Every time the TIME MODE button is pressed, the mode is changed as follows.

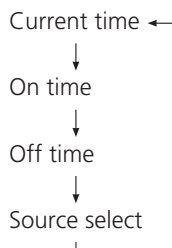

- The unit uses the 24 hour 'military' clock.
- When no action is taken for 1 minute, the time adjust mode will be cancelled.

2 Press the TUNING/PRESET/TIME buttons to set the current hour.



3 Press the ENTER/SET button.

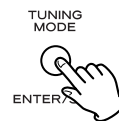

The 'minute' value blinks.

4 Press the TUNING/PRESET/TIME buttons to set the current minute.

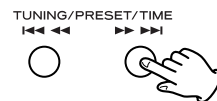

5 Press the ENTER/SET button.



The clock starts from 00 second.

- Press the STOP button to cancel the time setting.

Setting the Timer

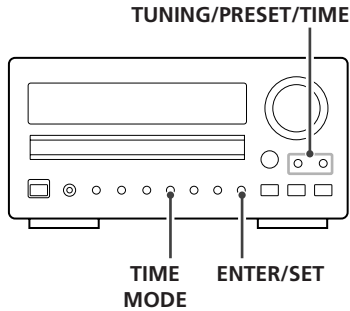

- Adjust the clock before setting the timer.
- When no action is taken for 1 minute, the timer setting mode will be cancelled.

1 Press the **TIME MODE** button repeatedly until 'On time' is displayed.



'On time' appears on the display, and the 'hour' value blinks.

2 Press the **TUNING/PRESET/TIME** buttons to set the hour value, and press the **ENTER/SET** button.

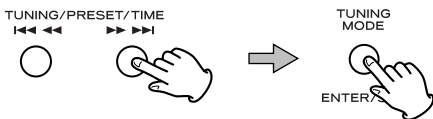

The 'minute' value blinks.

3 Press the **TUNING/PRESET/TIME** buttons to set the minute value, and press the **ENTER/SET** button.

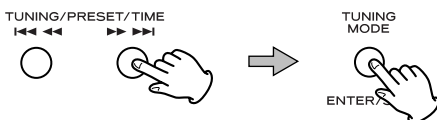

'Off time' appears on the display, and the 'hour' value blinks.

4 Repeat step **2** and **3** to set the Off time.

'Source select' appears on the display.

5 Press the **TUNING/PRESET/TIME** buttons to select the source, and press the **ENTER/SET** button.

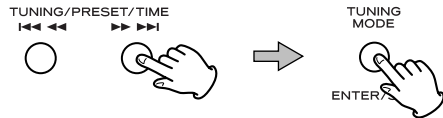

Now the timer setting is stored in memory.

6 Press the **TIMER** button.



The timer indicator '⊕' lights on the display.

7 Prepare for timer operation.

Adjust the volume, tune in a station, set CD, etc.

All the units connected by remote control cords will turn on and off at the specified time every day.

When you don't use timer, press the **TIMER** button to turn it off. (The timer indicator '⊕' disappears from the display.)

Press the **TIMER** button again to turn it on.

8 Press the **STANDBY/ON** button to turn the unit standby.



Sleep Timer

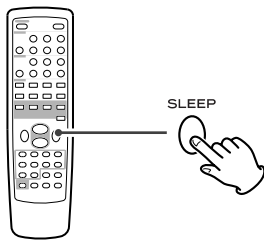

The power can be switched off after a specified amount of time.

Press the SLEEP button repeatedly until desired time appears on the display.

SLEEP-90 (80, 70 ... 10)

The power will be switched off 90 (80, 70 ... 10) minutes later.

(normal display)

The sleep timer is off.

- The display is dimmed when you set the sleep timer.
- If you want to check the remaining time, press the SLEEP button once. The remaining time will be displayed for 3 seconds, and return to the normal display.

How to Reset the Settings to the Factory Defaults

If the power supply is interrupted for 14 days or longer, all the settings kept in memory (such as preset stations and timer settings) will be erased.

It will take more than 3 days after plugging the power cord into the outlet to charge enough electricity for the memory backup function.

If you want to manually initialize the settings, hold down the FUNCTION/FM MODE button for more than 4 seconds in stanby mode.

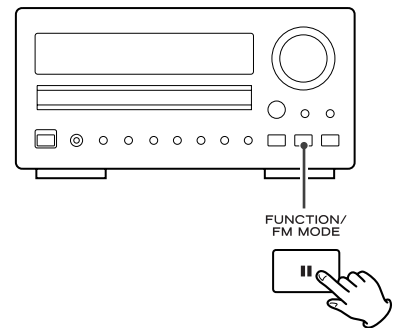

The unit will be turned on, and all the settings are reset to the default settings.

Specifications

AMPLIFIER Section

Output Power25 W/ch (6 ohms, 0.5 %,1 kHz)
Input Sensitivity 300 mV/47k ohms
Frequency Response . 20 Hz to 60,000 Hz (+1/-3dB)

TUNER Section

FM Section

Tuning Range 87.50 MHz to 108.00 MHz
(50 kHz steps)
Signal-to-Noise Ratio 65dB (Mono)
60dB (Stereo)
Presets 30

AM Section

Tuning Range 522 kHz to 1629 kHz
(9kHz steps)
Signal-to-Noise Ratio 35 dB
Presets 30

DAB Section

Tuning range Band 3, 174MHz-240MHz
Input 50 ohms, nominal
Max signal -3dBm typ
Sensitivity -96dBm typ
Adjacent Channel Rejection 35dB typ

Presets 10
Audio output Stereo, 2.5V P-P
Digital output 24 bit/48 kHz resolution

CD PLAYER Section

Frequency Response . . . 20 Hz to 20,000 Hz (± 2 dB)
Signal-to-Noise Ratio more than 85dB
Wow and Flutter Unmeasurable

GENERAL

Power Requirements 230 V AC, 50 Hz
Power Consumption 75 W
(standby) 2 W

Dimension (W x H x D) 215 x 110 x 359 mm
Weight 4.4 kg

Standard Accessories

Remote Control Unit (RC-956) x 1
Batteries (AAA) x 2
AM Loop Antenna x 1
FM Lead-type Antenna x 1
DAB Antenna x 1
Owner's Manual x 1
Warranty Card x 1

- Design and specifications are subject to change without notice.
- Weight and dimensions are approximate.
- Illustrations may differ slightly from production models.

Troubleshooting

In case of trouble with the unit, please take the time to look through this chart and see if you can solve the problem yourself before you call your dealer or TEAC service center.

Amplifier

No power

- Check the connection to the AC power supply.

No sound from speakers.

- Check the connection to the speakers.
- Adjust the volume.
- Select proper source.
- Pull out the headphone plug from PHONES jack.
- If muting is on, press the MUTING button.

The sound is noisy.

- The unit is too close to a TV set or similar appliances. Install the unit apart from them, or turn them off.

Remote Control Unit

Remote control doesn't work.

- If the batteries are exhausted, change the batteries.
- Use remote control unit within the range (5m) and point at the front panel.
- Clear obstacles between the remote control unit and the main unit.
- If a fluorescent light is near the unit, turn it off.

Tuner (FM/AM)

Cannot listen to any station, or signal is too weak.

- Tune in the station properly.
- If a TV is near the unit, turn it off.
- Install the antenna again after locating the best reception position.
- An external antenna is recommended.

Though the broadcast is stereo, it sounds monaural.

- Press the FM MODE button.

DAB tuner

No sound.

- Ensure that the CR-H250 has been able to locate DAB stations.

'NO stations Available' appears on the display.

- Check that antenna is connected (see page 7).
- Ensure that DAB coverage exists in your area.

Cannot access secondary services.

- At the time of publishing not many secondary services are available, this will increase as more DAB stations start broadcasting. If a secondary service station is available, the secondary indicator >> will be displayed next to the station name.

Display goes out or displayed 'service off air'.

- This may occur if a broadcaster changes the label of a service or removes a label whilst you are listening to it. The CR-H250 will try to retune to this station, or alternatively follow the procedure for auto tune on page 26.

Cannot listen to the selected station.

- Ensure you have pressed the ENTER button when you want to listen to your selection. The station you are currently listening to will be displayed on the first line of the display, as you scroll through the station order list the second line will show other station options. Press the ENTER button to activate your selection.

A burbling sound is heard on some stations.

- DAB like other digital media is good at producing quality audio from a low level signal, however if this signal level is too low a 'burbling' sound can sometimes be heard. To reduce this, try repositioning your antenna to gain maximum signal strength.

CD Player

Cannot play.

- ➔ Load a disc with label side up.
- ➔ If the disc is dirty, clean the surface of the disc.
- ➔ A blank disc has been loaded. Load a prerecorded disc.
- ➔ Unfinalized CD-R/CD-RW disc is not playable. Finalize the disc properly.

Sound skips.

- ➔ Place the unit on a stable place to avoid vibration and shock.
- ➔ If the disc is dirty, clean the surface of the disc.
- ➔ Don't use scratched, damaged or warped discs.

No program playback.

- ➔ In the stop mode press PROGRAM button to enter the program mode, and press play button to start playing.

If normal operation cannot be recovered, unplug the power cord from the outlet and plug it again.

Maintenance

If the surface of the unit gets dirty, wipe with a soft cloth or use diluted neutral cleaning liquid. Be sure to remove any fluid completely. Do not use thinner, benzene or alcohol as they may damage the surface of the unit.

Beware of condensation

When the unit (or a disc) is moved from a cold to a warm place, or used after a sudden temperature change, there is a danger of condensation; vapor in the air could condense on the internal mechanism, making correct operation impossible. To prevent this, or if this occurs, leave the unit for one or two hours with the power turned on. The unit will stabilize at the temperature of its surroundings.

TEAC

TEAC CORPORATION	3-7-3, Nakacho, Musashino-shi, Tokyo 180-8550, Japan Phone: (0422) 52-5081
TEAC AMERICA, INC.	7733 Telegraph Road, Montebello, California 90640 Phone: (323) 726-0303
TEAC CANADA LTD.	5939 Wallace Street, Mississauga, Ontario L4Z 1Z8, Canada Phone: (905) 890-8008
TEAC MEXICO, S.A. De C.V	Campesinos N°184, Colonia Granjas Esmeralda, Delegacion Iztapalapa, CP 09810, México DF Phone: (525) 581-5500
TEAC UK LIMITED	5 Marlin House, Croxley Business Park, Watford, Hertfordshire, WD18 8TE, U.K. Phone: 01923-819699
TEAC EUROPE GmbH	Bahnstrasse 12, 65205 Wiesbaden-Erbenheim, Germany Phone: 0611-71580
TEAC FRANCE S.A.	17, Rue Alexis-de-Tocqueville, CE 005 92182 Antony Cedex, France Phone: (1) 42.37.01.02
TEAC ITALIANA S.p.A.	Via C. Cantù 11, 20092 Cinisello Balsamo, Milano, Italy Phone: 02-66010500
TEAC AUSTRALIA PTY., LTD.	280 William Street, Melbourne VIC 3000, Australia Phone: (03) 9672-2400 A.B.N. 80 005 408 462

This appliance has a serial number located on the rear panel. Please record the model number and serial number and retain them for your records.

Model number

Serial number

0704-MA-0906A

Free Manuals Download Website

<http://myh66.com>

<http://usermanuals.us>

<http://www.somanuals.com>

<http://www.4manuals.cc>

<http://www.manual-lib.com>

<http://www.404manual.com>

<http://www.luxmanual.com>

<http://aubethermostatmanual.com>

Golf course search by state

<http://golfingnear.com>

Email search by domain

<http://emailbydomain.com>

Auto manuals search

<http://auto.somanuals.com>

TV manuals search

<http://tv.somanuals.com>