

TechniSat®

GigaSwitch 11/20G

GigaSwitch 11/20K

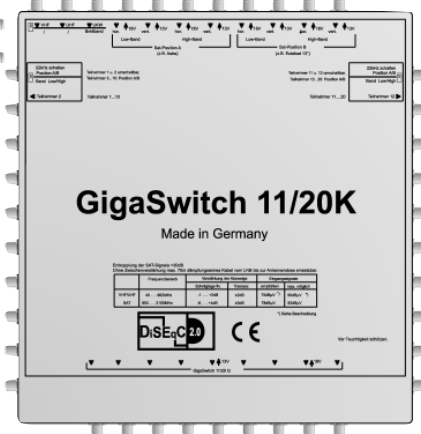

Installation Manual and User Instructions

Contents

1	Function	2
2	Safety Advice	3
3	Introducing the components	3
3.1	GigaSwitch 11/20G	3
3.2	GigaSwitch 11/20K	3
3.3	Intermediate Amplifier 9Z	4
3.4	Distributor 9V	4
4	Settings	4
4.1	Switchable outputs for each party, 22 kHz or DiSEqC	4
4.2	Settings for terrestrial inputs	5
5	Installation	5
5.1	General	5
5.2	Selecting an external unit	6
5.3	LNBs	6
5.4	Cable	6
5.5	Selecting Antenna Connectors	7
6	Installation Hints	7
7	Installation examples	8
8	Troubleshooting Guide	11
9	Technical Data	12

1 Function

The GigaSwitch 11/20 multiswitch is used to supply between 20 and 120 receiving participants with a satellite intermediate frequency as well as with a terrestrial signal.

The following combinations can be distributed by this piece of equipment::

> two full bands of the Astra satellite Low and High Band plus the EUTELSAT Low and High Band;

or

> four satellites of your choice with two polarisation planes each;

or

> eight individually selected polarisation planes.

> In addition, FM, VHF and UHF inputs are available for distribution of terrestrial signals.

The GigaSwitches comply fully with the Astra IES concept (integrated reception system).

The star-form distribution provided by the GigaSwitch 11/20 multiswitch provides the advantage of permitting reception of other satellite services to receiving parties without any additional installation.

2 Safety Hints

For your own protection, you should read the safety hints carefully before installing the GigaSwitch multiswitch. The manufacturer accepts no responsibility for damage caused by non-observance of the safety hints, or by inappropriate handling.

- > The components must be mounted in dry rooms on flat, non-flammable surfaces.
- > Air circulation slots on the components must permit unimpeded circulation.
- > The installation must be carried out while the unit is not connected to the power mains.
- > The multiswitch must be connected to ground (earthed).
- > The antenna installation must comply with local regulations relating to lightning protection.
- > The relevant EU standards as well as VDE or national regulations relating to electrical safety must be observed.
- > National regulations relating to broadcast reception equipment must be observed.
- > Never open the unit cover, as you may be subject to an electrical shock!!!
- > If it becomes necessary to open the unit, this should only be carried out by trained personnel.

In the following cases, you should disconnect the unit from the power mains, and call an expert/trained personnel:

- > When the unit has been subject to extreme humidity, or when liquid has entered the unit;
- > When the unit malfunctions;
- > If the unit shows severe external damage.

3 Introducing the components

3.1 GigaSwitch 11/20G (Part No. 0000/3229)

The GigaSwitch 11/20G is the basic unit in the multiswitch range. The GigaSwitch 11/20G provides distribution of the Intermediate Frequency signal to 20 participants, including provision of power to the LNBS. In larger installations it also provides the power for the cascade multiswitch GigaSwitch 11/20K, for the distributor 9V and for the intermediate amplifier 9Z. When installing a cascade system of several components, please ensure that the maximum power voltage is not exceeded (see technical specifications).

3.2 GigaSwitch 11/20K (Part No. 0000/3228)

The GigaSwitch 11/20K is the cascade unit in the multiswitch range. This unit receives its power supply from the basic unit GigaSwitch 11/20G. The GigaSwitch 11/20K unit can thus only be used in conjunction with the basic unit. The GigaSwitch 11/20K is inserted between the LNBS and the basic unit, with each additional 11/20K unit providing connections for 20 participants.

The function of the cascade is to distribute the eight polarisation planes as well as the terrestrial signal further along the main connection, and to provide up to 20 participants with independent access to the selected band.

3.3 Intermediate Amplifier 9Z (Part No. 000/3231)

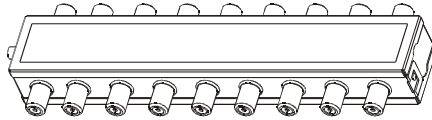

The intermediate amplifier 9z has been designed to compensate for the damping effect of 25m of multimedia cable, or of 40m of CoaxSat 2150 cable, when used to transmit satellite signals. The amplification of terrestrial signals can be adjusted.

3.4 Distributor 9V

This is used to achieve a three-way split of main-line connections, while providing a high degree of insulation.

A cascade switch can be connected directly to the lower outputs. The outputs at the front can be used to feed a further 2 cascade units, using up to 20m of multimedia cable.

One or more distributors can thus be used to assemble fairly large installations.

- > Where the damping of the main line connection is less than 5 dB (at 2150 MHz), no intermediate amplifier is required. The intermediate amplifier 9Z is only required where higher damping levels are present.

4 Settings

4.1 Switchable outputs for each party, 22 kHz or DiSEqC control

On the side panels of the unit, above each of the uppermost participant output connections you will find a switch with which you may set the reaction of the specific output connector with regard to 22 kHz or DiSEqC control. These switches relate exclusively to parties 1 and 2, as well as to parties 11 and 12. They are provided for receivers that do not provide a DiSEqC control facility. For such receivers you must select individually the inputs you wish to address with the 22 kHz control.

a) Position A/B

If the switch is in this position, the Low Band of Position A will be received without the 22 kHz control signal, and the Low Band of Position B will be received with the aid of the 22 kHz control signal.

b) Band Low/High

If the switch is in this position, the Low Band of Position A will be received without the 22 kHz control signal, and the High Band of Position B will be received with the aid of the 22 kHz control signal.

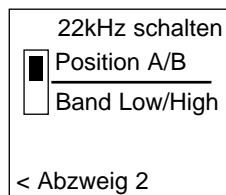

The switches are preset to **Position A/B** at the factory so that receivers which do not have

DiSEqC control functions can utilise the 22KHz control signal to switch to the Low Band setting of Eutelsat 13°. All other outputs are fixed in terms of their switching position.

The setting of this switch is irrelevant for and not applicable to DiSEqC-compatible receivers.

4.2 Setting of terrestrial inputs

Terrestrial signals can be fed into the system in separate bands, or as a broad band signal. Use the switch provided to set the required function:

a) Switch in up position

Separate inputs for VHF, UHF and FM are activated.

b) Switch in down position

The VHF and UHF inputs are deactivated, and should be terminated with 75 Ohm resistors. The broad band signal is fed into the system via the FM (UKW) connector.

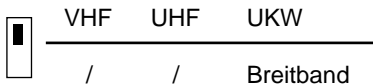

The distribution system is designed to cope with the damping effect of cable up to about 20 dB (between LNBS and antenna connector) at 2150 MHz. An active diagonal plane compensation is implemented in order to compensate for cable damping in the satellite range. The high level of decoupling of the satellite signals means that damping compensators in the main line connections are not required. The required level of damping can be achieved by varying the cable type, dependent on the cable length.

The input level should be at 75 dB μ V

It is possible to configure the terrestrial frequency range with 42 channels in accordance with CENELEC regulations. Likewise, due to the carefully designed low-damping system for terrestrial reception with diagonal compensation there will be no problem in future to accommodate DVB-T or DVB-C (terrestrial or cable-fed digital television).

5 Installation

5.1 General

- > We recommend that the star-form distribution should originate in the attic, or near the centre of the house/building.
- > Should the distribution originate in the cellar/basement, we recommend you fit an interim amplifier Type 9Z between the basic unit multiswitch and the LNBS.
- > Please ensure that the levels of the various satellite systems are approximately equal.
- > We recommend, particularly with relatively large installations, that you check all cables for short circuiting before fitting contacts/connectors, as it will take much longer to search for faults at a later stage.
- > Ensure that main connections are not mixed up in any way. You may find it easier to make the connections in the distribution system using multi-coloured cable.

5.2 Selecting an external unit

- > Ensure that your satellite dish is of adequate size for local conditions. We recommend a minimum diameter of 85 cm, and of 1m in the eastern regions of Germany. This means that satellite reception will generate a picture with a signal-to-noise ratio of 48 dB.

5.3 LNBs

- > You may choose quattro, dual output or twin LNBs, but not universal twin types.
- > Use only high-quality LNBs from reputable manufacturers, such as TechniSat Part. No. 0000/8880, providing either linear or diagonal frequency compensation. The output level should be >75 dB μ V.
- > The LNBs receive their mains power supply via the basic unit GigaSwitch 11/20G. Please note the maximum power supply as per the technical specifications.

5.4 Cables

- > We recommend that you use crimp-type connectors only!
- > We recommend CoaxSat 2150 cable for your connections leading to the LNBs. If the circumstances within the house/building permit, this type of cable should also be used for the connections to the individual participants.
- > For systems distributing to more than 40 participants we recommend the use of multimedia cable for the main line connections (1 x 4-strand, 1 x 5-strand).
- > Cables must be insulated as follows:

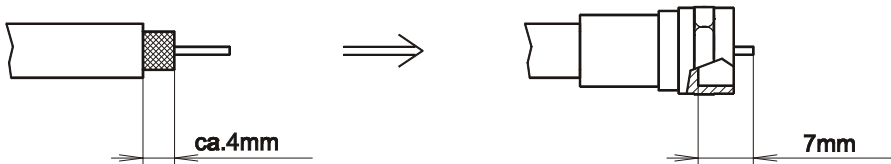

Damping (dB/x/metre) of suitable cable types

Type At MHz	CoaxSat 2150				Mini Coax				Multimedia 4 u. 5			
	40	300	860	2150	40	300	860	2150	40	300	860	2150
10m	0.3	1	1.8	3	0.5	1.5	2.5	4.2	0.7	1.7	3	4.9
20m	0.6	2	3.6	6	1	3	5	8.4	1.4	3.4	5	8.4
30m	0.9	3	5.4	9	1.5	4.5	7.4	12.6	2.1	5.1	9	14.7
40m	1.2	4	7.2	12	2	6	10	16.8				
50m	1.5	5	9	15	2.5	7.5	12.5	21				
60m	1.8	6	10.8	18								
70m	2.1	7	12.6	21								

5.5 Selecting the antenna connectors

The individual participants are connected by means of antenna connectors, e.g. types SV 500, SVT 500. This allows terrestrial programmes to be received without any need to change the connectors. At the same time, this type of connector also protects the receiver from faults occurring outside the bandwidth.

Output levels of a SV 500 antenna connector:

	Damping of connector (dB)	Level (dB μ V)		
		minimal	recommended	maximal
Sat-bands		47	58	79
UKW	2	50	63	70
VHF	5	55	63	70
UHF	4	55	63	70

6 Installation Hints

- > We recommend a star-form distribution originating in the attic, or near the centre of the house/building.
- > Please ensure that the levels of the various satellite signals fed into the system are approximately equal in strength.
- > The outputs for participants 5...10 and 16...20 supply a higher output level in the satellite band. You should use these outputs to connect participants with longer cable connections.
- > Checking all cable connections before connectors are fitted (to identify short circuits) saves a lot of time possibly searching for faults once everything has been installed.
- > Ensure that connections coming from the LNB are not mixed up.
- > If you are installing a fairly large set-up, draw up an input level diagram before you start.
- > Make your calculations based on the amplification values given in the technical specifications as well as the appropriate cable damping factors as set out above.
- > Try to use single uninterrupted lengths of coaxial cable to make your connections. F-connector plugs may cause interference of DVB signals.
- > Ensure the covers of the F-connectors are secured moderately tight. You should use the adjustable spanner Art. No. 0000/3407.
- > Do not use snap-tight F-connector covers!
- > Some older models of LNB require an operating current of 12 V. In this case, be sure to switch on the voltage limiter provided by the LNB manufacturer between the LNB and the input of the multiswitch.

Distribution of terrestrial programmes:

- > Ensure that output levels are approximately equal (recommended 75 dB μ V/Maximal 90dB μ V)
- > When receiving several terrestrial channels from the same direction, you can utilise one or more interference filters, eg. TSF 2169/2, Part. No. 000/6042 in order to adjust signal levels. You will have to know the band allocation, and use an antenna (signal strength) measuring instrument in order to set the levels of the interference filters in such a way that weaker signals are not lost against the background noise.
- > If additional diagonal compensation is required, TechniSat manufactures a BK compensator, Part No. 0000/3166.
- > It may be beneficial to insert a damping unit each at the FM input if FM or cable signals are being fed into the system.
- > Signal strengths of < 55 dB μ V are not suitable for distribution systems.
- > Where input signals are weak, a low-noise pre-amplifier with high damping should be employed.
- > If a 11/20K unit is cascaded directly with a 11/20G basic unit it may be necessary, depending on input levels, to insert a damping controller in the terrestrial signal path between the two units.
- > If it is your intention to supply a number of participants with only terrestrial signals, you should distribute only the combined terrestrial input signal. If necessary, a pre-amplifier can be included in the circuit before the signal reaches the multiswitch.

7 Installation examples

Installation for up to 20 participants

Distribution from attic;

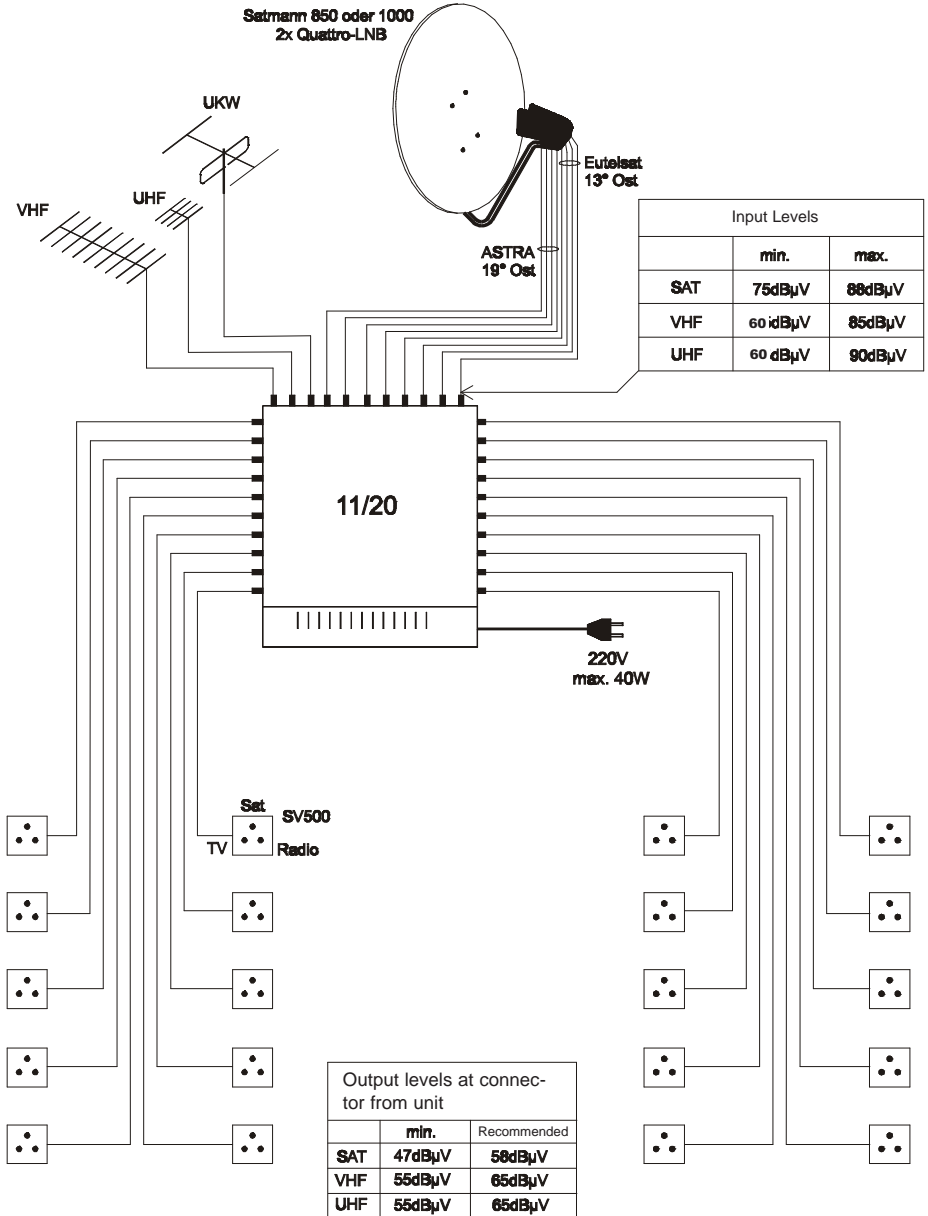

Installation for 80 participants

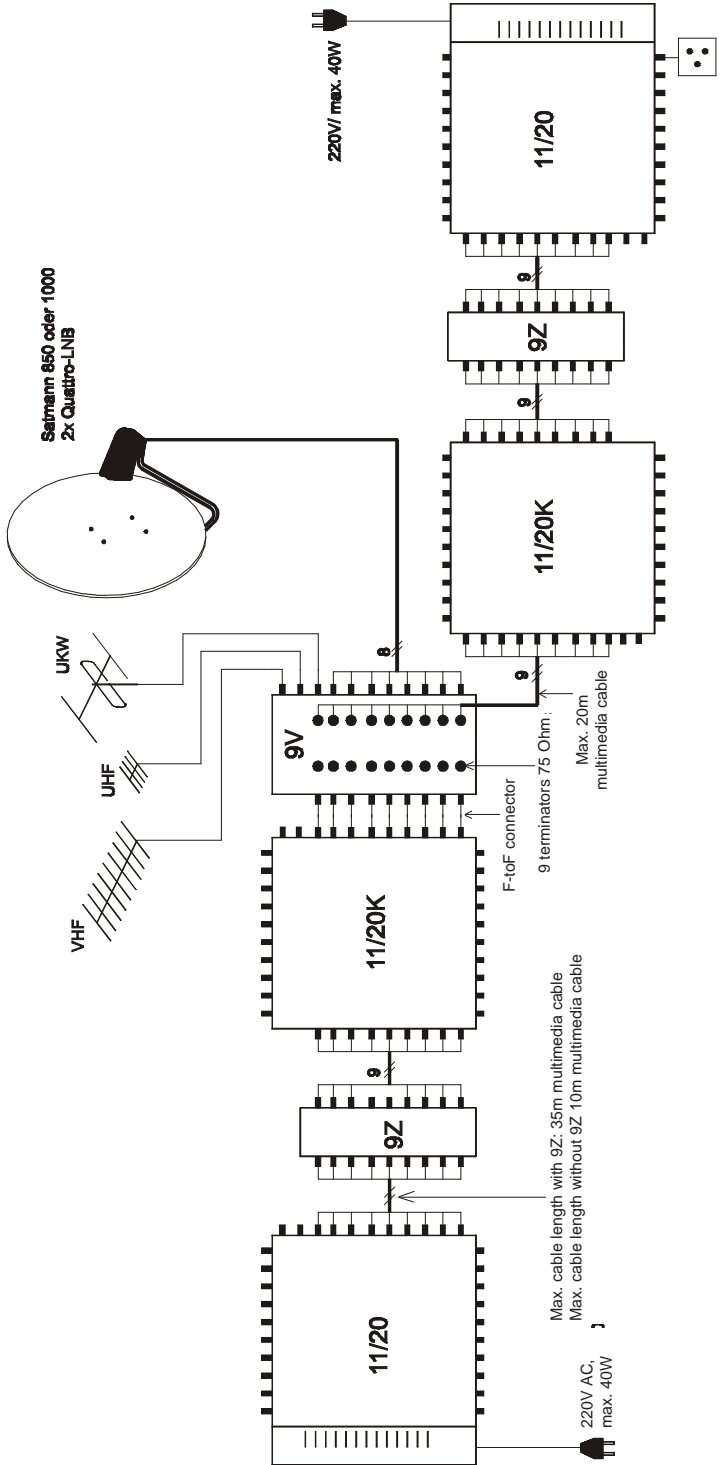

Installation for 120 participants

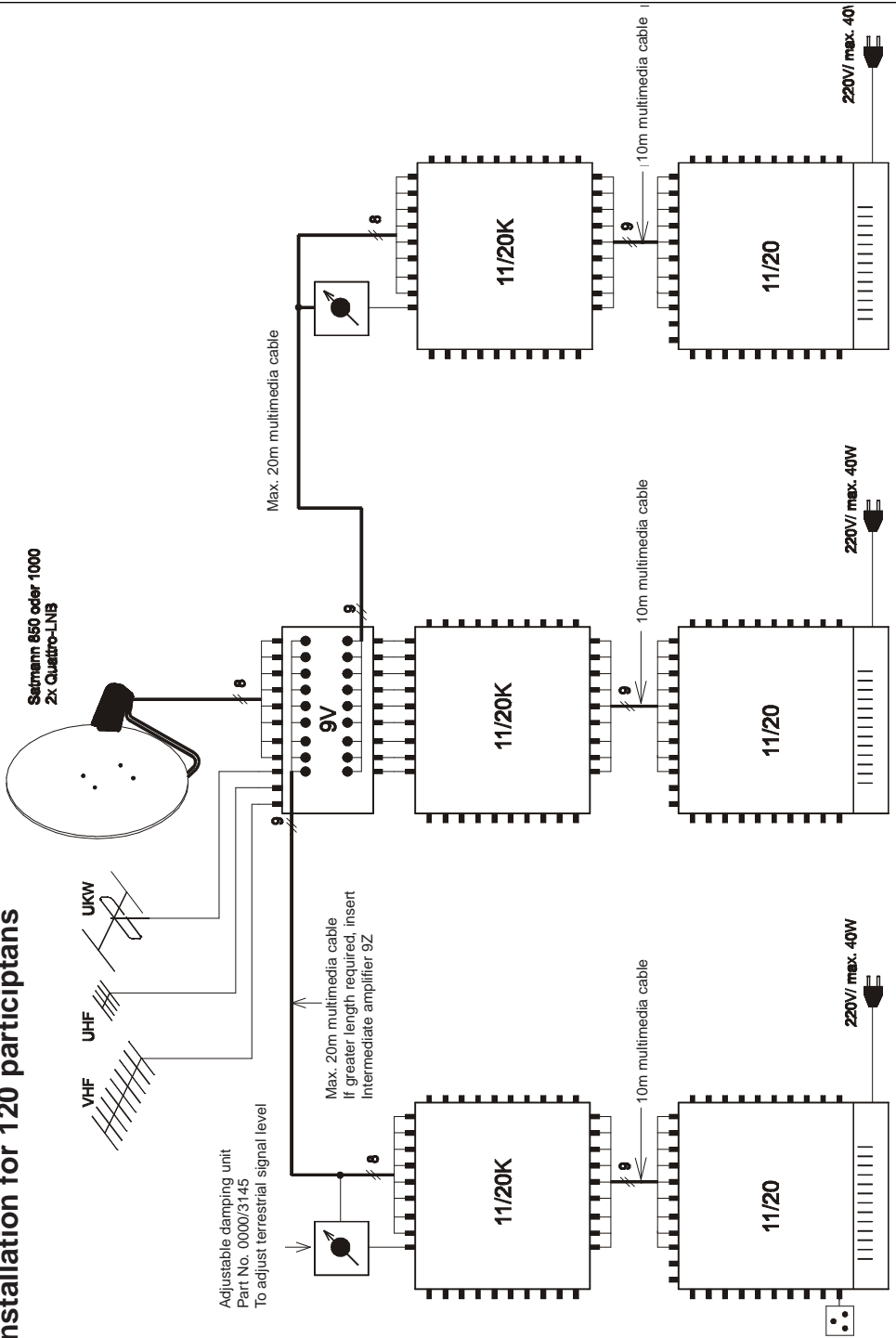

8 Troubleshooting guide

Problem	Possible cause	Solution
No reception on any polarisation plane > green LED blinking	Short circuit in LNB	Remove each cable individually, until green LED remains on. Fix short circuit cable section
No reception on any polarisation plane > green LED on	Antenna adjustment faulty	Check signal incoming to LNB. Check that correct LOF setting is set at receiver. Check power supply of LNB at 11/20.
No reception or wrong programme at specific polarisation planes	LNB connections mixed up, or core cable too short	Check allocation of cables and connectors. Check the LNB connection directly. Note however that power is not supplied to all outputs of quatro LNBs
Individual participant outputs not working	LNB voltage and/or switching criteria of the receiver incorrect	See what happens if the receiver is connected to a different participant's output. Be sure to switch on the receiver after connecting it, in order to reset switching criteria. Check LNB voltage and switching criteria with a testing unit.
Wavy lines in terrestrial TV picture	Input level too high	See technical specifications

Your equipment bears the CE-logo and complies with all relevant EU regulations!

Subject to change and printing errors. Last revised 10/00.

TechniSat is a registered trademark of

TechniSat Digital GmbH

P.O. Box 560

D-54541 Daun Germany

www.technisat.de

	GigaSwitch 11/20, 11/20K	Amplifier 9Z
Frequency range: Satellite Terrestrial	950...2150 MHz VHF 48...68, 118...300 MHz/ UKW 87.5...108 MHz/ UHF 470...862 MHz or (switchable) Broad band 48...862 MHz	950...2150 MHz Broad band 48...862 MHz
Decoupling: Main connections (1) Participant outputs Terrestrial/Sat Sat/Terrestrial	>40 dB >35 dB 30dB at 862 MHz 25dB at 1000 MHz	> 50 dB
Amplification: Main connections Sat Terrestrial Participant Sat Terrestrial	11/20K: 2dB (+/-1dB) 11/20K: 1...3dB (+/-1dB) -6 dB...+2 dB (+/- 3 dB) -4 dB...0 dB (+/- 2 dB)	7...13 dB 10...15 dB (<20 dB adj.)
Max. Input levels: Sat-range (at 2150MHz) (3) Terrestrial (antenna) Terrestrial Broad band (2)	88 dBµV 90 dBµV 75 dBµV	85 dBµV 90 dBµV 75 dBµV
Signal to noise (Terr.)	<4 dB	<4 dB
Damping level	>70 dB	>70 dB
Control	11.5 V...14 V/16 V...20 V; 0/22 KHz +/- 4 kHz with >0.4Vpp and Simple DISEqC-toneburst or DISEqC 1.0 to 2.1 (feedback by switching cell)	-
Power supply: To switch cells To INCs and amplifier	Mains supply 230 V; +/-10%, 50...60 Hz, 25 VA, overload protection and indicator from receiver: <50 mA	v. 11/8G: 70mA/13V, 220mA/18V
Max. LNC power flow at 14V; at 18V:	2x300mA and/or 2 x 300 mA	from 11/8 G)
Operating conditions	Ambient temperature: 25...55°C, use inside buildings only, overload protection of inputs and	outputs: >I= 5kV
Dimensions W x H D	11/20: 310 x 220 x 50mm 11/20K: 310x305x50mm	240 x 85 x 60 mm

- 1) all other main connections and derivatives with signal
- 2) according to 1R8-15; 24 x FM; 36 x terr. TV; ctb 72 dB
- 3) according to DIN EN 50083-3, IMA 35 dB

VSWR: on main connections < 2.5, derivatives < 3

Free Manuals Download Website

<http://myh66.com>

<http://usermanuals.us>

<http://www.somanuals.com>

<http://www.4manuals.cc>

<http://www.manual-lib.com>

<http://www.404manual.com>

<http://www.luxmanual.com>

<http://aubethermostatmanual.com>

Golf course search by state

<http://golfingnear.com>

Email search by domain

<http://emailbydomain.com>

Auto manuals search

<http://auto.somanuals.com>

TV manuals search

<http://tv.somanuals.com>