

EN

No film output on this page

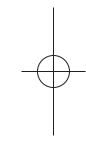
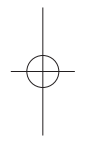

Safety Information

EN Thomson Information

CAUTION!

Invisible laser radiation when open. Avoid exposure to beam. Class 1 laser product. This system must be opened only by qualified technicians to prevent accidents caused by the laser beam.

LASER $\lambda = 780 \text{ nm}$, P max = 5 mW

Rating Information: At bottom/rear of the unit this unit comply with the existing requirements



In accordance with the rating plate of the unit, this unit complies with current standards concerning electrical safety and electromagnetic compatibility.



Please respect the environment Before throwing any batteries away, consult your distributor who may be able to take them back for specific recycling.



Have a Blast- Just Not in Your Eardrums Make sure you turn down the volume on the unit before you put on headphones. Increase the volume to the desired level only after headphone is in place.

ADVARSEL!
USYNLIG LASERSTRÅLING VED ÅBNING NAR
SIKKERHEDSAFBRYDERE ER UDE AF FUNKTION.
UNGDA UDSAETTELSE FOR STRÅLING.
VORSICHT!
UNSICHTBARE LASERSTRALUNG
WENN ABDECKUNG GEÖFFNET UND SICHERHEITS-
VERRIEGELUNG ÜBERBRÜCKT.
NICHT DEM LASERSTRAHL AUSSETZEN!

CAUTION - INVISIBLE LASER RADIATION
WHEN OPEN AND INTERLOCKS FAILED OR
DEFEATED. AVOID EXPOSURE TO BEAM.
ATTENTION - RAYONNEMENT LASER INVISIBLE
DANGEREUX EN CAS D'OUVERTURE ET LORSQUE
LA SECURITE EST NEUTRALISEE.
EXPOSITION DANGEREUSE AU FAISCEAU.



CLASS 1 LASER PRODUCT
LASER KLASSE 1
APPAREIL A LASER DE CLASSE 1
LUOKAN 1 LASERLAITE
KLASS 1 LASERAPPARAT

VARNING-
OSYNLIG LASERSTRÅLING NÄR DENNA DEL
ÄR ÖPPNAD OCH SPÄRRAN ÄR URKOPPLADE.
BETRAKTA EJ STRÅLEN.
VARO!
AVIETTAESSA JA SOJUALUKITUSOHITETTAESSA
OLET ALTIITINA NÄKYMÄTTÖMÄLLE.
LASERSÄTEILYLLE ÄLÄ KATSO SÄTEESEEN.

| | | |
|--|---|--|
| | CAUTION RISK OF ELECTRIC SHOCK DO NOT OPEN | |
| THE LIGHTNING FLASH AND ARROW-HEAD WITHIN THE TRIANGLE IS A WARNING SIGN ALERTING YOU OF "DANGEROUS VOLTAGE" INSIDE THE PRODUCT. | CAUTION: TO REDUCE THE RISK OF ELECTRIC SHOCK, DO NOT REMOVE COVER (OR BACK). NO USER-SERVICEABLE PARTS INSIDE. REFER SERVICING TO QUALIFIED SERVICE PERSONNEL. | THE EXCLAMATION POINT WITHIN THE TRIANGLE IS A WARNING SIGN ALERTING YOU OF IMPORTANT INSTRUCTIONS ACCOMPANYING THE PRODUCT. |
| SEE MARKING ON BOTTOM / BACK OF PRODUCT | | |

WARNING: TO PREVENT FIRE OR ELECTRICAL SHOCK HAZARD, DO NOT EXPOSE THIS PRODUCT TO RAIN OR MOISTURE.

Contents

Safety Information

Before you Begin 1
Useful Advice 1
Battery Power 1
What's so special about this audio CD/mp3 disc player? . . . 1
Music Management Software . 2
MusicMatch™ Jukebox 2
Notes on CD-R/RW Disc 2

General Controls 3
Main Unit 3
Remote Control 4
Display 5

Clock and Timer Setting 6
Setting Clock 6
Setting Timer 6
Enable/Disable Timer 7

Display Setting 8
LCD Contrast 8

Sound Features 8
Volume Control 8
Digital Bass Boost System 8
Boosting the power 8
Equalizer Control 9
Custom Equalizer Setting 9

Tuner 10
Enter Tuner Mode 10
Tuning to a Station 10
Seek Mode 10
Manual Preset Setting 10
Preset Memory Recall 10
To Overwrite Memory
Locations 10
Delete Preset Station 11
Auto Preset Stations (FM only)
. 11
FM stereo 12

mp3 and CD Player . . . 12
mp3 Recommendations 12
Entering CD Mode 12
Inserting Disc 12
Playing CD Discs 13
Skip and Search Tracks 13
Stop Playback 13
Playback Mode 13
Repeat 14
Sampling Tracks 14
Random Playback 14
Program Playlist 15
Add Songs to Playlist 15
Edit Playlist 15
Activate Program Playback 16
. 16
View Program Playlist 16
Delete Song from Playlist 16
Erase Entire Playlist 16

mp3 Main Navigation Keys . . . 17
mp3 CD 17
Smart Trax CD 17
Display Options 18
Playing mp3 CD Discs 18
Skip and Search Tracks 18
Stop Playback 18
mp3 Playback Mode 19
SmartTrax mode 19
Repeat for mp3 Discs 19
Sampling mp3 Tracks 19
Random mp3 Playback 19
mp3 Program Playlist 19
Add Songs to Playlist 19
Navigation Chart 20
Additional Smart Trax
Features 22

Troubleshooting Tips . . 23

MusicMatch Jukebox Troubleshooting Tips . . 24

Maintenance 25

More Information 26

EN

Before You Begin

EN Useful Advice

Do not use your system immediately after transporting it from a cold place to a warm place, as condensation may cause the system to malfunction. If moisture forms inside this system, it may not operate properly. To correct the problem, turn off the power and wait about 30 minutes for moisture to evaporate.

This system is fitted with a laser. To avoid accidents, it is to be opened by qualified technicians only. Never leave the tray open as dust could cover the laser lens and/or the tray could be bumped into accidentally.

Do not place the system near wet areas such as bathrooms and pool side. Avoid storing the system at humid places or near abnormally heated areas. Power is continuously supplied to the system. To disconnect power completely, unplug the power cord from the power outlet.

Battery Power

You can insert 6 D-sized alkaline batteries (not supplied) and you can take your stereo just about anywhere.

- Open the battery compartment door on the bottom of the unit by pressing down on the tab and pulling out the cover.
- Before inserting the batteries, observe the polarities (that is, + and -) of the battery, then relate the polarities to the engraved diagram inside the battery compartment. Insert batteries in the battery compartment.

Note that the AC line cord must be unplugged from the jack on the back of the unit to operate on batteries. 3 AA-sized batteries (not supplied) are needed to keep radio station memory.

IMPORTANT: Be sure to remove batteries when storing the set for more than 30 days. Leaky batteries can badly damage the system. Be sure to dispose of leaky, weak or dead batteries properly according to federal, state, and local regulations.

What's so special about this audio CD / mp3 disc player?

Besides traditional audio CDs, this player is meant to play mp3 files encoded on a CD-ROM. You can store up to 12 hours of music on a single disc (at 128kbps).

Creating mp3 CDs requires the use of a computer with a CD-R / CD-RW writer and a music management software (MusicMatch Jukebox recommended).

To fully enjoy the functionalities of your mp3 CD player, we recommend you to record your mp3 CD using folders and subfolders.

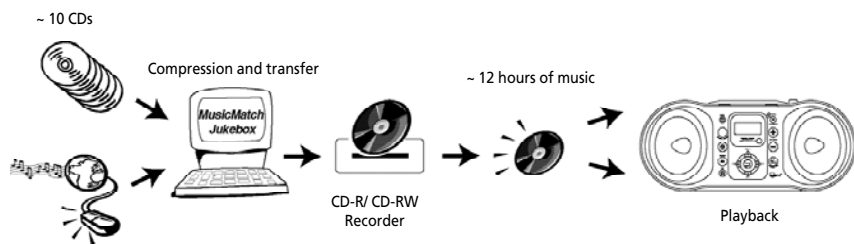

Compressed music
www.musicmatch.com, www.emusic.com

Before You Begin

Music management software - MusicMatch™ Jukebox

Upon unpacking the unit, you should find the music management software - MusicMatch Jukebox enclosed. Insert the software disc into your computer and click on "MusicMatch User's Guide" if you need assistance on installation of the software and creating mp3 discs for your enjoyment with this unit.

You need the latest MMJB Software to enjoy all the features.

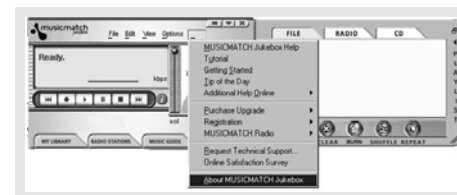

To check which version of MusicMatch Jukebox you are currently using:

1. Click on **Help** to access help menu.
2. Select **About MUSICMATCH Jukebox**.

The software version number can be seen on the top left corner of the information window.

Update MusicMatch Jukebox

Once you have installed the MusicMatch Jukebox software included with your unit, follow the steps below to update your software version.

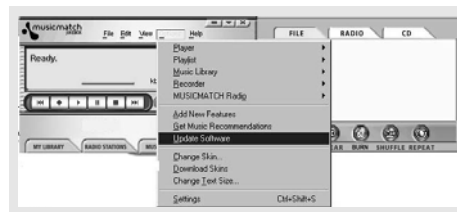

1. Select *Update Software* from the *Options* menu.
2. Select *Update Software to Latest Release*.
3. Click *Continue*.

It will automatically download and install the latest MusicMatch Jukebox software.

Close the window that asks you to *Get your Plus Upgrade Key Now*.

Creating a CD

After placing tracks in the playlist, click **Burn** on the top menu bar.

Note: You are limited to only burning a certain number of CDs. Upgrade to MusicMatch Plus to get unlimited burning.



This unit is compatible with CD-RW/ CD-R discs for playback.

Notes on CD-R/RW Disc:

- Do not affix any type of labels to either side (recordable or labeled side) of a CD-R/RW disc as this may result in the unit malfunctioning.
- To avoid damages to the CD-R/RW disc, do not open the disc compartment door while the disc is being read.
- Do not load an unrecorded CD-R/RW disc into the unit. This may take a longer time to read the disc.
- **Playback capability for CD-RW discs may vary due to variations in the quality of the CD-RW disc and the recorder used to create the disc.**

EN

General Controls

EN Main Unit

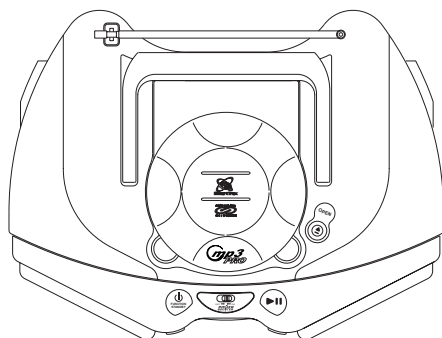
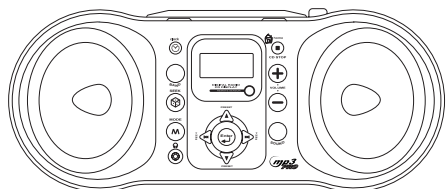

- 1. FUNCTION/STANDBY** - Selects functions: CD mode / Radio mode / Standby mode.
- 2. OPEN** - Opens CD compartment door.
- 3. PLAY/PAUSE** - Plays and pauses CD and mp3 playback.
- 4. CLOCK** - Enters clock and timer setting mode; displays clock time.
- 5. BAND** - Selects between FM, MW and LW radio bands.
- 6. Random Playback/SEEK** - In CD mode, selects Random playback; In radio mode - enables seek function.
- 7. MODE** - Selects options in various operating modes:
Standby modes: System Setting. (LCD Contrast)
Radio modes: Delete Presets
Stereo (FM only) On/Off
System Setting. (LCD Contrast)
mp3 modes: Playmode... (Repeat / Intro / Mix)
Playlist... (Add Song)
System Setting. (LCD Contrast / Browse mode)
CD modes: Playmode... (Repeat / Intro / Mix)
Playlist... (Add Songs)
System Setting. (LCD Contrast)
SmartTrax mode: Playmode...(Repeat/Intro/Mix)
System Setting...(LCD Contrast / Browse mode)
- 8. PHONES** - Connects headphones.
- 9. STOP / home** - Stops CD and mp3 playback; returns to home directory in mp3 and Smart Trax navigation.
- 10. VOLUME +/-** - Increases or decreases volume.
- 11. SOUND** - Turns on/off digital bass boost system; selects among different E.Q. options (Flat, Rock, Jazz, Pop, Classic or Custom)
- 12. PRESET** / - Increase or decrease preset location in radio mode; works as an up and down navigation key in all menus.
- 13. TUNE** (SKIP / SEARCH BACKWARD) - Goes back to previous CD or mp3 track or searches backward; tunes down in radio frequency; returns to the previous menu in navigation mode.
- 14. TUNE** (SKIP / SEARCH FORWARD) - Goes to next CD or mp3 track or searches forward; tunes up in radio frequency; enters the next menu in navigation mode.
- 15. ENTER** - In radio mode - Enters preset mode; In navigation mode, enters selected menu. Also used to select among options in mode menu.
- 16. POWER BOOST** - Toggles the power boost function on or off.

General Controls

EN

Remote Control

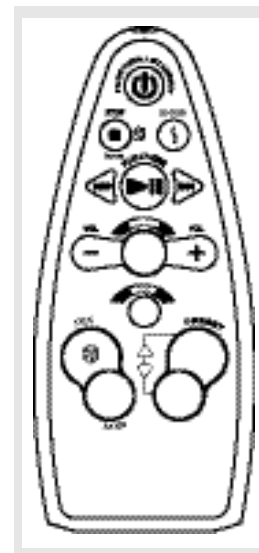

- FUNCTION/STANDBY** - Selects functions: CD mode / Radio mode / Standby mode.
- STOP / home** - Stops CD or mp3 playback; returns to home directory in mp3 and Smart Trax navigation.
- ENTER** - In radio mode - Enters preset mode; In navigation mode, enters selected menu. Also used to select among options in mode menu.
- TUNE** / - Tunes down or up in radio frequency; skips/searches back or skips/searches forward for CD and mp3; enters to the next menu or return to the previous menu during navigation.
- PLAY / PAUSE** - Starts and pauses CD or mp3 playback.
- VOL +/-** - Increases or decreases volume.
- SOUND** - Turns on/off digital bass boost system; selects among different E.Q. options (Flat, Rock, Jazz, Pop, Classic or Custom)
- MODE** - Selects options in various modes:
Standby modes: System Setting. (LCD Contrast)
Radio modes: Delete Presets
Stereo (FM only) On/Off
System Setting. (LCD Contrast)
mp3 modes: Playmode... (Repeat / Intro / Mix)
Playlist...(Add Song)
System Setting. (LCD Contrast / Browse mode)
CD modes: Playmode... (Repeat / Intro / Mix)
Playlist... (Add Songs)
System Setting. (LCD Contrast)
SmartTrax mode: Playmode...(Repeat/Intro/Mix)
System Setting...(LCD Contrast / Browse mode)
- PRESET** / - Selects preset radio stations; works as navigation keys to move up or down menus.
- Random / SEEK - Selects random playback in CD and mp3 mode. In radio mode - enables seek function.
- BAND** - Selects between FM, MW and LW frequency.

Display

EN

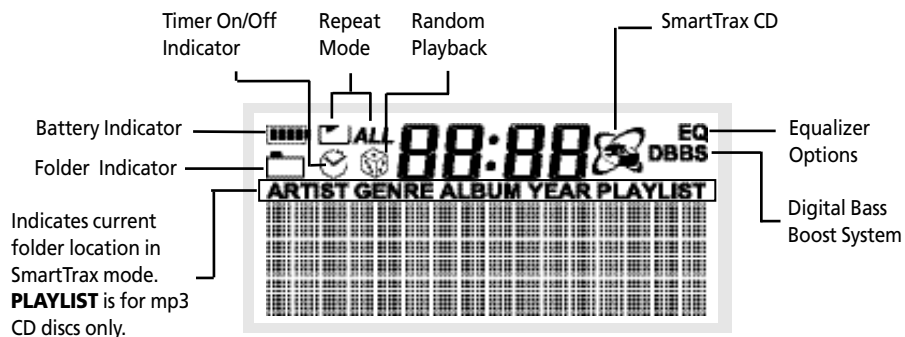

Note:
LCD backlight will be activated whenever the unit is powered on, in order to give you a clear sight of the LCD.

Clock and Timer Setting

EN

Setting Clock

1. Press and hold **CLOCK** on the main unit until the clock and timer setting menu show on the display

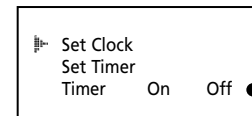

2. Press **PRESET** or to scroll the menu to select Set Clock.

3. Press **ENTER** or **TUNE** to enter clock setting menu. New Time hour will be flashing.

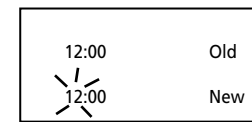

4. Press **PRESET** or to select hour.

5. Press **ENTER** or **TUNE** to move to minutes setting. The minutes digits will flash.

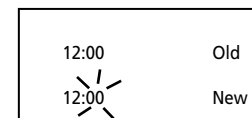

Press **TUNE** to move back to change the hour.

6. Press **PRESET** or to select minutes.

7. Press **ENTER** to save settings and exit clock setting mode.

Tip:
• Press **CLOCK** while the power is on to view current clock time.
• Press **TUNE** or **TUNE** when setting clock to readjust hour or minutes.

Setting Timer

1. Press and hold **CLOCK** on the main unit until the clock and timer setting menu show on the display.

2. Press **PRESET** or to scroll the menu to select Set Timer.

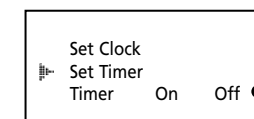

3. Press **ENTER** or **TUNE** to enter Timer setting menu. The Timer-On Time hour flashes on the display.

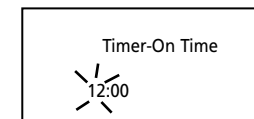

4. Press **PRESET** or to set the hour.

5. Press **ENTER** to move to minutes setting. The minute digits will flash.

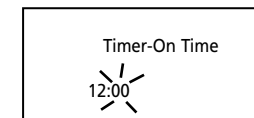

6. Press **PRESET** or to set the minutes.

Tip:
• Press **TUNE** or to toggle between hour and minute setting.

Clock and Timer Setting

EN 7. Press **ENTER** to save timer on time and move to Timer-Off Time setting. The Timer-Off hour flashes.

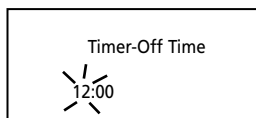

8. Repeat steps 4 to 6 to set the time.

9. Press **ENTER** to save timer off time and move to Timer Source setting.

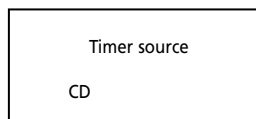

10. Press **PRESET** or **PRESET** to select between CD and RADIO as timer source.

Caution: Ensure the right radio frequency is tuned or CD is loaded before turning off the power.

11. Press **ENTER** to save timer source and move to Timer Volume setting.

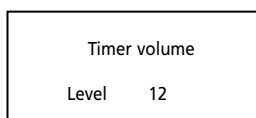

12. Press **PRESET** or **PRESET** to select volume level between 1 to 32.

13. Press **ENTER** to save settings and return to Timer setting menu.

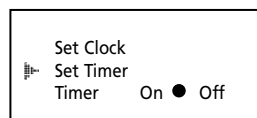

The timer icon will show on the display when timer is activated.

Enable / Disable Timer

1. Press and hold **CLOCK** on the main unit until the clock and timer setting menu show on the display.

2. Press **PRESET** or **PRESET** to scroll the menu to select Timer On/Off.

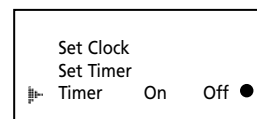

3. Press **ENTER** or **TUNE** to select between Timer On and Off.

Note:
Timer will automatically be activated after Timer settings.

Display Setting

LCD Contrast

1. Press **MODE** in any mode to access Mode menu.

2. Press **PRESET** or **PRESET** to scroll up and down the menu and select System Setting.

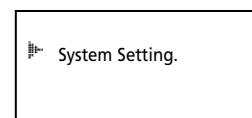

3. Press **ENTER** or **TUNE** to enter and view System Setting menu.

4. Press **PRESET** or **PRESET** to scroll up and down the menu until LCD Contrast is selected.

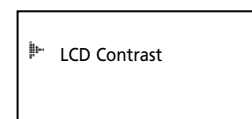

EN 5. Press **ENTER** or **TUNE** to enter LCD Contrast menu.

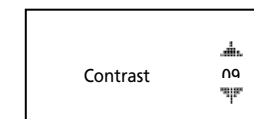

6. Press **PRESET** or **PRESET** to adjust display contrast.

7. Press **TUNE** to exit to the previous menu level.

Sound Features

Volume Control

Press **VOLUME +** on the main unit or **VOL. +** on the remote control to increase volume and **VOLUME -** on the main unit or **VOL. -** on the remote control to decrease volume.

Volume level will show on the display while you are adjusting volume. Minimum volume level is 0 and maximum is 32.

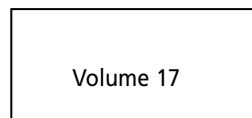

Digital Bass Boost System

Press **SOUND** repeatedly to turn on and off DBBS function. **DBBS** will show on the the display when it is activated.

Boosting the Power

Slide **POWER BOOST** knob to "ON" position on the main unit to activate the power boost function which will enhance the output power of the unit.

Note:
When the **POWER BOOST** function is activated, the unit will consume more power than normal operation. Thus the batteries life might be shortened when using DC power.

Sound Features

EN Equalizer Control

1. Press and hold **SOUND** until the E.Q. menu appears on the display.

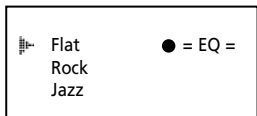

2. Press **PRESET** or to move up and down the E.Q. menu until the cursor points to the desired effect.

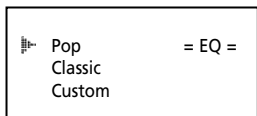
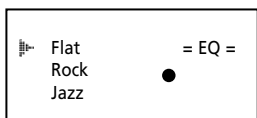

3. Press **ENTER** to confirm your selection.

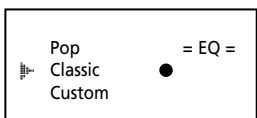

4. Press **TUNE** at anytime to exit E.Q. menu.

Custom Equalizer Setting

1. Press and hold **SOUND** until E.Q. menu appears on the display.

2. Press **PRESET** or to move up or down the menu until the cursor is pointing to Custom.

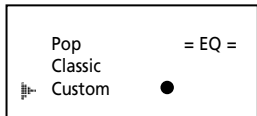
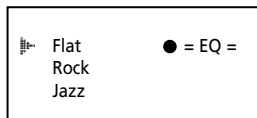

3. Press **ENTER** to select and enter Custom EQ setting.

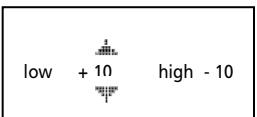

4. Press **PRESET** or to adjust low level.

5. Press **ENTER** to save setting and move on to adjust high level.

6. Press **PRESET** or to adjust high level.

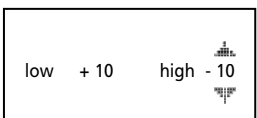

TIP: Press **TUNE** or to toggle between low and high settings.

7. Press **ENTER** to save the setting.

8. Press **TUNE** to exit.

Note: After Custom Setting is finished, the unit will automatically entered Custom EQ if it is not already selected.

Tuner

Enter Tuner Mode

In standby mode, press **FUNCTION/STANDBY** twice to enter radio mode.

If the unit is in CD mode, press **FUNCTION/STANDBY** once to select radio mode.

Tuning to a Station

1. Press **BAND** to select between FM, MW and LW.

2. Press **TUNE** or to tune to the station you want to listen to.



Tip:
 • Extend or reposition the antenna for better FM reception.
 • Move the unit for better MW or LW reception.

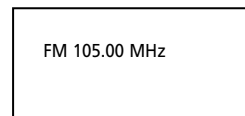

Seek Mode

1. Press /**SEEK** to enable seek function. SEEK will be displayed.

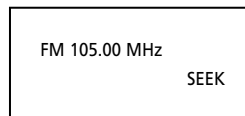

2. Press **TUNE** or to auto search up or down in radio frequency.



Tip: Press /**SEEK** to toggle seek function on and off.

Manual Preset Setting

1. Tune to the frequency to be saved into preset location.

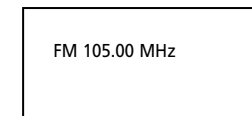

2. Press **ENTER** to enter preset mode. The last used memory location will be displayed.

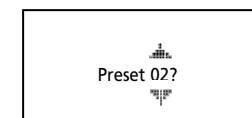

3. Press **PRESET** or to select the highest memory location accessible at the time (the next available memory location).

4. Press **ENTER** to save frequency into selected memory location.



Note: There are 30 preset memory locations in tuner mode.

Preset Memory Recall

1. Press **PRESET** or repeatedly to access desired preset stations.

To overwrite memory locations

1. Tune to the frequency to be saved into preset location.
2. Press **ENTER** to enter preset mode.
3. Press **PRESET** or to select the memory location to overwrite.
4. Press **ENTER** to overwrite the previous setting.

Tuner

EN Delete Preset Station

1. Press **MODE** to enter radio mode menu.

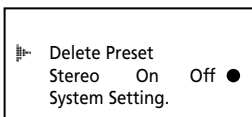

2. Press **PRESET** or to select Delete Preset.

3. Press **ENTER** or **TUNE** to enter Delete Preset menu. All Preset location will be listed.

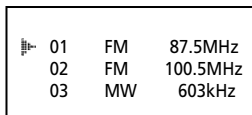

4. Press **PRESET** or to scroll up and down the preset location and select the one you wish to delete.

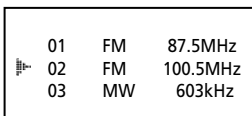

5. Press **ENTER** to delete preset station from the selected memory location. The next preset station will move up to replace the memory location.

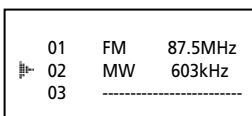

Auto Preset Stations (FM only)

1. Press and hold **BAND** to view Auto Preset menu.

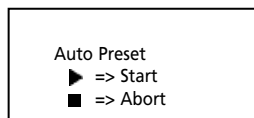

2. Press **PLAY/PAUSE** to start auto preset. Press **STOP** to Abort.

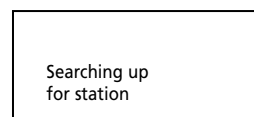
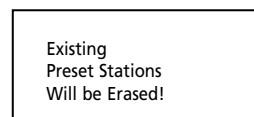

When station is found, it will be stored into Preset.

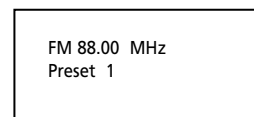

Auto Preset will stop once all 30 preset stations are full or when the frequency band ends.

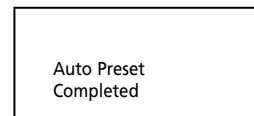

Note:
DO NOT press any key until auto-preset search is complete.

Tuner

FM Stereo

1. Press **MODE** in tuner mode to access the tuner menu.

2. Press **PRESET** or to move up or down the menu until the cursor points to Stereo.

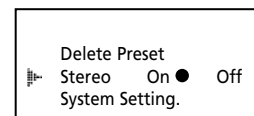

3. Press **ENTER** select between Stereo ON/ OFF.

4. Press **TUNE** to exit Mode menu.

stereo will be displayed when Stereo mode is on and stereo station is received.

mono will be displayed when Stereo mode is off.

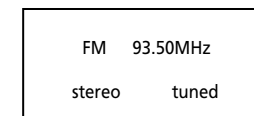

mp3 and CD Player

mp3 Recommendations

- Use .mp3 as the extension when converting audio files into mp3 for saving onto CD-R(W) or CD-ROM, e.g. Rocky08.mp3. Do not use any other extension e.g. .doc, .pdf.
- Do not use the .mp3 or WMA extension for other text or non-audio data files as this may result in serious malfunction and harmful noise interference.
- In order to get audio CD quality, you need to record your mp3 CD at 128 kbps. You can record from 32 kbps to 320kbps.

Entering CD Mode

In standby mode, press **FUNCTION/STANDBY** once to enter CD mode.

In Tuner mode, press **FUNCTION/STANDBY** twice to enter CD mode.

Wait while the CD is being read.

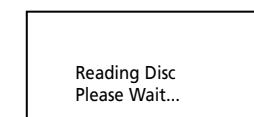

Inserting Disc

1. Press **OPEN** on the unit to open the CD compartment door.

2. Insert the disc

3. Close the compartment door and push down on the door until it locks in place.

Note:
If the disc has an error or if there is no disc on the disc tray, the system will take a long time for reading. If there is no disc on the disc tray, NO DISC will be displayed

Note:
The unit will automatically power off if no function is initiated for more than 30 minutes.

mp3 and CD Player

EN Playing CD Discs

Press **PLAY/PAUSE** to start playback.

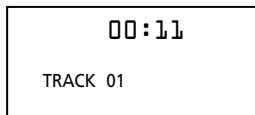

Press **PLAY/PAUSE** when the disc is playing to pause playback. The playback time will flash. Press again to resume.

Note:
When the unit is in pause mode for more than 5 minutes, the unit will automatically enter Stop mode.

Skip and Search Tracks

- Press **TUNE** to go back to the previous track. Press and hold the button to search back in a song.
- Press **TUNE** to go to the next track. Press and hold to search forward in a song.

Stop Playback

Press **STOP** to end playback.

Tip:
To listen to CD through headphones, insert your headphones into the PHONES jack on the back of the player.

Playback Mode

1. Press **MODE** to view the CD mode menu.

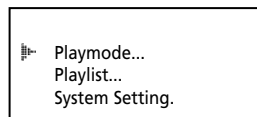

2. In CD mode menu, press **PRESET** or to move up or down the menu until the cursor is pointing to the Playmode... option.

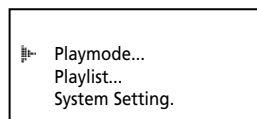

3. Press **ENTER** or **TUNE** to enter Playmode... menu.

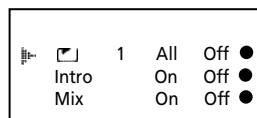

4. Press **PRESET** or to move up or down the menu until the cursor is pointing to the playback mode option you want.

5. Press **TUNE** to return to the previous menu.

mp3 and CD Player

Repeat

1. Select the Repeat option in Playmode... menu.



2. Press **ENTER** to select between
- 1 - To repeat selected track. This display will show 1.
 - All - To repeat entire disc. The display will show ALL.
 - OFF - Turn off the repeat feature.

Sampling Tracks

Activating **Intro** will play the first 10 seconds of each track on the disc.

1. Select the Intro option in Playmode... menu.

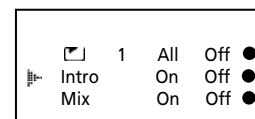

2. Press **ENTER** to select between Intro On and Intro Off.

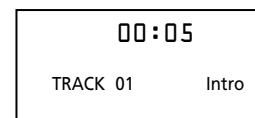

Tip:
When in Intro mode playback, press **PLAY/PAUSE** to disable Intro and continue with normal play.

Random Playback

Enable mix play to randomly play tracks on the disc.

Press Random button to enable and disable random playback.

Enable Random Playback from Playmode menu

1. Select the Mix option in Playmode... menu.

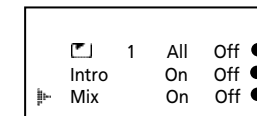

2. Press **ENTER** to select between Mix On and Mix Off.

The random playback icon will show on the display when it is activated.

mp3 and CD Playback

EN Program Playlist

1. Press **MODE** to view the CD mode menu.

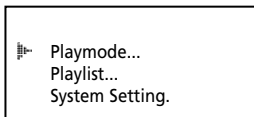

2. In CD mode menu, press **PRESET** or to move up or down the menu until the cursor is pointing to Playlist..

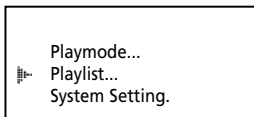

3. Press **ENTER** or **TUNE** to enter Playlist.... menu.

4. Press **PRESET** or to move up or down the menu until the cursor is pointing to the option you want.
When creating program playlist for the first time, only Add Song is available for selection.

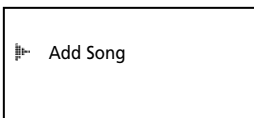

If a playlist already exists, the following options can be selected.

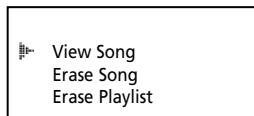
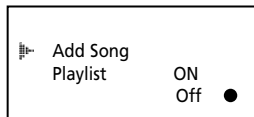

5. Press **ENTER** or **TUNE** to enter selected menu.

6. Press **MODE** to quit.

Add Songs to Playlist

1. Follow steps under Program Playlist and select Add Song in step 4.

2. Press **TUNE** or to select track number for the next available program location.

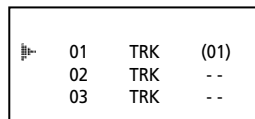

3. Press **ENTER** to save setting and move on to select track for next memory location.

4. Press **MODE** to quit.

There are 30 program memory locations available.

Edit Playlist

1. Follow steps under Program Playlist and select Add Song in step 4.

2. Press **PRESET** or to select the program location you want to edit.

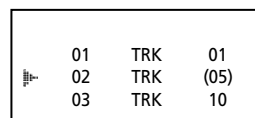

3. Press **TUNE** or to select the new track number.

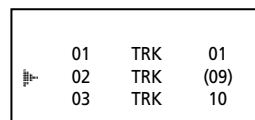

mp3 and CD Playback

4. Press **ENTER** to save new setting.

5. Repeat steps 2 and 4 to edit other program location.

6. Press **MODE** to quit.

Activate Program Playback

1. Follow steps 1 to 4 under Program Playlist and select Playlist in step 4.

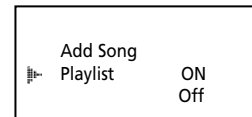

2. Press **ENTER** to select between Playlist On and Playlist Off.

3. Press **MODE** to quit.

View Program Playlist

1. Follow steps 1 to 5 under Program Playlist and select View Song in step 4.

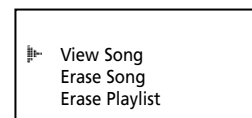

2. Press **PRESET** or to scroll up and down and view Song list.

3. Press **TUNE** to return to the previous menu.

Delete Song from Playlist

1. Follow steps 1 to 5 under Program Playlist and select Erase Song in step 4.

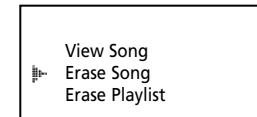

2. Press **PRESET** or to scroll up and down and select the song you want to delete from the list.

3. Press **ENTER** to delete the song.

4. Press **TUNE** to return to the previous menu.

Erase Entire Playlist

1. Follow steps 1 to 5 under Program Playlist and select Erase Playlist in step 4.

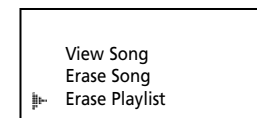

2. Press **ENTER**. You will be asked to confirm or Abort deleting playlist.

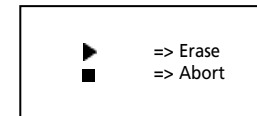

3. Press **PLAY/PAUSE** to confirm and delete playlist.
Press **STOP** to abort selection.

mp3 and CD Playback

EN Playing mp3 Discs

Main mp3 Navigation Keys

PRESET or - to scroll up or down within a directory.

TUNE - to return to the previous menu level.

TUNE - to enter into a selected menu level.

home - to return directly to the home directory



Note:
Must be in STOP mode to view the list of files and folders.

Listening to mp3 and mp3PRO files

mp3PRO is an improved version of the popular mp3 coding-decoding format that provides same sound quality at roughly half the size of original mp3 files. mp3PRO files will play normally on an old mp3 player. Sound quality will only be optimized when mp3PRO files are played on a mp3PRO player.

mp3 CD

When a mp3 audio disc is read, the title of the folder or the song name in the home directory will show on the display.

" " will indicate the title is a folder.

" " will indicate the title is a file.

Folder 1
Folder 2
Track 1
Track 2

Folder – files are divided and placed into individual folder.

File – all files on the mp3 disc will be arranged alphabetically.

Smart Trax

Smart Trax is a music management system that allows for the organization of mp3 or WMA files into 7 standardized categories. The categories include My Selection, Artist, Title, Genre, Year, Album and CD Playlist.

This systematic arrangement shortens the initiation time for mp3 discs. Navigation also becomes easier as files are placed into folders.

If the mp3 disc is formatted with the Smart Trax feature, Folder mode will be replaced with Smart Trax mode.

The Smart Trax icon will show on the display.

Smart Trax - all files are divided into 7 different categories.

My Selection
Artist
Title

Genre
Album
Year

CD Playlist

Clear Selection



Note:
When reading a Smart Trax disc, the unit will automatically enter the Artist Folder. Press home or TUNE to return to the Home Directory.

Respective icons will appear on the display to indicate which SmartTrax folder you are currently in during navigation.

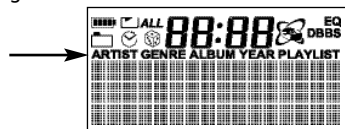

mp3 and CD Playback

Display Options

1. In STOP mode, press **MODE** to view mp3 menu.

Playmode...
System Setting.

2. Press **PRESET** or to scroll down until the icon is pointing to System Setting and press **ENTER** to view mp3 System Setting menu.

3. Press **PRESET** or until the icon is at Browse Mode....

LCD Contrast
Browse mode

4. Press **ENTER** to view Browse Mode selections.

5. Press **PRESET** or to select among display options:
mp3 CD without Smart Trax

Folder mode
File mode

mp3 CD with Smart Trax

Folder mode
File mode
Smarttrax mode

6. Press **ENTER** to confirm selection.

Playing mp3 CD Discs

Use the navigation buttons to select the file or folder to be played.

When a file is selected, playback begins from that file.

When a folder is selected, playback begins from the first song in the selected folder.

Press **PLAY/PAUSE** to start playback.

00:11
File Name
Artist:
Artist 1

The display will toggle among Artist, Type, Year, Genre, Title and Album information every 20 seconds.



Tip:
Press **PRESET** or can also toggle among Artist, Type, Year, Genre, Title and Album.

Press **PLAY/PAUSE** when the disc is playing to pause playback. The playback time will flash. Press again to resume.



Note:
When the unit is in pause mode for more than 5 minutes, the unit will automatically enter Stop mode.

Skip and Search Tracks

• Press **TUNE** to go back to the previous track. Press and hold the button to search back in a song.

• Press **TUNE** to go to the next track. Press and hold to search forward in a song.

Stop Playback

Press **STOP** to end playback.

mp3 and CD Playback

EN mp3 Playback Mode

Follow the steps under Playback Mode on page 12 to access mp3 menu.

SmartTrax mode

If the cursor is at the middle level where all the artists are listed, then the selected artist is picked and his/her songs will be played randomly before picking another artist randomly.

Repeat for mp3 Discs

1. Select the Repeat option in Playmode... menu.

| | | | | |
|--|-------|-----|-----|--------------------------|
| | 1 | All | Off | <input type="checkbox"/> |
| | Intro | On | Off | <input type="checkbox"/> |
| | Mix | On | Off | <input type="checkbox"/> |

2. Press **ENTER** to select between

- 1 - To repeat selected track. This display will show .
- 1 - To repeat selected folder. The display will show . (For mp3 Folder mode only)
- All - To repeat entire disc. The display will show ALL.
- OFF - Turn off the repeat feature



Note:

When repeat folder is selected, the folder where playback begins or the folder where repeat folder is activated will be repeated.

3. Press **PRESET** or to select other features in mp3 menu or press **TUNE** to exit the menu.

Random mp3 Playback

Refer to Random Playback on page 13 for instruction on enabling and disabling random playback.



Note:

Go into the target folder to be repeated or the folder to be played randomly in stop mode.

Sampling mp3 Tracks

Refer to Sampling Tracks on page 13 for details.

mp3 Program Playlist

Refer to Program Playlist on page 14 to access Playlist menu.

Add Songs to Playlist

1. Follow steps under Playlist and select Add Song in step 4.
2. Use the navigation keys to select the item to be added into the playlist.
3. Once the item is selected, press **ENTER** to add it into the next available program location. The program location and the added item will show briefly on the display.

| | |
|----|--------|
| 01 | Item 1 |
| 02 | Item 2 |
| 03 | -- |

4. Repeat steps 2 and 3 to add additional items into the playlist.
5. Press **MODE** to quit.



Note:

mp3 playlists can not be edited. Refer to page 14-15 for other Playlist details.

mp3 and CD Playback

EN

Navigation Chart

mp3 Audio CD without Smart Trax

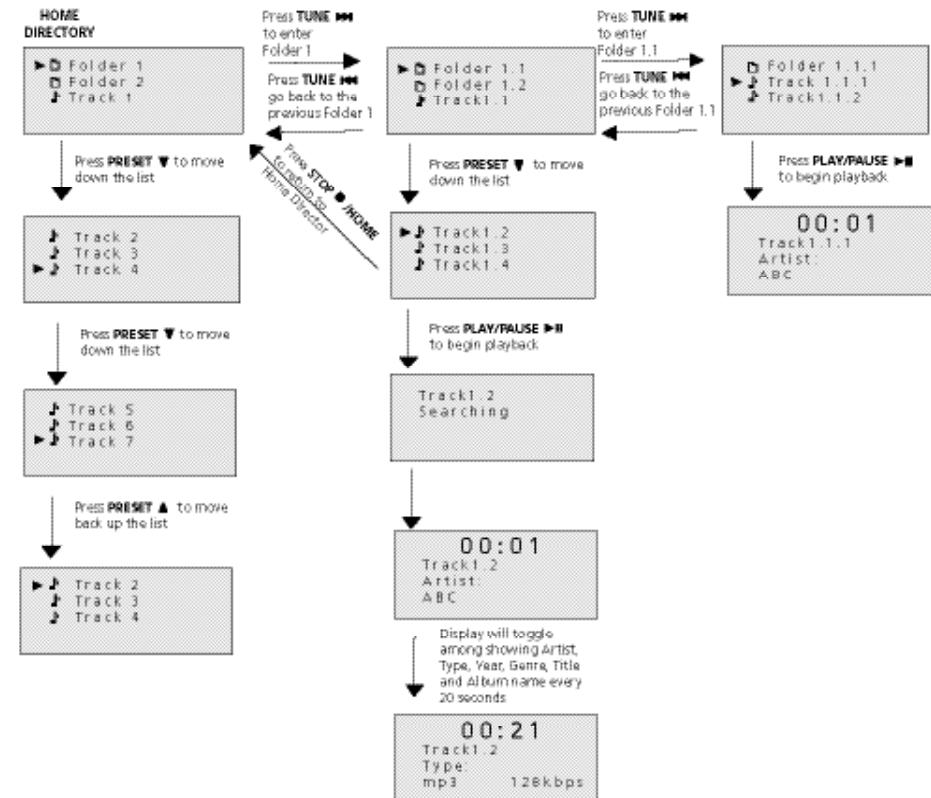

mp3 and CD Playback

EN mp3 Audio CD with Smart Trax

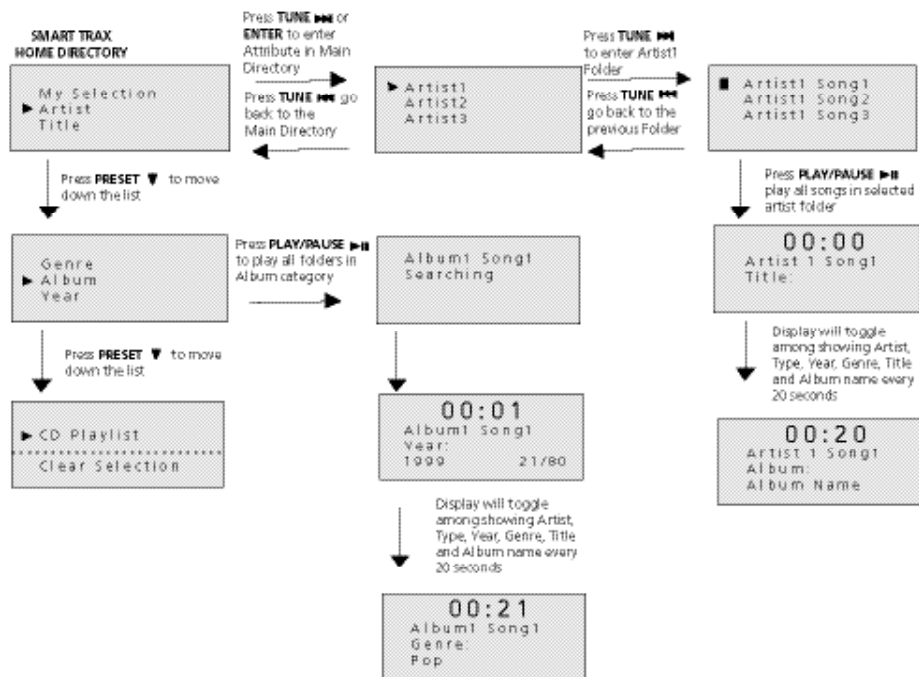

Note:
When you press PLAY/PAUSE in the Smart Trax Home Directory, all songs in the selected category will be played.

When you press PLAY/PAUSE after entering one of the Home Directory categories, only the selected attribute will be played.

For example, if the Artists category is selected, press PLAY/PAUSE and all the songs in the category will be played.

For example, if you are in the Artist category and selected Artist 1 to play, the songs in Artist 1 folder as well as Artist 2,3 and 4 will be played.

mp3 and CD Playback

Additional Smart Trax Features

Smart Trax is only available for mp3 CDs created with this feature. The Smart Trax icon will show on the display.

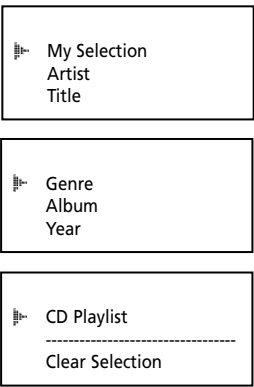

Note:
When reading a Smart Trax disc, the unit will automatically enter the Artist category. Press home or BACK to return to the Home Directory.

My Selection

Selected categories and tracks can be bookmarked and placed into My Selection.

1. Enter Smart Trax mode if the unit is currently in File mode. Follow steps in "Display Options" on pg. 17 to enter Smart Trax mode.

Note:
The unit must be in Smart Trax mode in order to select tracks to be placed in My Selection.

2. Press PRESET or TUNE to scroll the home directory to select the category to enter.
3. Press ENTER or TUNE to enter category.
4. Once you have entered one of the home directory folders,
 - press ENTER to select track(s) to place into My Selection.

- Press TUNE on the main unit or remote control to enter a category.

Note:
 • indicates all tracks in a category have been selected to be placed into My Selection.
 • indicates only certain tracks in the category are selected to be placed into My Selection.



View My Selection

1. Press PRESET or TUNE to scroll the home directory to select the My Selection.



2. Press ENTER or TUNE to enter My Selection.

Clear My Selection

1. Press PRESET or TUNE to scroll the home directory to select the Clear Selection.

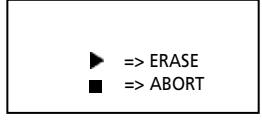

2. Press ENTER to select.
3. Follow the instructions to clear My Selection. Press PLAY/PAUSE to clear all or Press STOP to abort.

Troubleshooting Tips

EN

| Problem | Solution | Problem | Solution |
|------------------------|---|--------------------------------------|--|
| System doesn't turn on | Check power cord for a secure connection. Unplug the unit for a moment, and then plug into power source again. Check the outlet by plugging in another device. | CD button will not respond, | Switch to another function and then back to CD. |
| No sound | Increase the volume setting. Check that you have selected the appropriate function: CD, Tuner. | Remote control does not work | Check that the batteries are properly installed. Replace weak batteries. Check the system is plugged into power source. Point the remote directly at the system's front panel. Move closer to the system. Remove any obstacles between the remote and the system. |
| Poor radio reception | Move antenna for FM reception or rotate unit for better AM reception (MW or LW for Thomson). Turn off nearby electrical appliances, such as hair dryer, vacuum cleaner, microwave, fluorescent lights. | Cannot play mp3 disc | Clean the disc. Make sure files are saved under .mp3 extension. e.g. Rocky08.mp3 Check that the recorded bit rate is within 32kbps and 320kbps. |
| CD does not play | Check that CD is in the tray. Check that CD label is facing up. Check that PAUSE mode is not on. Check that CD function is selected. Use CD lens cleaner. Clean the disc. | Cannot play WMA songs | Check that the WMA bit rate is within 64 kbps and 192 kbps and sampling rate is within 44.1 kHz and 48kHz. |
| CD sound skips | Clean the disc. Check disc for warping, scratches, or other damage. Check if something is causing the system to vibrate. If so, move the system. | Cannot play mp3 PRO songs | Check that the mp3PRO bit rate is within 24kbps and 96kbps and sampling rate is within 44.1 kHz and 48kHz. |
| | | The display shows strange characters | Check that file names are created using the ASCII-ISO 8859-1 (Latin - 1) Table. |

MusicMatch Jukebox Troubleshooting Tips

EN

Problem

Can not burn Smart Trax CD in MusicMatch Jukebox

Solution

You may have exceeded the number of burns.
Upgrade to MusicMatch Jukebox Plus to get unlimited burns.

Check that MusicMatch Jukebox settings are correct.
1. Click the **BURN** button from the Main window to display Burn window.



2. Click the **mp3** button on the top of the Burn window to change to mp3 audio disc.



3. Select **Options** from **Options** menu in the Burn window.



4. Select **Settings** to display Burn settings.



5. Click on the **General** folder. Make sure "mp3 disc" is selected under **Disc type at Startup**.



6. Click on the **mp3** folder. Make sure **Add MultiAudio Tracklist (MAU)** box is checked.
7. Click **OK** when finished.

Maintenance

EN Disconnect the audio system from the power source before performing any maintenance.

Cleaning

Clean the exterior of the system using a soft dust cloth.

CD Player

CAUTION! This system operates with a laser. It must be opened by only a qualified technician.

Handling CDs

- Do not touch the signal surfaces. Hold CDs by the edges, or by one edge and the hole. Do not affix labels or adhesive tapes to the label surfaces. Do not scratch or damage the label. CDs rotate at high speeds inside the player. Do not use damaged (cracked or warped) CDs.

Cleaning CDs

- Dirty CDs can cause poor sound quality. Always keep CDs clean by wiping them gently with a soft cloth from the inner edge toward the outer perimeter.
- If a CD becomes dirty, wet a soft cloth in water, wring it out well, wipe the dirt away gently, and then remove any water drops with a dry cloth.
- Do not use record cleaning sprays or antistatic agents on CDs. Also, never clean CDs with benzene, thinner, or other volatile solvents which may cause damage to disc surface

CD Lens Care

When your CD lens gets dirty it can also cause the system to output poor sound quality. To clean the lens you will need to purchase a CD lens cleaner which can maintain the output sound quality of your system. For instructions on cleaning the CD lens, refer to the ones accompanying the lens cleaner.

More Information

Safety Precautions

- Never open the cabinet under any circumstances. Any repairs or internal adjustments should be made only by a trained technician.
- Never operate this product with the cabinet removed.
- Do not use your System immediately after transporting it from a cold place to a warm place, as condensation may cause the system to malfunction.
- Keep your unit away from humid areas and abnormally hot places.
- Do not touch the player with wet hands. If any liquid enters the player cabinet, take the player to a trained technician for inspection.
- This compact disc player uses a laser to read the music on the disc. The laser mechanism corresponds to the cartridge and stylus of a record player. Although this product incorporates a laser pick-up lens, it is completely safe when operated according to directions.
- Discs rotate at high speed inside the player. Do not use damaged, warped, or cracked discs.
- Do not touch the pick-up lens which is located inside the disc compartment. To keep dust from collecting on the pick-up lens, do not leave the compartment door open for an extended period of time. If the lens becomes dirty, clean it with a soft brush, or use an air blower brush designed for camera lenses.
- The apparatus shall not be exposed to dripping and splashing.

Important Battery Information

- Remove the batteries to avoid leakage if you do not use your remote control for more than one month.
- Discard leaky batteries immediately as leaking batteries may cause skin burns or other personal injuries. Dispose of batteries in the proper manner, according to provincial and local regulations.
- Any battery may leak electrolyte under the following circumstances:

- if mixed with a different battery type,
- if inserted incorrectly,
- if all batteries are not replaced at the same time,
- if disposed of in fire, or
- if an attempt is made to charge a battery not intended to be recharged.

Headset Safety

- Do not play your headset at high volume. Hearing experts warn against extended high-volume play.
- If you experience ringing in your ears, reduce volume or discontinue use.
- You should use with extreme caution or temporarily discontinue use in potentially hazardous situations.

Even if your headset is an open-air designed to let you to hear outside sounds, do not turn up the volume so high that you are unable to hear what is around you.

Don't Infringe

This product should only be used for the purposes for which it is sold, that is, entertainment, violating no copyright law. Any attempts to use this product for which it is not intended is unlawful and therefore not condoned by Thomson.

Technical Specification

Power supply: 230V-50Hz
 Dimensions (H x W x D mm): 145 x 355 x 265
 CD player: Response curve (+/- 2dB): 20Hz to 20 kHz
 Rating Plate: Look for it at the bottom of the set.

The descriptions and characteristics given in this document are given as a general indication and not as a guarantee. In order to provide the highest quality product possible, we reserve the right to make any improvement or modification without prior notice. The English version serves as the final reference on all products and operational details should any discrepancies arise in other languages.

Free Manuals Download Website

<http://myh66.com>

<http://usermanuals.us>

<http://www.somanuals.com>

<http://www.4manuals.cc>

<http://www.manual-lib.com>

<http://www.404manual.com>

<http://www.luxmanual.com>

<http://aubethermostatmanual.com>

Golf course search by state

<http://golfingnear.com>

Email search by domain

<http://emailbydomain.com>

Auto manuals search

<http://auto.somanuals.com>

TV manuals search

<http://tv.somanuals.com>