

Specifications 3

Quick guide 4

[Sockets on the rear of the unit](#) 4

[Mains power and speaker sockets 30LB020S4](#) 4

[Connecting to the mains power supply](#) 4

[Front of TV](#) 4

[Switching on the unit](#) 5

[Selecting TV mode on the remote control](#) 5

[Switching the TV on and to standby mode](#) 5

[Selecting channels](#) 5

[Selecting inputs](#) 5

[Television reception via the antenna cable](#) 5

[Television reception via Scart socket \(e.g. SAT or cable receiver\)](#) 5

Preparations 6

[Setting up, care and maintenance](#) 6

[Place of installation](#) 6

[Cleaning](#) 6

[Instructions for waste disposal](#) 6

[Maintenance](#) 7

[Scope of delivery](#) 7

[Setting up and installing the 30LB020S4](#) 7

[Fitting the base](#) 7

[Fixing and connecting the speakers](#) 7

Connections 8

[Connections](#) 8

[Connection elements on the set](#) 8

[Connection elements on the rear of the unit](#) 8

[Antenna / cable connection](#) 9

[Connecting the headphones](#) 9

[Connecting external auxiliary equipment](#) 9

[Mains connection](#) 9

Operation 10

[Controls](#) 10

[Front of TV](#) 10

[Remote control](#) 10

[Inserting the batteries](#) 10

[Using the remote control for other equipments](#) 11

[Initial startup procedure](#) 13

[Menu navigation](#) 12

[Operation](#) 13

[Switching on/off](#) 13

[Channel selection](#) 13

[Sleep mode](#) 13

[Setting channels](#) 13

[Unit configuration](#) 13

[Storing channels automatically](#) 14

[Direct channel input / fine tuning](#) 14

[Allocating and deleting channels](#) 15

[Picture and sound](#) 15

[Adjusting the picture settings](#) 15

[Adjusting tone settings](#) 16

[Channel-specific settings](#) 16

[The Panorama Sound decoder](#) 17

[The Dolby Virtual Surround Sound Decoder](#) 17

[Decoder mode selection](#) 17

[Normal television sound](#) 17

[Dolby Virtual Surround Sound and Panorama](#) 18

[Special functions](#) 19

[Fade-in display window](#) 19

[The function buttons ...](#) 19

[Timer](#) 19

[Childproof lock](#) 20

[PIC \(Picture in computer\)](#) 20

[Resetting to delivery status](#) 21

[PC mode](#) 21

[Selecting inputs](#) 21

[Setting the language and adjusting screen settings](#) 21

[Teletext](#) 22

[Teletext signals...](#) 22

[Selecting teletext](#) 22

[Page memory facility](#) 22

[Favourite pages](#) 22

[TOP/ FLOF teletext](#) 23

[Multiple pages](#) 23

[Other teletext functions](#) 24

Auxiliary equipment 25

[Auxiliary equipment](#) 25

[Connecting auxiliary equipment](#) 25

[Connecting to external AV sources](#) 25

[Selecting sockets](#) 26

[Additional devices with switching voltage](#) 27

[Copy function / recording via Scart sockets](#) 27

[Assigning the Scart sockets](#) 27

Index 28

En

 **HELPLINE THOMSON**

You can contact THOMSON by dialling: **0871 712 1312**
 (For Great-Britain, all calls will be charged at 0.10 £ / mn)
www.thomson-europe.com

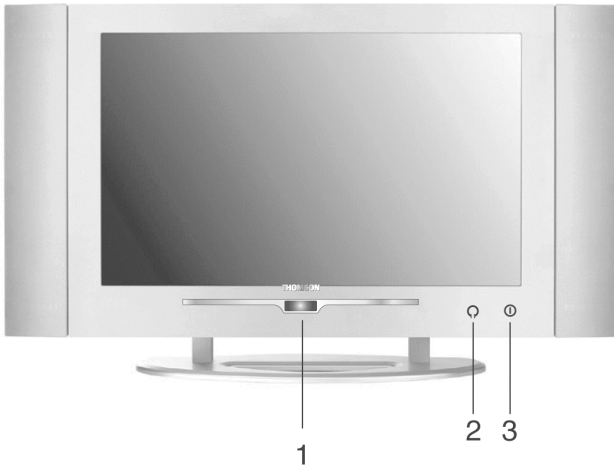

15LB020S4

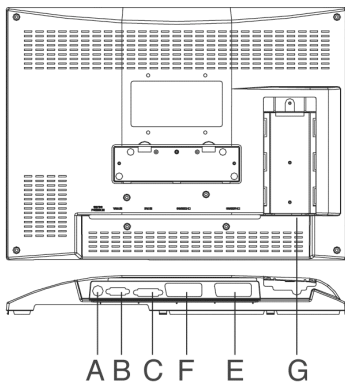

23LB020S4

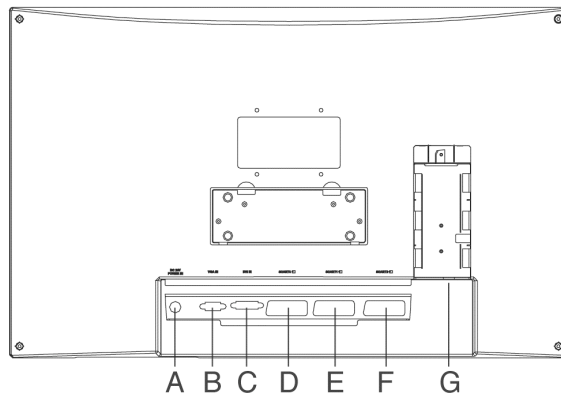

20LB020S4

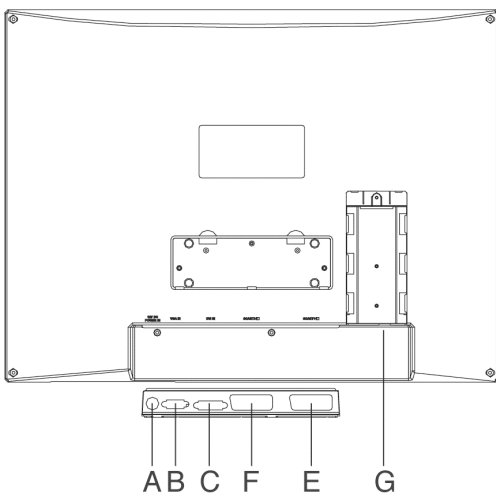

30LB020S4

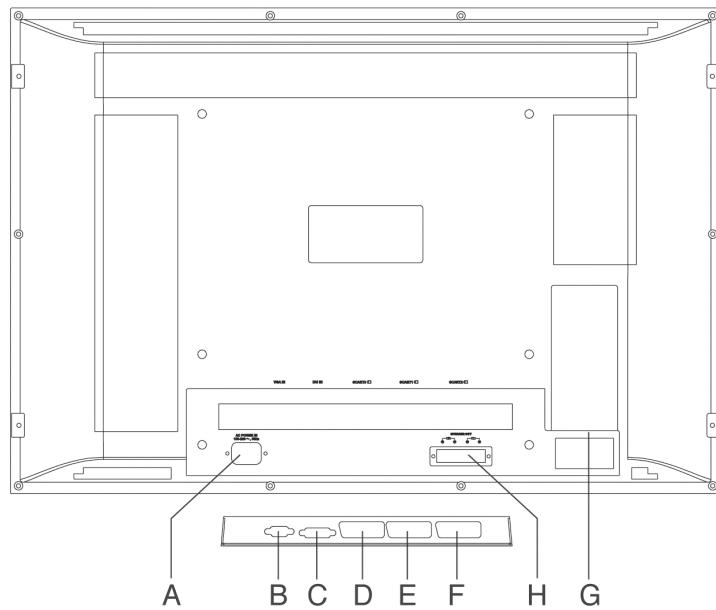

Model *	15LB020S4	20LB020S4	23LB020S4	30LB020S4
General:				
Display	TFT LCD			
Picture format	4:3		16:9	
Screen diagonal	(38 cm)	(51 cm)	(58 cm)	(75 cm)
Picture resolution	1024 x 768 (XGA)	640 x 480 (VGA)	1280 x 768 (WXGA)	1280 x 768 (WXGA)
Pixel pitch (mm)	0.300 x 0.300	0.6375 x 0.6375	0.1305 x 0.3915	0.5025 x 0.1675
Brightness	400 cd/m ²	450 cd/m ²	450 cd/m ²	450 cd/m ²
Contrast ratio	350:1	400:1	400:1	350:1
Channel memory	99 + 2	99 + 2	99 + 3	99 + 3
Tuner **	PAL-SECAM B/G,D/K,I,L/L', NTSC playback 3.58 MHz, 4.43 MHz			
Tuning	Automatic transmitter memory			
Audio	A2/NICAM stereo			
Dolby Virtual Surround Sound	4			
Teletext memory	100 pages, TOP/FLOF text	500 pages, TOP/FLOF text		
Removable loudspeakers	No			4
Removable base	4			
Microsoft Windows compatible	4			
MAC OS compatible	4			
Sockets:				
Headphones	4			
Antenna (75 Ohm)	4			
Scart sockets	2		3	
DVI In	4			
PC In (15-pin D-Sub)	4			
Speaker Out	No			4
DC In	4			No
Power supply	External power pack 12 V DC		External power pack 24 V DC	Integral power pack

* The TV type is clearly visible on the type plate located on the rear of the unit, e.g.:

Type:	15LB020S4
-------	-----------



Note:

Statistically speaking, every display or flat screen has a certain number of faulty pixels. From a production viewpoint, this is unavoidable. No manufacturer can guarantee 100% faultless screens, even with the strictest quality controls.

** The TV standard is clearly visible on the type plate located on the rear of the unit:

Type: .../P	PAL B/G	
	NTSC playback	3.58 MHz
		4.43 MHz

Type: .../..	NICAM B/G, I, L	
	SECAM B/G, D/K, L, L'	
	NICAM B/G, I, L	
	NTSC playback	3.58 MHz
		4.43 MHz

En

Quick guide

Sockets on the rear of the unit

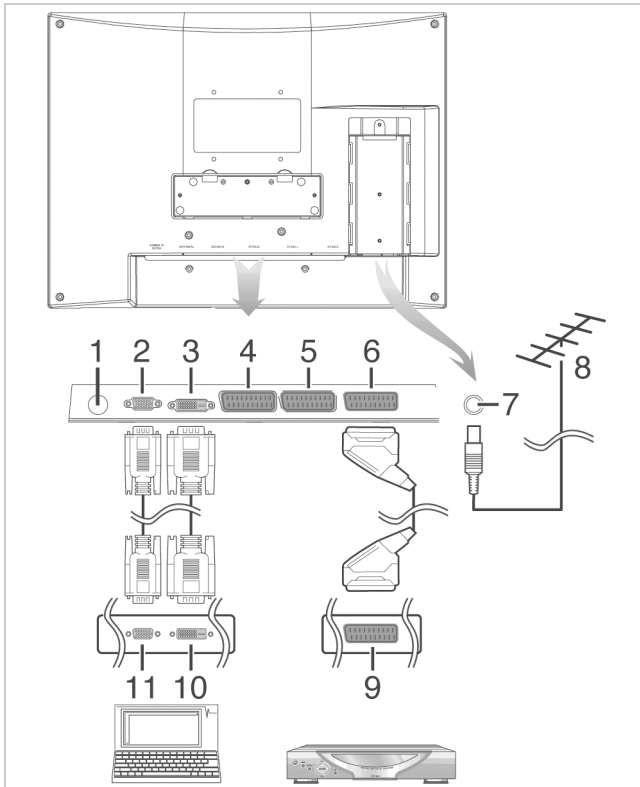

Item	Designation
1	Socket for power pack (not with 30LB020S4)
2	VGA input socket
3	DVI input socket
4	Scart 3 socket (only 23LB020S4 and 30LB020S4) Input only
5	Scart 2 socket Input only
6	Scart 1 socket Input and output
7	Socket for antenna cable (75 ohm)
8	Domestic antenna or cable system
9	Scart output socket e.g. for a SAT receiver
10	DVI output socket e.g. for a PC, DVD player
11	VGA output socket e.g. for a PC

Mains power and speaker sockets 30LB020S4

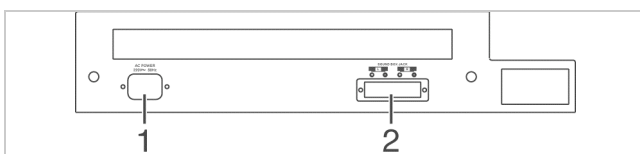

Item	Designation
1	Mains connection socket
2	Speaker socket (left +, left -, right -, right +)

Connecting to the mains power supply

15LB020S4, 20LB020S4, 23LB020S4	30LB020S4
1. Plug the mains cable into the power pack	1. Plug the mains cable into the mains socket on the TV
2. Plug the cable on the power pack into the TV	2. Plug the mains cable into the socket
3. Plug the mains cable into the socket	

Note:
Always use power packs that are supplied by the manufacturer to avoid invalidating the warranty.

Front of TV

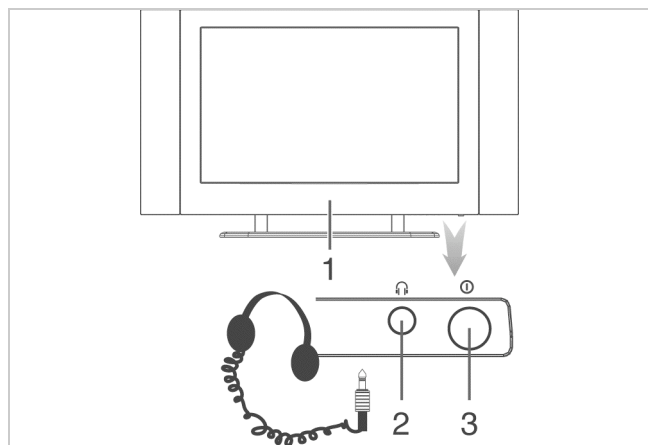

Item	Designation
1	Remote control receiver and standby indicator
2	Headphone socket (3.5 mm jack)
3	Power switch

Switching on the unit

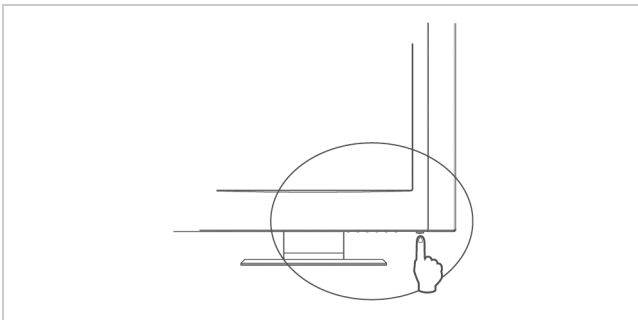

Selecting TV mode on the remote control

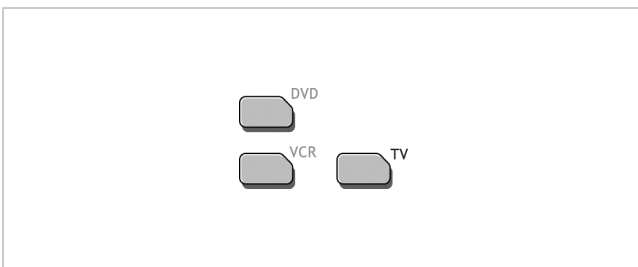

Switching the TV on and to standby mode



Selecting channels



Selecting inputs

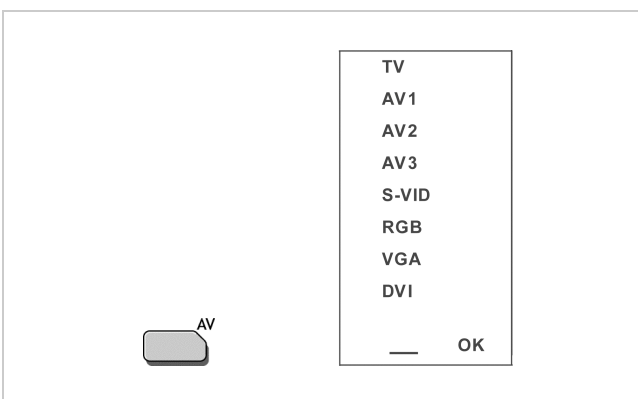

1. Select the input using arrow buttons ▲/▼.
2. Press the **OK** button 24 to store the setting.

TV	Antenna (75 Ohm)
AV 1	Signal input and output
AV 2	Signal input
AV 3	Signal input (only 23LB020S4 and 30LB020S4)
S-VHS	S-VHS input (via Scart 2)
RGB	Signal with maximum picture quality (via Scart 1)
VGA	VGA input
DVI	DVI input

Television reception via the antenna cable

1. Connect domestic antenna or cable system (see no. 7 Sockets on the rear of the unit page 4).
2. Connect TV set to the power supply (see Connecting to the mains power supply page 4).
3. Select TV input (see Selecting sockets page 26).
4. Start automatic search (see Initial startup procedure page 13).
5. Select channels: use the arrow buttons ▲/▼ or numerical buttons 28 (see Channel selection page 13).

Television reception via Scart socket (e.g. SAT or cable receiver)

1. Connect SAT receiver (see no. 4, 5 or 6 Sockets on the rear of the unit page 4).
2. Connect TV set to the power supply (see Connecting to the mains power supply page 4).
3. Select Scart input (AV 1, AV 2 or AV 3, see Selecting sockets page 26).
Usually the Scart input is assigned to the first TV channel position and adjusted via the arrow buttons ▲/▼.
4. Set up and switch on SAT receiver (see SAT receiver instruction manual).
5. Select channels:
Do **not** use **PR +/-** buttons or numerical buttons, instead use the SAT receiver (see SAT receiver instruction manual).



Note:

If the television reception is input via a SAT receiver and the channel position in the TV changes, the correct Scart input must be assigned to the new channel position (see Point 3).

Setting up, care and maintenance

Place of installation

**Caution!**

Protect the television against humidity and rain. The TV set should not be operated in rooms with high moisture levels. Do not place receptacles containing water on the TV, e.g. vases, flower pots. The combination of electrical current and water can cause fatal electric shocks.

Make sure that no objects can fall through the ventilation slits into the interior of the television as they may touch live parts.

Should any liquids or foreign objects fall into the interior of the television, disconnect the television from the power supply immediately. Have the television checked by a specialist before using it again.

**Note:**

If the television is moved from a cold to a warm place, condensation may develop inside the television. Leave the television switched off for a few hours.

Moisture in rooms where the set is installed should not exceed 85% humidity.

**Caution!**

Make sure that the unit (most importantly the screen) does not come into contact with hard objects, especially during transportation!

The place of installation should provide a stable, horizontal, vibration-free surface to ensure that the television stands safely and is not exposed to any vibrations. Vibrations could damage the sensitive electronics.

Any warmth generated when the television is operated must be allowed to escape freely. The ventilation slits on the reverse side must always be kept free. Do not cover the ventilation openings with curtains, cloths or newspapers.

Avoid direct thermal effects from radiators or sunlight. If in doubt, consult a specialist dealer. Heat build-up may cause electronic components to fail!

The maximum ambient temperature should not exceed 35^o celsius.

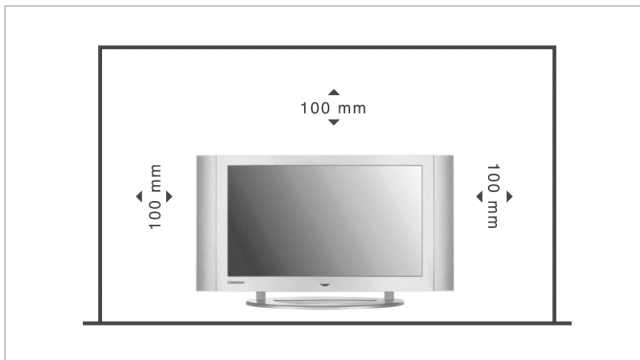

Position the TV in such a way that bright light or sunshine cannot fall onto the screen. Light sources of this kind will reflect off the screen and interfere with the brilliance of the picture.

Do not install the television set near equipment generating strong magnetic fields (e.g. motors, loudspeakers, transformers, etc.) as these may cause colour changes on the screen.

**Caution!**

Viewers should maintain a distance of 2-3 metres (4 times the diagonal of the image) from the screen to protect their eyes while watching television.

Cleaning

**Caution!**

Disconnect the mains plug before cleaning.

- Do not expose the surface of the screen to temperatures above + 80 °C and below – 40 °C!
Protect the television against extreme humidity.
- Do not write on the surface of the screen with a biro or felt-tip pen!
- Only use a cotton cloth to clean the screen.
- If necessary, use a cotton cloth and small quantities of diluted, non-alkaline soapy solution that is water-based or alcohol-based.
- Do not use any of the following substances:
Salt water, insecticide, chlorine or acidic solvents (ammonium chloride), scouring powder.
- Gently clean the surface with the cotton cloth until it is dry.

**Caution!**

Never

- wipe the screen using window cleaner
- treat with foam products
- clean by polishing or scouring.

Instructions for waste disposal

Packaging and packaging aids can and always should be recycled.

**Caution!**

Packaging materials, such as e.g. foil bags, must be kept away from children (**Danger of suffocation!**).

**Note:**

Before disposing of the unit, please remove any batteries! The unit and batteries can be handed in at a collection point for hazardous waste or at your local recycling centre, for example. Please consult your local authority!

Maintenance

Electronic components are subject to a natural ageing process. In the event of malfunctions, please consult a specialist dealer. Only use the original packaging for transporting the unit.



Caution!

The unit is operated at dangerous voltages. The unit may only be opened by an authorised specialist. All maintenance and servicing work must be carried out by an authorised company. Repairs that are carried out incorrectly could result in fatal injuries to the user.

Unauthorised tampering with the inside of the TV invalidates the warranty.



Note:

To make it easier to identify your television when handed over to customer services, state the identification number printed on the type plate on the rear of the unit.

The manufacturer shall not warrant for any damage caused by improper maintenance and repair work by third parties.



Caution, risk of burning-in!

Reproducing a still image for longer periods has a negative effect on the picture quality. Burn-in images and permanent effects on the screen can be avoided by implementing a series of basic precautionary measures. Observing the following recommendations will ensure that the television delivers satisfactory results in the long term:

Avoid frequent playback of the same image and moving images with static areas (e.g. fixed fade-ins in the image or video games with areas that do not move).



Do not view the same teletext page for long periods.

Avoid playing back on-screen fade-ins from a decoder, DVD player, video recorder or other equipment for long periods.

When you use the freeze-frame function on a television, video recorder, DVD player or other equipment, do not leave the picture on freeze-frame or pause for long periods.

Pictures with extremely light and extremely dark areas beside one another should not be played back for long periods.

After use, always switch the display back to standby mode!

Scope of delivery

- 1 x LCD TV
- 1 x power pack (not with 30LB020S4)
- 1 x mains cable
- 1 x base (with LCD TV 30LB020S4, not preassembled)
- 1 x remote control
- 2 x batteries AAA 1.5 volt for remote control
- 1 x antenna cable
- 2 x speakers (only 30LB020S4)
- 2 x speaker cable (only 30LB020S4)
- 1 x instruction manual

Setting up and installing the 30LB020S4

To set up the 30LB020S4 LCD TV, please proceed as follows:

Fitting the base

- Fit the base to the rear of the unit using the screws (x 4) supplied.
- Check that the screws are seated correctly.

Fixing and connecting the speakers



Note:

Only the speakers supplied should be connected to the television.

- Fix the speakers supplied to the housing using the screws provided (2 for each speaker). Or position them in the desired location around the television.
- Connect the speakers to the terminal connectors on the rear of the unit. Press down the terminal levers to plug in the speaker cables. Use the speaker cables supplied and make sure that they are connected correctly (left +, left -, right +, right -). The black wire in the speaker cable must be secured to the black (-) terminal on the television. The second wire must be connected in the same way.

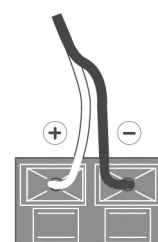

Note:

Only plug in the stripped end of the speaker cable!

Connections

Connections

See Overview on page 3.

Connection elements on the set

Item	Designation
2	Headphone socket for connecting headphones with a 3.5 mm jack

Connection elements on the rear of the unit

15LB020S4

Item	Designation
A	DC IN: Connecting the external power pack (12 V DC) to the power supply
B	VGA IN: Connecting a PC via a VGA cable
C	DVI IN: Connecting a PC or similar via a DVI cable
E	Scart 1: Scart socket (EURO-AV) for RGB input and AV signal input / output (picture and sound)
F	Scart 2: Scart socket (EURO-AV) for AV signal input (picture and sound) and S-VHS input
G	ANTENNA 75 \square : Connection for 75-ohm antenna/cable system

20LB020S4

Item	Designation
A	DC IN: Connecting the external power pack (12 V DC) to the power supply
B	VGA IN: Connecting a PC via a VGA cable
C	DVI IN: Connecting a PC or similar via a DVI cable
E	Scart 1: Scart socket (EURO-AV) for RGB input and AV signal input / output (picture and sound)
F	Scart 2: Scart socket (EURO-AV) for AV signal input (picture and sound) and S-VHS input
G	ANTENNA 75 \square : Connection for 75-ohm antenna/cable system

23LB020S4

Item	Designation
A	DC IN: Connecting the external power pack (24 V DC) to the power supply
B	VGA IN: Connecting a PC or similar via a VGA cable
C	DVI IN: Connecting a PC or similar via a DVI cable
D	Scart 3: Scart socket (EURO-AV) for AV signal input (picture and sound)
E	Scart 1: Scart socket (EURO-AV) for RGB input and AV signal input / output (picture and sound)
F	Scart 2: Scart socket (EURO-AV) for AV signal input (picture and sound) and S-VHS input
G	ANTENNA 75 \square : Connection for 75-ohm antenna/cable system

30LB020S4

Item	Designation
A	AC IN: Connecting the integral power pack to the power supply via the mains cable
B	VGA IN: Connecting a PC via a VGA cable
C	DVI IN: Connecting a PC or similar via a DVI cable
D	Scart 3: Scart socket (EURO-AV) for AV signal input (picture and sound)
E	Scart 1: Scart socket (EURO-AV) for RGB input and AV signal input / output (picture and sound)
F	Scart 2: Scart socket (EURO-AV) for AV signal input (picture and sound) and S-VHS input
G	ANTENNA 75 \square : Connection for 75-ohm antenna/cable system
H	SPEAKER OUT: Terminal connectors for external speakers

Antenna / cable connection

Your unit is supplied with a high-grade antenna cable with high shielding degree.

To connect the domestic antenna or cable system, plug this cable into the socket for the external antenna and the output socket on the television. Avoid cable looping near the TV set for optimum reception.

If a video recorder or satellite receiver is to be connected up, please refer to Auxiliary equipment on page 25.

Connecting the headphones

Connection socket 2 is supplied for all normal headphones sold with a 3.5 mm jack. For other jacks, use adapters available from specialised stores.

 **Note:**
Integral speakers are switched off when headphones are used.

 **Caution!**
Excessively high volumes can damage your hearing, especially when wearing headphones.

Connecting external auxiliary equipment

Scart sockets D, E and F on the back of the unit offer extensive connection options. To connect external equipment, see page 25.

 **Note:**
The menu and teletext displays are not available from the Scart sockets as an output signal and cannot be picked up as a result.

Mains connection

 **Caution!**
The unit should only be connected to the mains supply once all other connections have been made. When disconnecting the mains cable from the socket, pull on the mains plug and **not** on the cable.

 **Caution!**
The LCD TV 30LB020S4 should only be connected to a power supply voltage of 230 V / 50 Hz with a protective earth conductor.

15LB020S4, 20LB020S4, 23LB020S4	30LB020S4
1. Connect mains cable to power pack	1. Plug the mains cable into the mains socket on the TV
2. Plug the cable on the power pack into the TV	2. Plug the mains cable into the socket
3. Plug the mains cable into the socket	

 **Caution!**
If the mains plug on the TV power cable is faulty or if the unit shows other signs of damage, it should not be used.
Remove the mains cable from the socket by pulling out at the plug – do not pull on the cable.

 **Note:**
Always use power packs that are supplied by the manufacturer to avoid invalidating the warranty.

 **Caution!**
Use an appropriate power supply and avoid using multiple socket outlets!
To avoid damage caused by thunderstorms, pull out the mains and antenna sockets during the storm.
Do not touch power supply plugs with wet hands - risk of electric shocks!

En

Controls

Front of TV

Item	Designation
1	Remote control receiver and standby indicator
2	Headphones socket
3	Power switch





Remote control



If the equipment is operated with the remote control, observe the following:

The supplied remote control can control up to five different devices:

TV, VCR, DVD. To operate the device, press the **TV** button:

- Point the remote control (transmitter) at remote control receiver 1 on the unit.
- An optical connection must be established between the transmitter and the receiver.
- If the range of the remote control decreases, replace the batteries.

Item	Designation
	Switches off the TV temporarily (ready for operation); the red standby indicator 1 lights up. Press the button again to switch the TV back on.
PR+/- 	Switching through each individual channel position.
RETURN	No function
MENU	Displays the menus
	To select menu options.
	To select the picture format in TV mode.
Purple key	For changing to teletext mode.
Blue key	To scroll TV channels in the PIP picture.
0	Number buttons for
-	- selecting channel position
9	- entering values in the menus.
F1-F2 F3-F4	Can be set for various functions.
Yellow key	To display / increase / erase PIP picture.
Green key	- Opening the Sound menu. - Scrolling forwards page by page in teletext mode. - To scroll AV programmes in the PIP picture.
Red key	- Opening the Picture menu. - Scrolling back page by page in teletext mode. - To change PIP position.

Item	Designation
	To set functions, change values, enable and disable functions.
OK	Memory / confirm button
EXIT	To quit - the menus. - Teletext.
INFO	Status information on the current channel.
	Volume setting.
	For switching off the sound. Pressing the button again switches the sound back on.
TV	To access TV mode.
VCR	To access VCR mode.
DVD	To access DVD mode.

Inserting the batteries

The batteries should be removed if the remote control is not used for long periods. Otherwise, the batteries may leak and damage the remote control.

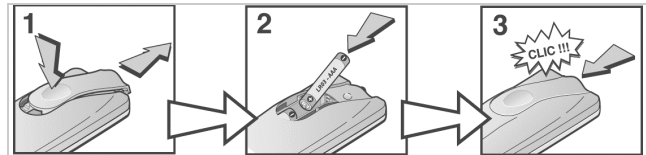

Caution!

The batteries for the remote control should be kept out of the reach of children. Swallowing batteries can seriously damage your health. Standard batteries must not be recharged, heated or exposed to naked flames (**risk of explosion**).

Make your own contribution to protecting the environment!





Note:

Flat batteries and storage batteries should not be disposed of together with standard household waste. They can be deposited at the collection point for used batteries and hazardous waste. Please consult your local authority! It may also be possible to return discharged batteries to a specialist dealer or retailer.

Using the remote control for other equipments



The remote control supplied with your set can be used for other equipment, such as video recorders or DVD players. This page provides information concerning the remote control's use with these types of equipment.

	VCR	DVD
VCR	Press the VCR button	
DVD		Press the DVD button
	On/Standby	On/Standby
MENU	To display the main menu	To display the main menu
	Vertical scrolling in menus	Vertical scrolling in menus
	Horizontal scrolling in menus	Horizontal scrolling in menus
OK	To confirm an action	To confirm an action
EXIT	To close a menu	To close a menu
0-9	To directly access channels or enter numeric values	To enter numeric values or select options in menus
PR+/PR-	To change channels	
AV	To select AV input	
REV	Rewind	Rewind
PLAY	Play	Play
FWD	Fast forward	Fast forward
STOP	Stop	Stop
PAUSE	Pause picture	Pause picture
REC	Record	

Programming the remote control

Automatic code search

This method can be used to automatically find the most appropriate code for your appliance.

1. Switch on the appliance you wish to use the remote control with.
 2. Press the relevant button for this appliance on the remote control, and while holding this button down, press the  standby button until the remote control light comes on. Release the two buttons.
 3. Point the remote control at the appliance and press **PLAY**. Wait until the light stops flashing. If the appliance has not gone into standby mode after five seconds, press the **PLAY** button again to continue the search for the next set of codes. Repeat this operation until the appliance goes into standby mode. There are 20 sets of codes.
 4. When the appliance goes into standby mode, press the standby  button on the right side to switch it on again. Then press the **REV** button to put it back in standby mode, and if necessary, keep pressing until the appliance goes into standby.
 5. Press the **STOP** button and hold it down until the remote control light goes off.
- Note: you can cancel the programming operation at any time by pressing the **EXIT** button.*

Manual programming

This method involves carrying out a manual search for the codes to be used for controlling your other appliances.

1. Switch on the appliance you wish to use the remote control with.
2. Press the relevant button for this appliance on the remote control, and while holding this button down, enter one of the codes relevant to your make of appliance (there is a list of codes at the end of this manual). If the remote control light flashes you have entered the wrong code or it is not possible to program the remote control.
3. Point the remote control at the appliance and press the relevant button (**VCR** or **DVD**). Press the  standby button. If the appliance does not go into standby mode, try another code.

Depending on the year of manufacture and the type of appliance, some functions may not be available. Certain codes may cover more functions than others. Test the functions you can control and, if appropriate, try other codes.

Note here the code(s) which work best.

VCR	<input type="text"/>	<input type="text"/>	<input type="text"/>	<input type="text"/>
DVD	<input type="text"/>	<input type="text"/>	<input type="text"/>	<input type="text"/>

When you **change the remote control's batteries**, remember to **reprogram** it.

Initial startup procedure

When setting up for the first time, proceed as follows:

1. Switch the unit on at the power switch (3). Then press the  button on the remote control. The standby indicator (1) goes out. The following Installation Menu appears on the screen the first time the unit is switched on, or before the first channel is stored:

 **Note:**
Every time the TV is switched on, a starting sequence appears on the screen displayed as a white stripe.

 **Note:**
If for some reason the set has already been switched on, the installation menu no longer appears automatically. If this is the case, to save the station, see page 14.

Country	UK
Language	English
Standard	L
Search	>



First installation.
Launch installation : tasto '>'
Leave : EXIT







For ease of operation, all operating procedures are represented on the screen in MENU form.





Item	Meaning
1	Main menu
2	Submenu
3	Status bar

It is possible to select the language in which the menu is to be displayed. Please read the Unit configuration section on page 13 for information on changing the menu navigation language.

1. The Main menu appears on the left-hand side of the screen when you press **MENU** button. The selected submenu appears to the right next to the Main menu.
2. Use arrow buttons  /  to select the individual menu items.

2. Select the required line by pressing the arrow buttons  /  and change the relevant setting by pressing the arrow buttons  / .
3. Use arrow buttons  /  to move the green marker back to the Search line.





 **Note:**
Before the search is started, the country abbreviation should be entered in the **Country** line and the menu language in the **Language** line.
The **Standard** line should be set to the country-specific TV standard ("UK" for UK).

4. Automatic channel search begins when you press the right-hand arrow button . All detected stations are automatically assigned to the channel positions and stored in ascending order.
5. Press **OK** button to save; the display **Save : OK** appears in red briefly.
6. Press the **EXIT** button to quit the menu.

 **Note:**
Screen settings such as e.g. brightness and contrast were preset by the manufacturer to provide optimised performance. You can change these settings in the Picture menu (see page 15).

Menu navigation

	Menu item	see page
Picture Sound-1 Install. Sound-2 Pr. set. Pref. Timer Lock \$ Reset	Picture	15
	Sound-1	16
	Install.	13
	SOUND-2	17
	Pr. set	16
	Pref.	13
	Timer	19
	Lock \$	20
	Reset	21

3. Press  to advance to the selected submenu (Main menu item is highlighted blue).
4. To return to the Main menu from the various submenus, select **< Return** using the arrow keys  / .
5. Press the arrow key  to access the Main menu (Main menu item is highlighted green).
6. Press **OK** button to save; **Save : OK** appears in red briefly.
7. Press the **EXIT** button to exit the menu.

 **Note:**
The menus disappear automatically after approx. 12 seconds providing no buttons are pressed on the remote control.

Operation

Switching on/off

Actuate power switch (3) to activate standby mode. The standby indicator lights up (1) red. To switch on the device, press the  button on the remote control. The standby indicator 1 goes out.

Press the  button on the remote control to turn the active unit to standby mode. The standby indicator lights up (1) red.



Caution!



Use an appropriate power supply and avoid using multiple socket outlets!

To avoid damage caused by thunderstorms, pull out the mains and antenna sockets during the storm.





Do not touch power supply plugs with wet hands - risk of electric shocks!

Setting channels

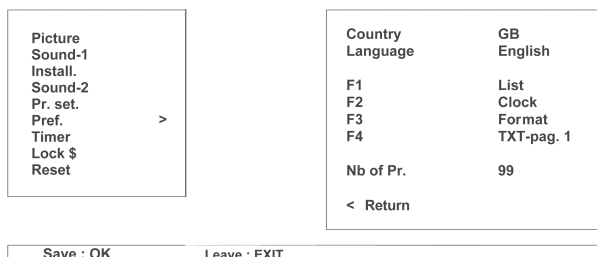



Unit configuration

1. Open the Pref. menu: Press **MENU** button.
2. Select **Pref.** in the Main menu using arrow buttons  / .
3. Press the arrow key  to move the green marker to the Pref. menu.



4. Use arrow buttons  /  to select the individual menu items.
5. Use arrow buttons  /  to modify the relevant settings or data.

Channel selection

- The channels are selected directly by pressing the numeric keys (**0-9**). To select channels with two-digit numbers, press the corresponding numeric keys (**0-9**) in direct succession.
- Pressing arrow buttons  /  selects the channels one by one.
- The channels can also be selected in the channel list. Press the **MENU** button twice, the channel list appears on the screen.
A channel can be selected by pressing arrow buttons  / .

To confirm the channel selected, press **OK** button.

Sleep mode

If Program is no longer received on a certain channel, e.g. after the station signs off or if there is no antenna signal, the unit automatically switches to standby mode after approx. 7 minutes.



Note:

In AV mode (operation of an external device using one of the Scart connection sockets on the rear of the unit), sleep mode is disabled.

6. When channels are stored automatically, they are sorted according to the usual order they are stored in the respective countries. Select the corresponding country in the **Country** line. Select the menu dialogue language in the **Language** menu item.

Various functions can be assigned to buttons **F1-F2-F3-F4** (see also page 19).

The number given in the **Nb of Pr.** line limits the amount of channels when "zapping". Higher channel numbers will therefore be ignored when channels are selected one by one (zapping). These channels can only be selected using the numeric keys (**0-9**) on the remote control and in the channel list.

7. Press the **OK** button to store the settings.
8. Press the **EXIT** button to quit the menu.

Storing channels automatically

1. Open the Install. menu: Press **MENU** button.
2. Select **Install.** in the Main menu using arrow buttons **▲/▼**.
3. Press arrow button **◀/▶** to move the green marker to the Install. menu.
4. Select **Search** using arrow buttons **▲/▼**.

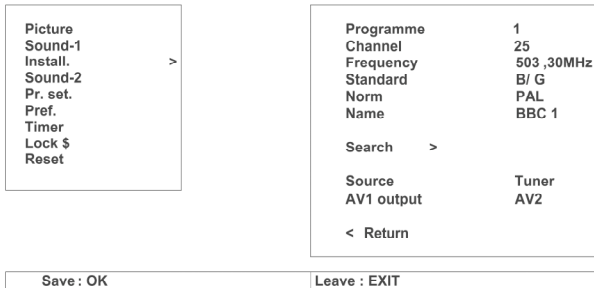

5. Press arrow buttons **◀/▶** to start the search. All stations received are automatically stored in the channel positions in ascending numerical order.
6. Press **EXIT** button to stop the search early.
7. If the video recorder channel position is also to be programmed automatically, then connect the video recorder correctly with the antenna (HF) and play a pre-recorded cassette. Refer to the instruction manual for the video recorder to carry out this procedure.
8. Press **OK** button to save; **Save : OK** appears in red briefly.
9. Press the **EXIT** button to quit the menu.

The station identification abbreviations (Name) can still be modified later.

If the picture is just black/white or there is no sound or interference is evident on some channels, the standard **Standard** and the **Norm** be adjusted accordingly in the Install. menu.

Direct channel input / fine tuning

1. Open the Install. menu: Press **MENU** button.
2. Select **Install.** in the Main menu using arrow buttons **▲/▼**.
3. Press arrow button **◀/▶** to move the green marker to the Install. menu.

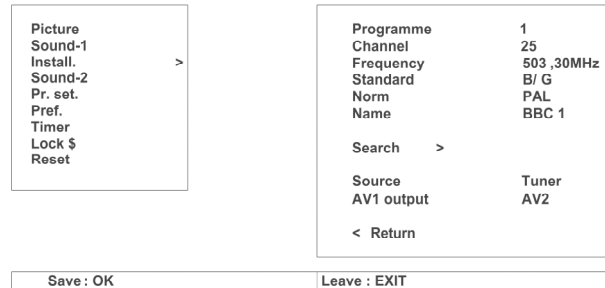

4. Use arrow buttons **▲/▼** to select the individual menu items.
5. Use arrow buttons **◀/▶** to modify the relevant settings or data.
6. Set the channel position to where the TV station is to be stored under **Programme**
7. Direct channel input is carried out in the **Channel** line.
8. Use the button **F1** to select between **S** for special channels and **...** for other channels.
9. The channel number (2-digit) can be entered easily using the numeric buttons (**0-9**);
10. or the channel number can be scrolled through backwards of forwards one by one using the arrow buttons **◀/▶**;
11. For station fine-tuning, select the **Frequency** line using the arrow keys **▲/▼**.
12. You can change the settings in 50 kHz intervals up or down by pressing arrow buttons **◀/▶**.
13. The **Standard** and **Norm** lines should be adapted to the country-specific TV standard.
14. Any channel name (max. 8 digits) can be specified in **Name**. The channel name appears automatically for channels with VPS/PDC.
15. Use arrow buttons **◀/▶** to select the position where the subsequent character (letter, digit, etc.) should be entered.
16. Select the desired symbol using arrow buttons **▲/▼**.
17. Use arrow buttons **◀/▶** to select a new position, etc.

18. If the full channel name is set, quit the entry field using arrow buttons </>.
19. Select **Tuner** in the **Source** menu line for the aerial or cable system stations using the arrow buttons </>.
20. Press the **OK** button to store the settings.
21. To allocate further channels select the channel line again and proceed in the same way.
22. Press the **EXIT** button to quit the menu.

Allocating and deleting channels

1. Press the **MENU** button twice, the Program list appears on the screen.

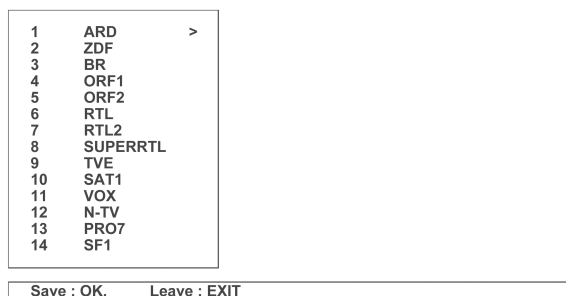

Adjusting the picture settings

Depending upon the room lighting conditions, it may occasionally be necessary to adjust the brightness, contrast or other picture settings.

1. Open the Picture menu: Press **MENU** button. The title **Picture** is highlighted green.
2. Press the arrow button > to move the green marker to the Picture menu.

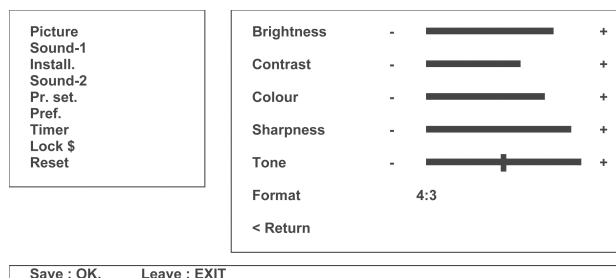

3. Use arrow buttons ▲/▼ to select the individual menu items.
4. Use arrow buttons </> to modify the relevant data. To make modification easier, only the corresponding submenu item appears when you press arrow buttons </>.
5. By pressing **OK** button, all the changes to the picture format are saved.
6. Press the **EXIT** button to quit the menu.

2. Use arrow buttons ▲/▼ to select the channel whose position needs to be changed.
3. Select the channel using right-hand arrow button >.
4. Use arrow buttons ▲/▼ to guide the bar containing the channel name to a new position.
5. Use left-hand arrow button < to store the new channel position in the list.
6. If a channel is in the other bar, it can be deleted by pressing the **OK** button.
7. Press the **EXIT** button to quit the menu.

Picture and sound

Note:
The Picture menu can also be opened by pressing the **red** button. The green marker is already located in the Picture menu here. Press **OK** button to save any changes. The menu automatically disappears approx. 5 seconds after the last input was made.

The **Brightness** and **Contrast** settings are governed by room brightness. The **Colour** setting is based on skin tone. The **Sharpness** setting is a matter of personal preference. The tone can also be adjusted to suit personal preferences. Select between "colder" (□ left) and "warmer" (+ right). Select the desired picture format in **Format**. The television screen can be adjusted to various transmission formats. Make sure the picture geometry is correct.

Adjusting tone settings

1. Open the Sound menu: Press **MENU** button.
2. Select **Sound** in the Main menu using arrow buttons **▲/▼**.
3. Press arrow button **▶** to move the green marker to the Sound menu.

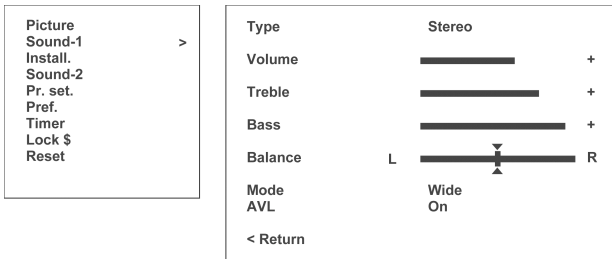

Save : OK. Leave : EXIT

4. If a stereo signal is received, the option of changing between stereo and mono reception is available in the **Normal** sound menu item.
5. Use the arrow keys **▲/▼** to select the menu items **Treble**, **Bass** or **Balance**.
6. **Mode (Wide/Normal)** creates the effect of acoustic base dispersion. This gives the impression that the loud speakers have been moved further apart from each other.
7. **AVL (On/Off)** : AVI (Automatic Volume Levelling) corrects the differences in volume levels between individual television programs and advertisements. If you prefer the fluctuations in volume to remain, for example with music Programs, set the AVL to Off.
8. Use arrow buttons **◀/▶** to modify the relevant data.
9. Press the **OK** button to store the settings.
10. Press the **EXIT** button to quit the menu.

 Note:
The Sound menu can also be opened by pressing **green** button. The green marker is already in the Sound menu. Press **OK** button to save any changes. The menu automatically disappears approx. 5 seconds after the last input was made.

Channel-specific settings

When switching channels there are sometimes differences in volume and contrast. The volume and the contrast can therefore be adjusted individually for each channel position.

1. Select the Pr. set menu: Press **MENU** button.
2. Select **Pr. set** in the Main menu using arrow buttons **▲/▼**.
3. Press arrow button **▶** to move the green marker to the Pr. set menu.

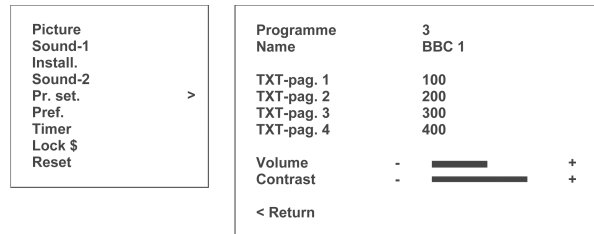

Save : OK. Leave : EXIT

4. Use arrow buttons **▲/▼** to select the individual menu items.
5. Use arrow buttons **◀/▶** to modify the relevant settings or data.
6. Select the channel position from the **Programme** line - the relevant channel name should appear automatically. A total of four favourite teletext pages per channel position can be specified in the lines **TXT-page 1 - 4** by entering the three-digit number of a teletext page. These can then be accessed directly by pressing the **F1-F2-F3[F4]** function buttons (see section The function buttons ... on page 19).
7. In the **Volume** and **Contrast** lines, adjust the values correspondingly using the arrow buttons **◀/▶**.
8. Press the **OK** button to store the settings.
9. Press the **EXIT** button to quit the menu.

The Panorama Sound decoder

"Panorama Sound" achieves a significant improvement of the stereophonic sound with normal playback of stereo sound (2 channels left/right).

The integrated microcomputer ensures that the sound has depth and is three-dimensional, even without additional amplifiers and speakers. Thus the sound becomes "3-D".

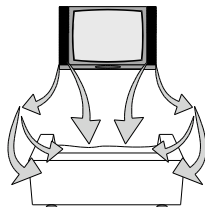

Note: To enjoy video playback with "Panorama Sound", a stereo video recorder is needed.

The Dolby Virtual Surround Sound Decoder

Dolby Virtual Surround Sound is a special method for recording sound which was principally developed for cinema film. In order to use these atmospheric sound effects at home as well, video tapes, television broadcasts and video discs are also produced with this technology.

The integrated Dolby Virtual Surround Sound Decoder reproduces the Dolby Stereo cinema effect on a conventional home entertainment system. On playback of the "Dolby Pro Logic Surround Tone", Dolby Virtual Surround Sound achieves a 3-D sound similar to that of a home theatre system.

Even without additional speakers, the corresponding modification of the sound creates an outstanding surround effect. The listener is surrounded by the sound as if in a concert hall.

When buying video tapes, video discs and CDs, look for the Dolby logo . It indicates that all sound and image carriers have recordings in Dolby Pro Logic Surround quality.

VHS video cassettes only marked with the logo do not contain the necessary Dolby Surround information.



Manufactured under license from Dolby Laboratories. DOLBY, the double-D symbol and PRO LOGIC are trademarks of Dolby Laboratories.

Note: A stereo video recorder is required for recording and playing back films with Dolby Virtual Surround Sound.

Decoder mode selection

Open the Sound-2 menu: Press **MENU** button. Select **Sound-2** in the Main menu using arrow buttons . Use the right-hand arrow button to move the green marker to the Sound-2 menu for the selected decoder mode.

The desired decoder mode (see diagram) can be selected by pressing the arrow buttons if the first line of the respective Sound-2 menu is marked green.

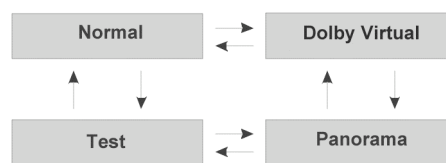

Normal television sound

Open the Sound-2 menu: Press **MENU** button. Select **Sound-2** in the Main menu using arrow buttons . Use right-hand arrow button to move the green marker to the Sound-2 menu of the decoder mode selected.

Select **Normal** for decoder mode by pressing the relevant arrow buttons .

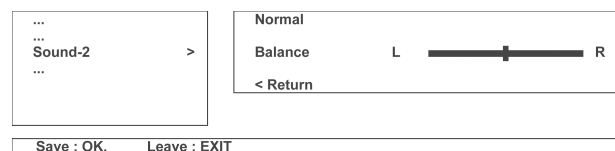

The broadcast television sound remains unaltered in this decoder mode.

Use arrow buttons to select the individual menu items. Use arrow buttons to modify the relevant settings or data.

The volume of the right and left speaker can be changed under **Balance** to achieve optimised stereo playback.

Press the **OK** button to store the settings. Press the **EXIT** button to quit the menu.

En

Dolby Virtual Surround Sound and Panorama

Open the Sound-2 menu: Press info button **MENU**. Select **Sound-2** in the Main menu using arrow buttons **▲** / **▼**. Use the right-hand arrow button **▶** to move the green marker to the Sound-2 menu for the selected decoder mode.

Select **Dolby Virtual** for decoder mode by pressing the relevant arrow buttons **◀** / **▶**.

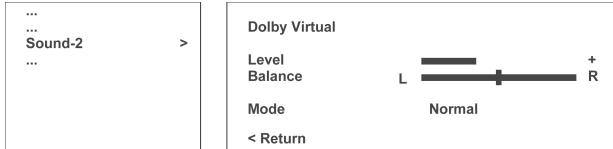

Save : OK. Leave : EXIT

or select the decoder mode **Panorama**.

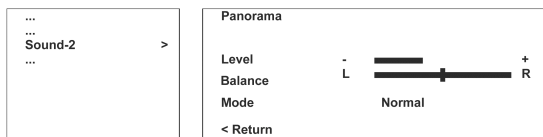

Save : OK. Leave : EXIT

Use arrow buttons **▲** / **▼** to select the individual menu items. Use arrow buttons **◀** / **▶** to modify the relevant settings or data.

Adjust the intensity of the surround signal under **Level**.

The volume of the right and left speaker can be changed under **Balance** to achieve optimised stereo playback.

Mode (Wide/Normal) creates the effect of acoustic base dispersion. This gives the impression that the speakers have been moved further apart.

Press the **OK** button to store the settings. Press the **EXIT** button to quit the menu.



Note:

In order to achieve an improvement in the 3-D sound when playing normal stereo sound, the decoder mode – **Panorama** – must be selected.

When playing back Dolby Pro Logic Surround sound, the decoder mode – **Dolby Virtual** – produces a 3-D sound similar to that of a home theatre system.

Volume level adjustment for Dolby Virtual Surround Sound and Panorama:

In order to give the sound the desired 3-D characteristics, the volume of both speakers and the intensity of the surround signal should be tuned as precisely as possible to match the position of the listener (e.g. sofa). This is called "noise focusing".

To adjust the level, select the decoder mode **Test**.

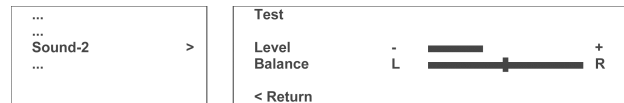

Save : OK. Leave : EXIT

When the arrow buttons **▲** / **▼** are pressed, the test signal generator sends the noise signal (tech.: "pink noise") alternately (for approx. 3-5 seconds per pulse) as a surround signal and to the individual speakers.

Adjust the intensity of the surround signal under **Level**. Under **Balance**, arrow buttons **◀** / **▶** can be used to adjust the volume of the relevant loudspeaker. The noise signal must sound equally loud on both channels from the listener's position.



Note:

Once saved, the basic setting only needs to be adjusted when the position of the listener or the TV setup changes.

Press the **OK** button to store the settings. Now select the desired decoder mode.

Special functions

Fade-in display window

The status line with channel position, channel names, sound mode and time is displayed by pressing the **INFO** button.



Otherwise the display will fade out automatically after approx. 5 seconds.

The time display only functions when a transmitter offers teletext.

The function buttons ...

Different functions can be assigned to buttons **F1**, **F2**, **F3** or **F4**.

1. Open the Pref. menu: Press **MENU** button.
2. Select **Pref.** in the Main menu using arrow buttons **▲/▼**.
3. Press the arrow key **▶** to move the green marker to the Pref. menu.
4. Select either **F1**, **F2**, **F3** or **F4** using arrow buttons **▲/▼**.

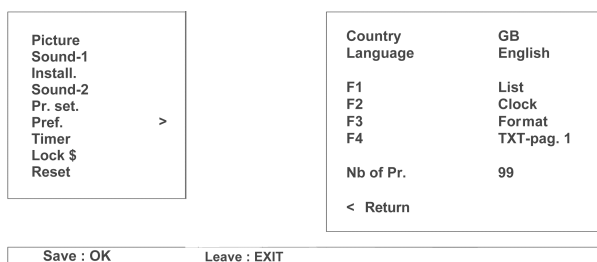

5. Use arrow buttons **◀/▶** to set the desired function.
6. Press the **OK** button to store the settings.
7. Press the **EXIT** button to quit the menu.
8. In normal TV mode, pressing the corresponding keys **F1**, **F2**, **F3** or **F4** activates the defined function.

List

1. The channel list appears on the screen.
2. A channel can be selected by pressing arrow buttons **◀/▶**.
3. To confirm the channel selected, press **OK** button.

Format

Switching picture format (see Adjusting the picture settings15). The first time the button is pressed, the OSD window for the current screen format appears on the screen. The picture format changes if the button is pressed again or at any other time. The window disappears approx. 5 seconds after the last procedural step is carried out.

TXT-page 1-4

Direct access to favourite stored teletext pages 1-4, see page 16.

Clock

1. The first time the button is pressed, the time is displayed.
2. The window disappears from the screen if the button is pressed again.

Timer

1. Open the Timer menu: Press **MENU** button.
2. Use arrow buttons **▲/▼** to select **Timer** in the Main menu.
3. Press arrow button **▶** to move the green marker to the Timer menu.

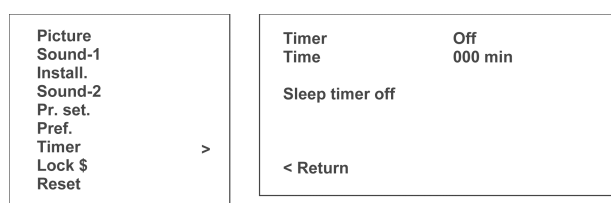

Use 0-9 keys. Leave: EXIT

4. Use arrow buttons **▲/▼** to select the individual menu items.
5. Use arrow buttons **◀/▶** to modify the relevant settings or data.

Setting the timer:

1. Under **Time**, enter the hours and minutes for the switch-off time using arrow buttons **◀/▶**.
2. Activate the **Timer** by setting it to **On**.

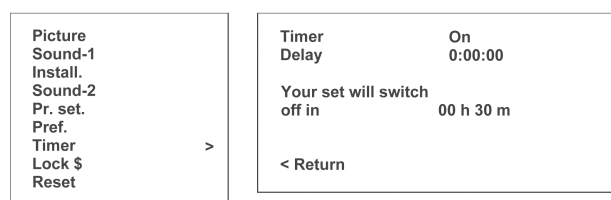

Set delay using 0-9 keys. Leave : EXIT

3. Press the **EXIT** button to quit the menu. The set automatically switches to standby mode after the specified time has elapsed.

Childproof lock

1. Open the Lock menu: Press **MENU** button.
2. Select **Lock** in the Main menu using arrow buttons **▲/▼**.
3. Press arrow button **▶** to move the green marker to the Lock menu.

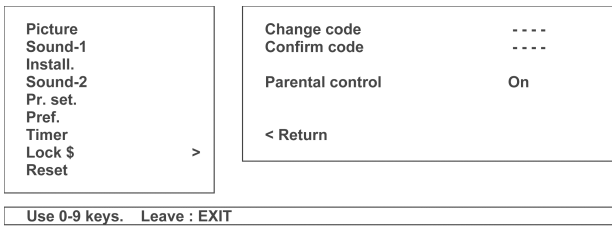

4. Use arrow buttons **▲/▼** to select the individual menu items.
5. Use arrow buttons **◀/▶** to modify the relevant settings or data.

Entering or changing the security code:

1. Select **Change code** and enter a 4-digit code using numeric buttons (**0-9**). Enter the same number combination for **Confirm code**.
2. Press the **OK** button to store the settings.

As a precaution, you should note down your selected security code.

Security code: _ _ _ _

The safety code **0000** is preprogrammed ex works.

Activating the childproof lock:

1. First check whether **Off** appears in the **Parental control** line in the Lock menu. Quit the menu by pressing the **EXIT** button.
2. Press the **MENU** button three times to display the station list for blocking individual channels for child protection.

1	ARD	
2	ZDF	
3	BR	
4	ORF1	
5	ORF2	
6	RTL	
7	RTL2	
8	SUPERRTL	\$
9	TVE	
10	SAT1	\$
11	VOX	
12	N-TV	
13	PRO7	\$
14	SF1	

Save : OK. Leave : EXIT

3. To block an individual channel, select it and confirm each selection by pressing the **red** button (**On**). The blocked channels are indicated by the **\$** icon.
4. Conversely, the individual channels can be unblocked by pressing the **green** button (**Off**). The **\$** icon disappears.
5. Quit the menu by pressing the **EXIT** button.
6. Then open the Childproof lock menu. Select the **Parental control** line and set it to **On**.
7. Press the **OK** button to store the setting.
8. Quit the menu by pressing the **EXIT** button.

The childproof lock is only active for the channels marked with a dollar sign **\$**.

A message requesting code input appears on the screen if the Childproof lock menu is then selected. The Childproof lock menu appears only after the correct Code has been input using the numeric buttons (**0-9**).



Note:

The screen is blank if a blocked channel position is selected. The **Programme under Parental control** window appears.

The security code only has to be entered once. It can, however, be modified at any time when the childproof lock is not activated.

If the childproof lock is activated, access to the Install. menu, the Pr. set menu, the Pref. menu and the Reset menu is blocked.

The Scart sockets on the rear of the unit are also blocked if the childproof lock is activated.

If you forgot the security code, please consult the technical customer services department or ask your dealer.

PIC (Picture in computer)

While viewing a PC picture, you can insert a video picture.

The inserted picture can be from the antenna or from a Scart socket.

- Press **yellow** key on the remote control to display the PIP picture on upper-left corner of the screen.
- Pressing again **yellow** key increases the size of the PIP picture.
- Pressing a third time **yellow** key erases the PIP picture.
- While PIP picture is displayed, you can scroll through TV channels with **blue** key or through AV programmes with **green** key.
- You can also change the PIP position with **red** key.

Note : the PC resolution should be set to mode of 640x480 to ensure PIP works properly (see page 21).

Resetting to delivery status

Open the Reset menu:

1. Press **MENU** button.
2. Select **Reset** in the Main menu using arrow buttons **▲/▼**.
3. Press arrow button **▶** to move the green marker to the Reset menu.

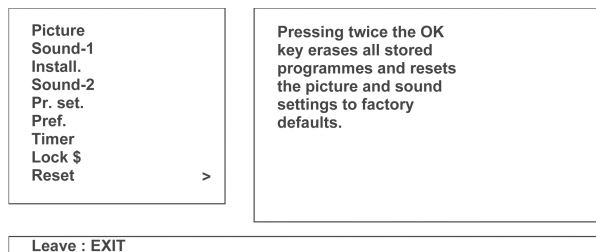

4. If you press **OK** button twice, the TV settings are restored to the factory settings, i.e. all channels, the personalised picture and sound settings, the dollar sign markings, the security code for the childproof lock and the timer settings are erased. The message **Please wait** appears during this process. The message **Reset completed** then appears on the screen.
5. Quit the menu by pressing the **EXIT** button.
6. Disconnect the unit from the mains by unplugging it.
7. Reconnect the unit to the mains. When the unit is switched on again using the mains switch (1) or the **⏻** button on the remote control, the initial start-up procedure appears on the screen (see page 13).



Note:

It is impossible to reset the TV to its original delivery status if the childproof lock is activated.

En

PC mode

Selecting inputs

A PC can be connected to the device via VGA socket (B), or a PC or another digital signal source can be connected via DVI socket (C) (see section Connecting auxiliary equipment on page 25).

1. The VGA input is selected via a selection menu. This appears on the screen if you press the **AV** button.
2. Select PC or DVI by pressing the arrow buttons **▲/▼**.
3. Press the **OK** button to store the setting.

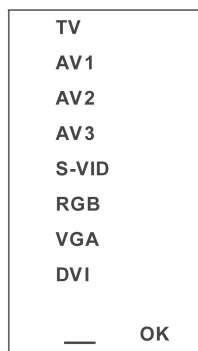

A window with the settings for the screen resolution (PC), horizontal deflection frequency (HFREQ) and vertical deflection frequency (VFREQ) appears for a few seconds.

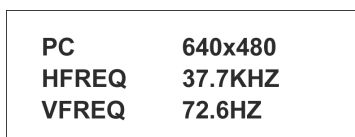

Setting the language and adjusting screen settings

1. Open the Picture menu: Press **MENU** button.
2. Use arrow buttons **▲/▼** to select the individual menu items.
3. Use arrow buttons **◀/▶** to modify the relevant data. Pressing **OK** button saves all the changes to the picture format.

Press the **EXIT** button to quit the menu.

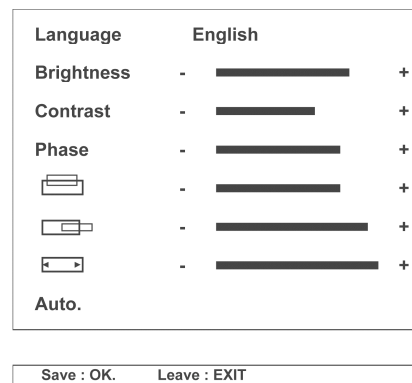

Note:

The television is compatible with Microsoft and Apple operating systems.

Teletext

Teletext signals...

are not always transmitted for the whole duration of the broadcasting time by all programmers.

A prerequisite for teletext is good reception. Fine tuning (see page 14) must be set accurately. If problems arise, however, the authorised dealer should check the antenna system.

TOP and FLOF Videotext are an improvement of the Videotext system: a menu line is transmitted in addition to the Videotext.

Not all teletext Programs support TOP or FLOF teletext. Navigation in teletext with TOP or fast-text differs from navigation in standard teletext.

Selecting teletext

Teletext mode:

Press the **blue** button. The contents menu is displayed on page 100.



If you switch to teletext mode directly upon switching on the television set or after changing channels, the contents menu will not appear immediately.

Select a desired page:

All pages can be selected using the numeric buttons (**0-9**). The three positions of the total page number are entered one after the other.

Television mode:

To return to television mode, press **EXIT** button.

Page memory facility

This LCD TV has a comprehensive videotext memory facility, which means you can open most pages instantly.

After switching on the television or changing the channel, the videotext pages are only in the memory once the complete cycle of pages (depending on the television station) has been run through. This can take up to 75 seconds.

In the case of multiple pages, the memory storage time may take longer depending on the number of subpages in question, as these can only be transmitted one after the other by the television station.

Which pages are stored in the memory?

- Page 100; contents menu
- 4 favourite pages
- At least 5 previous pages (**red** button)
- At least 30 subsequent pages (**green** button)
- The first page of each of the next 4 chapters (**yellow** button)
- The first page of each of the next 3 topics (**blue** button)
- Approximately 10 subpages of the page currently displayed
- At least 4 "link" pages with FLOF text

The remaining memory is filled up with the following pages.

Favourite pages

Up to 4 favourite pages can be selected for each channel. These can be opened directly by pressing the function buttons assigned, **F1-F2-F3-F4**.

Selecting favourite pages:

While in normal viewing mode, open the Pr. set menu: Press the **MENU** button. Select **Pr. set** in the Main menu using arrow buttons **▲/▼**. Press the right-hand arrow button **▶** to move the green marker in the Pr. set menu.

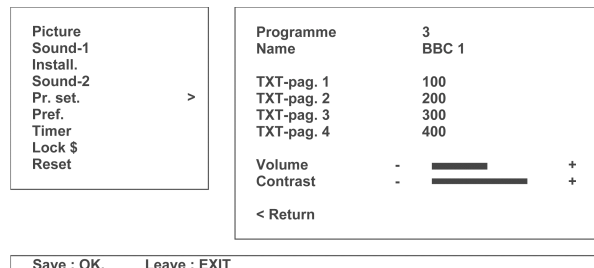

Use arrow buttons **▲/▼** to select the individual menu items.
Use arrow buttons **◀/▶** to modify the relevant data.

In the **Program** line, enter the number of the channel to which the favourite pages will be allocated. **Name** displays the relevant television station abbreviation automatically.

Enter the desired page numbers in the lines **TXT-page 1** to **TXT-page 4** as follows:

- Select one of the **TXT-page . . .** lines.
- Press arrow button **◀/▶**, the page number is displayed in red.
- Enter the desired 3-digit page number using numeric buttons (**0-9**). The page number returns to green.
- Select the next **TXT-page . . .** line, and so on.

Press the **OK** button to store the settings. Press the **EXIT** button to quit the menu.

If the relevant function buttons **F1-F2-F3-F4** are pressed during normal television operation, the teletext page assigned appears on the screen immediately. To exit teletext, press the **EXIT** button.

TOP / FLOF teletext

If the television detects TOP or FLOF Teletext, the TOP/FLOF information is displayed in the last line.

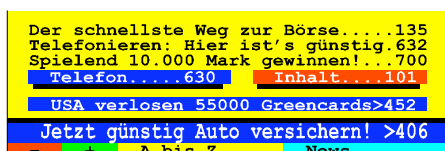

Pressing the coloured buttons selects these pages directly.

red button	(-) scroll down one page
green button	(+) scroll forward one page
yellow button	next section
blue button	next topic

If, for example, Current is displayed in the yellow column of the TOP/ FLOF line, you can call up this page by pressing the **yellow** button.

By pressing the **MENU** button once, the standard line -, +, P 100 and Mix is displayed in colour instead of the TOP/FLOF line.

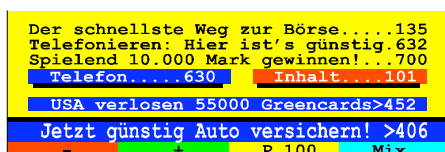

Pressing the respective colour button carries out the relevant function.

red button	(-) scroll down one page
green button	(+) scroll forward one page
yellow button	(P100) the table of contents on Teletext page 100 is automatically displayed.
blue button	(Mix) the television image is faded into the Teletext page. Press the button again to display the normal text page.



Note:

In standard text, if no TOP or FLOF is detected, the standard line is displayed instead of the TOP/FLOF line.

Multiple pages

Multiple pages run under a page number, however, consist of several subpages which are automatically activated one after the other. They may be displayed, for example, in the following way:

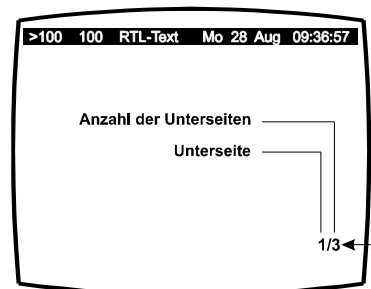

Opening subpages:

For a single displayed videotext page, approximately 4 subpages are stored in the memory. If these are already in the videotext memory, you can open them as follows:

- Press up arrow button **▲** to activate the subpage function.
- Open the desired subpage in ascending or descending order using **red** button or **green** button or
- enter the desired page directly as a 4-digit number using the numeric buttons (**0-9**).

Each subpage will appear on screen as selected. Press the down arrow button **▼** to deactivate the subpage function.

En

Operation

Other teletext functions

Press **MENU** button twice (with standard text press once) to display information lines for other functions; Zoom, Reveal, Stop and CS01-07.

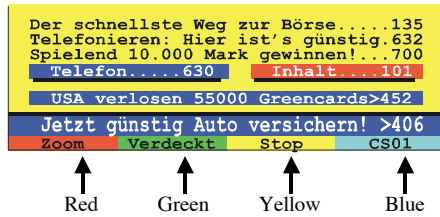

Pressing the respective colour button carries out the relevant function.

red button	Zoom
green button	Reveal
yellow button	Stop
blue button	CS01-CS07

Zoom	Press once: the top page half is displayed in double type size. Press twice: the bottom page half is displayed in double type size. Press three times: the full text page appears.
Reveal	to activated hidden information, such as results on tele colleague tasks, answers to quiz questions, solutions to TV quizzes, VPS lines etc. To fade out the information, press the button again.
Stop	to stop subpages, for further scrolling, press the button again.
CS01-CS07	Select the special character display for different language groups.

Current message

To display the current message in the television Program being shown, enter the number of the teletext page with the current content, e.g. last message using numeric buttons (**0** **9**). The current message appears in the active television picture.

Subtitle mode

Subtitles are faded into the image synchronously to a television program. They help deaf viewers or viewers with hearing deficiencies e.g. to understand Programs broadcast in foreign languages or provide them with translations for these Programs.

- In this case your television set must also be in Teletext operation.
- Use your remote control device to select the appropriate teletext page.
- To exit subtitle mode, press **EXIT** button.

Auxiliary equipment

Connecting auxiliary equipment



Note:
All units should be switched off before auxiliary equipment is connected. Only use the correct cables. Only switch the unit on once all connections are correctly made.



Note:
Only use high-quality Scart connection cables for maximum picture quality.

Connecting a video recorder:

The video recorder must be connected via the antenna (HF) ① if timer recordings are made using the video recorder or when another Program is to be watched during a recording. Connect the antenna/cable system plug with the antenna input on the video recorder, and the antenna output on the video recorder with the antenna socket for the TV set. In the Program menu, assign a free channel position to the output channel of the video recorder.

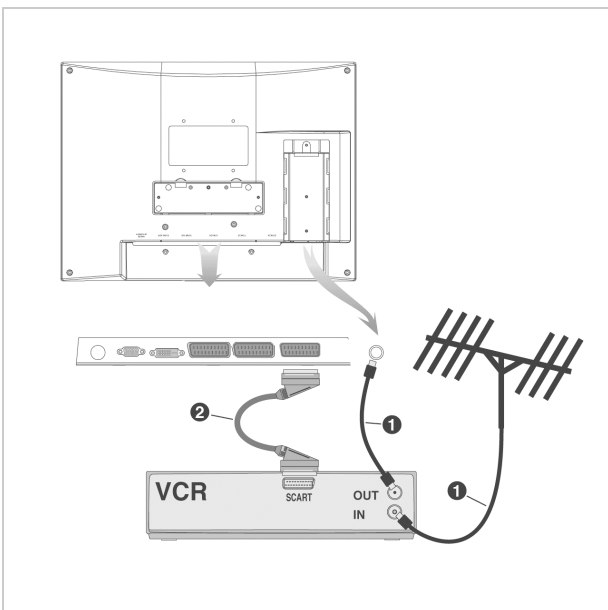

The television is fitted with up to three Scart sockets (see Specifications on page 3). An additional Scart connection ② provides optimum picture and sound quality. The required cable is available at your specialist dealer.

Connecting a satellite receiver or a Set-Top Box in combination with a video recorder:

Connect the connecting cable for the satellite or antenna/ cable system (①, ②) with the corresponding input of the satellite receiver or Set-Top Box. Loop the terrestrial signal (antenna/cable), if possible, as shown in the drawing ③.

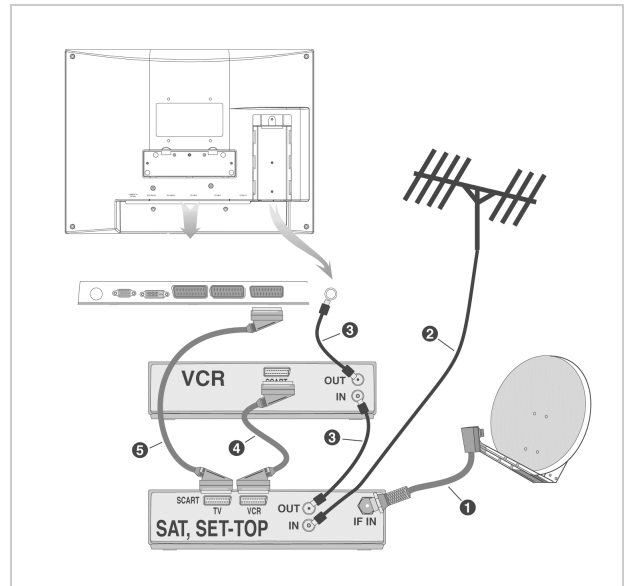

The Scart connection ④ provides optimised picture and sound quality for recordings from the satellite receiver. The connection ⑤ is recommended for optimised playback. The necessary fully configured Scart cable is available at your specialised dealers.

Connecting to external AV sources

AV signal

Connect a video recorder, for example, to Scart socket E (Scart 1). AV signals (picture and sound) can be recorded and reproduced via this socket.

Scart socket D (23LB020S4, 30LB020S4) or F (15LB020S4, 20LB020S4) are only used to reproduce the AV signal.

En

Auxiliary equipment

RGB signal

The RGB signal (red-green-blue colour signal), e.g. from a DVD player, digital SAT receiver or games console, can also be fed in using Scart socket E.

For RGB output the horizontal picture position can also be adjusted. This is carried out in the Picture menu.

Press the **red** button to open the Picture menu:



Save : OK. Leave : EXIT

Select the Picture position line using arrow buttons **▲ / ▼** and set them using arrow buttons **◀ / ▶**.

S-Video signal output

Connect the S-Video video recorder or S-Video camcorder to the Scart socket F for playback.

NTSC standard playback

In addition, playback of the NTSC standard 3.58 MHz and 4.43 MHz is possible via the Scart socket E.

Selecting sockets

The connection sockets can be selected using a selection menu.

This appears on the screen if you press the **AV** button.

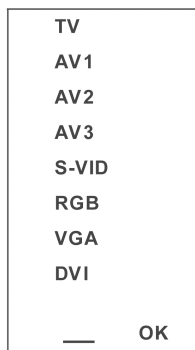

Use arrow buttons **▲ / ▼** to set the desired source. To activate, press the **OK** button. Press the **EXIT** button to quit the menu.

- Select AV 1, AV 2 or AV 3 to reproduce the AV signal:
AV 1: Scart socket E
AV 2: Scart socket F
AV 3: Scart socket D (only 23LB020S4 and 30LB020S4)
- Select RGB to reproduce the RGB signal (the playback device must be connected to Scart socket E).
- Select S-VHS to reproduce the S-VHS signal (the playback device must be connected to Scart socket F).

Select from the following possibilities for Source:

Tuner	The tuner signal is looped through and is output from Scart socket E.
Scart 1	The AV signal is input via Scart socket E, e.g. for video recorders, analogue satellite receivers, DVD players, etc.
AV 2	The AV signal is input via Scart socket F, e.g. for video recorders, analogue satellite receivers, DVD players, etc.
AV 3 (only 23LB020S4, 30LB020S4)	The AV signal is input via Scart socket D, e.g. for video recorders, analogue satellite receivers, DVD players, etc.
RGB	The RGB signal (red-green-blue) is fed in via blue Scart socket and has the best picture quality (most suitable for digital SAT receivers, DVD players and games consoles, etc.)
S-Vid.	The S-VHS signal is fed via the blue Scart socket, e.g. for S-VHS video recorders, etc.

Additional devices with switching voltage

If, e.g. the video recorder connected to one of the Scart sockets supplies a so-called switching voltage, the television automatically switches to the appropriate Scart socket (when the PLAY button on the video recorder is activated). The television set only reacts when the switching voltage is active. The channel position can be changed at any time, if necessary.

Copy function / recording via Scart sockets

If, for example, a tape is copied from one video recorder to another, recording can take place via Scart sockets D and E. Any Program can be viewed while being copied. Connect the playback video recorder to Scart socket D and the recording video recorder to Scart socket E.

1. Open the **Install.** menu for this. Press **MENU** button.
2. Select **Install.** in the Main menu using arrow buttons **▲/▼**.
3. Press the right-hand arrow button **▶** to move the green marker in the Install. menu.
4. Select **AV 1 output** out using arrow buttons **▲/▼**.

5. Use the arrow buttons **◀/▶** to set **AV 2** (15LB020S4, 20LB020S4) or **AV 3** (23LB020S4, 30LB020S4) as the input signal. The copying procedure can now be started.
6. Press the **OK** button to store the settings.
7. Press the **EXIT** button to quit the menu.



Note:

Pref. menu for Scart 1 out determines which signal is output at Scart socket E.
This setting is automatically valid for all channel positions.

Tuner	The tuner signal is looped through and is output from Scart socket E.
AV 2	The signal from the unit connected to Scart socket F is available as an output signal from Scart socket E.
AV 3 (only 23LB020S4, 30LB020S4)	The signal from the unit connected to Scart socket D is available as an output signal from Scart socket E.

En

Assigning the Scart sockets

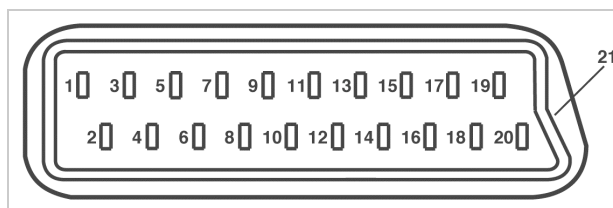

1	Audio out, right
2	Sound input right
3	Sound output left
4	Audio, earth
5	Blue input, ground
6	Audio in, left (mono)
7	Blue input
8	Switching voltage
9	Green input, ground
10	
11	Green input
12	
13	Red in, earth
14	Fast blanking, ground
15	Red in, S-VHS Chroma
16	Blanking signal, ground
17	Video output, ground
18	Video input, ground
19	Video output
20	Video in, S-VHS Luma
21	Shield

- AV signal 25
- Batteries 10
- Brightness 15
- Burn-in images 7
- Channel position settings 16
- Channel search 13
- Childproof lock 20
- Cleaning 6
- Clock 19
- Connection
 - External equipment 9
- Connection
 - Connection elements on the side of the unit 8
- Connections 8
 - Antenna / cable connection 9
 - Connecting auxiliary equipment 25
 - Connecting the headphones 9
 - Connecting to external AV sources 25
 - Connection elements on the rear of the unit 8
 - Mains connection 9
- Contrast 15
- Copy function / recording via Scart sockets 27
- Freeze-frame 7
- Initial startup procedure 12
 - Menu language 12
 - Standard sound 12
 - TV standard 12
- Instructions for waste disposal 6
- LCD TV 30LB020S4
 - Setup and installation 7
 - Speaker connection 7
- Lock code 20
- Maintenance 7
- Menu navigation 12
- NTSC standard 26
- Operating elements 10
 - Front of TV 10
 - Remote control 10
- Operation 13
 - Channel selection 13
 - Sleep mode 13
 - Switching on/off 13
- PC mode 21
 - Selecting inputs 21
 - Setting the language and adjusting screen settings 21
- Picture and sound 15
 - Adjusting the picture settings 15
 - Adjusting tone settings 16
- Picture quality 7
- Place of installation 6
- Quick guide 4
 - Connecting to the mains power supply 4
 - Front of unit 4
 - Selecting channels 5
 - Selecting inputs 5
 - Selecting TV mode on the remote control 5
 - Sockets on the rear of the unit 4
 - Switching on the LCD TV 5
 - Switching the LCD TV to standby mode 5
 - Television reception via Scart socket (e.g. SAT or cable receiver) 5
 - Television reception via the antenna cable 5
- RGB signal 26
- Risk of burning-in 7
- Scope of delivery 7
- Setting channels 13
 - Deleting channels 15
 - Direct channel input 14
 - Fine tuning 14
 - Setting the transmitter automatically 14
 - Sorting channels 15
 - Unit configuration 13
- Setting up channel positions for external units 26
- Sleep mode 13
- Sockets 26
- Special functions 19
 - Childproof lock 20
 - Clock 19
 - Fade-in display window 19
 - Format 19
 - List 19
 - Resetting to delivery status 21
 - Teletext pages 19
 - The function buttons 19
 - Timer 19
- Standby 7
- S-VHS signal 26
- Teletext 22
- The Dolby Virtual Surround Sound Decoder 17
- The Panorama Sound decoder 17
- Timer 19
- Tone 15
- Transportation 6

Free Manuals Download Website

<http://myh66.com>

<http://usermanuals.us>

<http://www.somanuals.com>

<http://www.4manuals.cc>

<http://www.manual-lib.com>

<http://www.404manual.com>

<http://www.luxmanual.com>

<http://aubethermostatmanual.com>

Golf course search by state

<http://golfingnear.com>

Email search by domain

<http://emailbydomain.com>

Auto manuals search

<http://auto.somanuals.com>

TV manuals search

<http://tv.somanuals.com>