

M a n u e l  
d' u t i l i s a t i o n -  
B e d i e n u n g s -  
a n l e i t u n g -  
M a n u a l e d i  
u t i l i z a z i o n e -  
U s e r  
m a n u a l .  
M a n u a l d e  
u t i l i z a c i ó n -  
G e b r u i k s -  
a a n w i j z i n g -  
B r u k s a n -  
v i s n i n g -  
B e t j e n i n g s -  
v e j l e d n i n g -

# TELEFUNKEN

DF321E / DF421E

F o l h e t o d e  
u t i l i z a ç ã o -

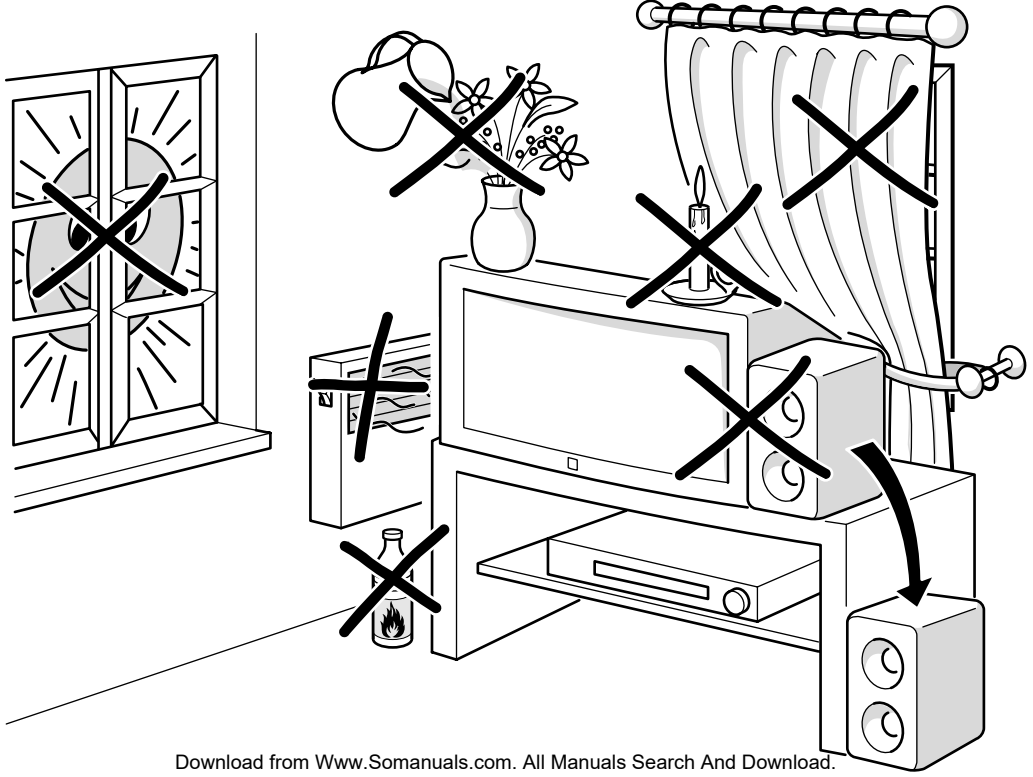
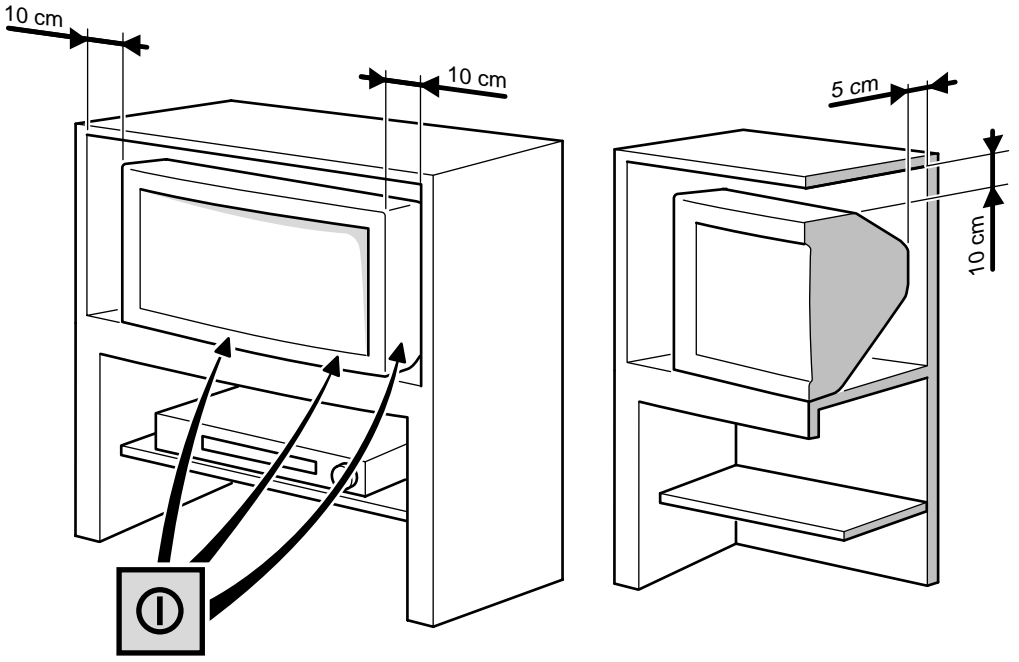

## About this manual

This document is common to several television models. Therefore, certain functions or settings may not apply to the model you have purchased

## About the switch

The position of the ON/OFF switch ① differs depending on the model. It may be located on the front or on the right-hand side of your set (see the drawing inside the cover page of your manual).

## About safety

**To ensure your own safety and safe operation of the equipment, observe the following instructions thoroughly.**

TV sets require sufficient ventilation to prevent their components from overheating, which will cause failure. Do not block the ventilation openings at the rear. If you place your TV set in a special piece of furniture, make sure there is enough space for unhindered air circulation. Do not place the TV set in the close vicinity of a heater.

The TV set has been designed for use in dry rooms. Should you use it, in exceptional circumstances in the open air (example: on the balcony, in the veranda or tent), you must absolutely protect it against moisture (dew, rain, splash water). Before switching on a cold TV set in a warm room, you should wait until any condensation in the screen has dried by itself.

Maximum ambient temperature: 35°C

Maximum humidity: 85%

By the end of your TV evening or when away from home for a longer period, we recommend that you turn off the TV set with the On/Off-switch.

Even when the On/Off-switch is in the Off-position, your TV set is not fully disconnected from the mains. To disconnect the set completely, the mains plug must be pulled out.

**The mains plug must be easily accessible.**

In the following cases, we recommend that you pull out the mains connector:

1. During a thunderstorm. In such a case, it is advisable that you also disconnect the TV set from the aerial socket.
2. When odour or smoke emanates from the set.

**Never attempt to open your TV set yourself.**

Further information:

The TV set shielding is sufficient to prevent X-radiation to the exterior.

Any operation performed by a non skilled person, change of high voltage or replacement of the picture tube by a model not complying with the manufacturer specification are likely to cause considerable increase in X-radiation. A TV set modified in such a way no longer complies with the manufacturers' specification and must not be used.

## About cleaning

The screen is to be cleaned with liquid glass cleaners.

- Never use abrasive products.
- Clean the cabinet with a soft cloth soaked with neutral cleaner. Do not use solvents, such as white spirit or alcohol-based cleaning products since they may damage your television.
- At regular intervals, clean the ventilation grids at the rear of the TV set.

## About degaussing

The terrestrial magnetic field may have an influence on your TV set. This influence is revealed by the coloured spots, which appear on the screen.

Should this be the case:

- Turn the equipment off by means of the On/Off-switch.
- Wait about one hour before switching the set on again.

This procedure performs automatic degaussing of the screen. Should there still be coloured spots on the screen, repeat the operation.

# Contents

GB

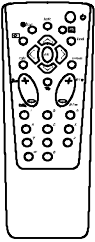

Using the remote control and fitting the batteries.

Page 4

How to call up a menu and how to select a function, a setting or an option.

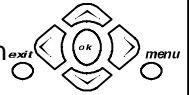

Page 5

## Installation

About this manual .....	1
About the switch .....	1
About safety .....	1
About cleaning .....	1
About degaussing .....	1
<b>Basic connections .....</b>	<b>3</b>
<b>Remote control .....</b>	<b>4</b>
<b>Navigation principles .....</b>	<b>5</b>
Calling up the Installation main menu ...	5
Calling up the Settings summary .....	5
Calling up a Menu .....	5
Navigating within the Menus .....	5
<b>Installing your television for the first time .....</b>	<b>6</b>
<b>Automatic installation .....</b>	<b>7</b>
<b>Programme organisation .....</b>	<b>8</b>
<b>Manual programming .....</b>	<b>9</b>
<b>Personal settings .....</b>	<b>10</b>
<b>Preferences .....</b>	<b>11</b>

## Instructions for Use

<b>Daily viewing .....</b>	<b>12</b>
Picture Adjustment .....	12
Sound Settings .....	12
Time .....	13
List of Channels .....	14
Selecting Programmes .....	15
Scrolling the Programmes .....	15
Audio-visual (AV) Programmes .....	15
Volume Control .....	15
Muting the Sound .....	15
Zoom (16/9 models only) .....	15
Displaying Information .....	15
Television Lock .....	15
Switching Off the Television .....	15
<b>Teletext .....</b>	<b>16</b>
Standard Functions .....	16
<b>Other Connections .....</b>	<b>17</b>
Other Possibilities .....	17
Connecting a HiFi or AV amplifier .....	17

# Basic connections

The mains plug (1) supplies power to the television. The television must only be plugged in to a 220-240 V - 50 Hz power supply. It must never be plugged in to a DC source. If the plug comes away from the lead, never attempt to plug it in: this could cause electrocution.

The aerial socket (2), located on the rear of the television, can be used to connect an external aerial or other appliance equipped with a modulator such as a VCR, satellite receiver, etc.

*If you connect an appliance to the aerial jack, you must give it a channel number. To do this, switch on the appliance, then use the television to find the modulator channel (see the appliance manual). Now give it a programme number and memorise it (see Manual Programming of channels). Then, when you wish to use the appliance, simply select its programme number on the television. This procedure is not required for VCR's not equipped with a modulator.*

The SCART socket AV1 (3), located on the rear of the television, is intended to connect a VCR or a camcorder (VHS, 8 mm), a Canal+ decoder, a video games console or RGB-signal emitting appliances.

The SCART socket AV2 (3), located on the rear of the television, is intended to connect a VCR or a camcorder (VHS, 8 mm, S-VHS or Hi-8).

*We strongly recommend the use of this type of connection, which gives a better picture quality. To use the peripheral appliance that you have connected, press the AV key on your remote control (press once to select AV1; twice to select AV2; three times for AV3: see "Other Connections"). This selection is automatic for some appliances. Pressing "play" on a VCR, or switching on a satellite receiver connected to AV1 or AV2 will automatically switch on your television.*

*When you stop the VCR, if you have not changed channels while watching the VCR, the television automatically switches back to the channel you were watching beforehand. If the television has been switched on from the VCR, it switches to standby when the VCR is switched off. The television automatically switches to 16/9 format if the connected appliance delivers the corresponding signal.*

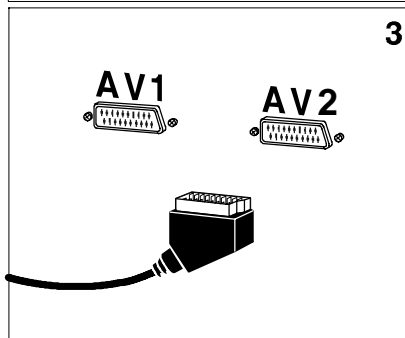
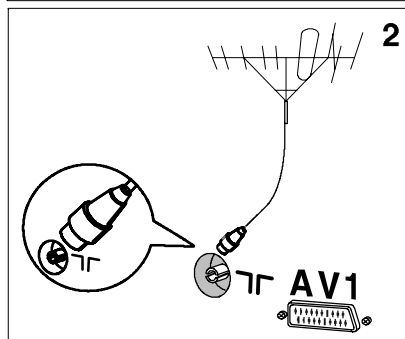
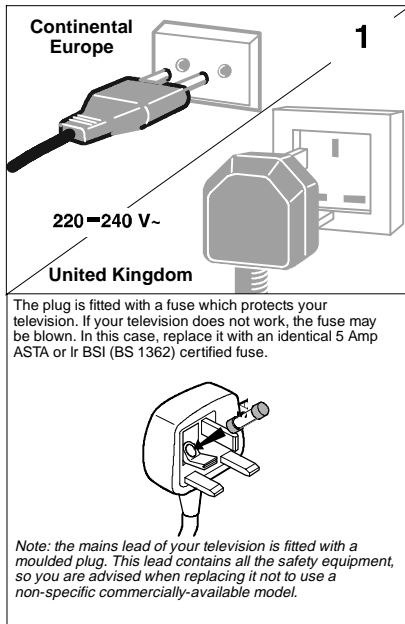

# Remote control

Display of channel, time, sound (yellow button) (and zoom for models with zoom)

This key is active only when using the Teletext (blue key)

Call up programme list (green button)

Standby

Reminder of picture preferences (red button)

Call up Teletext / Toptext / Fastext function (purple button)

Confirm an action or validate a menu option

Right/Left Selection within menus and Zoom Function (for models with this function)

To leave a menu or Teletext

Go to adjustment function MENU

Volume adjustment

Move Up/Down in menus

Sound mute

Change programme

Selecting appliances connected to the television (AV1, AV2 ...)

Go to programmes and enter numerical values in menus

For programme numbers higher than 10, press the 0 key on the remote control: "- -" appears on the screen. Now use the number keys on the remote control to enter first the tens digit then the units digit.

The red, green, yellow and blue keys are also used for the Teletext.

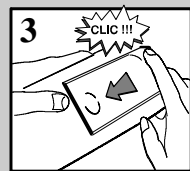
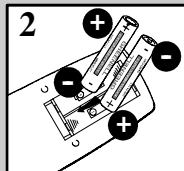
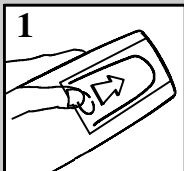

Please respect the environment! Before throwing any batteries away, consult your distributor who may be able to take them back for specific recycling.

# Navigation principles

## Calling up the Installation main menu

If there is no menu displayed on the screen, press and hold the **menu** key on the remote control. The settings **SUMMARY** is displayed first, followed by the **INSTALLATION MAIN MENU** which you can use to operate your television.

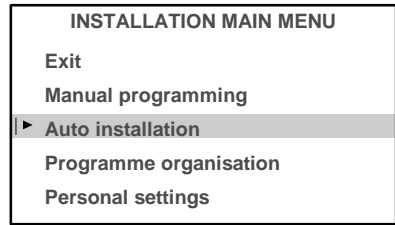

GB

## Calling up the Settings summary

Press and release the **menu** key on the remote control to display the list of menus available for using your television functions or adjusting your television



## Calling up a Menu

Select the menu you wish using the **Up/Down** keys. Press the **ok** key to validate..

## Navigating within the Menus

Use the **Up/Down** keys ① to select a line.

Use the **Left/Right** keys ② to:

- Increase or decrease a value:  
for example:  
Fine tuning ◀▶
- Select an option:  
for example: Reception ◀▶ Aerial  
Reception ◀▶ Cable
- Activate or deactivate an option:  
for example: Decoder  ⇌
- Access a sub-menu:  
for example: Picture preferences▶

You can use the **ok** ③ key to:

- Activate or deactivate an option:  
for example: Decoder  ⇌
- Access a sub-menu:  
for example: Picture preferences▶
- Validate an action:  
for example: Store on PR number

Use the **exit** ④ key to exit a menu.

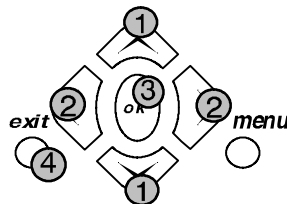
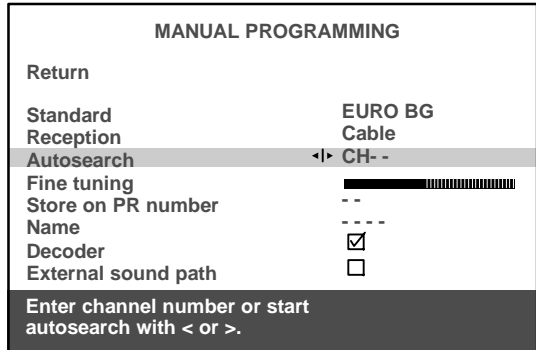





# Automatic installation

The **Automatic installation** function is useful if you have to go through the installation procedure again, such as when moving house. This function deletes all previously memorised programmes. To install a new channel, you should use the **Manual programming** function.

Before running **AUTO INSTALLATION**, check the **PERSONAL SETTINGS** menu to ensure that the country displayed is correct.



*Your television will only search for channels corresponding to the selected country, so see the **Manual programming** chapter to install any channels not found. For cable networks, if you have not found certain channels, select **Other** instead of a country name in the **PERSONAL SETTINGS** menu, then run automatic installation again.*

1. Press and hold the **menu** key on the remote control to display the **INSTALLATION MAIN MENU** (The **SUMMARY** appears first, followed by the **INSTALLATION MAIN MENU**).
2. Select the **Auto installation** line.
3. Validate using **ok**.

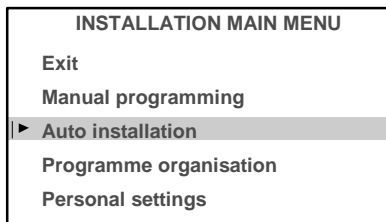

A message will inform you that **Automatic installation** has begun.

Wait for a few minutes.

A new message will inform you when **Automatic installation** is completed.

If you wish to check or reorganize your channel display, press the **ok** key and see the **Programme organisation** chapter.

If you do not wish to **reorganize your programmes**, you can exit this menu by pressing **exit**, then watch the programme of your choice. Choose the desired programme using the number keys (1, 2, 3, ...) and the **pr + / pr -** keys.

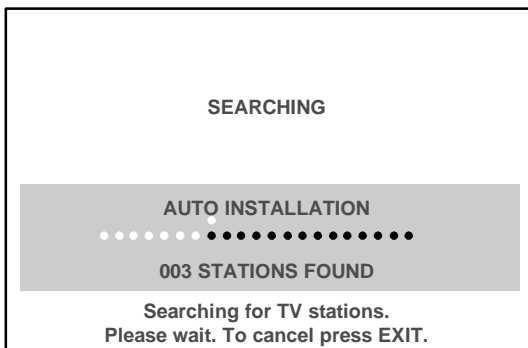

# Programme organisation

During automatic installation, your television will search for the channel name and assign it a programme number according to the selected country. You can use the **PROGRAMME ORGANISATION** menu to name any channel name not found, to change the order in which the channels are displayed, or to delete channels for which reception is too poor. Follow the messages at the bottom of the screen. For further details, read the information below.



If you wish to access the **PROGRAMME ORGANISATION**, menu thereafter, first press and hold the **menu** key on the remote control to display the **INSTALLATION MAIN MENU** (the **SUMMARY** is displayed first, followed by the **INSTALLATION MAIN MENU**) then select **Programme organisation** and validate using **ok**.

GB

INSTALLATION MAIN MENU	
Exit	
Manual programming	
Auto installation	
► Programme organisation	
Personal settings	

## - To delete a programme for which reception is too poor:

1. Select the line marked **Select program**.
2. Use the **pr + / pr -** or **Left/Right** keys to list your channels.
3. When you get to a channel you wish to delete, select the line marked **Delete program**.
4. Press **ok** to delete the programme.
5. Validate using **ok**.

## - To organize your channels to suit you:

1. Select the line marked **Select program**..
2. Use the **pr + / pr -** or **Left/Right** keys and the programmes logos to find the programme to which you wish to give the No.1. Its present number appears on the line marked **Select program**..
3. Select the line marked **Swap with PR**.
4. Enter **01**.
5. Press **ok**. The two programmes swap position and the desired programme becomes N°1.
6. Repeat the above procedure for the other channels.

## - To name your channels:

1. Select the line marked **Change pr. name**
2. Select the character you wish to modify using the **Left/Right** keys.
3. Use the **1** and **2** keys to display the letter you require.  
The name you have entered will be memorised when you move to another line or exit the menu.



If you wish to change the order in which your programmes are displayed or if you wish to name other programmes, repeat the procedures described above.

When you have finished organizing the programmes, exit the menu using **exit**.

PROGRAMME ORGANISATION		10	MTV
		11	FR2
		12	TF1
Return		13	EURO
		14	CH40
Select program.	< > 13	15	CC01
Swap with PR.	--	16	ARTE
Change pr. name	EURO	17	CART
Delete program.	13	18	----
		19	ARD

Select programme number using **PR-/PR+** or **</>** or **0** to **9** keys.

Select the line marked **Return** to return to the previous menu.

# Manual programming

The manual installation function is useful if some programmes have not been installed even after AUTOMATIC INSTALLATION.

1. Press and hold **menu**, the **SUMMARY** is displayed first, followed by the **INSTALLATION MAIN MENU**.
2. Select the line marked **Manual programming**.
3. Display the menu using **ok**.
4. Now continue by following the messages at the bottom of the screen. For further details, read the information below.

## Standard :

Select the standard using **Left/Right** keys that corresponds to your country from the list of standards.

*The number of standards proposed will differ from one model to another.*

<b>France</b>	for France and Luxemburg
<b>DKK'</b>	eg. for Eastern Europe and the Middle-East
<b>I</b>	for the United Kingdom and Ireland
<b>Euro BG</b>	for Western Europe

## Reception :

Your television can pick up channels either via an aerial (RF channels) or via a cable network. Certain cable networks use the same frequencies as the RF channels. If this is the case, you must select **Aerial** instead of **Cable**.

## Autosearch :

Enter the programme number if you know it. If not, search using the **Left/Right** keys. Your television will stop at the first channel it tunes into. If you wish to memorize it, go to the line marked **Store on PR number**. If not, resume the search using the **Left/Right** keys.

## Fine tuning :

You can use this to improve the picture if the transmitter frequency is out of adjustment. Use the **Left/Right** keys to obtain the best possible picture and sound.

## Store on PR number :

Enter the programme number you wish to give the channel (e.g.: 01 for BBC1). Memorise using **ok**.

## Name :

If the station has been identified by the transmitter, its name will be inscribed automatically. You can change the proposed name or enter it if it has not already been identified. Select the character you wish to modify using the **Left/Right** keys. Use the **1** or **2** keys to display the character you desire.

## Decoder :

Use the **Left/Right** keys to tick the box if the channel is coded and if a decoder is connected to the AV1 jack.

## External sound path :

Switch on your decoder. If the sound is coded or if you have no sound, activate or deactivate the box as required using the **Left/Right** keys.



*Once you have made all the adjustments you wish to a programme, go to **Store on PR number** and press **ok** to memorise these. Then move on to the next channel.*

Once you have completed your Manual Programming, exit the menu using **exit**.

INSTALLATION MAIN MENU	
Exit	
▶ Manual programming	
Auto installation	
Programme organisation	
Personal settings	

MANUAL PROGRAMMING	
Return	
Standard	EURO BG
Reception	Cable
Autosearch	◀▶ CH - -
Fine tuning	██
Store on PR number	--
Name	----
Decoder	<input checked="" type="checkbox"/>
External sound path	<input type="checkbox"/>
Enter channel number or start autosearch with < or >.	

Select the line marked **Return** to return to the previous

# Personal settings

1. Press and hold the **menu** key: the **SUMMARY** is displayed first, followed by the **INSTALLATION MAIN MENU**.
2. Select the line marked **Personal settings**.
3. Display the menu using **ok**.
4. Continue by following the messages at the bottom of the screen.

For further details, read the information below.

INSTALLATION MAIN MENU	
Exit	
Manual programming	
Auto installation	
Programme organisation	
▶ Personal settings	

## Menu language :

Select the language in which the menus are to be displayed.

## Country :

Indicate the country in which you are if you wish to rerun **Automatic Programming**.

*For cable networks, if certain channels have not been found, select **Other** instead of the country name before running automatic installation again.*

*You may find that the characters of certain teletext languages are inaccessible for the selected country.*



## Auto volume level :

This is a **sound control** function which aims to equalise the volume level between different channels, and between different programmes on the same channel.

Activate or deactivate the auto volume level as required.



*On models equipped with Virtual Dolby Surround, this function remains inactive if Dolby Virtual has been selected in the **SOUND** menu (see **Volume Control**).*

## AV1, AV2, AV3 name :

Use these to give a name to each of your audio-visual programmes. Select the character you wish to modify using the **Left/Right** keys. Use the **1** or **2** keys to display the desired character.

## Prog. to be used for reference time :

To display the time using the **info** key or to use the alarm function, the television clock must be set to the correct time. Select the line marked **Prog. to be used for reference time** and select a channel which broadcasts teletext. The time is set automatically and is displayed after the channel number.

Exit the menu using **exit**.

PERSONAL SETTINGS		
Return		
Menu language	English	
Country	UK	
Auto volume level	<input checked="" type="checkbox"/>	
AV1 name	VCR	
AV2 name	---	
AV3 name	CAMC	
Prog. to be used for reference time	< > 06	13:15
Select a station from which you want to get the reference time.		

Select the line marked **Return** to return to the previous menu.



## Picture Adjustment

Display the **SUMMARY** using the **menu** key on the remote control. Select **Picture**. Validate using **OK**. The **PICTURE** menu is displayed.

 *Select and set the proposed options. Use the information below to help you.*

### Brightness, Colour, Contrast, Sharpness:

Select each of these lines one after the other and set as required.

### Contrast expand :

Select this line then choose the desired Contrast expand setting (High or Low).

### Tone :

Select this line then choose the desired colour tone (Warm, Neutral or Cold).

Exit the menu using **exit**.

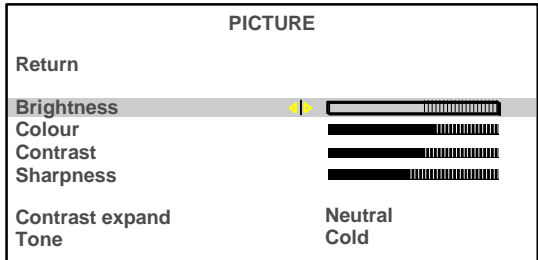

Select the line marked **Return** to return to the previous menu.

## Sound Settings

Display the **SUMMARY** using the **menu** key on the remote control. Select the line marked **Sound**. Validate using **OK**. The **SOUND** menu is displayed.

 *Select and set the proposed options. Use the information below to help you.*

### Sound type :

*The choices available to you depend on your television model and the broadcast. Stereo, Dual or NICAM reception and the corresponding choices are only available on Stereo or NICAM Stereo televisions.*

Select this line, then select the type of sound you desire.

### Sound mode :

Select this line, then choose the desired mode using the **Left/Right** keys.

*The choices available to you depend on your television model and the type of sound. Magic and Dolby Virtual modes are only available in stereo on TV's equipped with Virtual Dolby Surround.*

 *Stereo wide is only available on Stereo or Nicam televisions not equipped with Virtual Dolby Surround.*

### Balance L/R :

Select this line, then balance the sound between the Left and Right loudspeakers.

### Treble, Bass :

Select each of these lines and adjust to suit you.

### Surround effect :

 *This line appears only if you have selected Dolby Virtual on the Sound mode line.*

Select this line and adjust the surround effect to suit you.

Exit the menu using **exit**.

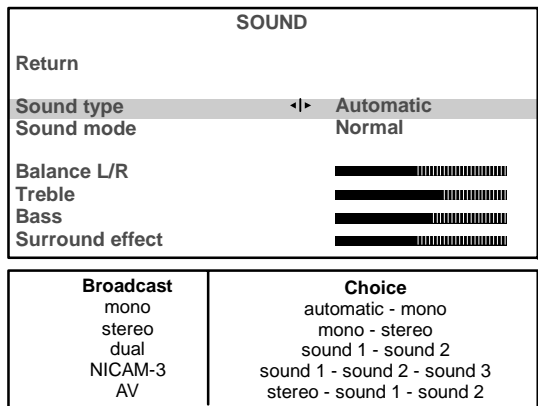

### Mode

#### Normal :

reproduces the original sound (mono or stereo).

#### Wide :

gives a stereo effect on mono sounds.

#### Stereo wide :

accentuates the stereo effect.

#### Magic :

accentuates the stereo effects and adds echo.

#### Dolby Virtual :

Virtual Dolby Surround.

*Virtual Surround Dolby is based on Dolby Pro Logic decoding for the reproduction of the Left, Right, Centre and Virtual Surround sound channels using two loudspeakers.*

*“Dolby”, “Pro Logic” and the double -D symbol are trademarks of the Dolby Laboratories Licensing Corporation.*

Manufactured under licence from Dolby Laboratories Licensing Corporation.

# Daily viewing

## Time



You can use this menu to switch your television on or off automatically at a set time.

Display the **SUMMARY** using the **menu** key on the remote control. Select the line marked **Time**. Validate using **ok**. The **TIME** menu is displayed.

### Sleep timer :

Use the **Left/Right** keys to choose how long you wish to view before the television switches off. The television will switch off automatically at the end of this period. To cancel, set to **00:00**.

*One minute before switching off, a message will inform you that the television is about to go off. If you wish to keep it on, press any key on the remote control or the local keyboard.*

*The television switches to Child lock mode after an automatic stop. It can only be switched on again from the remote control.*

### Current time :

The current time is given by the Teletext (see **PERSONAL SETTINGS** menu). You can also set the time manually using the number keys (0 to 9) on your remote control.

### Wake-up timer :



*If you wish to be woken up by your television on the channel of your choice, you must first set the television clock to the correct time (see above).*

Use the **Left/Right** keys to tick the box and display the **Wake-up timer** menu.



*The lines **Wake-up time**, **Programme number** and **Daily** only appear if you have ticked the box on the line marked **Wake-up timer**.*

### Wake-up time :

Use the number keys (0 to 9) on the remote control to set the time at which you wish to be woken.

### Programme number :

Select the programme you wish to be woken by.

### Daily :

Tick this box if you wish to be awakened at this time every day.

Exit the menu using **exit**.

Set the television to standby using the  key on the remote control. The red indicator light on the television flashes.

The television will come on automatically at the programmed time and will go off one hour later if you do not use the remote control.

TIME	
Return	
Sleep timer	< > 00 : 00
Current time	11 : 28
Wake-up timer	<input checked="" type="checkbox"/>
Wake-up time	07 : 07
Programme number	01 BBC1
Daily	<input type="checkbox"/>

Select the line marked **Return** to return to the previous menu.

## List of Channels



This list contains up to 10 pages. The number of pages depends on the number of programmes memorized. For each programme, the list indicates the station name or type and the programme number. The 3 AV programmes are listed on page 11.

GB

To display the list, press the **list** key on the remote control

or

Display the **SUMMARY** using the **menu** key on the remote control. Select the line marked **List**. Validate using **ok**.

The page displayed is the page containing the programme you are watching. It is identified in the list by the symbol **TV**.

To display the next page, press the **Right** key.

To display the previous page, press the **Left** key.

If you wish to watch one of the programmes on the page displayed: Enter the last digit of the programme number (e.g. for 25 simply enter 5) on the remote control. The list disappears and your programme is selected.

Or,

- Select the programme using the **Up/Down** keys.
- Validate using **ok**.
- Exit the menu using **exit**.

LIST	
Exit	
▶ 01	BBC 1
02	BBC 2
03	FR 3
04	CC19
05	ARTE <b>TV</b>
06	M6
07	CNN
08	PREM
09	EURO
Page -/+ ◀ / ▶	
Programme: 0 - 9	



## Selecting Programmes

For channels 1 to 9, press the number key corresponding to the desired channel on the remote control. For programme numbers higher than 10, press the **0** key on the remote control: "0-" appears on the screen. Now use the number keys on the remote control to enter first the tens digit then the units digit.



*If you press **0** while "0-" is already displayed, the display returns to **0-**, in which case you can only select programmes 1 to 9.*

## Scrolling the Programmes

You can scroll through the programmes using the **pr + / pr -** keys.

## Audio-visual (AV) Programmes

Press the **av** key to call the last audio-visual (AV) programme watched. Press repeatedly to scroll the audio-visual (AV) programmes on the screen.

## Volume Control

Use the volume +/- keys to increase or decrease the volume.

## Muting the Sound

Press the  key to mute the sound. Press again to restore the sound.

## Zoom

(16/9 models only)

*This function is useful for 4/3 or letterbox pictures (black bands at the top and bottom of the screen).*

Use the **Left/Right** keys to select the desired zoom position:

ZOOM 0: 4/3 picture (black bands at the sides).

FULL SCREEN: for a 4/3 picture that fills the screen.

ZOOM 1: for letterbox pictures.

## Displaying Information

Press the **info** key to display the following information on the screen: channel number and name, time, zoom, type of sound.

## Television Lock



*You can use this function to prevent anyone from switching on the television using the buttons on the television set.*

The buttons on the television set are locked in the following cases:

- If you switch off the set by pressing and holding the  key on the remote control for more than 3 seconds,
- After a programmed stop,
- If the television is set to standby when the alarm has been set.

*When the television is locked the red power will be light flashing.*

*The television can now only be operated from the remote control.*

*To release the lock, press any number key on the remote control.*

## Switching Off the Television

To switch off the television, press the Standby key on the remote control or press the ON/OFF switch on the television set.



Certain channels broadcast an electronic news page service with a range of different information services. The presentation and use of the Teletext differ from one country to another and from one programme to another (Teletext, Fastext or Toptext).

Press the **text** key to display the **Teletext Index** (page 100).

A message will inform you if the programme you are watching has no Teletext service.

### To call up a page:

Enter the 3 digits of the page number you wish to consult (for example, 150 or 170).

After a moment, the page appears.

Use the **Left/Right** keys to consult the next or the previous page.

## Standard Functions

### Rolling pages:

Some information is displayed over several sub-pages. It is scrolled on your screen as it is received.

To stop scrolling, select **STOP** using the **Up/Down** keys and validate using *ok*. Press *ok* again to continue scrolling.

### Masked text:

To reveal a hidden answer (for example in a quiz programme), select **???** using the **Up/Down** keys and validate using *ok*. Press *ok* again to hide the answers.

### Zoom :

Select **ZOOM** using the **Up/Down** keys then press the *ok* key once to magnify the top of the screen, twice to magnify the bottom of the screen (the page will scroll from top to bottom) and a third time to return to the normal display.

### Display:

You can superpose the Teletext page over the TV picture. To do this, select **MIX** using the **Up/Down** keys then validate by pressing the *ok* key. Press again *ok* to return to the normal display.

### Sub-code:

You can use this to access a sub-page directly.

Select "----" using the **Up/Down** keys. Then enter the four digits of the required sub-page number.



Certain programmes have **Alarm** pages that you can set to appear at the time you require. For example: for 15h30 enter **1530** as the sub-page number then press **exit**. You must of course leave the television on the programme which is to transmit the **Alarm** page.

### Index:

To call up the index page, select **100** using the **Up/Down** keys then validate using *ok*.

### Direct access:

You can use the yellow and blue keys to directly access the pages indicated in the bar at the bottom of the screen.

### Fastext functions:

If the Teletext you receive is Fastext, a sub-menu at the bottom of the screen appears which you can use to select from the 4 headings according to its colour.

To select a heading, press the key of the corresponding colour.

### Toptext functions:

If the Teletext you receive is TOPtext, the pages are arranged into headings and sub-headings by subject.

You can select the first page of a heading directly by pressing the blue key, or the first page of a sub-heading by pressing the yellow key.

### Other functions:

With certain Teletext channels, it is possible to have sub-titles overlaid on the screen for certain broadcasts as well as certain news flash updates.

The corresponding page number is indicated in the Teletext index.

Once you have found the page, the sub-title or the news flash will be overlaid onto the TV picture.

The navigation status bar disappears after a few seconds. To display it again, press the **text** key.

To exit Teletext, press **exit** or **text**.

# Other Connections

The CINCH Video and Audio sockets (1)\* are provided to connect a VHS or 8mm camcorder.

The S and CINCH Audio sockets (1)\* are provided to connect a S-VHS or Hi-8 camcorder.



*To use the appliance you have connected, press the **av** key several times until the AV3 programme is selected on the screen. When you switch off the connected appliance, the television will remain on the AV3 programme and you must use the numerical keys on the remote control to select a programme.*

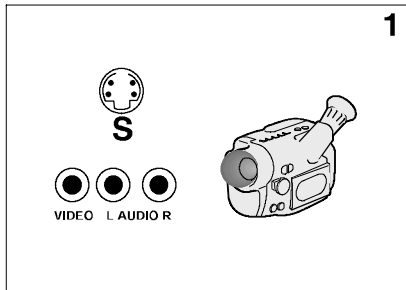

\* on models equipped with this function

The headphone socket (2)\* is provided to connect a headphone or earphones.



*Connecting headphones mute the sound from the television loudspeakers.*

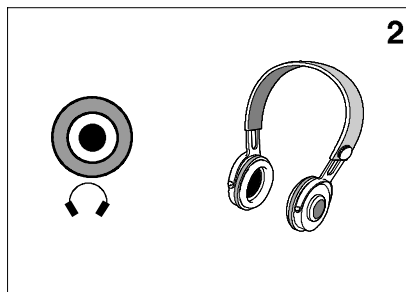



\* on models equipped with this function

## Other Possibilities

### Copying a cassette:

Plug the VCR **you wish to record to** into the SCART socket AV2.

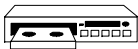
Plug the appliance **you wish to copy from** as follows: into the peripheral jack AV1 for a VCR; into the CINCH AV3 jacks for a camcorder (see table below).

PLAY		RECORD		CALL PROGRAMME
Appliance	SCART Socket	Appliance	SCART Socket	
 VCR	Peripheral AV1	VCR ou Camcorder	AV2	AV1
 Camcorder	Cinches or S-Video AV3	VCR ou Camcorder	AV2	AV3

### Connecting a HiFi or AV amplifier

If you wish to connect a HiFi or AV amplifier, plug it into the peripheral jack AV2 using a SCART-CINCH type lead.



THOMSON multimedia  
46/47 Quai A. Le Gallo 92648 Boulogne Cedex France  
RCS Nanterre B 322019464

**TELEFUNKEN**

06 - 98 - 253 534 70



## Free Manuals Download Website

<http://myh66.com>

<http://usermanuals.us>

<http://www.somanuals.com>

<http://www.4manuals.cc>

<http://www.manual-lib.com>

<http://www.404manual.com>

<http://www.luxmanual.com>

<http://aubethermostatmanual.com>

Golf course search by state

<http://golfingnear.com>

Email search by domain

<http://emailbydomain.com>

Auto manuals search

<http://auto.somanuals.com>

TV manuals search

<http://tv.somanuals.com>