

FERGUSON

T 5173 GF AND V 51 NB

COLOUR TELEVISION
WITH NICAM DIGITAL STEREO
SOUND AND FASTEXT

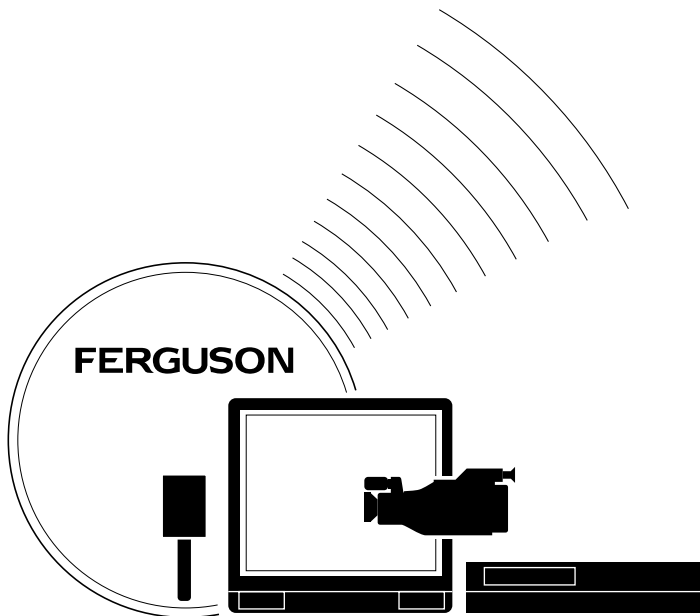

OPERATING INSTRUCTIONS

MAINS CONNECTION AND REMOTE BATTERIES



MAINS CONNECTION

The TV is suitable for use on a.c. mains supply, 220-240V, 50 Hz only. It must not be connected to d. c. mains.

NOTE : The mains lead of the TV is fitted with a moulded plug. If the mains sockets are not compatible or if for any reason the plug is removed please follow these directions :

The moulded plug cannot be rewired and if removed must be disposed of safely.

DO NOT under any circumstances plug the severed plug into any mains socket as this could result in electric shock.

IMPORTANT : If the plug is removed rewire new plug as follows :

The wires in the mains plug are coloured in accordance with the following code :

BLUE - NEUTRAL

BROWN - LIVE

As the colours of the wires in the mains lead of this apparatus may not correspond with the coloured markings identifying the terminals in your plug, proceed as follows :

BLUE wire to the terminal coded N (Neutral) or coloured black.

BROWN wire to the terminal coded L (Live) or coloured red.

DO NOT make any connection to the terminal in the plug which is marked by the letter E or by the safety earth symbol \perp or coloured green or green and yellow.

A fused plug must be fitted with a 5A fuse approved by ASTA or BSI to BS 1362 and fuse covers must always be securely replaced.

REMOTE BATTERIES

The remote control requires two batteries size AAA as supplied with the unit.

Unclip the cover at the rear and insert the batteries the correct way round as shown. The ends are usually marked + and -. Replace the batteries when the unit no longer operates at normal viewing distances.

For a clearer environment, please dispose of used batteries in the containers provided for this purpose.



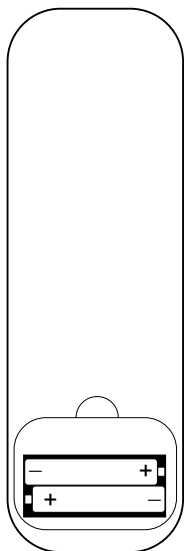

NOTE

When replacing batteries do not mix old and new - do not mix makes and types. Alkaline types are recommended for long life. Never risk damage to the remote control by extreme heat - do not leave close to a radiator or on a window ledge in direct sunshine.





THE REMOTE CONTROL

MAIN MENU to call up the menus :

-  **PREF.** ▶ Picture _____ page 11
-  **PREF.** ▶ Sound _____ 9
-  **---** : **---** ▶ Setting the clock _____ 13
-  **Program.** ▶ Manual channel setting _____ 15
-  **Organis.** ▶ Re-organizing programmes _____ 8

TIMER MENU to select functions :

-  ▶ Stand-By (Sleep timer) _____ page 13
-  ▶ Alarm _____ 14

The menus *Program.*, *Organis.* and *TIMER* can be locked. If you cannot display them, see page 19 on how to unlock them. The first line of the menus is automatically selected. To select another line, simply press the button again, to move down through the menus.

SOUND SELECTION

PICTURE SELECTION

PROGRAMME SELECTION

VOLUME LEVEL,
and adjustment or selection in menus.

INFORMATION DISPLAY,
(current channel, time, pre-sets)
and to leave menus.

SOUND MUTE

TELETEXT
and scroll up through the menus.

STAND-BY

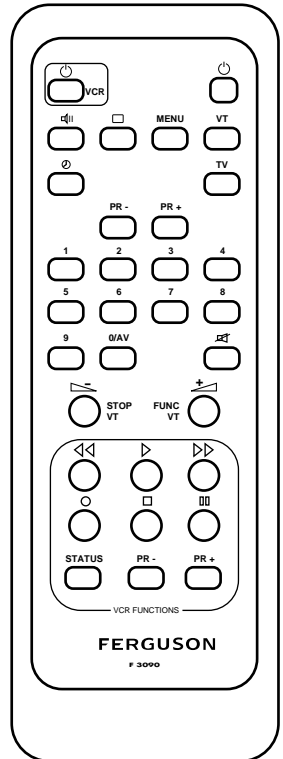

CONTENTS

	Page		Page
CONNECTIONS AND CONTROLS	4 - 5	MANUAL CHANNEL SETTING	15
TO TURN ON	5	CHILD LOCK	16
AUTOMATIC CHANNEL SETTING	6 - 7	CHANNEL NUMBER GUIDE	17 - 18
RE-ORGANIZING PROGRAMMES	8	TELETEXT AND FASTEXT	19
SOUND ADJUSTMENTS	9	CONNECTIONS	20
PICTURE ADJUSTMENTS	11	LOCKING MENU	21
DAY TO DAY OPERATION	12	REMOTE CONTROL	22
OTHER FUNCTIONS	13	SAFE USE OF EQUIPMENT	13
ALARM	14	PERITELEVISION (SCART) PIN CONNECTIONS ..	24

T 5173 GF

CONNECTIONS AND CONTROLS

At the back of the set.

Connect to A. C. main supply
220 - 240 V ~ 50 Hz.

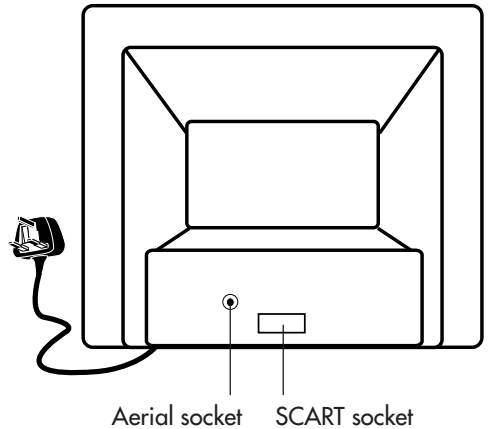

In front of the set.

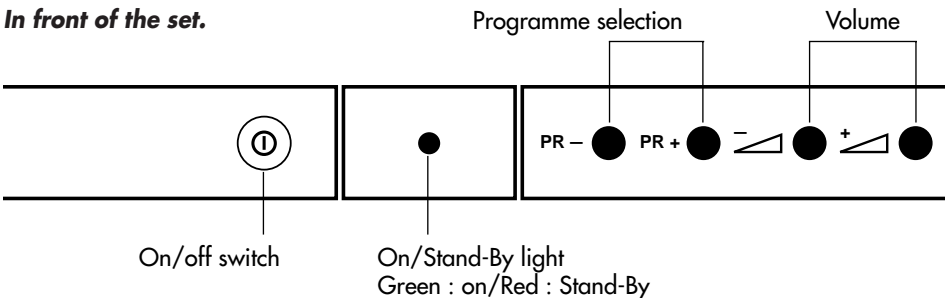

At the back of the set.

Connect to A. C. main supply
220 - 240 V ~ 50 Hz.

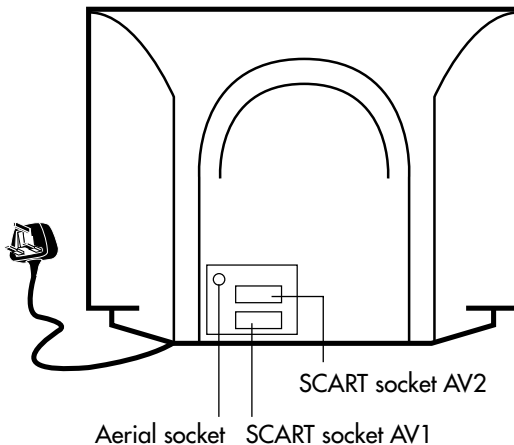

In front of the set.

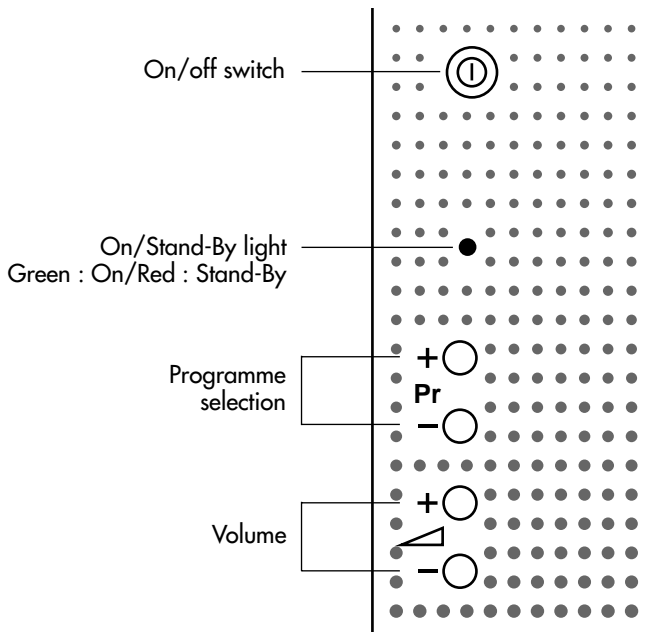

TO TURN ON

Press the on/off switch; the indicator light comes on.

Press button 1 on the remote control.

If your television set has not been tuned in, you may now begin tuning the channels.

Proceed to selecting the menu language in the *INSTALLATION MENU* page 6.

AUTOMATIC CHANNEL SETTING

This set is equipped with an automatic search system which will search and store all channels available in your region. To help identify the programmes, we suggest that you have to hand a TV guide or daily newspaper.

Ensure that the aerial lead is connected to the television and any VCR or SAT equipment that is connected via the antenna is turned on but do not switch on if also/only connected to a Scart/AV input. If your VCR is connected by RF cable and not by SCART and if you do not find the VCR output through Autoprogramming, then go to Manual Channel Setting.

1. INSTALLATION MENU

When the television set is turned on for the first time, the Installation menu appears automatically.

If this menu is not displayed, you can make it appear as follows :

- Switch the television to Stand-By.
- Switch off the television by pressing the on/off switch and wait for the light to go out.
- Switch the set back on, whilst keeping the PR/Pr – button on the television keypad pressed down until the INSTALLATION MENU appears.

Press repeatedly the button to select the menu language you require.

Press briefly, a new menu appears, automatic search begins. The cursor will move from left to right.

Please wait until the following menu appears.

INSTAL. MENU

English	press +
Deutsch	
Français	
Français (Belgique, Suisse)	
Italiano	
Español	

English	press +
---------	---------

AUTO-PROGRAMMING

Searching for stations	
UK	CCXX
Stations found : XX	

2. PROGRAMME ORGANIZER MENU

This menu is used for :

- allocating programme numbers and name the programmes auto tune has found (ie. BBC 1 in Prog. 1, etc...).
- storing the changes made in memory.
- erasing a programme.

PROGRAMME ORGANIZER

PR 01	CH22
To select a station	PR – / PR +
To give a prog. no.	+
To erase this station	-
When completed : press [TV]	

ERASING - STORING PROGRAMMES



Select the programme.



To erase :
keep pressed for some seconds until the station disappears.



To store :
press briefly and a new menu will appear.



Select the number that you want to give to the programme.

PROGRAMME ORGANIZER

PR 01 CH22

To select a station	PR - / PR +
To give a prog. no.	+
To erase this station	-
When completed : press [TV]	

PROGRAMME ORGANIZER

PR 01 CH22

Program No : --	- / +
Name : ----	
To store and continue	

PROGRAMME NAME

MENU



Press briefly to move to the **Name** line.



Press briefly. The first dash flashes.



Hold down (PR +) : the characters are displayed in ascending order.



Hold down (PR -) : the characters are displayed in descending order.



When the character you are looking for is displayed, move on to the next (+), or preceding dash (-).

To insert a space, use the empty character (between B and A).

Name : ---- PR - / PR + - / +

TO STORE IN MEMORY

MENU



Press briefly to select the **Store** line.



Press briefly to store your changes in memory, the + turns to OK.
The PROGRAMME ORGANIZER menu then reappears.

Repeat the above procedure to change other programmes.

To store and continue +

TV



Press briefly to clear the menu from the screen.

NEW CHANNELS

If a channel is not found or a new channel starts to broadcast in your region please refer to MANUAL CHANNEL SETTING.

NEW REGION

(If you move to another region, or you want to start again for any other

Start the automatic search again and reorganise the programmes. To do this, call up the INSTALLATION menu and proceed as described earlier (page 6).

All programmes and names previously stored are then erased.



Press briefly to clear the menu from the screen.

RE-ORGANIZING PROGRAMMES

If you subsequently wish to re-organize the order of your programmes please proceed as follows :

MENU



Press briefly to call up the main menu.

MENU



Press repeatedly until the **Organis.** line is selected.



Press briefly and the PROGRAMME ORGANIZER menu is displayed.

While the television is in any AV mode, (audio-visual), PROGRAMME ORGANIZER menu cannot be displayed.

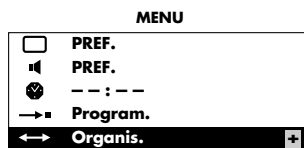

Select the programme.

To erase :

keep pressed for some seconds until the station disappears.

To store :

press briefly and a new menu will appear.

Select the number that you want to give to the programme.

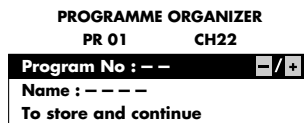
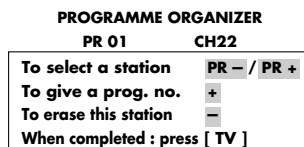

MENU



Press repeatedly to select the **Store** line.



Press briefly to store your changes in memory, the + turns to OK. The PROGRAMME ORGANIZER menu then reappears.

Repeat the above procedure to change other programmes.



Press briefly to clear the menu from the screen.

NICAM DIGITAL STEREO

NICAM (Near Instantaneous Companded Audio Multiplex) digital audio.

The digital signal broadcast together with the existing sound and pictures of terrestrial television are decoded by this receiver to enable high quality stereo sound to be reproduced with advantages similar to those of compact discs. i. e. extended dynamic range and channel separation with low noise and low distortion. These are considerable benefits compared with the current standard system. The digital channel separation will allow the Broadcasters to transmit dual languages as an alternative feature after the service is established.

You will be able to take full advantage of this exciting new facility. The increase in overall realism and ambience created by this new dimension in television sound will bring increased viewing enjoyment to all forms of programme material-to sport as well as the more obvious advantages to all forms of musical entertainment.

In the absence of NICAM signals or if the NICAM signal becomes extremely weak, the receiver will select the standard system automatically.

The standard signal can also be chosen by selecting the mono mode using the appropriate IMC on-screen graphics display. This is known as forced mono.

SOUND ADJUSTMENTS

MENU



Press briefly to call up the main menu.
The **PREF.** line is selected.

MENU



Press briefly to select the **PREF.** line.

MENU



Press briefly and the Sound menu appears.

The line is selected.

This varies depending on the sound type received.

NICAM STEREO or MONO SOUND

DUAL SOUND

NICAM 3 SOUND

AV SOUND

Select the desired sound for the loudspeakers.

MENU

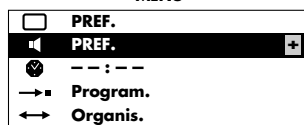

PREF.

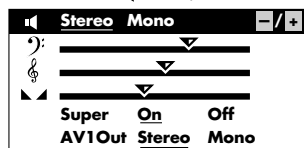

MENU



To adjust the tone

Select successively the lines bass and treble ,



then adjust bass and treble to the desired level.

*These personal adjustments can be recalled at a later stage (page 12, **PREF**)*

MENU



Select the **Balance** line.



To balance the sound level between the right and left sound channels.

MENU



Select the **Super** line.

Super On Off



Press briefly to choose:

Off : normal sound

On : stereo-effect sound for mono broadcasts,
wide stereo sound for stereo broadcasts.

The sound available on the AV1 socket should be matched to the type of VCR connected to AV1.

MENU



Select the **AV1 Out** line.

AV1 Out Stereo Mono



Press briefly to choose :

Stereo : stereo VCR

Mono : mono VCR

TV



Press briefly to remove the menu from the screen.

PICTURE ADJUSTMENTS

MENU



Press briefly to call up the main menu.

The **PREF.** line is selected



Press briefly and the picture menu appears.

The first line is selected.

MENU



Press the button repeatedly to select the function you want to adjust :



BRIGHTNESS



COLOUR



CONTRAST



SHARPNESS



TINT

The tint adjustment is active only in NTSC mode.

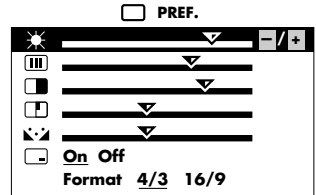
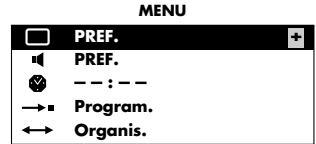

To carry out the adjustments.

These personal adjustments can be recalled at a later stage (page 12, **PREF.**).

PROGRAMME NUMBER DISPLAY

MENU



Select the line.



Press briefly to select :

On : constantly displayed

Off : only displayed briefly after programme change



S-VIDEO (This line appears only for an AV programme)

This is used to select S - VIDEO for use with devices (camcorders) which output this type of signal (S - VHS or HI - 8).

MENU



Select the line.



Press briefly to select :

On : S - VIDEO

Off : VIDEO



PICTURE FORMAT (only with special 16/9 signals)

This is used to select the format.

MENU



Select the **Format** line.



Press briefly to select the format : **4/3 or 16/9.**

Whenever a programme change is made, the set automatically switches over to the 4/3 picture format.



TV



Press briefly to clear the menu from the screen.

DAY TO DAY OPERATION

SWITCHING ON - SELECTING PROGRAMMES

Switch on the television set with the mains on/off switch if the indicator is off.
If it is on, select the desired programme :

For the programmes from 1 to 9 :

Press briefly the corresponding number.

For the programmes from 10 to 59 :

Press and hold on the decimal (tens) number.

Press the (units) number.

When the set is in Stand-By mode, you can also switch it on using buttons Pr -/+ or PR -/+ on the keyboard (if the television is not CHILD LOCKED).

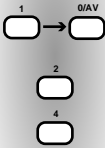

PICTURE ADJUSTMENTS

The television picture can be adapted to suit the current lighting conditions.
Press repeatedly to choose the setting you wish :



=
Dark



=
Dim



=
Bright



PREF

=
Personal adjustments

SOUND ADJUSTMENTS

The television sound can be adapted to suit the sound of programme being watched.
Press repeatedly to choose the option you wish :



=
Debates, news etc...



=
Musical programmes



=
Personal adjustments

SOUND MUTE - VOLUME ADJUSTMENT

Pressing once turns the sound off.

The sound returns if the button is pressed once more.

Set the volume as desired.

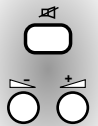

DISPLAY - PROGRAMME UP-DOWN

Displays the settings for the channel being watched: programme name and number - sound - time - Stand-By timer - alarm setting.

Some details will only be displayed if they have been entered.

Press repeatedly to run through the programmes stored in memory.



STAND-BY - AUTOMATIC SWITCH OFF

Press briefly. The Stand-By light turns red.

Note : The television will automatically switch to Stand-By after a few minutes if there is no signal on the channel being watched.



OTHER FUNCTIONS

SETTING THE CLOCK

MENU



Press briefly to call up the main menu.
The **PREF.** line is selected.

MENU



Press repeatedly to select the -- : -- line.

MENU



Press briefly. The Time Set menu is displayed.

MENU



Press briefly to select the **Program. No.** line.



Using the - / + keys, choose a programme which broadcasts teletext. The teletext time of this programme only will be used as a reference for the internal clock. *The internal clock sets itself automatically every time the television is turned on at the on/off switch on the reference programme, or select the time as follows :*

MENU



Press briefly to select the line.



Press - repeatedly to adjust the hours.



Press + repeatedly to adjust the minutes.

TV



Press briefly to clear the menu from the screen.

If you turn the television off at the on/off switch, the time setting is lost and the clock must be reset.

STAND-BY (SLEEP TIMER)



Press briefly. The menu shown on the right is displayed.

The line is selected.

Stand-By times of between 15 minutes and 4 hours can be set (in 15-minute steps).



Press repeatedly to adjust the hours (max. 4 hours).



Press repeatedly to adjust the minutes (from 0 to 45 minutes in 15-minute steps).



Press briefly to clear the menu from the screen.

The time left before Stand-By can be checked at any time:



Press briefly. The time left is displayed for a few seconds. 00 : 13

The television will be switched to Stand-By at the end of the timer interval.

The Stand-By light flashes to indicate that the CHILD LOCK function has been activated. The set can only be switched on again using the remote control, not by the keyboard.

You can cancel a sleep timer command :



Press briefly to display the menu.



Press repeatedly to go back to -- : --.



Press briefly to clear the menu from the screen.

MENU

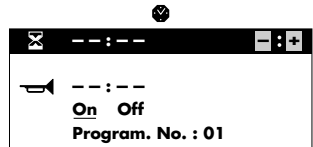
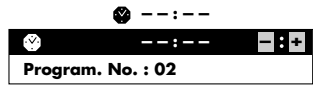
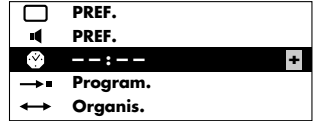

ALARM



This cannot be used if the clock is not set.

You can programme your television set to switch on automatically to a chosen programme at a chosen time. Firstly, make sure that the internal clock is set to the correct time. To do so :

Press briefly.

If the time display is -- : --, you cannot set the alarm. In this case, or if the time displayed is incorrect, you must first set the clock or. Refer to the SETTING THE CLOCK section.

If the time displayed is correct, the alarm can be programmed.

Press briefly. The menu shown on the right will appear.

Press briefly to select the line.

Press repeatedly to adjust the hours.

Press repeatedly to adjust the minutes.

Adjusting the alarm time automatically activates the alarm function :

On is selected.

Select the **Program. No.** line.

Choose the programme you want the set to switch on to.

If you wish to cancel the alarm function,

select the **On** line.

Select **Off** to deactivate the alarm function.

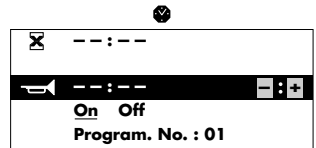

Press briefly to clear the menu from the screen.

Switch the television to Stand-By.

The Stand-By light flashes. The television will switch on to the selected channel at the time programmed. The symbol appears on the bottom right of the screen. It will automatically switch off after five minutes if no key is pressed on the remote control or on the television keypad.

If the set is switched on before the alarm function is activated, it will not switch to the programme selected for the alarm at the programmed time.

It is possible to programme both the automatic switching off (SLEEP TIMER) and switching on (ALARM). In this case, the automatic switching on time must be programmed to take place after the switching off time.

MANUAL CHANNEL SETTING

MENU



Press briefly to call up the main menu.

MENU



Press repeatedly to select the **→■ PROGRAM.** line.

While the television is in any AV mode, (audio-visual), PROGRAM. menu cannot be displayed.



Press briefly to display the **→■ PROGRAM.** menu. The first line is selected.

This line is inactive in the UK.

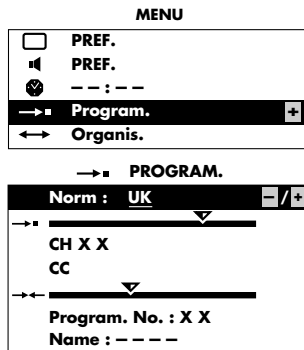

1. CHANNEL SEARCH

▶ *If you do not know the channel numbers*

Select the **→■** line.

Start the search by pressing :

- : backward channel search. **+** : Forward channel search.

The cursor will move and the channel numbers are displayed on the CH line when received via the aerial or on the CC line for cable network.

Once a station has been received, the picture appears on the screen. If the picture, corresponds to the station required, go to the **→←** line, otherwise continue the search.

▶ *If you already know the channel numbers*

Select the CH line for TV channels (aerial) or CC for cable networks.

Enter the channel number (it must have 2 digits).

e. g. : channel 6, enter 0 and then 6.

If your VCR is connected by RF cable and if you do not find the VCR output through Autoprogramming, set channel to 38 or 60 (see User Manual of your VCR) and use fine tune up and down until the VCR output is found.

Once found, then memorise the frequency against your chosen programme number (eg9).

2. FINE TUNING (OPTIONAL)

Fine tune can be used to remove interference if necessary.

Press briefly to select the **→←** line.

Press **+** or **-** to change the picture as necessary.

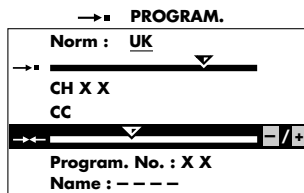

If you have a decoder to receive a scrambled channel, the TV set goes into AV when this channel is being received.

*In this case, disconnect the SCART socket from your decoder and call up the PROGRAM. menu. Select the **→←** line (Fine Tuning), reconnect the SCART socket and adjust the fine tuning if necessary.*

MENU



3. PROGRAMME NUMBER

Press briefly to select the **Program. No.** line.

Enter an unused programme number using the remote control.

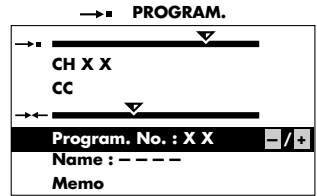

MENU



4. CHANNEL NAME

Press briefly to move to the **Name** line.

Press briefly. The first dash flashes.

Hold down (PR +) : the characters are displayed in ascending order.

Hold down (PR -) : the characters are displayed in descending order.

When the character you are looking for is displayed, move on to the next (+), or preceding dash (-).

To insert a space, use the empty character (between B and A).

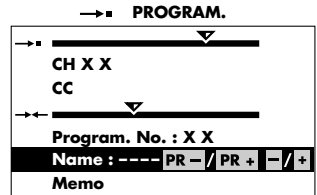

MENU



5. STORING IN MEMORY

Press briefly to select the **Memo** line.

Press briefly. The + turns to OK. The channel is stored in memory. One second later, the →■ line is selected again.

Search for and store all channels for the same standard.

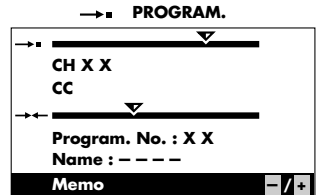

TV



Press briefly to remove the menu from the screen.

CHILD LOCK

You can prevent the use of your television set without the remote control.

The TV set is child locked :

- After the sleep timer function.
- After switching off the TV set by holding down the Stand-By button on the remote control for more than 4 seconds.

The CHILD LOCK function is indicated by the flashing of the Stand-By light. The television can only be switched back on using the remote control which cancels the child lock.

CHANNEL NUMBER GUIDE

Only the main transmitters are listed. There are in addition many relay stations, and full lists are available from the Broadcasting Authorities.

	BBC 1	BBC 2	ITV	CH4
London & South-East				
Bluebell Hill	40	46	43*	65*
Crystal Palace	26▼	33▼	23▼	30▼
Dover	50	56	66▼	53▼
Heathfield	49	52	64▼	67▼
Oxford	57▼	63▼	60▼	53▼
South-West				
Beacon Hill	57	63	60▼	53▼
Caradon Hill	22*	28*	25▼	32▼
Huntshaw Cross	55	62	59▼	65▼
Redruth	51	44	41▼	47▼
Stockland Hill	33	26	23▼	29▼
Channel Islands				
Fremont Point	51	44	41*	47▼
South				
Hannington	39▼	45▼	42▼	66▼
Midhurst	61	55	5*8	68*
Rowridge	31▼	24▼	27▼	21▼
West				
Mendip	58▼	64▼	61▼	54▼
East				
Sandy Heath	31▼	27▼	24▼	21▼
Sudbury	51▼	44▼	41▼	47▼
Tacolneston	62▼	55▼	59▼	65▼
Midlands				
Ridge Hill	22	28	25*	32*
Sutton Coldfield	46▼	40▼	43▼	50▼
The Wrekin	26	33	23	29
Waltham	58▼	64▼	61▼	54▼
North				
Belmont	22▼	28▼	25▼	32▼
Emley Moor	44▼	51▼	47▼	41▼
North-West				
Caldbeck	30*	34*	28▼	32▼
Winter Hill	55▼	62▼	59▼	65▼
North-East				
Bilsdale West Moor	33*	26*	29▼	23▼
Chatton	39	45	49*	42*
Pontop Pike	58▼	64▼	61▼	54▼
Scotland				
Angus	57	63	60*	53*
Black Hill	40▼	46▼	43▼	50▼
Sandale	22	-	-	-
Caldbeck	-	34	28▼	32▼
Craigkelly	31▼	27▼	24▼	21▼
Darvel	33	26	23▼	29▼
Durris	22▼	28▼	25▼	32▼
Eitshal	33	26	23	29
Keelylang Hill	40	46	43	50
Knock More	33	26	23*	29*
Rosemarkie	39	45	49*	42*
Rumster Forest	31	27	24*	21*
Selkirk	55	62	59▼	65▼

	BBC 1	BBC 2	ITV	CH4
Wales				
Blaenplwyf	31▼	27▼	24	21
Carmel	57	63	60*	53*
Llanddona	57▼	63▼	60*	53*
Moel-y-Parc	52	45	49*	42*
Presely	46	40	43*	50*
Wenvoe	44▼	51▼	41▼	47▼
Northern Ireland				
Brougher Mountain	22	28	25*	32*
Divis	31▼	27▼	24▼	21▼
Limavady	55	62	59*	65*

UK MAIN TRANSMITTERS



* Expected to commence NICAM transmissions before the end of 1995

▼ Already transmitting NICAM

CHANNEL NUMBER GUIDE (IRELAND)

In addition to the RTE main transmitters listed, there are many RTE transposers throughout the country. If your area is not covered by a main transmitter and you are not sure of the channel numbers of your local transmissions, your television dealer is the best person to advise you. He will also know whether you need a horizontal or vertical aerial to suit the transmissions.

REPUBLIC OF IRELAND	RTE 1	RTE 2	NORTHERN IRELAND	BBC 1	BBC 2	UTV	CH4
North-West							
Holywell Hill	23	26	Brougher Mountain	22	28	25	32
Truskmore	09 (I)	07 (G)	Divis	31	27	24	21
North-East			Limavady	55	62	59	65
Clermont Carn	52	56					
East							
Kippure	08 (H)	10 (J)					
Dublin & East			WALES	BBC WALES	BBC 2	HTV	SA4
Three Rock	29	33	Presely	46	40	43	50
West							
Maghera	02 (B)	08 (H)					
Central							
Cairn Hill	40	43					
South-West							
Mullaghanish	04 (D)	07 (G)					
South East							
Mount Leinster	06 (F)	09 (I)					

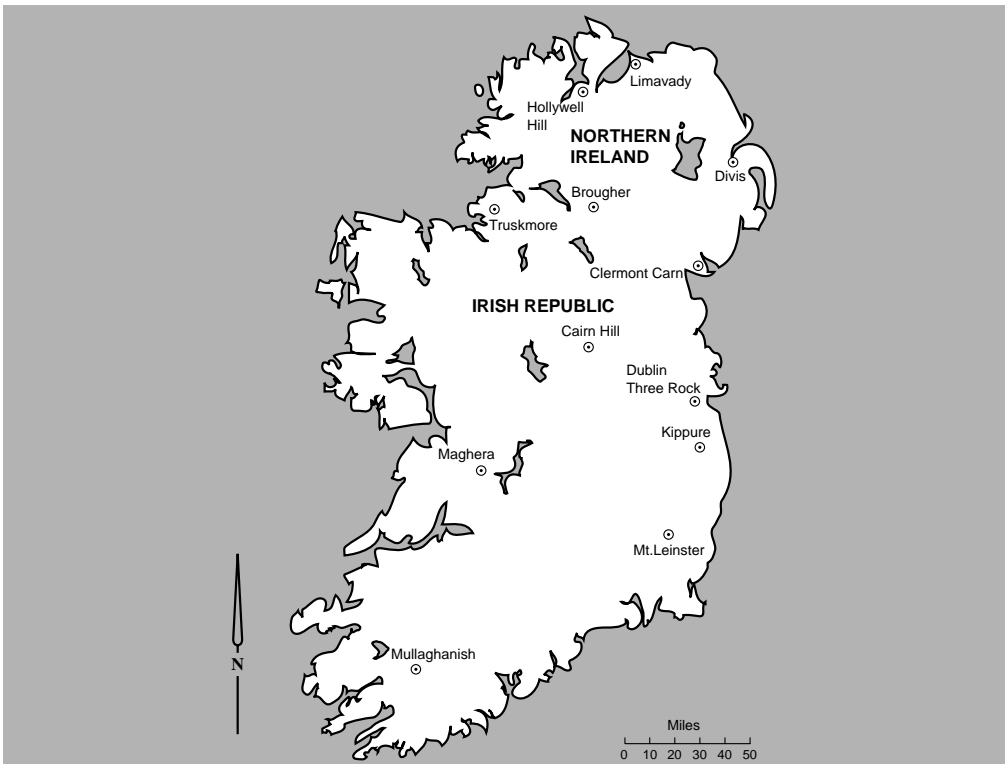

TELETEXT AND FASTTEXT

TEXT

Press the TEXT button to access teletext services, then use the number buttons to directly select any teletext page. All pages are three-digit numbers. For example, to select page 251, press 2 then 5 then 1.

If you enter a number which does not exist, (for example 800), the symbol > 800 < appears briefly on the top of the screen.

RED, GREEN, YELLOW, BLUE

These buttons have different functions according to which of two sub-menus is displayed in the four colours across the top of the screen.

FASTTEXT : Used with the first sub-menu as a method of fast page access to select, according to its colour, the title of one of four linked pages. Once selected four new titles will appear.

If you press the coloured buttons in rapid succession, it may be too quick for the system and a rolling green header line may appear until the page you want is transmitted.

TEXT CONTROL : Used with the second sub-menu for entering sub-page numbers (red) and controlling reveal (green), expand (yellow) and mix (blue) as explained below.

SUB-MENUS

Use the \pm button to toggle between the first and second sub-menus which are displayed as the bottom line of the teletext page.

MIX

With the second sub-menu displayed, press the BLUE button to superimpose a text page over a TV picture. To return to text only, press the BLUE button again.

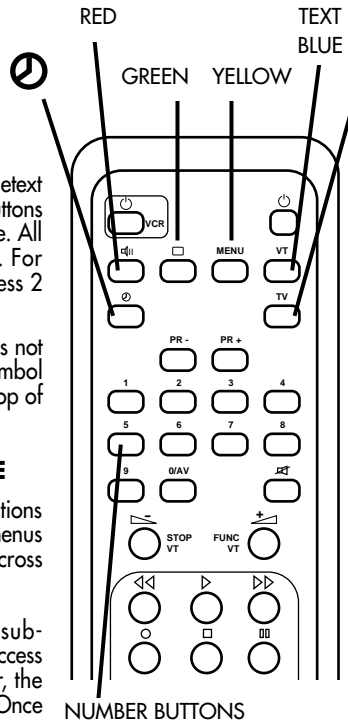

SUBTITLES AND NEWSFLASHES ON TV PICTURES

When the subtitle teletext page (normally 888) is selected, subtitles for the hard of hearing will be superimposed on the TV picture if the Broadcaster is providing this facility. The menu line and header line of the teletext page will disappear after about 10 seconds. To access further teletext pages, the blue TEXT button must be pressed again. Subtitles can be cancelled by pressing the TV button.

REVEAL

Some pages have concealed information which can be revealed by pressing the GREEN button while the second sub-menu is displayed. Press the GREEN button again to conceal it.

EXPAND

With the second sub-menu displayed, press the YELLOW button once to expand the top half of the page, press again to expand the bottom half and press again to restore the complete page.

HOLD (STOP)

Rolling sub-pages can be held on screen for as long as you wish by pressing the \triangleleft button. Press again to restore the rolling sequence.

INDEX (⊙)

This will access the index page of the section you are currently in. Pressing it again will take you to the main index (page 100).

SELECTING A SUB-PAGE/ROLLING PAGE

Select the required page, then with the second sub-menu displayed (use \pm button) press the RED button. Using the number buttons, first enter 00 and then two digits for the sub-page number required (for 1 to 9, enter 01 to 09). The sub-page you want will then be captured and held on screen.

RETURN TO TELEVISION VIEWING

Press the TV button.

CONNECTIONS

1. VIDEO RECORDER CONNECTION

Refer to your VCR manual.

VIA THE AERIAL SOCKET

Enables connection of the aerial and, if required, a video-recorder, (see note for the latter). To tune the channel reserved for your video-recorder, you must insert a cassette and start it playing. Next locate the corresponding channel on your television by carrying out "Manual channel setting" (p. 15). Store at any programme ending with a 9 (9, 19, 29, etc...). Each time you use the video-recorder, switch to the programme assigned to it.

VIA THE SCART SOCKET 1 (AV1)

This is used to connect :

- a PAY-TV (VIDEO) decoder
- a VHS, 8 mm, S-VHS or Hi-8 video recorder or camcorder (VIDEO)
- a PC or video games console (RGB)

VIA THE SCART SOCKET 2 (AV2) - (V 51 NB)

This is used to connect :

- a VHS or 8 mm (VIDEO), video recorder or camcorder

If you have two VCRs, the PAY-TV decoder must be connected to the VCR connected to the Euro-AV1 socket. If you have a satellite receiver, refer to the operating manual in order to find out the type of signal delivered. You can connect it to the PAY-TV socket of the second VCR if the latter is fitted with one.

2. CALLING THE AUDIOVISUAL PROGRAMMES

0/AV



Press once or twice to call AV1 or AV2 (V 51 NB).

In most cases, the television set changes automatically to AV1, when the VCR connected to the Euro-AV socket is in play back mode.

When the VCR is stopped and if you have not changed channel during play, the TV set returns to the station previously watched.

If the television has been switched on by the video recorder, it will be placed on standby when the video recorder is switched off.

The TV set changes automatically to 16/9 format if the unit connected supplies the control voltage.

4. COPYING VIDEO TAPES (V 51 NB)

Connect the playback VCR to the Euro-AV1 socket in playback mode. Connect the recording VCR to the Euro-AV2 socket in recording mode.

During the copying of the tape the picture on the screen is the picture of the played tape.

Note : S-VHS cannot be copied via the television.

LOCKING MENU

This menu is used for:

- locking the Program., Organis. and TIMER menus,
- limiting the volume.

MENU DISPLAY



Switch the television to Stand-By, then switch it off by pressing the on/off switch. To display the Locking menu, switch the set back on using the on/off switch whilst holding down the Stand-By button of the remote control for at least 6 seconds.

The menu to the right will appear :

The MAIN MENU line is selected.



LOCKING AND UNLOCKING THE PROGRAM. AND ORGANIS. MENUS



Press briefly to select ON. The Program. and Organis. menus are now no longer accessible.



Press briefly to select OFF. The Program. and Organis. menus are then accessible again :



LOCKING AND UNLOCKING THE TIMER MENU.



Press briefly to select the TIMER MENU line



Press briefly to select ON. The Timer menu is now no longer accessible.



Press briefly to select OFF. The TIMER menu is then accessible again.



VOLUME LIMITING



Press briefly to select the **MAX** line :



Set the maximum volume desired.
The volume will be limited to this level.



Press briefly to remove the menu from the screen.

REMOTE CONTROL

VIDEO CASSETTE RECORDER COMMANDS USING THE TV REMOTE CONTROL UNIT
Selected Ferguson Video recorders can be operated by direct infra-red remote control. This facility will be referred to in the appropriate video recorder operating instructions. Contact your Ferguson dealer for more details.

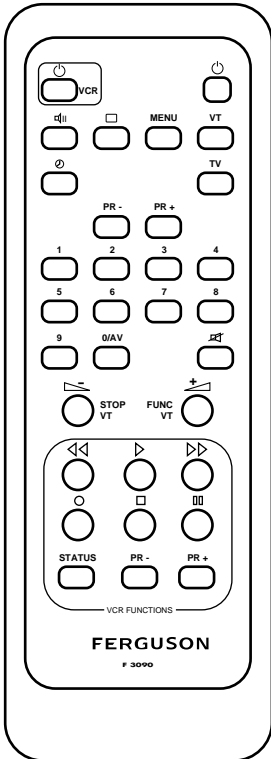

REWIND/SEARCH :

If this button is pressed and held in during playback, fast picture search (reverse) is obtained. Rewind will be obtained if the recorder is in Stop mode.



PLAY :

Press to start playback. When the Peritelevision socket is used see the section headed "Video recorder connection".



FAST FORWARD/SEARCH :

If this button is pressed and held in during playback, fast picture search (forwards) will be obtained. Fast forward will be obtained if the recorder is in Stop mode.



STOP : Press to stop tape movement.



PAUSE/STILL : Press during playback for pause.



RECORD : Press to start recording.



PR-/PR+ : VCR Programme selection



STATUS : To switch your VCR between TV and video modes, to display information on the screen or to leave the menus.



Press to switch on or on Stand-By.

SAFE USE OF EQUIPMENT

This equipment has been designed and manufactured to meet international safety standards but, like any electrical equipment, care must be taken if you are to obtain the best results and safety is to be assured.

Do read the Operating Instructions before you attempt to use the equipment.

Do ensure that all electrical connections (including the mains plug, extension leads and interconnections between pieces of equipment) are properly made and in accordance with the manufacturer's instructions. Switch off and withdraw the mains plug when making or changing connections.

Do consult your dealer if you are ever in doubt about the installation, operation or safety of your equipment.

Don't continue to operate the equipment if you are in any doubt about it working normally or if it is damaged in any way—switch off, withdraw the mains plug and consult your dealer.

Don't remove any fixed cover as this may expose dangerous voltages.

Don't obstruct the ventilation of the equipment, for example with curtains or soft furnishings. Overheating will cause damage and shorten the life of the equipment.

Don't listen to headphones at high volume, as such use can permanently damage your hearing.

Don't use makeshift stands and NEVER fix legs with wood screws—to ensure complete safety always fit the manufacturer's approved stand or legs, with the fixings provided, according to the instructions.

Don't allow electrical equipment to be exposed to rain or moisture.

ABOVE ALL

NEVER let anyone especially children push anything into holes, slots or any other opening in the case—this could result in a fatal electric shock.

NEVER guess or take chances with electrical equipment of any kind—it is better to be safe than sorry.

WARNING: Do not use cleaning agents containing ethyl alcohol, such as methylated spirits.

This equipment should be switched to standby when it is unattended for a few hours. This can be done using the remote control. However, for long periods of absence, switch off at the on/off switch on the front of the TV so that the red indicator light goes out. Make sure that your family know how to do this. Special arrangements may need to be made for infirm or handicapped people.

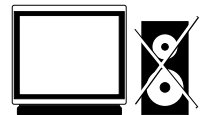
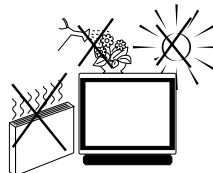
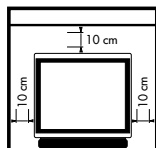
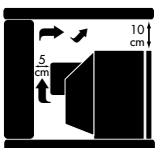

PERITELEVISION (SCART) PIN CONNECTIONS

Video inputs

Composite video or sync:
Pin 20 (pin 17 return).
RGB:
Red—Pin 15 (pin 13 return).
Green—Pin 11 (pin 9 return).
Blue—Pin 7 (pin 5 return).

Video output

Composite video:
Pin 19 (pin 17 return).

Audio inputs

A—Pin 6 (pin 4 return).
B—Pin 2 (pin 4 return).

Audio outputs

A—Pin 3 (pin 4 return).
B—Pin 1 (pin 4 return).

Fast blanking (input)

Pin 16, + 1V to +3V for fast blanking switching, 75Ω.

NOTE: if an unsynchronised TV picture results after viewing an external source (with a fast blanking signal) connected to AV, this voltage must be removed to return to TV mode.

Signal selection

Facilities are provided for automatic switching when the equipment connected provides switching voltages as follows:

Pin 8: +9.5V to +12V

- Auto switching to auxiliary O/AUX channel.

Pin 16: + 1V to + 3V—Auto switching to RGB.

Signal levels

Composite video (in/out): 1 V_{p-p} ±3dB, positive going, 75Ω.

Sync: 0.3V_{p-p}-3dB + 1OdB, negative going, 75Ω.

RGB (input): 0.7V_{p-p} ±3dB, positive going, 75Ω.

Audio (in/out): 0.5V r.m.s. (nominal)

Input impedance: ≥10 kΩ (20Hz-20kHz)

Output impedance: ≤ 1 kΩ (20Hz-20kHz).

SCART socket connections

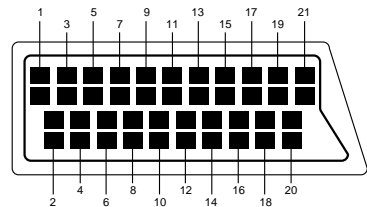

The socket is shown as viewed from the rear of the TV.

The descriptions and characteristics given here are of informative significance only, and non committal. In fact, to keep up the high quality of our products, we reserve the right to make changes or improvements without previous notice.

Guarantee

This guarantee is automatically effective from the date of purchase of the equipment. The appropriate sections should be completed by the dealer and purchaser at the time of purchase.

This guarantee should then be retained by the purchaser and kept safely so that it may be referred to and produced if required should a claim be made during the guarantee period.

Terms of Guarantee

1. The component parts used in this television receiver, with the exception of the colour picture tube, are guaranteed by Thomson multimedia Limited against failure due to faulty material or workmanship for a period of one year from the date of purchase. The colour picture tube is guaranteed separately for one year unless extended at the time of purchase, see "Picture Tube Guarantee".
2. Should the equipment fail to operate satisfactorily it should then be reported to the dealer from whom it was purchased who will normally be able to provide service and make any claim under guarantee on your behalf.
3. If it proves impossible to contact the dealer, you should contact the Thomson multimedia Limited Service Depot for advice stating the model and serial numbers, date of purchase, and the name and address of the dealer from whom it was bought.
4. This guarantee is effective in the United Kingdom only.
5. Thomson multimedia Limited reserves the right to vary the specifications of the equipment without notice.

Picture Tube Guarantee

The colour picture tube is separately guaranteed for twelve months free, or four years (optional extra) requiring registration. Ask your dealer for full details at the time of purchase.

This Guarantee in no way affects any statutory right of a consumer.

FOR COMPLETION BY THE PURCHASER

Purchaser's Name

Address

.....

PLEASE NOTE: It will not be necessary for the dealer or purchaser to return this guarantee to Thomson multimedia Limited when making a claim under guarantee, unless requested to do so, provided that the model and serial numbers, date of sale, and the purchaser's name and address are quoted on the order or advice note.

FOR COMPLETION BY THE DEALER

MODEL No.

SERIAL No.

DATE OF PURCHASE

Dealer's Stamp or Name and Address.



This publication is printed on 100% recycled paper.

THOMSON multimedia

CROWN ROAD
ENFIELD, MIDDLESEX EN1 1DZ
FERGUSON is a registered trade-mark

252 920 00

Free Manuals Download Website

<http://myh66.com>

<http://usermanuals.us>

<http://www.somanuals.com>

<http://www.4manuals.cc>

<http://www.manual-lib.com>

<http://www.404manual.com>

<http://www.luxmanual.com>

<http://aubethermostatmanual.com>

Golf course search by state

<http://golfingnear.com>

Email search by domain

<http://emailbydomain.com>

Auto manuals search

<http://auto.somanuals.com>

TV manuals search

<http://tv.somanuals.com>