

THOMSON

Thomson Lyra Jukebox User's Guide

PDP2842 / PDP2845

It is important to read this instruction book prior to using your new product for the first time.

Important Information

CAUTION

RISK OF ELECTRIC SHOCK DO NOT OPEN

To reduce the risk of electric shock, do not remove cover (or back). No user serviceable parts inside. Refer servicing to qualified service personnel.

Battery can only be repaired or replaced by qualified service personnel.



This symbol indicates "dangerous voltage" inside the product that presents a risk of electric shock or personal injury.



This symbol indicates important instructions accompanying the product.

WARNING

To reduce the risk of fire or electric shock, do not expose this product or AC charger to rain or moisture.

To reduce risk of injury, charge only rechargeable batteries recommended by the manufacturer for this product. Other types of batteries may burst causing damage and personal injury.

Sound Pressure Control



Les articles de loi L44.5 et 44.6 du code de la santé publique, modifiés par l'article 2 de la loi du 28 Mai 1996 imposent une puissance acoustique maximale de 100 décibels. Le casque livré (code 55700930) et votre appareil respectent la législation en vigueur.

A pleine puissance, l'écoute prolongée du baladeur peut endommager l'oreille de l'utilisateur.

Important Information

Service

This product should be serviced only by those specially trained in appropriate servicing techniques. For instructions on how to obtain service, refer to the warranty in this guide.

Product Registration

Please fill out the product registration card and return it immediately. Returning this card allows us to contact you if needed.

Product Information

Keep your sales receipt for proof of purchase to obtain warranty parts and service and attach it here. Record the serial number and model numbers — both numbers are located on the product.

Model No. _____

Purchase Date _____

Serial No. _____

Place of purchase _____

End User License Agreement

IMPORTANT-READ CAREFULLY:

This End User License Agreement ("Agreement") is a legal agreement between you and Thomson Inc. ("Thomson") for the Thomson Lyra device application/driver software program and associated documentation, if any ("Program").

ACKNOWLEDGMENT

BY INSTALLING THE SOFTWARE OR CLICKING ON THE ACCEPTANCE BUTTON OF THE SOFTWARE, COPYING OR OTHERWISE USING THE PROGRAM, YOU ACKNOWLEDGE AND AGREE THAT YOU HAVE READ THIS AGREEMENT, UNDERSTAND IT, AND AGREE TO BE BOUND BY ITS TERMS AND CONDITIONS. IF YOU DO NOT AGREE TO THE TERMS OF THIS LICENSE AGREEMENT, CLICK ON THE REJECTION BUTTON AND/OR DO NOT INSTALL THE SOFTWARE AND/OR DO NOT USE THE PROGRAM.

LICENSE

a) You are granted the license (i) to use the Program on a single workstation and (ii) to make one (1) copy of the Program into any machine-readable form for backup of the Program, provided the copy contains all of the original Program's proprietary notices.

b) You may transfer the Program and license, only as part of the Thomson Lyra device, to another party if the other party agrees to accept the terms and conditions of this Agreement. If you transfer the Program, you must at the same time either transfer all copies to the same party or destroy any copies not transferred.

LICENSE RESTRICTIONS

- a) Except for the licenses expressly granted to you in this Agreement, no other licenses are implied.
- b) You may not (i) modify, translate, reverse engineer, decompile, disassemble (except to the extent that this restriction is expressly prohibited by law) or create derivative works based upon the Program or (ii) copy the Program, except as expressly permitted herein. You agree that you shall only use the Program in a manner that complies with all applicable laws in the jurisdictions in which you use the Program, including, but not limited to, applicable restrictions concerning copyright and other intellectual property rights.
- c) The Program may contain pre-release code that does not perform at the level of a final code release. In this case, the Program may not operate properly. Updated versions of the Program can be downloaded from www.thomson-lyra.com.
- d) Thomson is not obligated to provide support services for the Program.

e) The Program is provided with "RESTRICTED RIGHTS". Use, duplication, or disclosure by the U.S. Government is subject to restrictions as set forth in subparagraph (c)(1)(ii) of DFARS 252.227-7013, or FAR 52.227-19, or in FAR 52.227-14 Alt. III, as applicable.

TERM AND TERMINATION

- a) The license is effective on the date you accept this Agreement, and remains in effect until terminated by either party.
- b) You may terminate this license without any notice or delay, by destroying or permanently erasing the Program and all copies thereof.
- c) If you use, copy, modify, or transfer the Program, or any copy, in whole or part, except as expressly provided for in this license, your license is automatically terminated.
- d) When the license is terminated, you must destroy or permanently erase the Program and all copies thereof.

End User License Agreement

WARRANTY DISCLAIMER

THE PROGRAM IS PROVIDED "AS IS" WITHOUT WARRANTY OF ANY KIND, EITHER EXPRESSED OR IMPLIED, INCLUDING, BUT NOT LIMITED TO THE IMPLIED WARRANTIES OF MERCHANTABILITY, FITNESS FOR A PARTICULAR PURPOSE, TITLE OR NON-INFRINGEMENT. THE ENTIRE RISK AS TO THE QUALITY AND PERFORMANCE OF THE PROGRAM IS WITH YOU. SHOULD THE PROGRAM PROVE DEFECTIVE, YOU (AND NOT THOMSON, ITS SUPPLIERS, ITS AFFILIATES OR ITS DEALERS) ASSUME THE ENTIRE COST FOR ALL NECESSARY REPAIR OR CORRECTION.

This exclusion of warranty may not be allowed under some applicable laws. As a result, the above exclusion may not apply to you, and you may have other rights depending on the law that applies to you

OWNERSHIP RIGHTS

All title and intellectual property rights in and to the Program and any copies thereof are owned by Thomson or its suppliers. All title and intellectual property rights in and to the content which may be

accessed through use of the Program is the property of the respective content owner and may be protected by applicable copyright or other intellectual property laws and treaties. This license grants you no rights to use such content.

LIMITATION OF LIABILITY

a) TO THE MAXIMUM EXTENT PERMITTED BY APPLICABLE LAW, IN NO EVENT SHALL THOMSON, ITS AFFILIATES, OR ITS DEALERS BE LIABLE FOR ANY SPECIAL, INCIDENTAL, INDIRECT OR CONSEQUENTIAL DAMAGES WHATSOEVER (INCLUDING, WITHOUT LIMITATION, DAMAGES FOR LOSS OF PROFITS, BUSINESS INTERRUPTION, CORRUPTION OF FILES, LOSS OF BUSINESS INFORMATION OR ANY OTHER PECUNIARY LOSS) REGARDLESS OF CAUSE OR FORM OF ACTION, INCLUDING CONTRACT, TORT OR NEGLIGENCE, ARISING OUT OF THE USE OF OR INABILITY TO USE THE PROGRAM, EVEN IF THOMSON HAS BEEN ADVISED OF THE POSSIBILITY OF SUCH DAMAGES. BECAUSE SOME STATES AND JURISDICTIONS DO NOT ALLOW THE EXCLUSION OR LIMITATION OF LIABILITY OF CONSEQUENTIAL OR INCIDENTAL DAMAGES, THE ABOVE LIMITATION MAY NOT APPLY TO YOU.

End User License Agreement

b) YOU ASSUME RESPONSIBILITY FOR THE SELECTION OF THE APPROPRIATE PROGRAM TO ACHIEVE YOUR INTENDED RESULTS, AND FOR THE INSTALLATION, USE, AND RESULTS OBTAINED.

WINDOWS MEDIA

This version of the Lyra Personal Digital Player ("Lyra Player") contains software licensed from Microsoft that enables you to play Windows Media Audio (WMA) files ("WMA Software"). The WMA Software is licensed to you for use with the RCA/THOMSON Portable Audio Device digital music player under the following conditions. By installing and using this version of the Lyra Player, you are agreeing to these conditions. IF YOU DO NOT AGREE TO THE CONDITIONS OF THIS END USER LICENSE AGREEMENT, DO NOT INSTALL OR USE THIS VERSION OF THE Lyra Player.

The WMA Software is protected by copyright and other intellectual property laws. This protection also extends to documentation for the WMA Software, whether in written or electronic form.

GRANT OF LICENSE. The WMA Software is only licensed to you as follows:

You may use this version of the Lyra Player containing the WMA Software only with the Portable Audio Device player.

You may not reverse engineer, decompile, or disassemble the WMA Software, except and only to the extent that such activity is expressly permitted by applicable law in spite of this limitation.

You may transfer your right to use this version of the Lyra Player only as part of a sale or transfer of your Portable Audio Device player, on the condition that the recipient agrees to the conditions in this End User License Agreement. If the version of the Lyra Player that you are transferring is an upgrade, you must also transfer all prior versions of the Lyra Player that you have which include the WMA Software.

End User License Agreement

MICROSOFT IS NOT PROVIDING ANY WARRANTY OF ANY KIND TO YOU FOR THE WMA SOFTWARE, AND MICROSOFT MAKES NO REPRESENTATION CONCERNING THE OPERABILITY OF THE WMA SOFTWARE.

The WMA Software is of U.S. origin. Any export of this version of the Lyra Player must comply with all applicable international and national laws, including the U.S. Export Administration Regulations, that apply to the WMA Software incorporated in the Lyra Player.

THIRD PARTY SOFTWARE

ANY THIRD PARTY SOFTWARE THAT MAY BE PROVIDED WITH THE PROGRAM IS INCLUDED FOR USE AT YOUR OPTION. IF YOU CHOOSE TO USE SUCH THIRD PARTY SOFTWARE, THEN SUCH USE SHALL BE GOVERNED BY SUCH THIRD PARTY'S LICENSE AGREEMENT, AN ELECTRONIC COPY OF WHICH WILL BE INSTALLED IN THE APPROPRIATE FOLDER ON YOUR COMPUTER UPON INSTALLATION OF THE SOFTWARE. THOMSON IS NOT RESPONSIBLE FOR ANY THIRD PARTY'S SOFTWARE AND SHALL HAVE NO LIABILITY FOR YOUR USE OF THIRD PARTY SOFTWARE.

GOVERNING LAW

This Agreement is governed by the laws of France, without regard to its conflict of laws.

GENERAL TERMS

This Agreement can only be modified by a written agreement signed by you and Thomson, and changes from the terms and conditions of this Agreement made in any other manner will be of no effect. If any portion of this Agreement shall be held invalid, illegal, or unenforceable, the validity, legality, and enforceability of the remainder of the Agreement shall not in any way be affected or impaired thereby. This Agreement is the complete and exclusive statement of the agreement between you and Thomson, which supersedes all proposals or prior agreements, oral or written, and all other communications between you and Thomson, relating to the subject matter of this Agreement.

Table of Contents

Important Information	2
Warning	2
End User License Agreement	4
Table of Contents	9
Before You Begin	12
Unpacking Your Unit	12
Things to consider before you get started... ..	13
Computer System Requirements	13
Warning	13
Caution	13
Caution While Driving	13
Back up your data	14
Important Battery Information	14
Getting Started : Software Setup	15
Inserting the Included CD-ROM into CD-ROM Drive	15
Installing Software Components	16
Install the USB Driver (Windows 98SE and Me Only)	16
Install System Applications	17
Install MusicMatch Jukebox	18
Install Additional Services	19
Launch the MusicMatch software	19
Install MusicMatch Plug-in	19
The MusicMatch icon found in your computer's system tray	19
Connecting Thomson Lyra to the Computer	20
Transferring Files to Thomson Lyra Jukebox	21
Transfer Files via MusicMatch Jukebox	21
Transfer Files via Windows Explorer (Drag and Drop)	22
Create Pre-defined Playlists and Transferring them to the Jukebox	23

Table of Contents

Disconnecting Your Lyra from the Computer	24
System Tray Applications	25
Profile	25
Verify User Playlists	26
Updating System File	26
LyraSync	27
MyDislikes	28
Lyra•Jukebox	29
Overview of General Controls	29
Front View	29
Navigation Controls	29
Left View	30
Right View	31
Top View	31
Display Overview	32
Menu Navigation	33
Basic Operation	33
Selecting Music Mode	34
Music Playback Display	34
Music Playback Operation	35
Step-by-Step Example	36
Navigation Menu	38
Playlists	40
My Selections	40
My Dislikes	42
View User Playlists	43
Pre-defined Playlists	44
Save MySelections or MyDislikes as a Playlist	44
Clear Playlists	45
All Files	46
Additional Features	47
Repeat	47
Shuffle	48
Profiler	51

Table of Contents

Selecting Radio Mode	52
Preset Station	52
Tuning to a Station	52
Setting Preset	53
Selecting Preset Station	54
Clearing Preset	54
Suppressing Stereo Signal	54
Record FM Radio	55
View FM Recording	56
Selecting Recording Duration	56
Selecting Recording Quality	56
Delete FM Recording	57
System Settings	58
Customize Music Menu	59
System Info	60
Connecting your Thomson Lyra Jukebox to your Car Stereo	61
Connecting Your Thomson Lyra Jukebox on your stereo system	62
Check for Updates	63
Portable Hard Drive Capability	63
Tips and Troubleshooting	64
FAQ (Frequently Asked Questions)	66
Specifications & System Requirements	66
Hardware	66
Hard Disc	67
Software	67
PC Hardware Requirements	68
Accessories	68
Miscellaneous Specifications	68
Repair Centers - Hungary	69
Repair Centers - Poland	70
Repair Centers - Russia	71
Repair Centers - Czech Republic	73

Before You Begin

Unpacking Your Unit

Your Lyra Jukebox came with everything you need to make music portable — all of the items shown below should have been packed in the box with your Lyra Jukebox.



Thomson Lyra Jukebox



Music Management CD
Contains the Lyra Jukebox applications & MusicMatch Jukebox software



AC/DC adapter charger



Mini USB cable
Plug the small end into the USB on your Lyra Jukebox, and plug the other end into your computer's USB port.
Go to page 20 for connection details.



Line out cable
Connects Lyra Jukebox to your audio system.
For details, go to page 62.



Car adapter kit
Car cord adapter / cassette adapter
Go to page 61 for instructions.



Clip Phones
Go to page 37 for instructions.

Illustrations contained within this publication are for representation only and subject to change.

Things to consider before you get started...

Computer System Requirements

- Pentium III 500MHz or higher recommended
Macintosh iMac G3 or higher
- Windows @98SE, Me, 2000, or XP
Mac OS X Version 10.1.5 or higher
- Internet Explorer 4.0 or higher
- Internet access
- 100MB free hard disk space for the software
- 64MB RAM (128 MB recommended)
- CD-ROM drive capable of digital audio extraction
- USB port (2.0 recommended)
- Installed sound card
- 16- bit color video card

Warning

Use of this product is for your personal use only . Unauthorized recording or duplication of copyrighted material may infringe upon the rights of third parties and may be contrary to copyright laws.

Caution

- Keep product out of direct sunlight. Exposure to direct sunlight or extreme heat (such as inside a parked car) may cause damage or malfunction.
- Do not expose to rain or moisture.

Caution While Driving

Use of headphones while operating an automobile or moving vehicle is not recommended and is unlawful in some states and areas. Be careful and attentive on the road. Stop operation of the unit if you find it disruptive or distracting while driving.

Before You Begin

Back up your data

As with any portable device that has a hard drive, you must back up the drive regularly. RCA and Thomson are not responsible for lost data.

Important Battery Information

- The battery used in this device may present a risk of fire or chemical burn if mistreated. Do not separately recharge, disassemble, heat above 100C (212F), or incinerate.
- **Battery replacement should only be made by trained technicians. Refer to Thomson Warranty for details.**
- Do not attempt to open the unit. No user servicable parts inside.
- To reduce risk of injury, charge only rechargeable batteries recommended by the manufacturer for this product. Other types of batteries may burst causing damage and personal injury.
- Keep the unit away from children. Do not disassemble or dispose product in fire.
- Use only the specified chargers which were packaged with the product. Use of another charger may present a risk of fire or explosion.

Getting Started: Software Setup

The Music Management CD that came with your Lyra Jukebox contains all of the necessary software components you need to make your Lyra Jukebox work properly.

These components do the following:

- install USB driver for Windows 98SE/Me users (Refer to page 16)
- enable you to transfer files from your computer to your Lyra Jukebox
- profile, format and sort the contents, update the system files (Refer to page 25)
- use the MusicMatch Jukebox software to organize your music collection and transfer the music to your Lyra Jukebox

The MusicMatch Jukebox™ software compresses audio files (from music CDs) to the mp3, mp3PRO or Windows Media Audio (WMA) format so you can play them on your Lyra Jukebox. The MusicMatch software also enables you to download files from the internet that are already compressed and then transfer those files to your Lyra Jukebox (or play the music on your computer).

Inserting the Included CD-ROM into CD-ROM Drive

Note: Do not connect your Lyra Jukebox to your computer before you have installed the required drivers. (Windows 98SE/Me only)

1. Turn on your computer and place the Music Management CD that came with your Lyra Jukebox into your computer.

IMPORTANT: Don't connect the USB cable to the PC or Lyra Jukebox before or during the driver installation.

If you're running Windows 2000, no additional drivers are required.

*If you're running Windows 98SE/Me, you **must** install the USB drivers from the CD-ROM in order for the Lyra Personal Jukebox to function properly.*

Getting Started: Software Setup

2. If the setup screen does not appear, double click *My Computer*, double click your CD-ROM drive icon, and double click *Install* to run the installer.

The Lyra Jukebox and MusicMatch Jukebox quick start program runs.



3. Select your Thomson Lyra model on the startup screen and click *Install* to access installation programs corresponding to your Lyra device.



4. Click on the software component you want to install. See next Section for details.

Installing Software Components

Install the USB Driver (Windows 98SE and Me Only)

For Windows 98SE and Me systems, you need to install a USB driver before your computer can recognize your Lyra Jukebox.



1. Click *Install USB Driver/System Applications* to install the required driver for your Lyra Jukebox.
2. Follow the on-screen instructions to install all necessary files.
3. Click *Finish* to complete installation and return to the startup screen.

Install System Applications



1. Click *Install System Application* to install applications that will help you better manage your Lyra Jukebox.

Note: The installation program will detect whether your system requires a USB driver. If you see the *Install USB driver/System Applications* option, click it to install the USB driver. (Refer to the previous section for details). The program will install the USB driver first, restart the computer, and then begin to install the System Application software.

2. Follow the on-screen instructions to install all necessary files.
3. Click *Finish* to complete installation and return to the startup screen.

(Refer to page 25 for further system application details)

Getting Started: Software Setup

Install MusicMatch Jukebox

MusicMatch Jukebox is a music management software used to organize and manage digital audio files and can be used to transfer the music to your Lyra Jukebox.



1. Click *Install MusicMatch Jukebox* to run the MusicMatch setup program.

Wait while the installation program begins. It may take up to 20 seconds for the installer to start.

Note: *It is recommended to uninstall any previous installations of the MusicMatch Jukebox software before proceeding. After the uninstall process has been completed, delete the MusicMatch folder found under C:\Program Files. If you do not wish to uninstall the previous MusicMatch Jukebox software, go to "Install MusicMatch Plug-in" on page 19.*

2. Follow the on-screen instructions to complete MusicMatch installation.

For more information on MusicMatch Jukebox, click *Tutorials* on the CD or go to www.musicmatch.com.



Getting Started: Software Setup

Install MusicMatch Plug-in

MusicMatch requires a plug-in for your particular device in order to transfer files from your computer to your Lyra Jukebox.



1. Click *Install MusicMatch Plug-in*.
2. Follow the on-screen instructions to install all necessary files.
3. Click *Finish* to complete installation and return to startup screen.

Install Additional Services

Click on *Install ID3man by Auditude*, *Get 100 Free mp3 Tracks from eMusic*, *Moodlogic* or *Try Rhapsody Music services* for additional digital music services provided by our partners.

Launch the MusicMatch software



The MusicMatch icon found in your computer's system tray.

The MusicMatch software converts audio files to the mp3, mp3PRO and WMA format so you can play them on your Lyra Jukebox.

1. Remove the Music Management CD from your computer.
2. Start the MusicMatch Jukebox software (double click on the MusicMatch icon in your system tray or on your desktop).

Getting Started: Software Setup

Connecting Thomson Lyra to the Computer

Connect the Lyra Jukebox to your computer with the mini USB cable provided. Turn on the unit by pressing the **ON** button. Press and hold the **Play** button to start USB transfer. The Lyra Jukebox will appear as a Removal Disk drive letter.

Note: *It might take several seconds for the device (the Lyra Jukebox) to be detected, especially in Windows 2000/XP. Click Refresh in My Computer or Explorer to make sure the device has been detected.*

Note: *The Lyra Jukebox is capable of transferring files at hi-speed mode of USB 2.0. This is up to 40 times faster than USB 1.1. If USB 2.0 port is available on your computer, use it to connect to your Lyra Jukebox. The Lyra Jukebox is still backward compatible with the older USB 1.1 ports. However, you will not be able to take full advantage of the potential speed increase.*

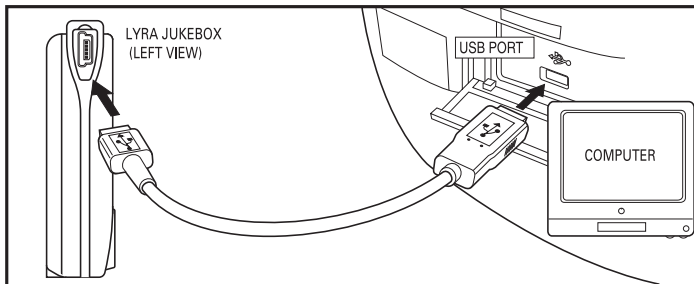

Transferring Files to Thomson Lyra Jukebox

You can transfer files to your Lyra Jukebox via MusicMatch Jukebox or via Windows Explorer.

If your Lyra Jukebox isn't already connected to your computer, connect the Lyra Jukebox to the computer using the provided USB cable as illustrated above.

Note: *The USB port acts as a power source for your Lyra Jukebox.*

Note: *Do not disconnect the USB cable during music download. Doing so may corrupt system files or the files being downloaded.*

Transfer Files via MusicMatch Jukebox

1. Drag and drop desired tracks from the *Music Library* to the *Playlist* display and save the playlist.

Note : *Be sure to save the playlist or it will not be displayed on the playlist window of the Portable Device Manager screen.*

2. From the menu area, select *Files/Send to Portable Device* or click *Send to Portable* under the copy item on the left side of the MusicMatch Jukebox screen to display the Portable Device Manager screen.
3. Click on *Options* and select your portable device under *Select Device*. Click *OK*. Your device should be listed under *Portable Device*.
4. Select the playlist item and drag it to the active device listed under *Portable Device*. Only those playlists saved in step 1 are displayed on the playlist window. The songs in the playlist will now be automatically transferred to your Lyra Player.

USB 2.0
Hi-speed capable
connected...
Do not unplug

During transfer a progress indicator appears in the *Portable Device Manager* screen, and "Do not unplug" flashes in the Lyra Jukebox's LCD.

Getting Started: Software Setup

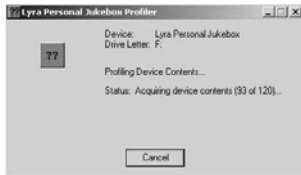

When the transfer is finished, the *Lyra Personal Jukebox Profiler* application may automatically run so it can sort/profile the newly transferred files.

You can run the profiler manually by right clicking on the Lyra icon on the System Tray Area. Refer to page 25 for details.

Caution: Make sure all data are transferred to the Lyra Jukebox before unplugging the USB cable.

If you're running Windows 2000 you must stop the device before unplugging it. Click the  icon (the Unplug or Eject hardware icon) from the system tray and select the USB Mass Storage device for the drive letter associated with the Lyra Jukebox, and select the device you want to stop. See the Windows Help for details about the Unplug or Eject Hardware topic.

Transfer Files via Windows Explorer (Drag and Drop)

If your Lyra Jukebox isn't already connected to your computer, connect the Lyra Jukebox to the computer using the provided USB cable as illustrated on page 20 and turn on the unit.



From Windows Explorer, highlight all the files/folders you want to transfer to your Lyra Jukebox and drag them to the drive letter that is associated with it.

Note: You must profile your contents after file transfer in order for the new files to appear in the Navigation Menus. Refer to page 25 for profiling details.

Create Pre-defined Playlists and Transferring them to the Jukebox

Pre-defined playlists can be created on your PC using MusicMatch Jukebox. Refer to the MusicMatch Jukebox User Manual for details. Note that only playlists created with songs stored on the Lyra Jukebox will work on the Lyra. Use Windows Explorer to transfer pre-defined playlists to your Lyra Jukebox.



If your Lyra Jukebox isn't already connected to your computer, connect it using the provided USB cable and turn the unit on.

From Windows Explorer, highlight the pre-defined playlists that you have created in MusicMatch Jukebox and drag them to the *lyra_playlists* directory in the drive letter associated with your Lyra Jukebox.

Note: You must profile your contents after file transfer in order for the new files to appear in the Navigation Menus. Refer to page 25 for profiling details.

Getting Started: Software Setup

Disconnecting Your Lyra from the Computer

USB 2.0
Hi-speed capable
connected...
Safe to unplug

Note: Before disconnecting the USB cable from the computer or the Lyra Jukebox, be sure the "Safe to unplug" message is displayed.



From the System Tray, double click the left mouse button on the icon  and select *Unplug or eject hardware*. Select the drive corresponding to your Lyra player.



The *Stop a Hardware device* screen appears. Select the device to be stopped again for confirmation and click *OK*.

You can also stop your Lyra Jukebox by right clicking on the  icon from the system tray and selecting the drive corresponding to your player.

System Tray Applications

Profile

New files that are transferred to your Lyra Jukebox using Windows Explorer (drag and drop) will not appear in the Navigation Menus until you profile the contents. If MusicMatch Jukebox was used to transfer files, profiling will be done automatically.

1. Connect your Lyra Jukebox to the computer using the provided USB cable if it is not already connected and turn the unit on.



2. Right click on the Lyra icon  in the System tray (bottom right hand corner of the computer screen).



3. Select the *Profile Device Content...* item to start the profiling and sorting contents.

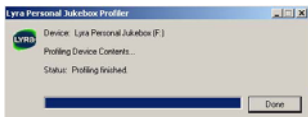

4. Click *Done* when profiling is complete.

Caution: Make sure all data are transferred to the Lyra Jukebox before unplugging the USB cable.

If you're running Windows 2000 you must stop the device before unplugging it. Click the  icon (the Unplug or Eject hardware icon) from the system tray and select the USB Mass Storage device for the drive letter associated with the Lyra Jukebox, and select the device you want to stop. See the Windows Help for details about the Unplug or Eject Hardware topic.

Note: The Lyra Jukebox can also perform profiling. Refer to page 51 for details.

Getting Started: Software Setup

Updating System File

You can upgrade your Lyra Jukebox or repair damaged system files on your device by downloading the latest firmware from <http://www.thomson-lyra.com>. After you have downloaded the latest firmware, follow the steps below to update your system files.

1. Connect your Lyra Jukebox to the computer using the provided USB cable if it is not already connected and turn the unit on.



2. Right click on the Lyra icon  in the System tray (bottom right hand corner of the computer screen) and select the *Update System File...* item to start updating your system with the latest firmware.

Possible cause of system file damage:

- System files and/or folders were accidentally deleted from the device,
- You have formatted your Jukebox.

Verify User Playlists

Verify items in the User Playlists under the *lyra_playlist* system folder exists on the Lyra Jukebox.

1. Connect your Lyra Jukebox to the computer using the provided USB cable if it is not already connected and turn the unit on.



2. Right click on the Lyra icon  in the System tray (bottom right hand corner of the computer screen) and select the *Verify User Playlists...* item.

LyraSync

Files and folders can be synchronized between your PC and your Lyra Jukebox.

1. Connect your Lyra Jukebox to the computer using the provided USB cable if it is not already connected and turn the unit on.



2. Right click on the Lyra icon  in the System tray (bottom right hand corner of the computer screen) and select *LyraSync*.



3. The *LyraSync Options* screen appears.

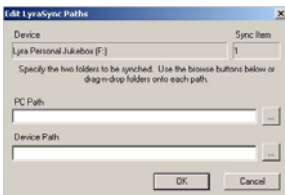

4. Click *Insert* to select the paths of files and folders to synchronize between your PC and the Device. Click *OK*.

5. Select the desired LyraSync direction.

- PC overwrites Device
- Device overwrites PC
- Synchronize PC and Device

6. Click *Synchronize* to start.

Getting Started: Software Setup

MyDislikes

Items in the *MyDislikes* playlist can be viewed and deleted in *MyDislikes*.

1. Connect your Lyra Jukebox to the computer using the provided USB cable if it is not already connected and turn the unit on.



2. Right click on the Lyra icon  in the System tray (bottom right hand corner of the computer screen) and select *MyDislikes...*

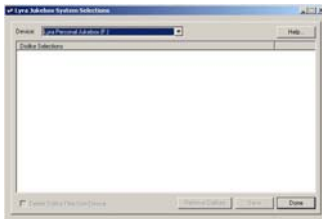

3. Files tagged as dislike on the unit will show on the *Lyra Jukebox MyDislikes* screen. Highlight files to remove from the *MyDislikes* playlist and click *Remove Dislikes*.

Note: Files will be removed from your Lyra Jukebox, playlist and *MyDislikes* playlist permanently.

4. Press *Done* to close the *MyDislikes* screen.

Overview of General Controls

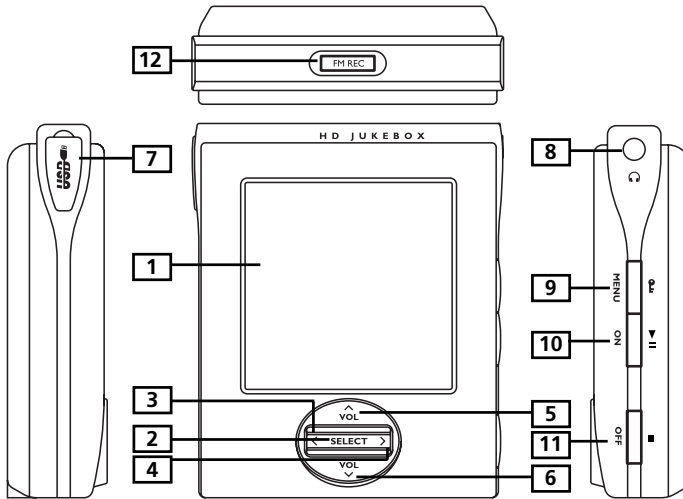

Front View

- 1 LCD (Liquid Crystal Display)**- This is where the Lyra's user interface appears (go to page 34 for an explanation of the items that appear on the LCD during playback).

Navigation Controls





- 2 SELECT** - Selects a highlighted item in navigation mode. During music menu navigation, press SELECT to tag any item to be included in the *MySelections* playlist. These items can be individual songs, or a group of songs under an artist, album, etc. Press SELECT on a tagged item to remove it from *MySelections* playlist. During music playback, press SELECT to add the current song to the *MySelections* or *MyDislikes* playlist. In radio mode - Saves the current radio station as a preset station.

- 3 Up(↵)** - Scrolls up Lyra Jukebox menu and moves the highlight up.
During music and radio playback - Increases volume level.
- 4 Down(⏮)** - Scrolls down Lyra Jukebox menu and moves the highlight down.
During music and radio playback - Decreases volume level.
- 5 Enter/Next (⏭)** - Enters the highlighted item.
 - Views the content of the highlighted item.
 - Shows info screen during menu navigation when the item selected is a song.
 - In music mode - press and release to skip forward to the next song. To scan forward in the current song, press and hold.
 - During preset tuning in radio mode - Selects the next preset station.
 - During manual tuning in radio mode - Tunes up radio frequency.
- 6 Back/Previous (⏪)** - Returns to the previous menu.
 - In music mode - Press and release to skip back to the beginning of the song or the previous song. To scan backwards in the song that's playing, press and hold.
 - During preset tuning in radio mode - Selects the previous preset station.
 - During manual tuning in radio mode - Tunes down radio frequency.

Left View

- 7 USB port** - Attach the small end (Type mini-B) of the mini-USB cable here. Attach the large end (Type A) to your computer. The Lyra Jukebox will also get power from the USB port when connected. Plug in the AC power adapter here. When you plug in the AC adapter, the battery inside the Lyra Jukebox automatically starts charging.

Right View

- 8 Headphones jack ()**  - Insert the headphones plug here.
- 9 ON/Play/Pause (▶)**  - When the power is off, press to turn on the unit. When the unit is on in music mode, press to play or pause music. In radio mode, press to select between tune and preset mode. Press and hold to switch between music and radio mode.
- 10. OFF/Stop (■)/Reset**  - When the unit is in stop mode, press to turn the power off. When music is playing, press to stop playback. During radio recording, press to stop recording. When the unit does not respond, press and hold for more than 10 seconds to reset the unit.
- 11. MENU/Lock ()**  - Accesses the Menu.
- Press and hold to activate and deactivate key lock.

Top View

- 12. FM REC** - Starts or pauses radio recording.

Display Overview

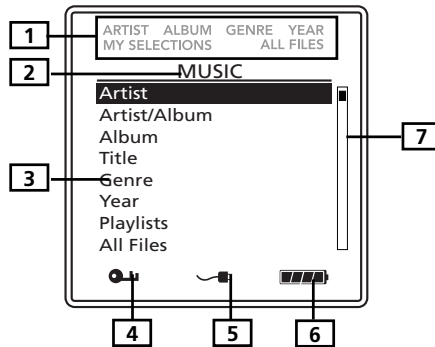

- 1 The relative icon lights to show the sorting method of the current folder.
- 2 The menu level you are currently at.
- 3 The items in the current menu level.
- 4 The lock icon is displayed when the key lock function is activated. This can be activated by pressing and holding the **MENU/ Lock** button until the lock icon is displayed. To unlock, press and hold again until the lock icon is turned off.
- 5 Charger is connected.
- 6 The battery indicator shows battery level.
■ ■ ■ ■ - Battery full
□ - Battery empty
- 7 The current position you are at among all other items in the current menu level.

Basic Operation

The information in this section presumes you've successfully transferred files to your Lyra Jukebox, and you're ready to play some music.

If you need specific set-up information (downloading music, transferring files, installing software), go to "Getting Started: Software Setup" on page 15-28.

If you want more detailed information about the Lyra Jukebox's features, go to page 29.

Understanding how to navigate through the Lyra Jukebox's menu system, combine with how the buttons operate, will give you information you need for basic functionality.

Menu Navigation

- 1 To scroll up and down and highlight items on screen, press the **Up () ^** or **Down () v** arrow.
- 2 To enter and view the submenu, press the **Enter/Next () >** arrow button.
- 3 To go back to the previous menu level, press the **Back/Previous () <** arrow button.
- 4 To view the menu at any given time, press the **MENU** button.

Music Menu

MENU	
▶ Go to Radio	
Repeat	Off
Shuffle	Off
DSP	Flat
Profile Content	
Settings	
System Info	

Radio Menu

MENU	
▶ Go to Music	
Clear Preset	
Mode	Stereo
RecDur	30min
RecQua	High
Settings	
System Info	

Selecting Music Mode

MENU	
▶ Go to Music	
Clear Preset	
Mode	Stereo
RecDur	30min
RecQua	High
Settings	
System Info	

1. If the unit is in radio mode, press the **MENU Lock ()** button to view the Radio menu.
2. Use the **Up()** or **Down()** arrows to select *Go to Music* and press **SELECT** for music mode.

Music Playback Display

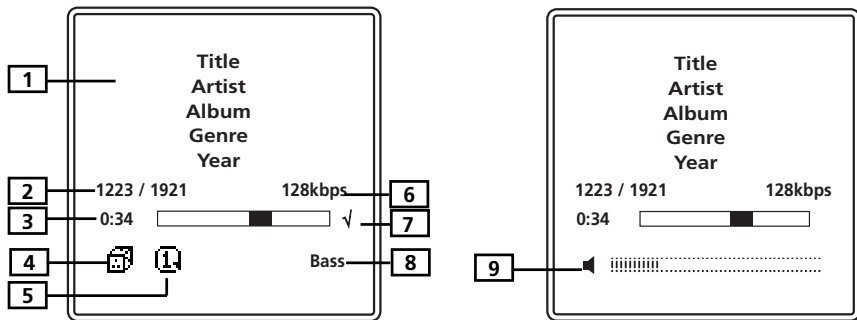

- 1 Displays song information.
- 2 The current song number out of the total number of songs on the unit.
- 3 Song elapse time.
- 4 Random icon.
- 5 The repeat icon is displayed when the repeat feature is activated.
 - ① - Indicates repeat one song
 - ② - Indicates repeat all songs in the current play mode.
- 6 Shows mp3 Bitrate and song format (mp3 / mp3PRO / wma).
- 7 √ - Indicates the song is included in the *MySelections* playlist.
x - Indicates the song is included in the *MyDislikes* playlist.
- 8 Current DSP selection (Flat / Bass / Rock / Pop / Jazz / Graphic EQ).
- 9 The volume bar shows on the display for a few seconds when the volume is adjusted.

Music Playback Operation

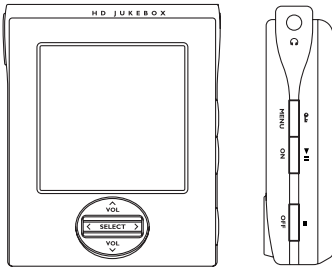

- Once the item that you want to play is on the screen, press **Play/Pause** () ►|| to begin playback. This item can be an artist, an album, a playlist, or a song. Press again to pause playback. The unit will automatically power off after remaining in pause mode for more than the Power Save interval (length of this Power Save interval can be modified in the *Setting* menu).
- To scan backwards in the track that's playing, press and hold the **Back/Previous** ()◀ button.
- To scan forward in the track that is playing, press and hold the **Enter/Next** ()> button.
- To go to the next track, press and release the **Enter/Next** ()> button.
- To go to the previous track, press and release the **Back/Previous** ()◀ button.
- To stop playback, press the **Stop** ()■ button on the side of the unit. The display returns to the previous menu level.
- To turn up the volume, press **VOL** ()^ . The volume bar updates to show the increase in volume level.
- To turn down the volume, press **VOL** ()v . The volume bar updates to show the decrease in volume level.
- To add an item to *MySelections* list, press **SELECT** to tag it (in navigation mode or during playback). You can add an album, an artist, or individual songs. Songs saved in this list can be played and viewed through the *Playlists* menu.
- To add a song to the *MyDislikes* list, press the **SELECT** button to tag the song. (only active during playback).
- To access the song information screen, press **Enter/Next** ()> in navigation mode.

Step-by-Step Example

The following example illustrates (with more detail than the previous information) how you find the song you want to play .

1. These instructions presume you've already done the following:
 - Installed the MusicMatch Jukebox software and the Lyra Jukebox profiler application (go to page 25 for detailed instructions).
 - Transferred music from your computer to the Lyra Jukebox (page 18 has detailed instructions) and profiled the contents of the Lyra Jukebox through MusicMatch Jukebox or the Profiler software.

Note: *The music you're transferring could be from a CD you put in your computer, the internet, or music you already had loaded onto your computer.*

2. If you haven't already unplugged the Lyra Jukebox from your computer, disconnect the USB cable from the Lyra Jukebox.

Note: *If you're running Windows 2000, you must stop the device before unplugging it. Click the  icon (the Unplug or Eject hardware icon) from the system tray and select the USB Mass Storage device for the drive letter associated with the Lyra Jukebox, and click STOP. See the Windows Help for details about the Unplug or Eject Hardware topic.*

3. If you've fully charged the battery (the Lyra Jukebox needs to be plugged in for about 4 hours before the battery is fully charged), the display shows "Batteries fully charged.". Disconnect the AC adapter from the outlet and then from your Lyra Jukebox.

Note: *If the battery isn't fully charged, keep the Lyra Jukebox plugged in while you listen to the music you've transferred from your computer.*

4. Connect the clip phones to your Lyra Jukebox (insert the end of the clip phones connector into the phones jack on the side of the Lyra).

How to Use Your Clip Phones (The e.clipz)



The right ear clip phone is labeled R while the left ear clip phone is labeled L.

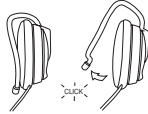

- a. Pull the ear hook away from the ear pad slightly. You will hear a click sound.



- b. Slide the ear hook behind the ear with the ear pad on the front of the ear. Rotate the clip phone so the ear pad fits closely with the ear.

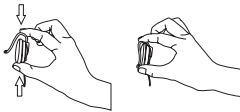

- c. Lock the clip phone in place by pushing down on the top of the ear hook until it locks.



- d. For best sound quality, make sure the earpad fits closely with your ear.

5. If your Lyra Jukebox isn't already on, turn it on (press the **ON / Play / Pause (▶||)** button). The Thomson Lyra logo flashes on the screen, and then the main *Menu* appears.

Navigation Menu

The following example illustrates steps to select and play songs in the *Artist* category.

-
- MUSIC**
- ▶ Artist
 - Artist/Album
 - Album
 - Title
 - Genre
 - Year
 - Playlists
 - All Files

-
- ARTIST**
- Artist 1
 - ▶ Artist 2
 - Artist 3
 - Artist 4
 - Artist 5
 - Artist 6

-
- ARTIST 2**
- ▶ Artist 2 Song 1
 - Artist 2 Song 2
 - Artist 2 Song 3
 - Artist 2 Song 4
 - Artist 2 Song 5
 - Artist 2 Song 6

1. Highlight *Artist* (use the **Up** (^) or **Down** (v) arrow button).
2. Press the **Enter / Next** (>) button (the *Artist* menu appears with the artists stored on your Lyra Jukebox listed in alphabetical order).
 - To scroll up and down the *Artist* menu, press the **Up** (^) or **Down** (v) arrow button.
 - To return to the main *Music* menu, press the **Back / Previous** (<) arrow button.
3. To view the songs for the artist highlighted, press **Enter / Next** (>) (the songs for that artist appear in alphabetical order).
 - To scroll up and down and view the list of songs for the selected artist, press the **Up** (^) or **Down** (v) arrow button.
 - To return to the previous menu (*Artist*), press the **Back / Previous** (<) arrow button.

Note: To show the Music Menu at any stage of navigation, press **MENU**.

Title 1
Artist 1
Album 1
Genre
Year
1/10 128kbps
0:10 

Highlight the desired song.

- To play the song, press the **Play / Pause (▶||)** button.
- To end playback, press the **Stop (■)** button.
- To get more info about the song, highlight the desired song in navigation mode and press the **Enter / Next (➤)** arrow button .

SONG INFO

Artist: Artist 3
Album: Album 1
Title: Title 4
Genre: Pop
Year: 2002
File: \Music\Title 4.mp3

Note: *The information provided in the INFO screen depends upon the ID3 tags that have been set up for the song.*

- To go to the previous menu, press the **Back / Previous (◀)** arrow button.

Playlists

Lyra Jukebox has 2 System Playlist selections: *MySelections* and *MyDislikes*.

My Selections

You can create a *MySelections* temporary playlist using the Lyra Jukebox.

- ▶ - The song is included in *MySelections*.
- ▶ - If the item is a folder, all the songs in the folder is included in *MySelections*.
- ▷ - If the item is a folder, some of the songs in the folder is included in *MySelections*.

ALBUM 1

- Song 1
- ▶ Song 2
- Song 3
- Song 4
- Song 5
- Song 6

1. In navigation mode, move the cursor to highlight the item to be selected.
 - To scroll up and down the display, press the **Up** (^) or **Down** (v) button.
 - To enter the highlighted folder, press the **Enter / Next** (>) button.
 - To go back to the previous folder, press the **Back / Previous** (<) button.
 - To view music sub-menu, press the **MENU** button.

ALBUM

- Album 1
- ▶ Album 2
- Album 3
- Album 4

Title 1
Artist 1
Album 2
Genre
Year
11/100 128kbps
0:10  ✓

ALBUM 1

- Song 1
- ▶ Song 2
- Song 3
- Song 4
- Song 5
- Song 6

2. If the item is an item (artist, album, etc.), press **SELECT** to tag all the songs belonging to the selected item and place them into the *MySelections* playlist.

If the item is a song, press **SELECT** to tag the song and place it into the *MySelections* playlist.

The relative icon (▶ or ▶) will show beside any folder or song that has been tagged.

During playback, a ✓ icon is displayed to show the song is included in *MySelections* playlist.

3. To de-select a selected item, use the navigation buttons to highlight the selected item and press **SELECT**.

Refer to "View User Playlist" on page 43 to view items in the MySelections playlist.

To clear MySelections playlist, refer to "Clear Playlists" on page 45.

Note: *MySelections is not active in All Files mode.*

My Dislikes

In playback mode, you can tag songs you don't like and place them into the *MyDislikes* playlist.



1. When a song is playing, press the **SELECT** button.
2. Press **Up** (↑) or **Down** (↓) to select *MyDislikes*.
Press **SELECT** to tag the song and add it to the *MyDislikes* playlist.
The x icon will show on the bottom right corner of the display to show the song has been tagged as a "dislike" song.
3. To de-select a song from the *MyDislikes* playlist, press the **SELECT** button again while the song is playing.

Note: To clear the *MyDislikes* playlist, refer to "Clear Playlist" on page 45.

Note: You can also view the *MyDislikes* playlist on your computer where songs that have been marked can be viewed or deleted. (Refer to System Tray Applications on page 25)

View User Playlists

MUSIC

- Artist
- Artist/Album
- Album
- Title
- Genre
- Year
- ▶ Playlists
- All Files
- Radio Recordings

1. Use the **Up (^)** or **Down (v)** button to scroll and highlight *Playlists* from the *Music* menu.
2. Press **Enter / Next (>)** to show pre-defined and system playlists.

PLAYLISTS

- ▶ MySelections
- MyDislikes
- Playlist1
- Playlist2
- Playlist3

3. Scroll up and down the *Playlists* menu to select the desired playlist to be viewed using the **Up (^)** or **Down (v)** button.

MYSELECTIONS

- Song 1
- ▶ Song 2
- Song 3
- Song 4

4. Press **Enter / Next (<)** to view tagged items in the selected playlist.

Pre-defined Playlists

Pre-defined playlists are those playlists created on the PC and transferred to the Lyra Jukebox. Refer to page 23 for details on creating Pre-defined Playlists and transferring them to your Lyra Jukebox.



Follow the steps under "View System Playlists" to enter the *Playlists* menu.

All playlists except for *MySelections* and *MyDislikes* playlists are pre-defined playlists

Note: *Pre-define Playlists can not be edited on the device.*

Save MySelections or MyDislikes as a Playlist

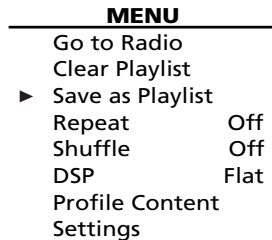

1. Press **MENU** when the cursor is pointing to *MySelections* or *MyDislikes*.
2. Press **Up** (↶) or **Down** (↷) to select *Save as Playlist* and press **SELECT**.

SAVE AS PLAYLIST

Save MySelections

as :

Playlist3

3. Name the playlist using the arrow buttons.
Press **Enter / Next** (→) to move the cursor to the right.
Press **Back / Previous** (←) to move the cursor to the left.
Press **Up** (↑) or **Down** (↓) to select a number or a letter.

PLAYLISTS

MySelections

MyDislikes

Playlists1

Playlists2

▶ Playlists3

4. Press **SELECT** to save.

Clear Playlists

PLAYLISTS

▶ MySelections

MyDislikes

Playlist1

Playlist2

Playlist3

1. Press **MENU** when the cursor is pointing to the system playlist to be cleared (*MySelections* or *MyDislikes*).

MENU

Go to Radio

▶ Clear Playlist

Save as Playlist

Repeat Off

Shuffle Off

DSP Flat

Profile Content

Settings

2. Press **Up** (↑) or **Down** (↓) to select *Clear Playlist* and press **SELECT**.

All Files

Your Lyra Jukebox is a USB mass storage device that can be used to store any files. To see all of the files that are stored on your Lyra Jukebox:

MUSIC

Artist/Album

Album

Title

Genre

Year

Playlists

▶ All Files

Radio Recordings

1. Highlight *All Files* (press the **Up** (^) or **Down** (v) arrow button) from the *Music* menu.

ALL FILES

▶ Folder 1

Folder 2

Folder 3

Song 1

Song 2

2. Press **Enter / Next** (>) (the *All Files* menu appears). Folders are listed first and individual files are listed next.

Note: *The folders and files are sorted in the order they were transferred to the Lyra Jukebox (the folder you transferred most recently appears last in the list of folders and the file you transferred most recently would be the last on the list since file names follow folder names.*



Additional Features

MENU	
▶ Go to Radio	
Clear Playlist	
Save as Playlist	
Repeat	One
Shuffle	Off
DSP	Flat
Profile Contents	
Settings	
System Info	

Press **MENU** to access music sub-menu.

Repeat

Three repeat options are available on the Lyra Jukebox.

- *Repeat Off* - No repeat option selected.
- *Repeat One* - Plays the current song repeatedly. The repeat one icon  will show on the display.
- *Repeat All* - Plays all songs in the current view repeatedly. The repeat all icon  will show on the display.

MENU	
Go to Radio	
Clear Playlist	
Save as Playlist	
▶ Repeat	One
Shuffle	Off
DSP	Flat
Profile Contents	
Settings	
System Info	

1. From the music sub-menu, highlight Repeat. (Press the **Up** (^) or **Down** (v) button).
2. Press **SELECT** to toggle and select repeat options.
The corresponding repeat icon appears on the display.

3. Press the **Back / Previous (<)** button or the **MENU / Lock (⏻)** button to return to the main Menu.

4. Select the item you wish to play and press the **Play / Pause (▶ ||)**.

If Repeat All is activated, the songs in the folder where playback begins will be repeated

If Repeat One is activated, the selected song where playback begins will be repeated.

5. To de-select the repeat option, repeat steps 1 and 2 and select *Repeat Off*.

Shuffle

When Shuffle is On, songs are played in random order.

If shuffle is activated, the songs in the view where playback begins are played randomly. After all the songs have been played, the unit will randomly select another folder and shuffle all the songs in the newly selected folder.

MENU	
Go to Radio	
Clear Playlist	
Save as Playlist	
Repeat	One
▶ Shuffle	Off
DSP	Flat
Profile Contents	
Settings	
System Info	

1. From the music sub-menu, highlight *Shuffle* (Press the **Up (^)** or **Down (v)** button).

2. Press the **SELECT** button repeatedly to toggle between Shuffle on and off.

The Shuffle  icon will show on the display when shuffle is on.

3. Use the **Back / Previous (<)** button or the **MENU / Lock ()** button to return to the main menu.

4. Use the Navigation buttons to select the folder where you want shuffle playback to begin.

Press **Play / Pause (▶ ||)** to begin playback.

All songs/folders in the folder where playback begins will be played randomly.

5. To de-select the shuffle option, repeat steps 1 and 2 to select *Shuffle Off*.

Adjusting DSP Settings

DSP Settings (Digital Signal Processor settings) adjust the various levels of the audio output for different types of songs. For example, the DSP setting for BASS makes the bass sounds more prominent. You can also personalize the levels via the *Graphic EQ* menu item. The default DSP setting for your Lyra Jukebox is *FLAT*.

MENU	
Go to Radio	
Clear Playlist	
Save as Playlist	
Repeat	One
▶ Shuffle	Off
DSP	Flat
Profile Contents	
Settings	
System Info	

1. From the music sub-menu, select *DSP* using the **Up (^)** or **Down (v)** button.
2. Press **SELECT** to toggle and select the DSP setting you want to use.
 - FLAT
 - BASS
 - ROCK
 - POP
 - JAZZ
 - Graphic EQ

Personalizing DSP Output (Graphic EQ menu item)

Graphic EQ: enables you to personalize audio output settings.

DSP	
Flat	
Bass	
Rock	
Pop	
Jazz	
▶ Graphic EQ	

1. From the music sub-menu, select *DSP* using the **Up (^)** or **Down (v)** button.
2. Press **Enter / NEXT (>)** to show a list of DSP options.
3. Select *Graphic EQ* using the **Up (^)** or **Down (v)** button.

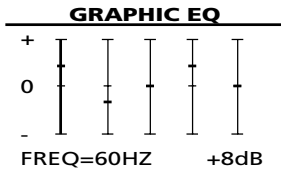

4. Press **Enter / Next (>)** to show the *Graphic EQ* display.
5. Press **Enter / Next (>)** to move among frequency adjustments (60Hz, 250Hz, 1kHz, 4kHz and 12 kHz).

Press the **Up (^)** or **Down (v)** button to adjust levels between +15 and -15.

6. Press the **Back / Previous (<)** button to return to the previous menu or the **MENU / Lock (⏏)** button to return to the main *Music* menu.

Profiler

The application will profile and sort supported audio files on your Lyra Jukebox so you can sort and play them properly.

Note: *It is best to profile your contents on your PC after each transfer of music files. Profiling on the unit will take longer and may use up battery power.*



Note: *Approximately 3500 songs can be profiled on the Lyra Jukebox. If the number of audio files exceed this limit, use your PC for profiling (Refer to page 25).*

MENU	
Go to Radio	
Clear Playlist	
Save as Playlist	
Repeat	One
Shuffle	Off
DSP	Flat
▶ Profile Contents	
Settings	
System Info	

1. Highlight *Profile Contents* from the music sub-menu. (Use the **Up (^)** or **Down (v)** button).
2. Press **SELECT** to start profiling contents on the Lyra Jukebox or press **Back / Previous (<)** to cancel and return to the previous menu level.

Selecting Radio Mode

MENU

- ▶ Go to Radio
 - Clear Playlist
 - Save as Playlist
 - Repeat Off
 - Shuffle Off
 - DSP Flat
 - Profile Contents
 - Settings
 - System Info
1. If the unit is in music mode, press the **MENU / Lock** () button to view the music sub-menu.
 2. Use the **Up** () or **Down** () button to select *Go to Radio* and press **SELECT** for radio mode.

Preset Station

Press the **PLAY / PAUSE** () button to select between Preset mode and Tune mode.



Tuning to a Station

RADIO

FM 106.1 MHz

Manual

Stereo

- Press the **Back / Previous** () arrow button to tune down radio frequency.
- Press the **Enter / Next** () arrow button to tune up radio frequency.

Setting Preset

RADIO

FM 106.1 MHz

Manual Stereo

SAVE AS PRESET

Save FM 106M.1 MHz as

Preset: 1

Name:

SAVE AS PRESET

Save FM 106.1 MHz as

Preset: 1

Name:

SAVE AS PRESET

Save FM 106.1 MHz as

Preset: 1

Name: KMEL Hip-Hop

RADIO

FM 106.1 MHz

Preset 1

KMEL Hip-Hop

Preset Stereo

1. Tune to the station to be saved as a preset station.

2. Press **SELECT**.

3. Press the **Up (^)** or **Down (v)** arrow button to select a preset location

4. Press **SELECT**.

5. Create a name for the preset location using the **Up (^)** or **Down (v)** arrow button to select an alphabet or number.

Press **Back / Previous (<)** to move the cursor to the left.

Press **Enter / Next (>)** to move the cursor to the right.

6. Press **SELECT** to confirm your selection.

Selecting Preset Station

In preset mode, press **Back / Previous (<)** to select the previous preset station and press **Enter / Next (>)** to select the next preset station.

Clearing Preset

MENU	
Go to Music	
▶ Clear Preset	
Mode	Stereo
RecDur	30min
RecQua	High
Settings	
System Info	

CLEAR PRESET	
Clear preset <u>5</u> ?	

Change Preset: ▲ / ▼
Confirm: SELECT
Cancel: ◀

1. In radio mode, press **MENU/ Lock (🔒)** to view radio sub-menu.
2. Use the **Up (^)** or **Down (v)** arrow button to select *Clear Preset*.
3. Press the **Enter / Next (>)** button or the **SELECT** button.
4. Press the **Up (^)** or **Down (v)** arrow buttons to select the preset location to clear.
5. Press **SELECT** to confirm.

Suppressing Stereo Signal

MENU	
Go to Music	
Clear Preset	
▶ Mode	Stereo
RecDur	30min
RecQua	High
Settings	
System Info	

1. From the radio submenu, use the **Up (^)** or **Down (v)** arrow buttons to select *Mode*.
2. Press **SELECT** to select between Stereo and Mono sound.

Record FM Radio

RADIO
FM 106.1 MHz
Preset 1
KMEI Hip-Hop
Preset Stereo

1. Tune to the Station to be recorded by following steps under "Tune to a Station" or "Selecting Preset Station".

RECORD RADIO
Recording...
00:55:34
FM 106.1MHz

2. Press **FM REC** to start recording.

RECORD RADIO
Paused...
00:55:34
FM 106.1MHz

Press **FM REC** to pause recording. Press again to resume.

RECORD RADIO
Recording as:
FM106.1 [001].mp3

3. Press **OFF / STOP (■)** to stop recording.

Selecting Recording Duration

MENU	
Go to Music	
Clear Preset	
Mode	Stereo
▶ RecDur	30min
RecQua	High
Settings	
System Info	

1. From the radio sub-menu, use the **Up** (^) or **Down** (v) arrow button to select *RecDur*.
2. Press the **SELECT** button to select among 30min, 60min, 90min, 120min and Max.

Selecting Recording Quality

MENU	
Go to Music	
Clear Preset	
Mode	Stereo
RecDur	30min
▶ RecQua	High
Settings	
System Info	

1. From the radio sub-menu, press the **Up** (^) or **Down** (v) arrow button to select *RecQua*.
2. Press the **SELECT** button to select between Standard (48k), High (96k) and Max (128k).

View FM Recording

MUSIC	
Artist	
Artist/Album	
Album	
Title	
Genre	
Year	
Playlists	
All Files	
▶ Radio Recordings	

1. From the main Music menu, use the **Up** (^) or **Down** (v) arrow button to select *Radio Recordings*.

RADIO RECS	
▶ ♪ FM87.5 [001]	
♪ FM106.1 [001]	
♪ FM106.1 [002]	
♪ FM102.5 [001]	
♪ FM106.1 [003]	

2. Press the **Enter / Next** (>) arrow button to view the list of radio recordings in the order they were recorded.

Delete FM Recording

RADIO RECS

- ♪ FM87.5 [001]
- ▶ ♪ FM106.1 [001]
- ♪ FM106.1 [002]
- ♪ FM102.5 [001]
- ♪ FM106.1 [003]

MENU

- Go to Radio
- ▶ Clear / Delete
- Repeat Off
- Shuffle Off
- DSP Flat
- Profile Contents
- Settings
- System Info

DELETE

After deleting,
please profile
contents!

Please confirm !

[<] : Cancel

[SELECT] : Delete

1. With the arrow at the radio recording to be deleted, press the **MENU / Lock** () button to view the radio sub-menu.
2. Use the **Up** (^) or **Down** (v) arrow button to select *Clear / Delete*.
3. Press the **SELECT** button.
4. Press **Back / Previous** (<) to cancel or **SELECT** to confirm and delete selected radio recording.

System Settings

You can personalize the display settings for your Lyra Jukebox.

1. Press **MENU** to view music or radio sub-menus.
2. From the sub-menu, use the **Up (^)** or **Down (v)** arrow button to select *Settings*.

Music Menu	
MENU	
Go to Radio	
Repeat	Off
Shuffle	Off
DSP	Flat
Profile Contents	
▶ Settings	
System Info	

Radio Menu	
MENU	
Go to Music	
Clear Preset	
Mode	Stereo
RecDur	30min
RecQua	High
▶ Settings	
System Info	

SETTINGS	
▶ Customize Menu	
Contrast	0
Backlight	5sec
PowerSave	min
AutoResume	Off

3. Press the **SELECT** button to show setting options.
4. Highlight the display setting (*Customize Menu, Contrast, Backlight, PowerSave or AutoResume*) you want to adjust using the **Up (^)** or **Down (v)** arrow button.
5. Press **SELECT** repeatedly to select among options in the following settings.
Contrast (between -5 to +5)
Backlight (Off, 5 sec, 10 sec or 30 sec)
PowerSave (30 sec, 1 min, 2 min or 3min)
AutoResume (Off, On)
6. Press the **Back / Previous (<)** button to return to the previous menu or the **MENU** button to return to the sub-menu.

Customize Music Menu

You can set the music menu on the Lyra Jukebox to show and hide certain menu items.

MENU	
Go to Radio	
Repeat	Off
Shuffle	Off
DSP	Flat
Profile Contents	
▶ Settings	
System Info	

SETTINGS	
▶ Customize Menu	
Contrast	0
Backlight	Off
PowerSave	1min
AutoResume	Off

MENU	
Artist	On
Artist/Album	On
▶ Album	Off
Title	On
Genre	On
Year	On

MUSIC	
▶ Artist	
Artist/Album	
Title	
Genre	
Year	
Playlists	
All Files	
Radio Recordings	

- From the Settings menu, select *Customize Menu*. (Press the **Up** (^) or **Down** (v) button).
- Press **Enter / Next** (>) to view *Customize Menu* options.
- Use the **Up** (^) or **Down** (v) button to select the music menu item to hide or show.
Press **SELECT** to toggle between On and OFF.
Select On to show the item on the music menu.
Select Off to hide the item from the music menu.
- Press the **Back / Previous** (<) button to return to the previous menu or the **MENU** button to return to the sub-menu.
Those items that are set to Off will not show on the music menu.

System Info

System Information shows Lyra Jukebox system details which includes the number of songs you have on your Jukebox, the amount of free space available and your firmware version.

SYSTEM INFO

- ▶ No of Song : 4627
- Free Space :1630.54M
- Used Space 2370.46M
- Firmware Info

1. For Lyra Jukebox information, select *System Info* in the music or radio sub-menu using the **Up (^)** or **Down (v)** button.

2. Press **Enter / Next (>)** to show hardware information.

FIRMWARE INFO

3. To see firmware information, select *Firmware Info* and press **Enter / Next (>)**.

4. Press the **Back / Previous (<)** button or the **MENU** button to return to the sub-menu.

Connecting your Thomson Lyra Jukebox to your Car Stereo

The cassette adapter lets you listen to the Lyra in an automobile or RV safely without having to wear headphones.

The car kit is included with your Lyra Jukebox. This accessory kit includes a car cord adapter and a cassette adapter. The car cord adapter lets you power your Lyra from the cigarette lighter socket of a car, truck, or RV. It converts 12-volts to a 5 volt output.

1. Insert the plug on the cassette adapter into the lineout jack on the player. If the headphones are attached, remove them.
2. Insert the cassette (Side A up) into your cassette player making sure the cord is placed in the correct position for your type of player.
3. Remove the cigarette lighter from the socket, and insert the car cord adaptor into the socket.
4. Attach the end of the car cord adapter to the DC IN jack on your Lyra Jukebox (the POWER light comes on).
5. Turn on your Lyra Jukebox, and operate the Lyra Jukebox to play music as described on page 35.
6. Control the volume with the car cassette player.
7. When you're finished,
 - A. Remove the cassette adapter from the car cassette player.
 - B. Turn off the Lyra Jukebox.
 - C. Remove the car cord's plug from the cigarette lighter socket.

Cautions: Make sure to place the cassette securely into the slot with the correct direction for the type of player you have. The car cord adapter is designed to be used only with vehicles having negative ground electrical systems. Use of any other car cord adapter may damage your Lyra Jukebox and void your warranty.

Connecting Your Thomson Lyra Jukebox on your stereo system

Your Lyra Jukebox came with a Line Out Cable that you can use to connect your Lyra to your audio system.

1. Make sure your Lyra Jukebox is off.
2. Connect the black end of the cable to the Headphones jack on your Lyra Jukebox player.
3. Connect the red (audio left) and white (audio right) cables to the corresponding left and right audio jacks on your stereo system.
4. Turn on the power to your audio system, and select the proper input setting on the audio system that corresponds with the way you've connected the Lyra Jukebox to the audio system.
5. Turn on your Lyra Jukebox – press the **ON / Play / Pause (▶ ||)** button.
6. Operate the Lyra Jukebox to play music as described on page 35.

Portable Hard Drive Capability

Since Lyra Jukebox has a 20-gigabyte (PDP2842) or 40-gigabyte (PDP2845) hard drive, you can use it to transport files - any files, not just music files. Some possible uses for this feature are as follows:

- Create back-ups/archive files.
- Connect to other computers - at work, for example.
- Transport digital photo albums.
- Transport files from one computer to another computer. For example, instead of putting files at work on a zip or accessing them on your home computer via e-mail or remote access, you can put the files on your Lyra Jukebox.
- Capture internet downloads.
- Share information.

Check for Updates

Visit <http://www.thomson-lyra.com> for the latest news and firmware upgrades for our Lyra Jukebox. You must update your system after new downloads have been made in order for the new applications to be executed (Refer to page 26).

Tips and Troubleshooting

Problem: Player repeats same tracks or all tracks.

- Repeat play is turned on. Press the MENU button to change the play mode.

Problem: Audio distorted at high volume.

- Select another DSP setting.
- Turn down the volume.

Problem: The audio tracks on my Lyra keep skipping or popping.

- You'll need to re-record the audio track – make sure you close all other applications on your PC when you record.
- Try recording with Error Correction setting turned on.

Problem: Player turns itself off.

- Your Lyra Jukebox turns itself off if you leave it in pause mode or navigation mode for the duration specified in PowerSave.

Problem: Songs aren't listed in any of the sort modes (Artist, Album, etc.)

- The contents of the Lyra Jukebox haven't been profiled (sorted) since the last file transfer. Select the *Profile Device Contents...* menu item from the Lyra Jukebox profiler system tray application on your PC to profile (sort) the contents of the device. The icon in the system tray looks like this .

Problem: Bad or missing file error message displayed on the Lyra Jukebox.

- The Lyra Jukebox system files are corrupted or missing. Select the *Update System Files...* menu item from the Lyra Jukebox profiler system tray application on your PC to update the necessary system files.

Problem: Lyra Jukebox Profiler application icon –  – doesn't appear in the system tray.

- You can restart Windows to auto-launch the application, or you can double-click or run the Lyra Jukebox Profiler executable file that's in the Profiler sub-folder of the installation directory that was specified during the setup process –
(Example Directory:
C:\Program Files\Thomson\Lyra
Jukebox\LyraHDTrayApp\LYRAHD2TrayApp.exe)

If the problem persists, you might need to reinstall the Lyra Jukebox software.

Problem: Lyra Jukebox does not respond to key presses.

- If your Lyra stops responding to key presses, you can reset it by pressing the "OFF" button for about 10 seconds. Most of your settings will be preserved; only the settings that you have changed after your last power off will be lost.



HELPLINE THOMSON

Votre Contact THOMSON : 0 826 820 456
(pour la France 0,15 € / mn)

Ihr Kontakt zu THOMSON: 0180 1000 390, ab 16.10.2000.
(für Deutschland, Kosten zum Ortstarif)

You can contact THOMSON by dialling: 0871 712 1312
(For Great-Britain, all calls will be charged 0,10£ / mn)

Para contactar con THOMSON marque: 901 900 410, a partir del 16.10.2000
(las llamadas serán cargadas al precio de la tarifa local)

Il vostro contatto THOMSON: 8488 10 168, dal 16.10.2000
(tariffa chiamata urbana)

www.thomson-europe.com

FAQ (Frequently Asked Questions)

Question: What is mp3?

mp3 is an abbreviation for MPEG-1, Layer 3 Audio (MPEG = Motion Picture Experts Group). This is a digital sound encoding and compression process that was developed by the Fraunhofer Institut für Integrierte Schaltungen and Thomson. mp3 is an international standard and is well suited for the transfer of high quality audio files over telephone or ISDN lines, and over the internet.

Specifications & System Requirements

Hardware

- Dimensions: 23mm D, 70mm W, 85mm H
- Unit Weight: 146grams
- PDP2842 - 20 Giga Byte Storage
PDP2845 - 40 Giga Byte Storage
- Stereo Headphones Jack
- Mini USB Connection Jack
- Battery Operated: Up to 12 hours of playback with internal rechargeable lithium polymer battery.

Hard Disc

- External Hard Disc Drive: When connected to a computer via USB, the Lyra Hard Disc player is capable of storing any file type allowing the user a fast, convenient method of storing, retrieving, and transferring files. Including word processing files, presentations, spreadsheets and any other computer files.
- Capacity: PDP2842 - 20 GB / PDP2845 - 40 GB
- Rotational Speed: 4200 RPM
- Average Access Time: 12 MS
- Connection: USB 2.0, Hi-speed capable

Software

- Includes Music Management software with the Lyra Jukebox applications and the MusicMatch Jukebox software.

MusicMatch Jukebox software lets the user organize all tracks in a digital music library, create custom playlists through drag and drop interface.

- Encodes mp3, mp3PRO and Windows Media Audio (WMA) files.
- Integrated CD Player.
- Export to WAV
- mp3 Equalizer

Additional Information

PC Hardware Requirements

- Pentium III 500MHz or higher recommended
Macintosh iMac G3 or higher
- Windows @98SE, Me, 2000, or XP
Mac OS X Version 10.1.5 or higher
- Internet Explorer 4.0 or higher
- Internet access
- 100MB free hard disk space for the software
- 64MB RAM (128 MB recommended)
- CD-ROM drive capable of digital audio extraction
- USB port (2.0 recommended)
- Sound card
- 16- bit color video card

Accessories

- CD-ROM Music Management Software
- USB Connection Cable
- AC/DC Adapter
- Clipphone™ Stereo Headphones
- Audio Line-Out Cable
- Car DC Adapter: Supplies power to Lyra Jukebox player from car battery via cigarette lighter plug.
- Car Cassette Audio Output Adapter

Miscellaneous Specifications

- Signal to Noise Ratio (>85dB)
- THD (<0.1%)

1 MusicMatch and MusicMatch Jukebox are registered trademarks of MusicMatch Corp.

2 Warning – This product is not intended for the unauthorized recording or duplication of copyrighted material.

Repair Centers - Hungary

THOMSON SZERVÍZLISTA			
Szervíz	Helység	Cím	Telefon és fax
Major Ferenc e.váll.	Baja	Bara u. 4/D.	79/424-627 T/F
Belka Kft.	Baja	Jelky tér 1.	79/322-333
HIFI-TV-VIDEO	Barcs	Köztársaság u. 7.	(82) 461-680
Infra-Vizió Kft.	Békéscsab	Luther u. 18.	66/441-665 T/F
JUHÁSZ Elektronika	Békéscsab	Kölcsey u. 17.	(66) 324-419
Vidi-Vill Kft.	Budapest	Akácfa u. 6.	1/3229-698T, 3420-530
Kordován Tv. Kft.	Budapest	Kordován tér 2.	1/3806-223T, 3806-965
TV-Video Mester Sz.	Budapest	Rétköz u. 18.	1/2466-000 T/F
SERELCO Szervíz	Budapest	Diószeghy. u. 18.	333-9575, 477-2070,
Camcorder Kft.	Budapest	Budafoki u.35	466-8684, 209-2462/F
Speciál Hírad.Tech.	Budapest	Keleti Károlyu.13	315-0306
SZIGNÁL Szervíz	Dabas	Bem u. 28.	29/362055
Szigi-Vill Bt.	Debrecen	Darabos u. 18.	52/413-406T, 319-810F
CIVIS Kft.	Debrecen	Eötvös u.70	52/555-800
LASSIE Bt.	Diód	Balatoní út 28.	(23) 380-382
MCSB Bt.	Dunaújváros	Petőfi u.2/a	25/287-074 T/F
SZERVÍZ 96 Kft.	Eger	Reményik u. 18.	(36) 313-333
R-NI 98 Bt.	Gyöngyös	Csokonai u. 2.	(37) 500-180
Video-Quadró Kft.	Győr	Lajta u. 2.	96/418-736T, 415-798F
SERELCO	Győr	Nagy i. U.61	96/ 527-517
TRANS-SAT 2000	Nagykanizsa	Csengery u. 33.	(93) 318-416
K.SZ.K. Kft.	Kalocsa	Obermayer tér 7.	(78) 462-480
TV-Video Kft.	Kaposvár	Nádor u. 51.	82/321-526T, 421-526F
KAPOS Énter Kft.	Kaposvár	Zárda u. 18.	(82) 429-306
Electro Record Sz	Kecskemét	Arany J. u. 6.	(76) 484-939
Video-Foton Bt.	Keszthely	Kossuth u. 45.	83/312-867 T/F
Krausz és Tsa.	Kiskunhalas	Táncsics M. u. 6	77/421-972 T/F
Video-Phone Kft.	Kikunfélygh.	Kossuth u.6	76/461 984
ZELKA Rt.	Lenti	Dózsa Gy. út 1.	(92) 351-160
Rádió-Tv. Kft.	Miskolc	Kis-Hunyad u. 52.	46/506-129T, 340-293
Kisjós István e.váll.	Nagykanizsa	Órház u. 4.	93/322-507T, 314-104F
CLANETT Bt.	Nyergesújfal	Diófa u. 15.	(33) 356-633
Mihalkó György	Nyíregyháza	Hősök tere 15/a	42/411-358T, 314-521F
TECHNO-SAT Kft.	Nyíregyháza	Pacsirta u.36	(42) 504-432
MŰSZAKI Bolt	Orosháza		(68) 411-551
Video Klinika	Pápa	Törökbalint u. 7.	89/310-150 T/F
SIGNÁL TV Bt.	Pápa	Eötvös u. 6.	(89) 324-950
T+T TV Szervíz	Pécs	Hungária u. 13.	72/314-044T, 213-941
SERELCO	Pécs	Szabadság u.33	72/212-354
TV-SZER Bt.	Salgótarján	Kassai sor 4.	32/311-750T, 311-021
Javitó Karban	Salgótarján	Úttörők útja 31/A	(32) 310-027
Primvill Kft.	Soltvadkert	Kossuth u.15	78/482-349
Serelco	Szeged	Berlini Krt.6	62/420019
Ekron Bt.	Szekszárd	Rákóczi u. 31.	74/316-723T, 316-864
MIKRO-VIDEO Kkt.	Szekszárd	Kossuth L. u. 3.	(74) 312-214
Motesiczky Pál	Szentendre	Janicsár u. 1.	(26) 313-915
Commission Bt.	Szentes	Kossuth u. 11.	63/313-151 T/F
ELEKTRONIKA	Szentes	Honvéd u. 10.	(63) 400-184
Mega-Mikro Kft	Székesfehérvár	Bátky Zs. U.1	(22) 505-245,246
Videoton Kft	Székesfehérvár	Berényi út. 72-100	22/ 533-680
INFOTECH	Szolnok	Ostor u. 2.	(56) 343-185
Rátel Kft.	Szombathely	Kőszegi u. 2-6.	94/312-345T, 328-919
H & K Elektronika	Szombathely	Puskás Tivadar u 7	(94) 322-203
Elka Kft.	Tatabánya	Komáromi u. 27.	34/316-188,311-777
Pajor & Tsa. Bt.	Vác	Radnóti tér 6	(27) 314-274
Vermes András	Veszprém	Templom u. 3.	88/425-405 T/F
Zsámboki TV. Szer	Vitnyéd	Szent István u. 18.	96/242-395 T/F
ZELKA Rt.	Zalaegerszeg	Mártírok útja 9.	(92) 550-629

Repair Centers - Poland

Miasto	Nazwa firmy	Adres	Tel.Kier	Telefon
Biała Podlaska	SERWIS THOMSON	ul. Chełmońskiego 1	0-83	3420461
Białystok	PPU.H.PERFEKT	ul. Brukowa 7	0-85	7420628
Bielsko-Biała	ELEKTRONIK SERVICE	ul. Legionów 50	0-33	8166065
Bydgoszcz	TV COLOR-SERWIS	ul. B. Zaleskiego 12	0-52	3795597
Bydgoszcz	NOWA TECHNIKA	ul. Kijowska 90	0-52	3424822
Chełm	ZAKŁAD RADIOWO-TELEWIZYJNY	ul. Różana 18	0-82	5633500
Częstochowa	VALVO	Al. Niepodległości 30	0-34	3632868
Elbląg	SERVICE AB - FILIA	ul. Leszno 6	0-55	2362154
Gdańsk	SERVICE AB - FILIA	ul. Grunwaldzka 132	0-58	3413531
Gdynia	SERVICE AB	ul. Indyjska 15	0-58	6218344
Gliwice	FIRMA HANDLOWO-USŁUGOWA	ul. Chorzowska 1	0-32	2315814
Gorzów Wlkp.	UNITRONIX-SERWIS	ul. Stoneczna 3	0-95	7227806
Grudziądz	AUDIO VIDEO THOMSON SERWIS	ul. Pańska 25	0-56	4623228
Jelenia Góra	"FELIX" ZAKŁAD USŁUGOWO-HANDLOWY RTV	Pl. Ratuszowy 5/6	0-75	7523062
Katowice	ELEKTRONIK SERWIS PLUS	ul. Gliwicka 65	0-32	2543560
Katowice	ZAKŁ. USŁUG RTV I AGD	ul. Kujawska 1C	0-32	2589472
Kielce	ELECTRONIC SERVICE	ul. Mickiewicza 10	0-41	3445539
Kielce	MDS ELEKTRONIK	ul. Manifestu Lipcowego 73	0-41	3623926
Konin	SERVICE WMMV	ul. Legionów 23	0-63	2493704
Koszalin	TELSERWIS	ul. Małopolska 1c/3	0-94	3461629
Kraków	MIX-SERWIS	ul. Wadowicka 8A	0-12	2690942
Kraków	ASTEL S.C.	ul. Bałuckiego 9	0-12	2660999
Kraków	ASTEL S.C.	ul. wietokrzyska 10	0-12	6324018
Krasnystaw	ZAKŁAD USŁUG RTV	ul. Poniatowskiego 19	0-82	5763007
Krosno	RAGZ - FILIA	ul. Wojska Polskiego 40	0-13	4362959
Leszno	EURO ELEKTRONIK	ul. Złotnicza 44	0-65	5287323
Lubin	MULTISYSTEM SERWIS	ul. Paderewskiego 10	0-76	8444711
Lublin	UNITRA ELTRON SERWIS	ul. Braci Wieniawskich 5	0-81	7422999
Lublin	DUCAT SERWIS	ul. Choiny 1	0-81	741 30 81
Łódź	W & W	ul. Organizacji "W/N" 52	0-42	6576267
Łódź	W & W	ul. Piotrkowska 235/241	0-42	6370337
Łódź	RAGZ	ul. Piłsudskiego 143	0-42	6763038
Mława	AUTORYZOWANY SERWIS RTV-SAT	ul. Piłsudskiego 42	0-23	6544972
Nowy Sącz	EURO SERWIS	ul. Wiejska 6	0-18	4430335
Nowy Targ	SERWIS RTV i AGD	ul. Szafarska 93d	0-18	2665013
Olsztyn	ZBYSZKO	ul. Galczyńskiego 1/19	0-89	5277566
Opole	SYNCHRO	ul. Sz. Szeregów 23	0-77	4559254
Ostrołęka	TELE AUDIO VIDEO	ul. Bogusławskiego 13	0-29	7643781
Ostrów Wielkopolski	SERWIS RTV	ul. Kompały 3	0-62	7367644
Piaseczno	BWM-ELEKTRONICS - FILIA	ul. Jana Pawła II 24 lok.2	0-22	7368757
Piła	TELS	ul. Ojca M. Kolbe 13	0-67	2126292
Piotrków Tryb.	RAGZ - FILIA	ul. Kostromskiej 24	0-44	6476870
Poznań	NIKU SERWIS	ul. Skłodowa 5	0-61	8523078
Poznań	AKWA ELECTRONIC	ul. Otwocka 8	0-61	8708049
Radom	METRO	ul. Focha 12,pawilon 26	0-48	3634820
Rybnik	ELEKTRONIK SERWIS PLUS - FILIA	ul. Zamkowa 6	0-32	4235413
Rzeszów	VIDEO-SERVICE	ul. Leszczyńskiego 6	0-17	8534668
Siedlce	TOP-SERVICE	ul. Czerwonego Krzyża 14/11	0-25	6339826
Siemianowice Śląskie	KMA ELECTRONICS	ul. Fojkisa 8	0-32	2201400
Sieradz	SOKAL S.C.	Al. Pokoju 11	0-43	8224050
Ślupsk	VIDEOSONIC	ul. Dmowskiego 10	0-59	8455563
Suwałki	TELE-VIDEO SERWIS	ul. Gen. Andersa 7	0-87	5671518
Szczecin	ZURIT SERWIS	ul. Chopina 22	0-91	4525399
Szczecin	PHU HIT-SERVICE	ul. Szwoleżerów 22	0-91	4333741
Tarnobrzeg	SERVIS TV-VIDEO	ul. Wyspiańskiego 9 paw.I	0-15	8221075
Tarnów	TEKIELAND-ELECTRONIC	ul. Kopernika 4	0-14	6223812
Toruń	PHU OMPEX	ul. Hallera 65/3	0-56	6520696
Wałbrzych	NAREL	ul. Mickiewicza 18	0-74	8426216
Warszawa	ASEL	ul. Gen.Abrahama 2b	0-22	6710958
Warszawa	AST	ul.Obozowa 82a	0-22	8361870
Warszawa	BWM-ELEKTRONICS	ul. I. Gandhi 17	0-22	6446156
Warszawa	NOWA TECHNIKA	Pl. Inwalidów 10	0-22	8398379
Warszawa	NOWA TECHNIKA	ul. Białostocka 5	0-22	6185270
Warszawa	NOWA TECHNIKA	ul. Żelazna 58/62	0-22	6243970
Wrocław	FACTRONIK	ul. Wiejska 24	0-54	4118788
Wrocław	THOM-SERWIS	ul. Szczyńska 30	0-71	3277981
Wrocław	SERWIS ELEKTRONICZNY	ul. Hauke-Bossaka 6	0-71	3429296
Zamość	TELERADIOMECHANIKA	ul. Piłsudskiego 31	0-84	6395000
Zielona Góra	JANCOL	ul. Dąbrowskiego 35	0-68	3245137

Wyrób importowany przez

Thomson multimedia Polska Sp. z o.o.

Oddział Consumer Products Marketing & Sales.

Repair Centers - Russia

Страна	Город	Сервисный Центр	Адрес	Телефон
Белоруссия	Минск	ЦТИ	ул. Короля, 26	(017) 2105678, 2893944
Молдавия	Кишинев	ACO-SERVICE-ELECTRON S.R.L.	ул. Банулеску Бодони 45	(373) 222-40-35
Россия	Абакан	Кристалл	ул. Пушкина, д. 54	(39022) 6-85-81, 4-34-21
Россия	Алматьевск	Эль-Мастер	ул. Р. Фахретдина, 24	(85512) 51919
Россия	Архангельск	Двина-Сервис	ул. Урицкого, 54	(8182) 265355
Россия	Балашово	ЧП Дунаев	ул. Н. Леонова, д. 1а Д/К Химиков	(845) 701-233-06
Россия	Балашовка	Кан-Сервис	ул. Калининка, д. 1	(095) 523 3313
Россия	Барнаул	Ремис	ул. Пушкина, 37	(3852) 231241
Россия	Белгород	Видео-Плюс	ул. Богдана Хмельницкого, 86	(0722) 268896
Россия	Березники	ЧП Меркулов	Советский проспект 50	(242) 6-21-21
Россия	Владивосток	Диапазон-Сервис	ул. Балева, 58	(4232) 215287
Россия	Владимир	Ромашка	ул. Горького, 32	(0922) 330798, 331391
Россия	Волгоград	Про-Сервис	ул. Рабоче-Крестьянская, 14	(8442) 445281
Россия	Воронеж	Орбита-Сервис	ул. Донбасская, 1	(0732) 774329, 776625
Россия	Воронеж	Эль-Сервис	Ленинский проспект. 172	(0732) 54-32-91
Россия	Екатеринбург	Сентри	пр-т Космонавтов, 45	(3432) 310336, 32 05 71
Россия	Екатеринбург	Сентри	ул. Ораджоникидзе, 26	(3432) 310336, 32 05 71
Россия	Ижевск	Лэси	ул. Пушкинская, 216	(3412) 438805
Россия	Иркутск	ТИС	ул. 5-ой Армии, 12	(3952) 333859
Россия	Иркутск	ТИС	ул. Партизанская, 149	(3952) 51-31-09
Россия	Июльск-Ола	Эль-Мастер	ул. Советская, 116	(8362) 120912
Россия	Казань	ТВС	ул. Шамали Усманова, 32а	(8432)44-10-51
Россия	Казань	ЭЛЬД/ОРАДО-СЕРВИС	ул. R3orge, д.95	(8432) 685005
Россия	Калининград	Вестер-Сервис	ул. Горького, 50	(0112) 273432, 273150
Россия	Кемерово	Ваид Сервис	ул. Коммунистическая 122	(3842) 258523
Россия	Комсомольск-на-Амуре	Инсайт-Сервис	Мира пр-т. 9	(42172) 4-60 58
Россия	Красноярск	Интернационал Сервис	ул. Вильского, 3	(3912) 453305
Россия	Красноярск	Интернационал Сервис	ул. Караа Маркса, 44	(3912) 453305
Россия	Курск	Экран-Сервис Добролюбова	ул., 17	(0712) 22 33 80, 56 0053
Россия	Липецк	Владон Меркулова	ул., 8	(0742) 41 06 94
Россия	Магадан	Центр-Видео-Сервис	Кольимское шоссе, д. 4	(413-22) 4-11-74
Россия	Магадан	Центр-Видео-Сервис	ул. Караа Маркса, 33/15	(41322) 23322
Россия	Магнитогорск	Эль-Мастер	ул. Ленинградская, 34	(3511) 227878
Россия	Москва	Лавис	Хорошевское шоссе, 33/1	(095) 195 4113, 195 2593
Россия	Москва	Интеррадиоприбор	проспект завода "Серп и молот", 5	(095) 3614933, 2733173
Россия	Москва	Интеррадиоприбор	ул. Мневники, 7 корп. 2	(095) 946 4604, 946 4504
Россия	Москва	КАС - Технический центр	Шелыгинская наб., 18	(095) 7973434
Россия	Москва	Лит-Сервис	Жуевинский б-р. 9	(095)705-4688, 705-0899
Россия	Москва	Лит-Сервис	б-р Дмитрия Донского, 2а	(095)711-8336, 7111-5827
Россия	Москва	Лит-Сервис	ул. Братиславская, 14	(095)346-8744
Россия	Москва	Лит-Сервис	ул. Краснобогатырская 75	(095)269-2310, 966-3511
Россия	Москва	Мир и Сервис	Пролетарский пр. 23	(095) 3250305, 3253437
Россия	Москва	Партия-Сервис	ул. Академика Королева, д. 5	913-33-88
Россия	Москва	Партия-Сервис	ул. Викторенко, д. 3	742-50-20
Россия	Москва	Партия-Сервис	ул. Исаковского, д. 33, корп. 4	757-50-00, 758-40-51
Россия	Москва	Партия-Сервис	ул. Марксистская, д. 34	912-00-08, 911-67-80, 911-68-89/73
Россия	Москва	Партия-Сервис	ул. Народног Ополчения, д. 22, корп 2	787-70-21
Россия	Москва	Партия-Сервис	ул. Новопеределкинская, д. 9А	731-11-00
Россия	Москва	Партия-Сервис	ул. Обручева 30	(095) 9133939
Россия	Москва	Партия-Сервис	ул. Уральская, д. 1а	462-0041
Россия	Москва	Партия-Сервис	ул. Ярцевская, д. 30	149-23-31, 149-24-19
Россия	Москва	Экс-Сервис	ул. Врубеля, д. 12	(095)742-9081
Россия	Москва	Эль-Мастер	ул. Кулакова, д. 20	(095) 7547007
Россия	Мурманск	СРС Мурманск	ул. Софьи Перовской, 37	(8152) 458701, 05 49 49
Россия	Н. Новгород	Электроника	ул. Амкеевская, 9	(8312) 19-41-08, 19-41-10
Россия	Н. Новгород	Электроника	ул. Лескова, 8	(8312) 59-46-20, 54-68-18
Россия	Набережные Челны	РАФТ	Новый Город, 28/08	(8552) 549823
Россия	Нефтеюганск	Эфир	13 микрорайон, 56	(34612) 54223
Россия	Новгород	ТКТ (Орбита)	ул. Кочетова 23а	(81622) 611200
Россия	Новокузнецк	Стратас	ул. Транспортная 49а	(3843) 78-71-95
Россия	Новосибирск	ЭЛЬ-СЕРВИС	ул. I-я Бельцова, д. I	(3832) 285246
Россия	Новосибирск	Юса	Красный пр-т. 50	(3832) 180995, 181755
Россия	Омск	Телеконт-Сервис	пр-т Маркса, 18	(3812) 312530
Россия	Оренбург	Коминком	Брестская ул. 7	(3532) 626888, 627701
Россия	Орск	Коминком	Школьная ул. 13	(35372) 62631

Additional Information

Repair Centers - Russia

Страна	Город	Сервисный Центр	Адрес	Телефон
Россия	Пенза	ПТС	Московская ул., 18	(8412)662222
Россия	Пермь	ЛЭБТ	Бульвар Гагарина, 58а	(3422) 617900, 619480
Россия	Пермь	ЭЛЬДОРАДО-СЕРВИС	Б-р Багарина, д.32	(3422) 484477
Россия	Петрозаводск	ЛАНС	наб. Ла-Рошель, 17	(8142) 765150
Россия	Петропавловск-Камчатский	Мастерская №1	ул. Ключевская, 56, каб. 203	415-37-6-37
Россия	Ростов-на-Дону	ААА-Сервис	ул. Горького 136	(8632) 907900
Россия	Ростов-на-Дону	ЭЛБСЕРВИС	ул. Красноармейская, д.206	(8632) 618066
Россия	Рязань	Фонограф	пл. 50-летия Октября, д.1	(0912) 721712
Россия	Самара	СЕРВИС-ЦЕНТР	ул. Республиканская, д.62	(8462) 538199
Россия	Самара	Энон-Сервис	ул. Советской Армии, 148	(8462) 240740
Россия	Саранск	Видео-Сервис	ул.В.Терешковой 18а	(834-22)46-54-85
Россия	Саратов	Смарт	пр-т 50 лет Октября, 110а	(845-2) 48-41-31,32-09-11,34-00-39
Россия	Сергиев Посад	Эль-Мастер	пр-т Красной Армии, 4	(09654) 60533
Россия	Сочи	Союз-Сервис	ул. Московская, 5	(8622) 920225
Россия	Ст.-Петербург	Орбис	Витебский пр-т 33 кор.2	(812) 379-5655
Россия	Ст.-Петербург	Орбис	Ланское шоссе 65	(812) 246-3793
Россия	Ст.-Петербург	Орбис	Октябрьская наб. 60	(812) 446-6171
Россия	Стерлитамак	Импорт - Сервис	ул. Коммунистическая, 61	(3473) 24 42 85
Россия	Тверь	Губой Экран	пр. Победы, 2/2	(0822) 36 05 20
Россия	Тольятти	Мастер-Класс	ул. Карбышева, 6	(8482) 260595, 260065
Россия	Томск	Командор-Сервис	ул. Беленца, 14	(3822) 516-333
Россия	Тулза	Омегамет	ул. Доватора, 1	(0872) 436158, 462466
Россия	Тюмень	Тюмень Импорт-Сервис	ул. Малыгинайте, 97	(3452) 224596, 22 45 96
Россия	Тюмень	Тюмень Трейд	ул. Перцева, д.101	(3452) 46-41-06
Россия	Улан-Уде	МВ-Маркет	Гостинные ряды "МВ-Маркет"	(3012) 211661
Россия	Усурийск	Вега-Ирант	ул. Советская, 29	(42341) 21035
Россия	Усть-Илимск	Питон Офис 4,	ул. Ментателей д. 21	(39535) 57147
Россия	Уфа	Техно	ул. Чернышевского, 88	(3472) 377303, 377344
Россия	Уфа	ЭЛЬДОРАДО-ЛЕНД	ул. Чернышевского, д.100	(3472) 222448
Россия	Челябинск	Импорт-Сервис	ул. Энтузиастов, 16	(3512) 340505
Россия	Челябинск	ЭЛБ-СЕРВИС	ул. Володарского, 32	(3512) 65-31-09
Россия	Энгельс	ЭПКСЦ "Ирант"	ул.Петровского,57	(845-11)46-42-37
Украина	Винница	СКОРПАГ-СЕРВИС	пр-т Юности, 16, к. 104	(0432) 46-43-93
Украина	Днепропетровск	НПТ	ул. Ленина, 21а	(0562) 37-13-60
Украина	Днепропетровск	СЕРВИСЦЕНТР	пл. Октябрьская, 2, офис 6.	(0562) 377-38-30
Украина	Донецк	Импорт-Сервис	пр-т Мира, 13	(062) 335-06-70
Украина	Житомир	ВЫБОР	ул. Победы, 32	(0412) 41-88-26
Украина	Запорожье	ТТП-94	ул.Грязнова, 71	(0612) 13-80-49
Украина	Ивано-Франковск	ООО "Мегастайл"	ул. Вовчиныцяк, 172а	(03422) 6-15-30
Украина	Киев	Крок ТТЦ	пр-т Владимира Маяковского, 26	(044) 5450897
Украина	Кировоград	ДП "Инэк-Кировоград"	пр-т Коммунистический, 22/12	(0522) 22-06-21
Украина	Краматорск	Астрон	ул.Дворцовая, 6	(0626) 41-97-34
Украина	Кременчуг	ИНЭК-КРЕМЕНЬ	ул. Победы, 17/6	(05366) 3-11-21
Украина	Кривой Рог	ДОМТЕХСЕРВИС	ул. Волгоградская, 4	(0564) 74-36-15
Украина	Луганск	КОРСАК	ул. Кошобинского, 27	(0642) 34-56-06
Украина	Львов	ООО "Каскад-Интерк"	ул. Гулая Артемовского, 15а	(0332) 77-59-55
Украина	Львов	МАРКЕТ-ЛЬВОВ	ул. Сторомонко, 12	(0322) 33-70-63
Украина	Мариуполь	ООО "Нейтрон"	пр-т Металургов, 94	(0629) 529282
Украина	Николаев	СЦА/ЛАДИН	ул. Никольская, 46	(0512) 47-04-96
Украина	Николаев	ЧП Осипенко (Транзит)	пр. Ленина, 184	(0512) 57-52-35
Украина	Одесса	Профессионал	ул.Успенская д.24/26	(0482) 42-91-52
Украина	Одесса	ЮС СЕРВИС	ул. Лейтенанта Шмидта, 21	(0482) 37-54-66
Украина	Полтава	НПО "Промэлектроника"	ул.Фрунзе, 66	(05322) 7-81-55
Украина	Ровно	ОПЛА	ул. С. Бандеры, 55	(0362) 62-04-01
Украина	Севастополь	ПАНОРАМА-С	ул. Генерала Петрова, 3 офис 1	(0692) 45-39-00
Украина	Севастополь	Северодонецк радиотехника	ул. Маяковского, 13	(06452) 4-30-30
Украина	Симферополь	ГАРАНТ	ул. Павленко, 54	(0652) 52-15-98
Украина	Сумы	СЕРВИСЦЕНТР	ул. Героев Сталинграда, 3	(0542) 21-06-79
Украина	Тернополь	ТЕРНАВА-СЕРВИС	ул.Зурик, 39	(0352) 43-30-22
Украина	Ужгород	ПРОФИ-СЕРВИС	пл. Ш.Петевич, 47	(0312) 23-44-63
Украина	Харьков	БЕСТ	ул. Полявский Шлях, 30	(0572) 12-38-60
Украина	Херсон	РАДИО	ул. Советская, 23	(0552) 22-57-30
Украина	Черкассы	ЕВРАЗИЯ-С	ул. Одесская, 8	(0472) 66-36-53
Украина	Чернигов	ЛАГРОС LTD	пр-т Мира, 80	(0462) 17-78-99
Украина	Черновцы	ЗАМЕКС-Плюс	ул. Русская, 198	(03722) 6-09-23
Украина	Ялта	Ави-Электроникс	ул.Жадановского, 3	(0654) 38-60-18

Repair Centers - Czech Republic

Seznam servisních partnerů - Česká republika				
Servisní partner	Město	Ulice	Telefon	PSČ
Prague				
NOVOTNÝ elektronik	Praha 4	Hvězdoslavova 1599	272 937 184, 272 942 516	
NOVOTNÝ elektronik	Praha 8	Zenklova 81	283 840 523, 284 840 158	
NOVOTNÝ elektronik	Praha 6 - Řepy	Makovského 1144	235.321.277	
NOVOTNÝ elektronik	Praha 4 - Chodov	Hráského 1909	271.913.629	
NOVOTNÝ elektronik	Vlašim	Poděbradova 358	317.844.844	
BELS CZ s.r.o. - Praha	Praha 4	Bělehradská 18	261.218.480	
DI servis	Praha 8	Pernerova 35	221 897 233-5	
AV Kovoslužba	Praha 4	Cilkova 9/796	241.714.442	
Central Bohemia				
BELS CZ s.r.o. - Benešov	Benešov	Zapova 525	317.725.060	
TV-VIDEO centrum	Nymburk	Palackého 119	325.514.891	
ELECTRONIC SERVICE NOVÁK	Příbram	Prokopská 4	318.625.052	
East Bohemia				
Jozef Ondruš - Radiotechnika	Pardubice	Tepleho 1398	466.303.951	
Jozef Ondruš - Radiotechnika	Hradec Kralové	Nerudova155	495.530.073	
West Bohemia				
NELIN spol. s r.o.	Karlovy Vary	Krymská 47	353.222.028	
Televizní servis Ladislav Juppá	Plzeň	Lobezská 62	377 456 356, 377 443 545	
TOP Elektronik	Karlovy Vary	Moskevská 64	353224056, 353 230 337	
North Bohemia				
Horák electronics s.r.o.	Jablonec n. Nisou	Sadova 8	483.312.550	
Jiří Suchý servis video - televize	Česká Lípa	Kolarova 2059	487.832.064	
Jan Murga MJ electronic - Stráž nad Nisou	Stráž nad Nisou	Myslbekova	485.159.301	
Jan Murga MJ electronic - Liberec	Liberec	Na Perstyně 378/42	485.104.628	
RAMI Elektronik	Ústí n. Labem	Novosedlické nám. 1239/2	47 55 33 166	
TV servis - Vítek Lubomír	Chomutov	Kadanská 3259/3	474.629.223	
TV*VIDEO*SAT - V.Bloudek	Most	Moskevská 1/14	476.206.709	
VIDCOM ELEKTRONIK	Teplíce - Prosetice	Plynarenská 280	417.531.555	
South Bohemia				
ELEKTRO STELA	Tábor	Údolní 2908	381.256.600	
ELEKTRO STELA	Mašice	Táborská 200	381.277.304	
Milan Cepel - ELEKTRONIKA	Humpolec	Rasínova 466	565 532 363, 565 532 021	
Video TV servis	České Budějovice	Na zlaté stoce 14	385.310.165	
VOBUKO spol. s r.o.	Písek	Havlickovo nám. 92	382 215 356, 382 219 130	
South Moravia				
KNK servis	Brno	Bubeníčková 12/14	548 210 713, 548 213 870	
TEVIS BRNO s.r.o.	Brno	Blatného 2	541 340 003, 541 211 112 i fax	
Miroslav Drda - TELES RTS	Otrokovice	Olbachtova 1621	577.922.677	
VIKI spol. s r.o.	Jihlava	Fritcova 12	567.303.546	
Rates s.r.o.	Hodonín	Havlíčková 2	518.341.300	
Belvis elektronika	Uherský Brod	Dlní valy 507	572.633.417	
North Moravia				
TELEVIZEVIDEO SERVIS	Ostrava - Poruba	U oblouku 501/5	596.912.602	
KATEX s.r.o.	Šumperk	Nam. Republiky 8	583.212.807	
MONTAN RTS s.r.o.	Olomouc	Sokolská 8	585.220.312	
MONTAN RTS s.r.o.	Dolany 376	Dolany 376	585.396.512	
SOPRA s.r.o.	Opava	Komárovská 2	553 711 395, 553 620 207	

ИНФОРМАЦИЯ ДЛЯ ПОТРЕБИТЕЛЯ

Наименование продукции	Lyra Jukebox
Наименование и адрес изготовителя:	THOMSON 46 quai Alphonse Le Gallo 92648 Boulogne France
Наименование и адрес завода изготовителя:	Jiaoyitang, Tangxia Town, Dongguan City, Guangdong Province, P.R.C.
Правила и условия хранения, транспортирования, эффективного использования, основные потребительские свойства и характеристики	См. инструкцию по эксплуатации
Информация о сертификации продукции	Товар сертифицирован. Подробные сведения и копию сертификата (ов) соответствия Вы можете получить по месту приобретения товара.
Срок службы	2 (два) года
Срок гарантии	1 (один) год

visit us at www.thomson-europe.com or www.thomson-lyra.com

Please do not send any products to the address listed in this manual or on the carton. This will only add delays in service for your product.

THOMSON
46, quai Alphonse Le Gallo
92648 Boulogne Cedex
FRANCE
5594468B (EN)

Free Manuals Download Website

<http://myh66.com>

<http://usermanuals.us>

<http://www.somanuals.com>

<http://www.4manuals.cc>

<http://www.manual-lib.com>

<http://www.404manual.com>

<http://www.luxmanual.com>

<http://aubethermostatmanual.com>

Golf course search by state

<http://golfingnear.com>

Email search by domain

<http://emailbydomain.com>

Auto manuals search

<http://auto.somanuals.com>

TV manuals search

<http://tv.somanuals.com>