

Chapter 1: Getting started

Important information	2
Safety	2
Care	2
Specific precautions for DLP™ TV sets	3
What is DLP™ technology?.....	3
Switching your TV set on and off	3
Replacing the lamp	3
Moving the TV set.....	3
Remote control	4
Using the remote control for other equipment	4
Programming the remote control.....	4
🔊 Programming the volume control function	5
🔊 The Learning feature	6
Switching on	7

Chapter 2: Channel set-up

Initial set-up	8
Manual channel set-up	9

Chapter 3: General operation

Switching the TV set on and off	10
Volume	10
Displaying status information	10
Accessing channels	10
Accessing AV programmes	10
🔊 Demo mode	11
Zoom	11
List of programmes	11
Freezing a picture	11
Flat batteries	11

Chapter 4: Advanced functions

Adjusting the sound	12
Configuring the sound settings	12
🔊 Headphone settings	12
Graphic equaliser	13
Adjusting the picture	13
Advanced use	14
Lamp & Position	14
Setting the time	15
Setting the time.....	15
Programming the sleep timer	15
Programming the wake-up timer	15
Parental control	16
Accessing the Parental control menu	16
Locking the buttons on the front of the TV set	16
Locking a channel or AV programme	16
Operation (TV mode)	16
🔊 Picture in Picture (PIP)	17
Operation (TV mode)	17
Customising your television	18
Preferences.....	18
Configuring AV sockets	19
Teletext	20
Accessing Teletext.....	20
Navigator	20
Other Teletext functions.....	21
Program Info	22
Defining search criteria	22
Recording a programme	22
Storing a programme.....	22
Checking your selections in the Review screen	23

Chapter 5: Other information

Removing the front panel piece	24
Sockets	24
🔊 Connecting headphones	25
Connecting active speakers	25
Connecting an amplifier	25
Connecting a video recorder	25
About NexTVView Link	26

This manual applies to several TV set models. Some features may not be available on the model you purchased.

🔊 This symbol indicates optional functions.

The model number of your TV set is on a label at the back of the set and on the cover of this manual.



This publication is printed on recycled paper.

Important information

Safety

- Ensure that your domestic mains supply voltage matches the voltage indicated on the identification sticker located at the back of your set.
- The TV set's components are sensitive to heat. The **maximum ambient temperature** should not exceed **35° Celsius**. Do not cover the vents at the back or sides of the TV set. Leave sufficient space around it to allow adequate ventilation.
- **Moisture** in rooms where the set is installed should not exceed **85% humidity**. If you have to use the TV set outdoors, **do not expose it to rain or splashing water**. Moving the set from a cold place to a warm one can cause condensation on the screen (and on some components inside the TV set). Let the condensation evaporate before switching the TV set on again.
- If you intend to be **away for a long period**, switch the TV set off at the on/off switch ①. Even when off, some components remain in contact with the mains electricity supply. To completely isolate the set you must remove the plug from the mains supply socket.
- During **thunderstorms**, we recommend that you disconnect the TV set from the mains and aerial so that it is not affected by electrical or electromagnetic surges that could damage it. For this reason, keep the **mains and aerial sockets** accessible so they can be **disconnected**, if necessary.
- **Unplug** the TV set immediately if you notice it giving off a **burning smell** or **smoke**. You must never, under any circumstances, open the TV set yourself, as you run the risk of an **electric shock** in doing so.
- Your TV set includes a high-performance electronic protection system to prevent damage by external influences, such as ESD (Electrostatic Discharge) or pollution on the mains power supply (Mains Transients). In the event of such external pollution, your TV set may shut down automatically, and you may need to switch it back on again using the remote control or the on/off switch ① located under the front panel.
- Work carried out by **unqualified persons** or modifications to the high voltage may cause hazard. A set modified in this way no longer meets the original specifications and should not be switched on again.

THOMSON disclaims any liability if the TV set is not used in accordance with this manual.

Care

- Use a glass-cleaning product to clean the screen and a soft cloth and mild detergent to clean the rest of the set.
- Dust the vents at the back and sides regularly. Using solvents, abrasive or alcohol-based products could damage the TV set.

 HELPLINE **THOMSON**

You can contact THOMSON by dialling: **0871 712 1312**
(for United Kingdom, £0.10/mn inc VAT)

www.thomson-europe.com

In the interest of improving the quality of our products, we reserve the right to modify their features. The information in this manual is, therefore, subject to change and does not represent any kind of contract.

Specific precautions for DLP™ TV sets



What is DLP™ technology?

You have just bought a TV set equipped with DLP™ (Digital Light Processing) technology. This new technology uses a special lamp, a colour wheel and an optical semi-conductor comprising a huge number of microscopic mirrors to provide you with exceptional picture quality in a thin, lightweight design.

To ensure that you can enjoy your TV set's unparalleled operation for as long as possible, you should observe the following precautions.

Switching your TV set on and off

As with all projection devices, your TV set contains a special lamp which must heat up and cool down in the proper manner to ensure its optimum operation for as long as possible. To prolong the life of the lamp, you must observe the required heating up and cooling down times.

- To switch the TV set on, press the on/off button under the front panel of the set. The picture takes up to 40 seconds to display. If no picture is displayed after 2 minutes, it is possible that the lamp needs to be replaced (see further below).
- To put the TV set in standby mode, press the  button on the remote control. When the set is in standby mode, the indicator on the front is **red**.
To switch off the TV set, press the  button under the front panel of the set.

The fan continues to run for about another two minutes to cool the lamp down.

Important: NEVER unplug the set when the fan is running.

Replacing the lamp

The lamp supplied with the TV set has a lamp life of a few thousand hours in normal operating conditions.

- If you notice the following changes:
 - The time the TV set takes to come on gets noticeably longer.
 - The picture's brightness decreases.
 - When you switch the set on, there is sound and you can change channels, but no picture is displayed and the indicator on the front starts flashing red. This occurs several times.

This means that the lamp's power is running down. You then need to buy a new one.

- When you switch the TV set on, if no picture is displayed after 2 minutes, the lamp needs to be replaced.

Choose the exact same type and follow the instructions provided in the "Lamp replacement instructions" leaflet (the right lamp type is indicated in the help text for the **Lamp brightness** option in the **Lamp & Position** menu, see page 14).

Important:

- NEVER touch the lamp with your fingers because any grease deposits left on it can reduce the lamp's life. Always use some kind of cloth to handle the lamp (gloves, duster, etc.).
- Even after the fan has stopped, the lamp's temperature still remains very hot for about 60 minutes and can cause burns.

Moving the TV set

To avoid any damage to the lamp, you should not move the TV set while the lamp is still hot. Wait until the fan stops before moving it.

Digital Light Processing and DLP are trademarks of Texas Instruments.

Manufactured under license from Dolby Laboratories.













"Dolby", "Pro Logic", and the double-D symbol are trademarks of Dolby Laboratories.







TruSurroundXT, SRS and  symbol are trademarks of SRS Labs, Inc.
TruSurroundXT technology is incorporated under license from SRS Labs, Inc.

Getting started

Remote control

Most of your television's functions are available via the menus that appear on the screen. The remote control supplied with your set can be used to navigate through the menus and to configure all the general settings. The remote control and its functions may vary depending on the television model. The rest of this page contains the description of the most comprehensive remote control. Optional remote control features are indicated by the symbol .

	Standby / quit standby.
TV	To access TV mode. Press this button to control the television.
VCR	To access VCR mode.
DVD	To access DVD mode.
 SAT	To access SAT mode.
 AUX	To access AUX mode.
 AMP	To access AMP mode.
 light	To provide information: - it lights up when you press a button, - it indicates the status when the remote control is being programmed (see page 5), - if the batteries are run down, it flashes when you press a button.
 PIP	To enable the PIP function.
 SWAP	To swap the main picture with the PIP picture.
 PIP+/PIP-	To change programmes within the PIP function.
 ZOOM	To change the size of the PIP picture.
 FREEZE	To freeze the main picture.
 SLEEP	To access directly the Sleep timer option in the Time menu.
 LIGHT	Remote control light.
PRESETS	(red button) sound and picture settings menu
LIST	(green button) list of programmes

INFO	(yellow button) status information
GUIDE	(blue button) programme guide
TEXT	(purple button) Teletext
The coloured buttons can also be used for operating Teletext.	
 	To select menu options.
 	To set functions, change values, enable and disable functions (checkbox) in menus. To select the picture format or zoom.
OK	To confirm a selection, enable and disable functions (checkbox) in menus.
MENU	To access the OVERVIEW menu.
EXIT	To exit the menu structure. In PIP mode: to disable the PIP function.
 +/-	To control the volume.
	To switch the sound off and back on again.
RETURN	To return to the previous channel/AV programme.
PR+/PR-	To change channels.
0-9	To select a channel by its number. In the case of channel numbers with two digits: - press the two digits quickly, or - press 0 to display "--", then enter the channel number.
AV	To select an appliance connected to an AV socket.
 DEMO	To access demo mode.

Using the remote control for other equipment

The remote control supplied with your television may vary depending on the model you have chosen. Some remote controls can be used to control other appliances using the programmable buttons **VCR**, **DVD**, **SAT**, **AMP** and **AUX**.

For each button you can control the following appliances:

VCR: video recorder

DVD: DVD player

 **SAT**: satellite receiver, cable network

 **AMP**: hi-fi system, Home Cinema amplifier

 **AUX**: any appliance. For instance, if you have two video recorders, you can program the **VCR** button to control one video recorder, and program the **AUX** button to control the other one.

*Note: The **TV** button is not programmable.*

Programming the remote control

Automatic code search

This method can be used to automatically find the most appropriate code for your appliance.

1. Switch on the appliance you wish to use the remote control with.
2. Press the relevant button for this appliance on the remote control, and while holding this button down, press the  standby button until the light or the appliance buttons of the remote control come on. Release both buttons.
3. Point the remote control at the appliance and press **PLAY**. Wait until the light stops flashing. If the appliance has not gone into standby mode, press the **PLAY** button again to continue the search for the next set of codes. Repeat this operation until the appliance goes into standby mode. There are around 20 sets of codes.
4. When the appliance goes into standby mode, switch it on again without using the remote control. Press the **REV** button as many times as is required to return the appliance to standby mode.
5. Press the **STOP** button and hold it down until the light or the appliance buttons of the remote control go off.

*Note: You can cancel the programming operation at any time by pressing the **EXIT** button.*

Manual programming

This method involves carrying out a manual search for the codes to be used for controlling your other appliances.





1. Switch on the appliance you wish to use the remote control with.
2. Press the relevant button for this appliance on the remote control, and while holding this button down, enter one of the codes relevant to your make of appliance (there is a list of codes at the end of this manual). If the light or the appliance buttons of the remote control flash you have entered the wrong code or it is not possible to program the remote control.
3. Point the remote control at the appliance and press the relevant button (**VCR**, **DVD**, etc). Press the  standby button. If the appliance does not go into standby mode, try another code.

Depending on the year of manufacture and the type of appliance, some functions may not be available. Certain codes may cover more functions than others. Test the functions you can control and, if appropriate, try other codes.

Note here the code(s) which work best.



VCR					AUX				
DVD					AMP				
SAT									

When you **change the remote control's batteries**, remember to **reprogram** it.

	Video recorder	DVD player	Satellite receiver	Hi-fi system
	Press the VCR button On/Standby	Press the DVD button On/Standby	Press the SAT button On/Standby	Press the AMP button On/Standby
MENU	To display the main menu	To display the main menu	To display the main menu	
	Vertical scrolling in menus	Vertical scrolling in menus	Vertical scrolling in menus	
	Horizontal scrolling in menus	Horizontal scrolling in menus	Horizontal scrolling in menus	
OK	To confirm an action	To confirm an action	To confirm an action	
EXIT	To close a menu	To close a menu	To close a menu	
0-9	To directly access channels or enter numeric values	To enter numeric values or select options in menus	To directly access channels or enter numeric values	To select a station using its number
PR+/PR-	To change channels	To change chapters	To change channels	To change stations
AV	To select av input	To select av input		
REV	Rewind	Rewind		
PLAY	Play	Play		
FWD	Fast forward	Fast forward		
STOP	Stop	Stop		
PAUSE	Pause picture	Pause picture		
REC	Record			
				To switch the sound off and back on again
				To set the volume level

Programming the volume control function

If you have programmed the TV remote control to use with other appliances and these are connected to an amplifier you can also programme the remote control to adjust the volume when you are using one of these appliances. The example below describes the procedure for programming a DVD player.

1. Programme the **AMP** button on the remote control to use with the amplifier (refer to page 4).
2. Move the remote control away from the appliances. Press the  - button and while holding it down, press the relevant mode button (**DVD**, in this example), then the **AMP** button. Release the  - button.
3. Switch on the amplifier, then the DVD player.
4. Set the remote control to **DVD**, play a disc and adjust the volume using the  +/- buttons.

Repeat this operation for the other appliances.

To cancel the programmed function for any of the appliances, press the  - button, while holding it down and enter the code 000 using the numeric buttons.

The Learning feature

The Learning feature completes the programming procedure described on page 4, as it enables you to record the functionality of a specific button from the original remote control to one of the TV's remote control buttons.

Notes:

- Before using the Learning feature, make sure this TV's remote control is programmed to control other appliances you have connected to the TV. Programming the remote control erases all learned commands for that appliance mode.
- You cannot record a learned function to the following buttons on the TV's remote control: **TV**, **VCR**, **DVD**, **AUX**, **SAT**, **AMP**, **EXIT**, and **LIGHT**.
- The remote control functions are recorded (learned) by sending infrared (IR) signals: this operation should be carried out in a dimly lit room to avoid interference. Make sure the TV's remote and the original remote are no more than 5 cm apart, with the Infrared (IR) transmitter of the original remote facing the IR receiver on the top of the TV's remote.
- The learned buttons are mode specific—if you add a button function from your DVD player's remote control, you must press the **DVD** button first before the learned function will work (in TV mode, the button where you've stored the learned function will continue to work as it always has).
- Certain remote controls do not support the use of the Learning function.

Adding a Learned Function

1. On the TV remote, press and hold the appliance button that applies to the function you will be adding (**DVD**, **VCR**, **SAT**, **AMP**, or **AUX**). The appliance button lights up. Press and hold the **REC** button.
2. The appliance button lights turn on, then off. Release both buttons. The relevant appliance button light remains on.
3. On the TV's remote control, press the button where you want to store the new function (the appliance button turns off and then back on).

Note: If you press an invalid button on the TV remote, the appliance buttons flash several times to alert you. You'll have to repeat step 3.

4. Press and hold the button of the appliance's remote control that has the functionality you are recording to the TV's remote control. Keep pressing the button until the TV remote's appliance button light turns off and back on. The function has been saved to the TV remote.

Note: If it is not possible to programme this function the appliance buttons flash several times. You'll have to repeat step 3.

5. Repeat this procedure to add more functions. Or, press **EXIT** to exit learning mode.

Note: If you want to assign a new function to a button already programmed, you must record over it.

Clearing a Learned Function

1. Press and hold the relevant appliance button (the appliance button lights up). Then press and hold the **EXIT** button.
2. The appliance buttons turn on. Release the appliance and **EXIT** buttons (the appliance button being unprogrammed remains on). Remote is now in Clear learned function mode.
3. Press the button where learning is to be cleared. The appliance button flashes off then back on—the learned function was cleared successfully.
4. Repeat steps 1 through 3 to clear more learned functions.

Note: If an invalid button is pressed, the appliance mode button(s) flashes 4 times to alert you. Repeat step 3.

5. Press the **EXIT** button and your TV remote returns to its original operating mode.

Deleting ALL Learned Functions

1. Press and hold the **EXIT** button. The current appliance button lights up. Then press and hold the  button.
2. The appliance button lights turn on, then off. Release both buttons. The current appliance button light remains on.
3. Press any appliance button to delete all learned functions in all modes.

Important: If the batteries in your remote control are run down, you can use the buttons on the front of your set, as they have the same functions as those on the remote control.

Switching on

Follow the instructions on this page on how to switch on your TV set and the remote control before going on to the following pages that describe how to use the remote control and the channel set-up procedure.

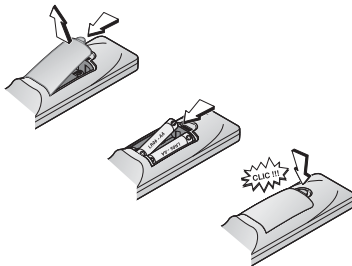

1. Insert two LR06 or AA batteries in the remote control.

Precautions on using batteries:

- Only use the battery types specified.
- Make sure you use the correct polarity.
- Do not mix new and used batteries.
- Do not use rechargeable batteries.
- Do not expose batteries to excessive heat, throw them in a fire, recharge them or try to open them, as this could cause them to leak or explode.
- Remove the batteries from the remote control if you are not using it for a long period of time (several weeks).

220 - 240 V ~ 50 Hz

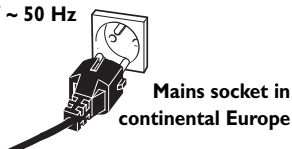

2. Connect the power cable **FIRST** to the television, **THEN** to a mains socket.

Your TV set should only be connected to a 220 - 240 V ~ 50 Hz AC supply. It must not be connected to a DC supply. If the plug is detached from the cable, do not, under any circumstances, connect it to a mains socket, as there is a risk of electric shock.

Equipment for the UK and Ireland is supplied with a mains cable fitted with a moulded plug.

This plug contains safety components and must not be replaced by one sold by general retailers. It is fitted with a fuse that protects your television. If your set has stopped working, the fuse may have blown. If it has, replace it with an identical ASTA or BSI certified (BS 1362) 5-amp fuse.

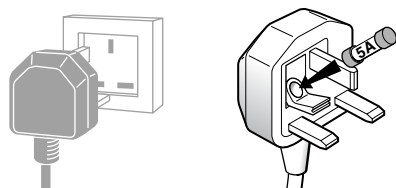

3. Connect the outside aerial or cable network to the TV ANT socket inside the front panel of the TV set (see page 24).

The aerial socket (75 Ohms - VHF / UHF / cable) can be used for connecting an external aerial or other equipment fitted with a modulator (video recorder, satellite receiver, etc.).

We recommend that you do not connect other equipment (video recorder, satellite receiver, etc.) to your TV set to begin with, so as not to complicate the set-up procedure with the additional steps involved. Connect them when you have finished setting up the channels by referring to page 24 of this manual.

If you have a NextView Link video recorder (refer to the connecting diagram at the end of this manual, inside the cover), you must connect it to the AVI socket of the TV set using a Scart cable before proceeding to the initial set-up.

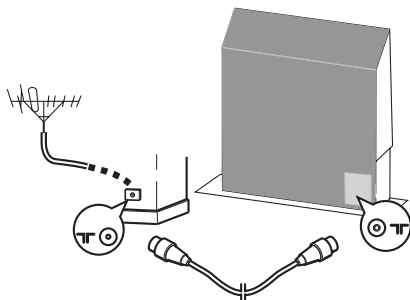

4. Switch the TV on by pressing the on/off button under the front panel of the TV set. The TV set takes up to 40 seconds to come on.

Note: The first time you switch on the television, the language selection menu appears.

Important: read carefully the sections “Specific precautions for DLP™ TV sets” on page 3 and “Switching the TV set on and off” on page 10, which give a detailed description of the procedure for switching the TV set on and off.

You will find a description of how to use the remote control on page 4. Then go to page 8 for information on the initial set-up, or to page 9 for information on manual set-up (if the channels have already been set up on your TV).

Note: Before connecting other devices to the AV sockets, carry out the initial channel set-up (described on the next page) in order to avoid any problems with equipment selection.

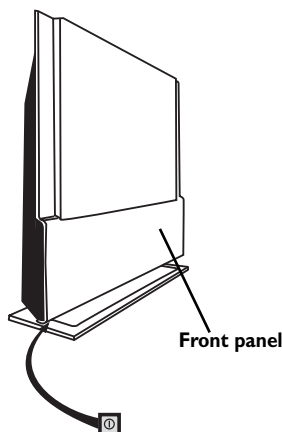

Please respect the environment and the relevant regulations. Before you dispose of batteries (or accumulators), ask your dealer whether they require special recycling and if he is able to take them back.

Initial set-up

Initial set-up involves searching for and storing all the channels you can receive. Make sure that the television is switched on and follow the six steps in turn specified on this page.

The first time you switch the television on, the language selection menu appears.

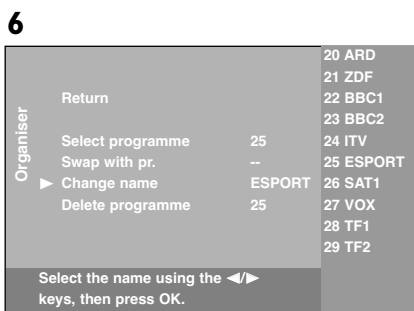
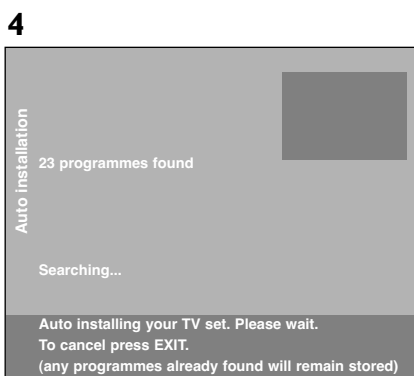
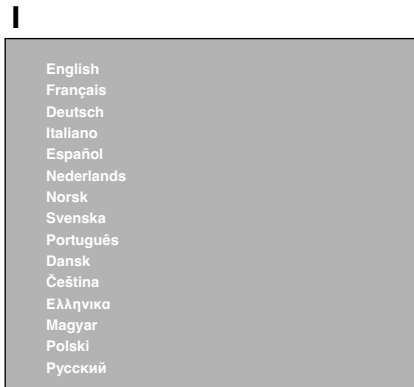

1. Select your language using the ▲ ▼ buttons and confirm by pressing **OK**. A welcome message appears in the language you have just chosen. Press **OK**.

2. A list of countries appears, over two pages. Select the relevant country using the ▲ ▼ buttons. Press **OK** to confirm.

Note: This is the country you are in, or the country whose channels you want to receive if you live near its borders.

3. A message appears asking you to check that your aerial is connected, and if relevant, to connect your decoder. Once this operation has been carried out, press **OK**.

*Note: If you connect a decoder to the AVI socket, after completing the initial set-up, you must enter the **Manual Install** menu and select **AVI** for the **Decoder** option. Refer to page 9.*

4. The **Installation** menu appears. The **Auto installation** option is selected. Start the automatic set-up by pressing **OK**.

Notes:

- The automatic set-up process can take up to 10 minutes. The menu that appears tells you how the process is progressing. To prevent the channel set-up process from being interrupted, wait for the message indicating that the set-up is complete before closing the menu.

- The automatic set-up process deletes all the channels previously stored.

5. Channels are arranged in a pre-set order.

- To modify this order, name and rename channels or delete channels stored twice, press **OK** and go to step 6.

- If you do not want to reorganise the channels, press **EXIT** to close the menu.

6. The **Organiser** menu allows you to change the order of the channels as arranged during the automatic set-up process, to name or rename channels, as well as delete channels stored twice or with poor reception quality. Simply follow the instructions at the bottom of the screen. Use a TV programme magazine to identify the channels.

- Organising channels: Select the **Select programme** option. Using the **PR+/PR-**, ◀ ▶ or numeric buttons, display the channel number and look for the channel to be moved. Select the **Swap with pr.** option and enter the number you want to assign this channel to. Press **OK**.
- Changing a channel name: Select the **Select programme** option. Using the **PR+/PR-**, ◀ ▶ or numeric buttons, display the number of the channel whose name you want to change. Select the **Change name** option and choose a name from the list using the ◀ ▶ buttons. Press **OK**.
- Deleting a channel: Select the **Select programme** option. Using the **PR+/PR-**, ◀ ▶ or numeric buttons, display the number of the channel to be deleted. Select the **Delete programme** option and press **OK**.

When you have finished press **EXIT** to close the menu.

To access the **Organiser** menu another time, press the **MENU** button to display the **OVERVIEW** menu, select **Installation** and press **OK**. Then select **Organiser** from the **Install.** menu.

The **Contact us!** screen then appears. This displays the Thomson Europe website address and Helpline telephone number (see page 2), as well as your TV set's serial number.

*Note: The **Contact us!** screen appears automatically after the initial set-up is complete. To access it later on, press **MENU** to display the **OVERVIEW** menu, select **Contact us!** and press **OK**.*

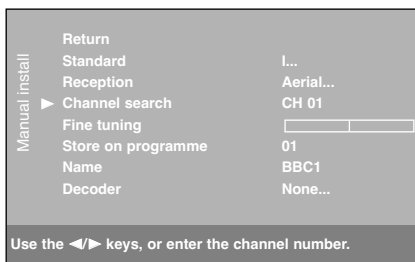

Manual channel set-up

Follow the procedure given on this page if you find that some channels have not been stored during the initial set-up. This can happen if you are setting up cable network channels. Setting up channels manually requires every setting for a particular channel to be entered, one at a time.

Display the **OVERVIEW** menu by pressing the **MENU** button. Select the **Installation** option and press **OK** to confirm. Select the **Installation** option from the **Install** menu and press **OK** to confirm.

1. Select your country using the **<>** buttons. Press **OK** to confirm. The **Connections** screen appears. Press **OK** to continue. The **Installation** menu appears. Select the **Manual installation** option and press **OK**.

Define all the settings in turn for each channel to be stored. Follow the instructions appearing at the bottom of the screen.

2. Select the **Standard** option. Use the **<** or **>** button to select the standard for your country.

*Note: The following standards are available to choose from: **I** for the UK and Ireland, **France** for France and Luxembourg, **DKK'** for Eastern Europe, the Middle East and Asia, **EURO BG** for Western Europe, Australia and New Zealand.*

3. Select the **Reception** option. Select the reception method for the channels (aerial or cable network) using the **<** or **>** button.
4. Select the **Channel search** option. Enter the number of the reception channel or use the **<>** buttons to find the channels. When a channel has been found the picture is displayed.
5. If the picture is not clear you can adjust the setting. You do this by selecting the **Fine tuning** option and adjusting it with the **<>** buttons.
6. If the channel is recognised, its name is detected automatically, otherwise change the name suggested or enter a name. To do so, go to the name with only its initial letter in yellow. Choose the character to be changed using the **<>** buttons. Scroll through the alphabet using the **1** and **2** buttons. Go to the next character using the **<>** buttons.
7. If the channel is encoded and you want to connect a decoder to the AVI socket, select the **Decoder** option and select **AVI** using the **<** or **>** button.
8. Then select the **Store on programme** option and enter the number to be assigned to this channel using the numeric buttons (for instance, for BBC1 type 01). Press **OK**.



Important: Whenever you change a value in the **Manual install** menu, the **Store on programme** option starts flashing. To confirm your change you need to select the **Store on programme** option and press **OK**. If you do not confirm the change it will be cancelled when you change channels or put the TV set in standby.

Repeat this procedure to find other channels.

Notes:

- For cable networks, to search for missing channels, select **Other** instead of a country, then select **Auto update** in the **Installation** menu.
- If you wish to go through the whole initial set-up process, put the TV in standby mode, then hold down the **PR+** and **<+>** buttons on the television until the menu displays. Proceed as for the initial set-up.
- Subsequent set-ups:
 - The **Auto update** function allows you to set up channels just launched or any channels that are missing or wrongly set up.
 - The **Auto installation** function is used for setting up channels after the initial set-up (e.g. after moving house). This process deletes all channels previously stored. To set up a new channel, it is better to use **Auto update** or **Manual installation**.

Switching the TV set on and off







- To switch the TV set on, press the  button located under the front panel of the set. The TV set takes up to 40 seconds to come on. If the indicator on the front is red, the set is in standby mode. You can then:
 - press the  or any numeric button on the remote control,
 - press the **TV, OK** or **PR+/PR-** buttons to switch the television on at the last channel or AV programme you were watching,
 - press the **AV** button to switch the television on at the last AV programme you were watching.

When the set is on, the indicator on the front is **blue**.

- To put the TV set in standby mode, press the  button on the remote control. When the set is in standby mode, the indicator on the front is **red**. The TV set remains powered up, but with low energy consumption.
- To switch off the TV set, press the on/off button under the front panel of the set.

Note: The fan continues to run for about another two minutes after the TV set has been switched off.

Volume

- Volume control: use the  +/- buttons on the front of the TV set or press the relevant buttons on the remote control to increase or decrease the volume.
- Sound mute: press the  button to temporarily mute the sound. Press this button again or the  + button to restore it.
-  Headphone volume control: press the  +/- button on the remote control to display the volume control bar. Then use the  buttons to switch to the headphone volume control bar. Use the  buttons to adjust the volume.

Displaying status information

In TV mode, press the yellow button (**INFO**) on the remote control to display the number and name of the channel you are watching, the time, the type of sound, the zoom or format, and the status of the Parental control function.

If the programme guide is available for this channel, the name of the programme currently showing is displayed, along with its start time and duration and the name and start time of the following programme are also displayed.

When you switch on the television or change channels, the number and name of the channel are displayed.

*Note: If you activate the **Permanent pr. number** function in the **Preferences** menu, the channel number will be displayed permanently (see page 18).*

Accessing channels

- Using the numeric buttons:
 - for channels 1 to 9, press the corresponding button;
 - for channels 10 to 99,
 - press the tens digit for a few seconds to display it on the screen, then press the units digit. For instance, for programme 24, press and hold 2 to display 2-, then press 4; or
 - press the 0 button to display "--", then enter the two digits.
- Using the **PR+/PR-** buttons: scroll through the channels. AV programmes are not included in the cycle unless you use the buttons on the front of the TV set.
- Using the list of programmes: refer to page 11.

To access the channel or AV programme previously being watched, press the **RETURN** button

Accessing AV programmes

Press the **AV** button to display the last selected audio-visual programme and scan through the other audio-visual programmes.

Demo mode

This mode is used to highlight the benefits of the Hi Pix setting.

Press the **DEMO** button on the remote control to switch to Demo mode. The TV set alternates between on and off with the Hi Pix setting. Press the **DEMO** button as many times as you need to exit Demo mode.

Zoom

In TV mode, you have the option of changing the display format and using the zoom function via the **<>** buttons. The available formats and zoom functions are:

4/3 format - picture in centred 4:3 format

Zoom 14/9 - picture in centred letterbox 14:9 format

Zoom 16/9 - picture in centred letterbox 16:9 format

Zoom 16/9 ▲/▼ - picture in 16:9 format with subtitles

Cinerama - picture in widescreen 4:3 format

16/9 format - picture in widescreen 16:9 format

In **Zoom 14/9**, **Zoom 16/9**, and **Zoom 16/9 ▲/▼** modes, you can temporarily shift the picture up and down using the **▲ ▼** buttons.

This function is not available for Progressive Scan sources (480p, 576p) and HD sources (720p and 1080i).

List of programmes

Press the **LIST** (green) button on the remote control to display the list of programmes. It has 11 pages and shows the name and the number of each programme. The last page lists units connected to the AV sockets.

The list appears on the page featuring the channel or AV programme which you are currently watching. The channel or AV programme you are watching is indicated by a symbol. Any channels and AV programmes which are locked are indicated by a red closed padlock and those temporarily unlocked are indicated by an open green padlock.

Note: For more information on locking channels, refer to the Parental control section.

To watch one of the programmes on the displayed page, use the **PR+/PR-** or **▲ ▼** buttons and press **OK**. You can also enter the last digit of the programme number (for example, 5 for 25). The selected programme is shown.

You can scroll through the pages using the **<>** buttons.

Press **EXIT** to close the menu.

Freezing a picture

Press the **FREEZE** button to freeze the picture. Press any button on the remote control or TV set to cancel this function. In PIP mode, press the **FREEZE** button to freeze the main picture.

Flat batteries

When the batteries are flat a message appears on the screen when you press a button on the remote control.

You should change the batteries and reprogram the remote control (see page 4).

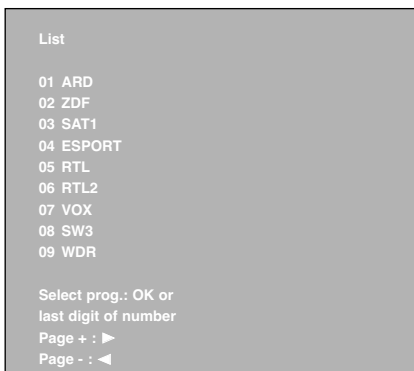

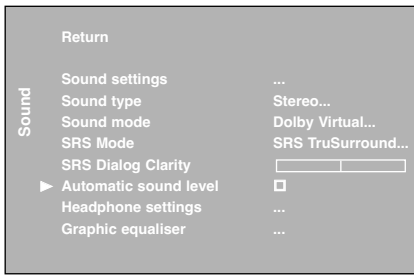

1

Broadcast	Options
Mono	Automatic - Mono
Stereo	Mono - Stereo
Dual	Sound 1 - Sound 2
NICAM - 3	Sound 1 - Sound 2 - Sound 3
Analog AV	Stereo - Sound 1 - Sound 2

2

Sound type	Options
Mono	Normal - Wide
Stereo	Normal - Virtual Dolby PLII
Sound 1	Normal - Wide
Sound 2	Normal - Wide

3

Sound mode	Options
Normal*	SRS TruSurroundXT SRS TruSurround SRS TruBass - Off
Wide	SRS TruBass - Off
Virtual Dolby PLII	SRS TruSurroundXT SRS TruSurround

* Only the options SRS TruBass and Off are available for mono sources.

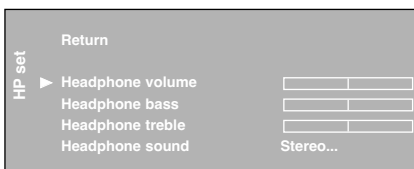
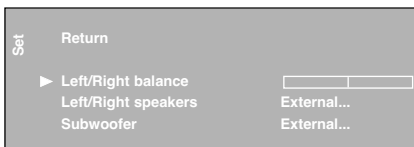

Adjusting the sound

Display the **OVERVIEW** menu by pressing the **MENU** button. Select the **Sound** option and press **OK** to confirm. The **SOUND** menu appears with the following options:

Sound settings: see further below.

Sound type: select a sound type from the list using the **<>** buttons.

The default sound type is **Automatic** for mono sources, **Stereo** for stereo sources and **Stereo** for AV sources.

Note: The options offered depend on the programme you're watching. Refer to the table I opposite.

Sound mode: The options available depend on the sound type selected (refer to table 2 opposite).

Default mode for mono sources is **Normal** and **Virtual Dolby PLII** for stereo sources.

SRS Mode: the options available depend on the mode selected (refer to table 3 opposite)

Using the **<>** buttons, select an option from the list:

SRS TruSurroundXT: reproduces virtually via two channels only the sound of a multichannel source and enhances the dialogue and bass output.

SRS TruSurround: reproduces virtually via two channels only the sound of a multichannel source.

SRS TruBass: enhances the bass output.

SRS Dialog Clarity: this function boosts the central channel to make dialogue easier to understand. You can use the **<>** buttons to adjust it.

*Note: This option only appears if you have selected **Normal** or **Virtual Dolby PLII** under **Sound mode** and **SRS TruSurroundXT** under **SRS Mode**.*

Automatic sound level: check the box by pressing the **OK** button, if you want to keep the same sound level for all channels.

Headphone settings: this option allows access to the headphone setting menu (see further below).

Graphic equaliser: this option allows access to the graphic equaliser (see further below).

Press **EXIT** to close the menu. Select **Return** and press **OK** to return to the **OVERVIEW** menu.

Configuring the sound settings

You can configure the sound environment according to the loudspeakers you connect to the TV set.

Select the **Sound settings** option from the **Sound** menu and press **OK** to confirm. The options are the following:

Left/Right balance: balance the sound between the left and right speakers.

Left/Right speakers: select **External** if you have connected external side speakers (see page 24), **Internal** if you have not. Otherwise, there would be no sound.

Subwoofer: select **None**, if you do not want to use a subwoofer; **Internal**, if you are using the television's subwoofer; **External**, if you have connected an external subwoofer.

*Note: The **Internal** option is only available if the television has a subwoofer.*

Press **EXIT** to close the menu. To return to the **Sound** menu, select **Return** and press **OK** to confirm.

Headphone settings

Select the **Headphone settings** option from the **Sound** menu and press **OK** to display the menu. Then select each option in turn, using the **<>** buttons to adjust the volume, bass and treble level and select the sound type.

Press **EXIT** to close the menu. To return to the **Sound** menu, select **Return** and press **OK** to confirm.

Graphic equaliser

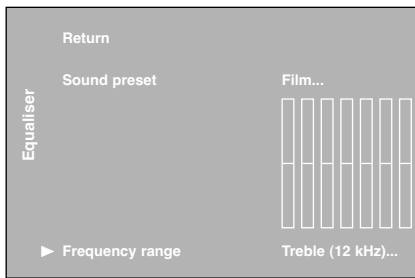

Select **Graphic equaliser** from the **Sound** menu and press **OK** to display the menu. This menu is used to select a preset parameter and define your own settings using the graphic equaliser. It offers the following options:

Sound preset: use the **<>** buttons to select the appropriate setting for the programme you are watching.

The **Personal** setting stores your graphic equaliser settings.

You can access the list of preset sound settings directly by pressing the red button on the remote control, selecting the **Sound preset** option and choosing one of the preset parameters from the list. Your selection is applied to all channels and AV programmes.

Frequency range: the graphic equaliser has seven frequency bands. Select each band in turn using the **<>** buttons and make the necessary adjustments using the **^** **v** buttons. Press **OK** to confirm.

Note: When you are setting the graphical equaliser, **Personal** appears under the **Sound preset** option.

Press **EXIT** to close the menu. To return to the **Sound** menu, select **Return** and press **OK** to confirm.

Adjusting the picture

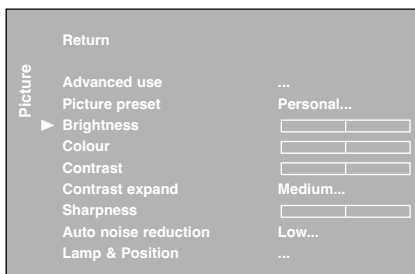

The menus for adjusting the picture are used to obtain the best picture setting according to your preference, the type of programme you are watching and the ambient lighting. When you make an adjustment only the selected option remains displayed, allowing you to see the changes taking place on screen. The entire menu is displayed again when you select another option or the time for making an adjustment has elapsed.

Display the **OVERVIEW** menu using the **MENU** button. Select **Picture** and press **OK** to confirm. The **Picture** menu appears with the following options:

Advanced use: this option provides access to the **Advanced use** menu (see further below).

Picture preset: use the **<>** buttons to select the appropriate setting for the programme you are watching.

Personal contains the values you have defined for the settings **Brightness**, **Colour**, **Contrast** and **Sharpness**.

You can access the list of preset picture settings directly by pressing the red button on the remote control, selecting the **Picture preset** option and choosing one of the preset parameters from the list. Your selection is applied to all channels. You must, however, select a preset parameter for each AV programme.

Note: This function is not available in PIP **Split screen** mode.

Brightness, **Colour**, **Contrast**, **Sharpness:** adjust these settings as required.

Note: These settings are automatically stored under **Personal** under the **Picture preset** option.

Contrast expand: can be used to adjust the picture according to the ambient brightness. Select an option from the list using the **<>** buttons.

Auto noise reduction: improves the quality of the picture in the case of poor reception. Select an option from the list using the **<>** buttons.

Note: This function is only available for certain audio-visual sources.

Lamp & Position: this option provides access to the **Lamp & Position** menu (see further below).

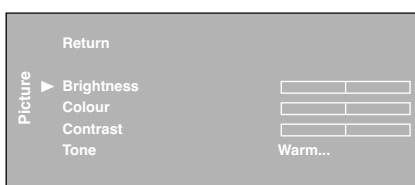

Some menu options are not available in PIP **Split screen** mode (see opposite).

Press **EXIT** to close the menu. To return to the **OVERVIEW** menu, select **Return** and press **OK** to confirm.

Advanced functions

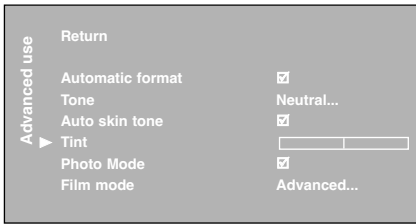

Advanced use

Select the **Advanced use** option from the **Picture** menu and press **OK** to display the menu. The options are the following:

Automatic format: automatically applies the appropriate format to the picture. Check this box by pressing **OK** to enable this function.

Tone: adjusts the colour temperature. Select an option from the list using the **<>** buttons.

Auto skin tone: improves skin tone rendering. Check the box to enable this function by pressing **OK**.

Note: This function is only available for NTSC audio-visual sources.

Tint: is used to adjust the picture's tint.

Note: This function is only available for NTSC audio-visual sources.

Photo Mode: improves quality and stability of still pictures. When this function is enabled still pictures are detected automatically and their resolution enhanced. Check the box to enable this function by pressing **OK**.

Note: This function is only available for certain audio-visual sources.

Film mode: detects that the programme being broadcast is a film and enhances picture quality. Select an option from the list using the **<>** buttons:

Off: function disabled,

On: detection,

Advanced: detection, then enhancement of picture quality.

*Note: The **Advanced** option is selected by default.*

Press **EXIT** to close the menu. To return to the **Picture** menu, select **Return** and press **OK** to confirm.

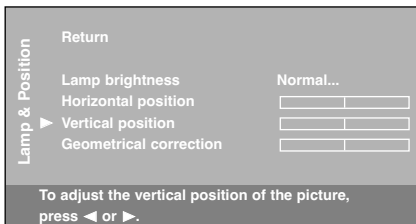

Lamp & Position

Select the **Lamp & Position** option from the **Picture** menu and press **OK** to display the menu. The options are the following:

Lamp brightness: this function is used to adjust the lamp brightness. Select an option from the list using the **<>** buttons.

*Note: The **Boosted** option increases brightness but reduces lamp life.*

The help text also indicates the relevant lamp type for your set.

Write down here the lamp type for future reference:

Horizontal position: use the **<>** buttons to move the picture horizontally on the screen.

Vertical position: use the **<>** buttons to move the picture vertically on the screen.

Note: You can adjust the vertical and horizontal positions for each source.

Geometrical correction: use the **<>** buttons to correct a possible trapezoidal effect of the image.

Press **EXIT** to close the menu. To return to the **Picture** menu, select **Return** and press **OK** to confirm.

	Return	
Time	▶ Sleep timer	00:15
	Clock reference programme	02
	Time and date	12:34 03/03/03
	Wake-up timer	<input checked="" type="checkbox"/>
	Wake-up time	07:00
	Switch on for	01:00
	Programme number	10 CNN
	Daily	<input type="checkbox"/>

Setting the time

The **TIME** menu can be used to set the time on the TV set and program the automatic sleep timer or wake-up timer functions.

Display the **OVERVIEW** menu by pressing the **MENU** button. Select the **Time** option and press **OK** to confirm.

Setting the time

1. Select the **Clock reference programme** option.
2. Select a channel with Teletext which can provide the time to be used as a reference using the **<>** buttons, or enter a channel number using the numeric buttons on the remote control. The time is displayed after a few seconds if it is available on the selected channel.

If the time is not provided by Teletext the **Wake-up timer** function is not available and a message prompts you to change reference channel or enter the time manually. You do this by selecting the **Time and date** option and entering the time using the numeric buttons or the **<>** buttons.

Note: If the power supply is disrupted (i.e. the set is switched off using the on/off button or unplugged, or there is an electrical fault), the time will disappear if it has been entered manually. You must reset it. We therefore recommend you find the time on a channel and check that it is correct.

Once the time has been set you can use the **Wake-up timer** function.

Programming the sleep timer

1. Select the **Sleep timer** option.
2. Set an automatic shut-off time (from 0 to 4 hours in 5-minute intervals) by using the **<>** buttons. Set the time to 00:00 to disable this function.

When the sleep timer is on, a message appears one minute before the television set goes into standby mode. Press any button on the remote control to cancel standby mode.

Programming the wake-up timer

This function can be used to set the time for the set to come on, for instance, for the television to wake you up.

1. Select the **Wake-up timer** option and press **OK** to check the box, which enables this function and provides access to the relevant options.
2. Under the **Wake-up time** option enter the wake-up time using the numeric or **<>** buttons.
3. Under the **Switch on for** option, use the **<>** buttons to set the period of time (from 5 minutes to 4 hours in intervals of 5 minutes).
4. Under the **Programme number** option enter the number of the channel you want to wake you using the **<>** or numeric buttons. You can also select an AV programme using the **AV** button. In this case, make sure you programme the equipment connected to the AV socket to come on as well.
5. For a daily wake-up check the box for the **Daily** option by pressing **OK**.
6. Press **EXIT** to close the menu.
7. Put the TV set into standby mode using the **⏻** button on the remote control.

The TV set will automatically switch on at the programmed time and for the programmed duration if you do not interrupt it by using the remote control.

Parental control

The parental control functions allow you to limit your children's access to the television. You can do this by locking the buttons on the front of your TV set, thereby barring access to certain channels and/or AV programmes. These functions are protected using a PIN code.

Accessing the Parental control menu

1. Display the **OVERVIEW** menu by pressing the **MENU** button. Select the **Parental control** option and press **OK** to confirm.
2. If the parental control function is not on, follow the instructions on the screen to access the menu. If it is on, the **Pwd** menu appears. Enter your 4-digit code to access the menu. On the screen the numbers are replaced with asterisks. The **Parental control** menu appears.

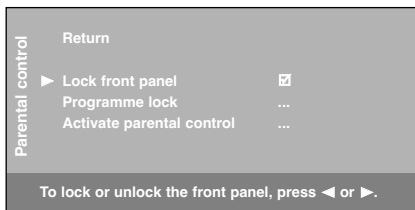

Locking the buttons on the front of the TV set

1. Select the **Lock front panel** option from the **Parental control** menu and check the box by pressing **OK** or the **<>** buttons.
2. Select the **Activate parental control** option and press **OK**. The **Lock** menu appears.
3. Enter a 4-digit code, then enter it again to confirm it. A message appears saying that the parental control is on. Press **EXIT** to close the menu. Press any other button to return to the **Parental control** menu.

*Note: The **Installation** menu is also locked and the remote control is needed to be able to use the television.*

To cancel the lock, go to the **Parental control** menu by entering your code and uncheck the **Lock front panel** box by pressing **OK**. Press **EXIT** to close the menu.

Locking a channel or AV programme

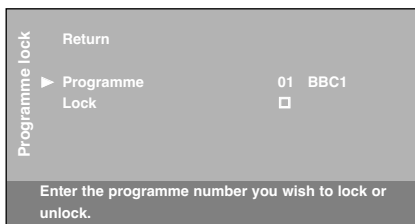

1. Select the **Programme lock** option from the **Parental control** menu and press **OK**. The relevant menu appears.
2. Under the **Programme** option use the **<>** buttons, numeric or **PR+/PR-** buttons to select the channel to be locked. Use the **<>** buttons or press the **AV** button to access the AV programmes.
3. Check the **Lock** box by pressing **OK** or using the **<>** buttons.
4. Select the **Return** option and press **OK** to return to the **Parental control** menu.
5. Select the **Activate parental control** option and press **OK**. The **Lock** menu appears.
6. Enter a 4-digit code, then enter it again to confirm it. A message appears saying that the buttons on the front are locked. Press **EXIT** to close the menu. Press any other button to return to the **Parental control** menu.

To unlock the channel or AV programme, go to the **Parental control** menu by entering your code and access the **Programme lock** menu and uncheck the **Lock** option by pressing **OK**.

Operation (TV mode)

- To watch a channel or AV programme which is locked, try accessing it and follow the procedure on the screen. The lock will be applied again when you put the television in standby.
In the list of programmes, channels and/or AV programmes which are temporarily unlocked are indicated by an open green padlock.
- The parental control function must be enabled without fail in order to be able to apply a lock. To do this you need to select the **Activate parental control** option from the **Parental control** menu to define a personal code.

- Whenever you enable the parental control function by defining a personal code you have to enter your code to access the **Parental control** and **Installation** menus, even if there is no lock on. In the **Parental control** menu the option is replaced by **Deactivate parental control**.
- To disable the parental control function, access the **Parental control** menu by entering your personal code, select the **Deactivate parental control** option and enter your code again. This option is then replaced by **Activate parental control**.
- The personal code is deleted every time you disable the parental control function. This means you have to redefine it every time you enable this function again.
- Whenever you enter your code all the locks are disabled until the set is put in standby again.
- If you have forgotten your PIN code you can cancel it:
When you are prompted to enter your code to access the **Parental control** menu, press the **PR+** and **△+** buttons on the front of your set at the same time for eight seconds. This procedure is possible, even if you have locked the buttons on the front of the TV set.

Picture in picture (PIP)

Press the **MENU** button to display the **OVERVIEW** menu. Select **Picture in Picture** and press **OK**. The menu displays. Under the Display mode option, select one of the following PIP display modes:

Off: PIP is disabled.

Single: a channel or av programme is displayed in a frame in a corner of the screen.

Split screen: the screen is divided vertically in two and the PIP is displayed on the right side. Sound comes from the main programme, on the left.

When you enable the PIP function, the other options in the menu are displayed.

- In **Single** mode, you can select the programme, the zoom and the position of the frame on the screen. Select an option from the list each time using the **◀▶** buttons.
- In **Split screen** mode, you can select the programmes to be displayed in both pictures. Use the **PR+/PR-** buttons to change programmes on the left side of the screen and use the **PIP+/PIP-** buttons to change programmes on the right side of the screen. Use the **SWAP** button to swap pictures.

Press **EXIT** to close the menu. Select the option **Return** and press **OK** to return to the **OVERVIEW** menu.

Operation (TV mode)

- Use the **PIP** button on the remote control to enable the different display modes in turn.
 - In both display modes:
 - Use the **SWAP** button to swap the channels around.
 - Press the **FREEZE** button to freeze the main picture.
 - To apply the PIP function to an AV programme in RGB, you need to select **RGB** as the relevant AV source in the **AV Settings** menu (see page 19).
 - In Single mode:
 - Use the **PIP ZOOM** button to change the size of the PIP picture.
 - In **Split screen** mode:
 - Teletext on the channel displayed on the left appears on the right side of the screen. Press **EXIT** to disable this function.
- Use the **PIP+/PIP-** buttons to change programmes on the right side of the screen.

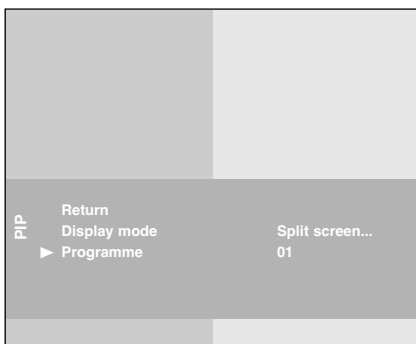
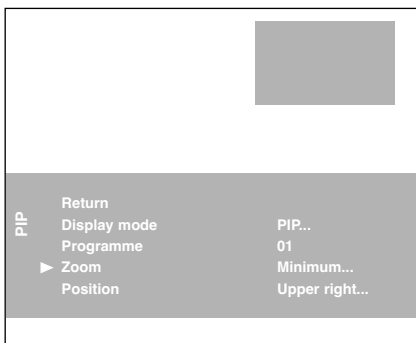

Customising your television

Preferences

You can set preferences for some features. These preferences remain in force as long as you do not change them.

Press the **MENU** button to display the **OVERVIEW** menu. Select the **Installation** option and confirm by pressing **OK**. Select **Preferences** from the **Install** menu and press **OK** to confirm.

The **Preferences** menu offers the following options:

Permanent pr. number: check this box using the **OK** button to permanently display the number of the programme being watched.

Language: select from the list the language the menus will be displayed in using the **<>** buttons.

Country: select the country to ensure that characters display correctly in Teletext.

Maximum TV volume: set the maximum volume level using the **<>** buttons. To hear the level that you have just set, press the **OK** button and hold it for a few seconds.

Program Info ref. pages: if you have changed reference page for the TV channels in Teletext you can restore the factory-set reference pages by pressing the **OK** button for about five seconds until **Done** appears.

Front panel light: this function is used to activate and control the brightness of the lighting for the buttons on the front of the TV set. Use the **<>** buttons to select one of the six settings available.

When the cursor is completely to the left, as shown in the example opposite, the lighting is off.

When the lighting is on, the buttons on the front of the TV set come on when you switch the set on and go off when you put the TV set into standby mode or switch it off.

Teletext adjustment: use this function if one of the following situations occurs.

- Some channel names are missing following auto installation. Check/uncheck the box using **OK** and run autoinstallation again.

- Teletext subtitles are not visible or are frozen. Check/uncheck the box using **OK** and access the Teletext page displaying the subtitles.

- Some Teletext lines never display. Check/uncheck the box using **OK** and access the Teletext page again.

The box is checked by default.

Press **EXIT** to close the menu. Select the option **Return** and press **OK** to return to the **Install** menu.



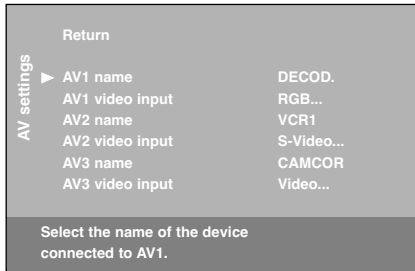

Configuring AV sockets

You can configure your TV set according to the equipment you connect to it.

Display the **OVERVIEW** menu using the **MENU** button. Select the **Installation** option and press **OK** to confirm. The **Install** menu appears. Select the **AV settings** option and press **OK** to confirm.

Follow the messages on screen and the instructions below explaining how to configure the AV sockets.

AV1 name: Use the **<>** buttons to select from the list the name of the equipment connected to this socket. If the factory preset names do not suit you, select **AV1__** and enter another one, following the screen messages.

AV1 video input: use the **<>** buttons to select from the list the type of video signal transmitted by the equipment connected to the AV1 socket.

*Note: Select **RGB** if no picture is displayed when you connect a games console.*

Repeat the above procedure to configure the AV2 and AV3 sockets.

AV4 name: enter the name of the equipment connected to this socket.

Note: This option is only displayed if your equipment has a synchro scan socket.

AV5 name: enter the name of the equipment connected to this socket.

Note: This option is only displayed if your equipment has a DVI socket.

Press **EXIT** to close the menu. Select the option **Return** and press **OK** to return to the **Install** menu.

Teletext

The Teletext service is available in many countries under a variety of names (TOP Text, Fastext, FLOF text, Videotext). It is provided as a free service by television broadcasters. This service provides a real wealth of information, available at any time, on weather, sports results, news, games, etc. The information is presented in pages or organised in topics specified in colour on the screen and you can access this information by simply pressing the buttons of the relevant colour on the remote control.

Accessing Teletext

Press the **TEXT** button on the remote control. Teletext will display the last page selected, or if you have changed channel, the index page (usually 100). If the particular programme does not provide a Teletext service, a message will appear to this effect.

To display a page, enter its 3-digit number or use the **PR+/PR-** buttons. The page appears after a few moments. The entered number appears:

- red if the page number has not yet been found,
- white if the page has been found,
- green when a sub-page has also been found for this page,
- yellow when the page exists but has not been found yet.

If the current page includes subpages, the page number is displayed in green. In this mode, pressing the **< >** buttons will allow you to step through all the available subpages.

You can select a specific subpage number by pressing **0** to enter subpage direct access mode. The display will look like this: 120 ----. You can then enter the four digits of the subpage number using the numeric buttons (e.g. 0003).

Navigator

The navigator, located on the left of the screen, provides access to the following functions:

Stop

Some information is spread over several subpages which will be displayed one after the other. To stop subpage scrolling, select **STOP** and press **OK**. Press **OK** to allow the information to move again.

If you select **STOP** and the symbol changes colour, this means that there are no subpages.

Hidden answers

To reveal a hidden answer (for example, in games), select **?** and press **OK**. Press **OK** once more to hide the answer again.

Zoom

Select  and press **OK**: once to zoom in on the top part of the screen, twice to zoom in on the bottom part of the screen and three times to return to normal display.

Mixed display

Select  and press the **OK** button to display Teletext in the right half of the screen.

Press the **EXIT** button to quit Teletext.

Note: Your television can receive Teletext level 2.5. Teletext level 2.5 information is displayed automatically when available. This version of Teletext offers better quality graphics and can be used by broadcasting companies to provide additional columns.

Other Teletext functions

Newsflash

When a newsflash is detected, the  icon is replaced with a **N** in the navigator. Select it and press **OK** to display the newsflash. In the case of an update, the Teletext function is enabled and displays the new information.

Subtitles

Some channels provide subtitles for some of their programmes. The number of the relevant pages is specified on the Teletext index page.

To display subtitles, enable the Teletext function, find the number of the page displaying the subtitles and enter it. Once the relevant page is found, the subtitles appear in the TV picture. The navigator disappears after a couple of seconds. To display it again, press the purple (**TEXT**) button.

Alarm page

In some countries (Spain, Benelux, etc.), you can set a time to display certain Teletext pages (alarm pages).

To do this, display the relevant alarm page and enter subpage mode. Enter the time instead of the subpage number (e.g. 1705 for 17:05) and press **EXIT**. The page will disappear and will appear again at the set time, as long as you do not change channels or switch off the TV beforehand.

Direct access

The yellow and blue buttons on the remote control allow you to access directly those pages whose numbers are displayed in yellow and blue at the bottom of the screen.

Fastext

Fastext displays a bar at the bottom of the page divided into four coloured sections (red, green, yellow and blue), which provide links to the topics you can access by pressing the relevant colour button. Other topics accessible in the same way can also be displayed.

TOPtext

TOPtext displays a bar at the bottom of the page divided into two coloured sections (yellow and blue). The blue section displays a topic you can access directly by pressing the blue button. The next topic will then appear in the blue section.

The yellow section displays an article you can access directly by pressing the yellow button. The next article will then appear in the yellow section.

Storing the programme page

If the broadcasting company changes its Teletext pages, you have to store the new programme page to be able to access the programme guide (see page 22).

To do this, display the current programme page and select the **?** symbol. Press the **OK** button until the message "**Store for Program Info: OK. Cancel: 0**" appears at the bottom of the screen. Press **OK**. Press **EXIT** to quit Teletext and display the programme guide. This should appear within a few moments.



Program Info (programme guide)

The programme guide is only available for channels which have been stored. The information it contains has been compiled by your television based on Teletext information transmitted by the various channels, according to the services they offer. It can be used to find out what programmes are on, to create a list of programmes you want to watch or record, to set a NexTView Link video recorder to record a programme or to automatically switch the television on when a particular programme starts.

The guide's availability and context depend entirely on the Teletext transmitted by each broadcaster. If the guide is not available on the channel you are watching, a message will inform you of this.

To access the programme guide:

- press the blue button, or
- display the **OVERVIEW** menu using the **MENU** button. Select **Program Info** and press **OK** to confirm.

The first page appears and the first programme on the list is the one that is showing at that moment.

Important: If the broadcasting company amends the pages on Teletext, your television will not be able to display the programme guide and the message "**Searching...**" will be displayed permanently on screen. If this happens, press **EXIT** to clear the message and refer to page 21 for instructions on how to save the new programme page.

The programme list is in the right half of the screen, the navigator in the left. Use the **<>** buttons to toggle between them.

You can use the navigator to carry out the following tasks:

Defining search criteria, such as day and period (time slot)

1. Use the **<** button to select the navigator.
2. Select one of the criteria using the **▲ ▼** buttons and press **OK** to confirm.
3. Select an option using the **<>** buttons. Press **OK** to confirm. The programme list appears.

Recording a programme

If you have connected a NexTView Link video recorder to the AV1 socket, the television will programme it automatically. To do this:

1. Insert a videocassette into the video recorder.
2. Choose the programme you wish to record, select **RECORD** from the navigator and press **OK** to confirm. The programme will appear in the **Review** screen.

Important:

- The time and date must be set on the television and video recorder.
- The video recorder must be switched on (not recording) or in standby mode. Follow the information given in the messages which appear indicating that programming is in progress.
- If you press **EXIT** when an error message appears, the video recorder will not be programmed.
- Once the programming process is complete, it can only be cancelled using the video recorder.

Storing a programme

This function is used to advise you that a programme is starting when you are watching another one.

1. Select the programme from the list.
2. Select **MEMO** from the navigator and press **OK** to confirm. The programme will appear in the **Review** screen.

Note: This function can only be used when the time and date have been set correctly.

Important:

- You can select up to 9 programmes to be stored/recorded.
- A message is displayed when the memory is full. You then have to delete a programme to be able to store or record another.
- A message also appears when the times of some of the programmes you plan to record or have stored overlap.



Checking your selections in the Review screen

The upper part of this screen contains the list of programmes set for recording, while the lower part contains the programmes stored for wake-up or to remind you when a programme is starting (memo list).

It appears automatically when you confirm the selection of a programme in the list. You can also display it by selecting **Review** from the navigator and pressing **OK** to confirm.

It provides access to the following functions:

Record: can be used to move a programme from the memo list to the recording list.

1. Select the programme you wish to record from the memo list.
2. Select **RECORD** from the navigator and press **OK** to confirm. The programme is then added to the recording list.

Notes:

- This function is only useful if you have a video recorder which has the NexTV Link function and is connected to an AVI socket. In this case, the television will automatically programme the video recorder.
- The instructions for use are the same as those given in the paragraph "Recording a programme" on the previous page.

Memo: can be used to store a programme from the recording list in the memo list.

1. Select the programme you wish to store from the recording list.
2. Select **MEMO** from the navigator and press **OK** to confirm. The programme is then added to the list of stored programmes.

You can now watch another channel, and a message appears informing you that the selected programme is about to start. Press the **EXIT** button to clear the message.

Wake-up: can be used to programme the TV set to come on when a stored programme or programme set for recording starts.

1. Select the programme from the list.
2. Select **WAKE-UP** from the navigator and press **OK** to confirm. The picture of an alarm clock appears beside the programme. The **Wake-up** function is enabled whenever you put your television in standby mode. Follow the same procedure to disable this function.

Clear: can be used to clear a programme from the list.

1. Select the programme from the list.
2. Choose **CLEAR** from the navigator and press **OK** to confirm.

Press **Return** to return to the **Program Info** screen. Press **EXIT** to quit the programme guide.

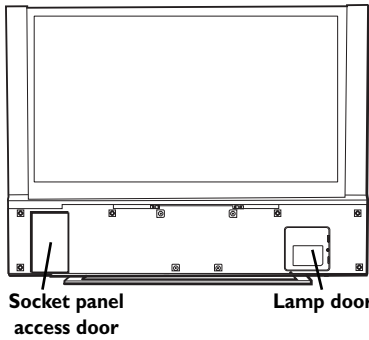

Removing the front panel piece

The front panel piece is removable to allow access to the socket panel and lamp door (for the lamp replacement, please refer to the separate leaflet).

To remove the front panel piece, grasp one end of the panel and pull out until the tab pops out of the hole. Continue to slide your fingers down the panel as the tabs pop out of place, until it is unattached.

Reattach the front panel piece by lining up the tabs with the holes, starting at the bottom. Then push the tabs back into place.

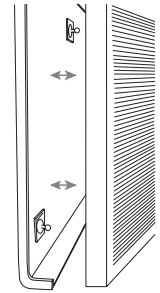

EN

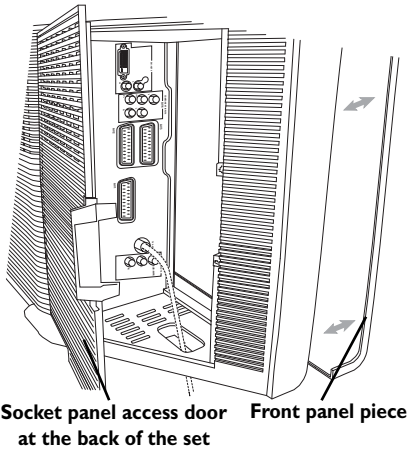

Sockets

Accessing the socket panel

The socket panel is located inside the front panel of the TV. You can access these sockets:

- either from the front of the set by removing the front panel piece as described above, if the set is hung using a wall mount assembly (available separately),
- or from the back by removing the socket panel door.

Locate the socket panel door on the back of the TV on the right bottom side. To remove the door, pull the tab towards the left, and then pull the door open. Reattach the socket panel door by fitting the tabs on the left into the slots and then close the door until it snaps into place.

Connect the cables to the sockets by putting the cables through the hole, as shown to the left. Then the cables can be placed on the shelf at the back of the TV.

AV1 and AV2 SCART sockets (input-output) inside the front panel

These sockets can be used to connect a range of equipment, including video recorders, camcorders (VHS, S-VHS, 8 mm or Hi 8), decoders, satellite receivers, DVD players, games consoles or devices producing an RGB signal.

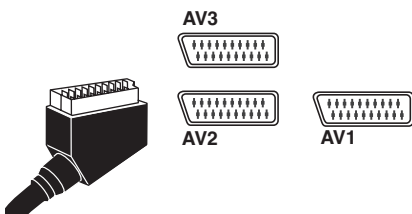

AV3 SCART socket (input) inside the front panel

This socket can be used to connect equipment, such as video recorders or camcorders (VHS, S-VHS, 8 mm or Hi 8).

AV4 CINCH audio and video component (synchroscan) sockets (input) inside the front panel

These can be used to connect a DVD player. The component sockets automatically detect the type of component signal received: interlaced component (Y/Pr/Pb) or progressive component (Y/Cr/Cb). The supported formats are:

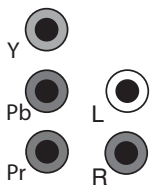

480i, 60Hz	576i, 50 Hz	1080i, 60 Hz	720p, 50 Hz
480p, 60 Hz	576p, 50 Hz	1080i, 50 Hz (31.25 kHz)	720p, 60 Hz
		1080i, 50 Hz (28.125 kHz)	

AV5 CINCH audio and DVI sockets (input) inside the front panel

These sockets can be used to connect a PC with a compatible graphics card, certain DVD players or a compatible high-definition digital satellite decoder. The DVI socket automatically detects whether a signal is received when you select the AV5 programme. The supported formats are:

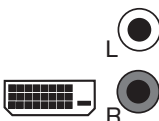

640 x 480p, 60 Hz, 16:9	1280 x 720p, 60Hz, 16:9
720 x 480p, 59,94 Hz, 16:9	1280 x 720p, 50Hz, 16:9
720 x 576p, 50 Hz, 16:9 (31.25 kHz)	1920 x 1080i, 60 Hz, 16:9 (33.75 kHz)
1080i, 50 Hz (28.125 kHz)	1920 x 1080i, 50 Hz, 16:9 (31.25 kHz)

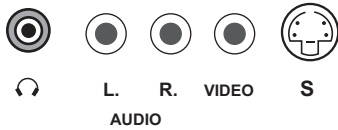
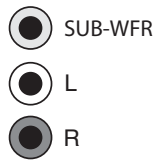

Audio CINCH sockets (output) inside the front panel

These can be used to connect a stereo amplifier, a hi-fi system or amplified speakers (see below).

AV3 audio and video CINCH sockets (input) at the front or side

These can be mainly used to connect camcorders (VHS or 8 mm format).

S socket and AV3 audio CINCH sockets (input) at the front or side

These can be mainly used to connect camcorders (S-VHS or Hi 8 format).

To display images using the equipment connected, press the **AV** button on the remote control: once to select AV1, twice to select AV2 and three times to select AV3. For some equipment (connected to the SCART sockets), this selection is done automatically.

Connecting headphones

Use the relevant socket on the front of the TV set to connect headphones or stereo earphones. Refer to page 12 on how to adjust the headphone volume.

Connecting active speakers

The audio CINCH sockets inside the front panel of the television can be used to connect active speakers (with a built-in amplifier) replacing the television's built-in speakers.

Left and right speakers: connect the left speaker to the CINCH L socket and the right speaker to the CINCH R socket.

Subwoofer: connect the subwoofer to the SUB-WFR socket.

Connecting an amplifier

You can connect an amplifier and 2 speakers to replace your television's side speakers: Connect your television's left L and right R CINCH sockets to the amplifier's L and R inputs. Configure the set as follows (see page 12):

Sound menu
Sound type: Stereo
Sound mode: Normal

Set menu
Left/Right speakers: External
Subwoofer: None

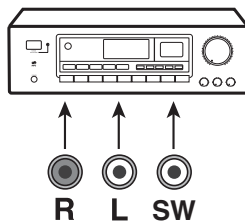

The television's side speakers and subwoofer are now disabled. Adjust the volume using the amplifier.

Connecting a video recorder

To obtain optimum picture quality, use a SCART cable. However, you can also connect a video recorder to the television using the aerial socket.



Refer to the diagram on the inside cover at the end of the manual, which illustrates how this is done.

If you connect a video recorder only via the aerial socket (without using the SCART socket), switch it on and play a tape.

Then use the **Auto-update** option of the **Installation** menu to search for the video recorder signal (refer to the Manual set-up section).

If you connect a video recorder via the aerial socket, you should assign channel 99 to it in order to improve the picture quality when tapes are being played and in pause mode. However, we recommend you connect your video recorder via the SCART socket, as it provides better picture and sound quality.

Other information

P L A Y I N G	Equipment	Video recorder 	Camcorder 
	Socket	Scart AV1	Scart or cinch AV3
R E C O R D I N G	Equipment	Video recorder or Camcorder	Video recorder or Camcorder
	Socket	Scart AV2	Scart AV2
	Call programme	AV1	AV3

Copying cassettes

Connect the VCR recording unit to the AV2 socket. Connect the playing unit:

- to the AV1 socket if a video recorder is being used,
- or to the AV3 SCART or front panel CINCH sockets if a camcorder is being used.

About NexTVView Link

NexTVView Link is an “intelligent” link, which can be used to set up channels and as an easy way to set programmes for recording on a video recorder with the NexTVView Link function or similar (Easy Link, Smart Link, Megalogic, etc.) from a television already set up. The video recorder should be connected to the AV1 socket using a Scart AVLink cable.

Important: If you've purchased your video recorder before 1997, it may not support the record feature.

Setting up channels

The NexTVView Link can be used to automatically download the terrestrial and cable channels already stored in the television to the video recorder. They will be arranged in the same order on both items of equipment.

Refer to the instructions for your video recorder to find out how this is done.

Setting a programme to record

The NexTVView Link function can also be used as an easy way of setting a programme to record from Program Info on your television (see paragraph “Recording a programme” on page 22).

Immediate recording

The NexTVView Link function can be used to record what you are currently watching. You simply press the relevant button on the video recorder remote control (usually REC) and the recorder will automatically switch to the same channel as the television and start recording.

Refer to the instructions for your video recorder to find out the relevant button to press and for more information on the subject.

Free Manuals Download Website

<http://myh66.com>

<http://usermanuals.us>

<http://www.somanuals.com>

<http://www.4manuals.cc>

<http://www.manual-lib.com>

<http://www.404manual.com>

<http://www.luxmanual.com>

<http://aubethermostatmanual.com>

Golf course search by state

<http://golfingnear.com>

Email search by domain

<http://emailbydomain.com>

Auto manuals search

<http://auto.somanuals.com>

TV manuals search

<http://tv.somanuals.com>