



TS 870

AUTOMATIC TRANSFER SWITCHES

INSTALLATION, OPERATING & SERVICE MANUAL

PM062 Rev 5 08/05/05

TABLE OF CONTENTS

1.	PRODUCT REVISION HISTORY	1
2.	EQUIPMENT STORAGE	1
2.1.	ENVIRONMENTAL CONDITIONS	1
3.	NOTES TO INSTALLER	2
3.1.	UPSTREAM CIRCUIT PROTECTIVE DEVICES/ELECTRICAL CONNECTIONS	2
3.2.	TRANSFER SWITCHES WITH INTEGRAL OVER CURRENT PROTECTION	3
3.3.	TRANSFER SWITCHES WITH MULTI-TAP VOLTAGE CAPABILITY	3
3.4.	SYSTEM PHASING-HIGH LEG DELTA SYSTEMS	4
3.5.	REMOTE START CONTACT FIELD WIRING	5
3.6.	DIELECTRIC TESTING	5
3.7.	INSTALLATION OF OPEN TYPE TRANSFER SWITCHES	5
4.	GENERAL DESCRIPTION	5
4.1.	PRODUCT MODEL CODE	7
4.2.	TYPICAL COMMISSIONING PROCEDURES	8
5.	GENERAL THEORY OF OPERATION	8
5.1.	STANDARD AUTOMATIC TRANSFER SWITCH	8
5.2.	SERVICE ENTRANCE AUTOMATIC TRANSFER SWITCH	9
5.3.	TEST MODES	13
6.	OVER CURRENT PROTECTION	13
6.1.	STANDARD TS 870 AUTOMATIC TRANSFER SWITCH	13
6.2.	OPTIONAL TS 870 AUTOMATIC TRANSFER SWITCH WITH INTEGRAL OVER CURRENT PROTECTION	13
7.	GENERAL NOTES ON SERVICING TRANSFER SWITCH MECHANISM	15
8.	TRANSFER SWITCH MECHANISM – 100A-800A, S STYLE	17
8.1.	MANUAL OPERATION	17

9. TRANSFER SWITCH MECHANISM –1000A-1200A, T-STYLE	19
9.1. MANUAL OPERATION	19
10. RECOMMENDED MAINTENANCE	21
11. FRONT VIEW (TYPICAL) 3 / 4 POLE 100A-250A S-STYLE TRANSFER MECHANISM	23
12. FRONT VIEW (TYPICAL) 3 POLE 400A-800A S-STYLE TRANSFER MECHANISM (MECHANISM FRONT COVER REMOVED)	24
13. FRONT VIEW (TYPICAL) 3 / 4 POLE 1000A-1200A T-STYLE TRANSFER MECHANISM	25
14. CONNECTION CONFIGURATION OPTIONS	26
15. CABLE TERMINAL INFORMATION	27
16. REQUIREMENTS FOR UPSTREAM CIRCUIT PROTECTIVE DEVICES	27
16.1. WITHSTAND CURRENT RATINGS (ALL MODELS WITHOUT INTEGRAL OVERCURRENT PROTECTION OPTION)	27
16.2. INTERRUPTING CAPACITY CURRENT RATINGS (ALL MODELS WITH INTEGRAL OVERCURRENT PROTECTION OPTION)	28
17. GROUND FAULT SITE TEST REQUIREMENTS	28
17.1. PERFORMANCE TEST	28
18. TROUBLESHOOTING	30
19. REPLACEMENT PARTS	32
20. PRODUCT RETURN POLICY	33
21. NOTES	34
22. PERFORMANCE TEST FORM	35

1. PRODUCT REVISION HISTORY

The following information provides an historical summary of changes made to this product since the original release.

Operating & Service Manual Version

Rev 0 04/11/19	Original release.
Rev 1 05/03/08	Changes to incorporate reversing style ATS Motor for 100-250A transfer switches.
Rev 2 05/05/26	Revisions to Section 8 and Section 18 .
Rev 3 06/05/08	Revisions to Section 15 .
Rev 4 07/07/31	Changes to Incorporate new S-Style 400A mechanism
Rev 5 08/03/05	Changes to Incorporate new S-Style mechanism (100A, 150A, 200A, 250A, 600A, 800A)

Contact Thomson Technology, to obtain applicable instruction manuals or if in doubt about any matter relating to installation, operation or maintenance. Soft copy of the most current version is available at www.thomsontechnology.com.

NOTE: All information contained in this manual is for reference only and is subject to change without notice.

2. EQUIPMENT STORAGE

The following procedures are required for correct storage of the transfer switch prior to installation.

2.1. ENVIRONMENTAL CONDITIONS

CAUTION!!!

Failure to store and operate equipment under the specified environmental conditions may cause equipment damage and void warranty.

2.1.1. EQUIPMENT STORAGE

The transfer switch shall be stored in an environment with a temperature range not exceeding -4° to +158° Fahrenheit (-20° to +70° Celsius) and a humidity range not exceeding 5%-95% non-condensing. Before storing, unpack sufficiently to check for concealed damage. If concealed damage is found, notify the ATS supplier and the Carrier immediately. Repack with the original, or equivalent packing materials. Protect from physical damage. Do not stack. Store indoors in a clean, dry, well

ventilated area free of corrosive agents including fumes, salt and concrete/cement dust. Apply heat as necessary to prevent condensation.

2.1.2. EQUIPMENT OPERATING

The transfer switch shall be operated in an environment with a temperature range not exceeding +5° to +122° Fahrenheit (-15° to +50° Celsius) and a humidity range not exceeding 5%-95% non-condensing.

3. NOTES TO INSTALLER

DANGER!!!!

Arc Flash and Shock Hazard. Will cause severe injury or death.

Do not open equipment until ALL power sources are disconnected

This equipment must be installed and serviced only by qualified electrical personnel utilizing safe work practices and appropriate Personal Protective Equipment (PPE). Failure to do so may cause personal injury or death

3.1. UPSTREAM CIRCUIT PROTECTIVE DEVICES/ELECTRICAL CONNECTIONS

To ensure satisfactory installation of this equipment be sure to observe "Cable Terminal Information" regarding power cable connection tightness and "Requirements for Upstream Circuit Protective Devices" located in this manual.

All mechanical and electrical connections must be checked for tightness prior to placing this equipment in service to ensure proper operation and to validate applicable warranty coverage.

3.2. TRANSFER SWITCHES WITH INTEGRAL OVER CURRENT PROTECTION

For models of transfer switch with integral over current protection, the over current protection must be set prior to operation. The equipment will be shipped from the factory with a long-time current setting of 100% (of the equipment rating) and maximum short-time/instantaneous current and time delay settings.

WARNING!

Do Not Energize this equipment until device settings have been verified to ensure proper system protection & coordination. Failure to do so may result in equipment failure.

Refer to **Section 5.2.2** of this manual for additional information on operation of the Transfer switch following an over current trip condition.

Refer to information supplied with the transfer switch documentation package for adjustment procedures on the power switching units over current protection trip unit. Contact the factory if any additional information is required.

3.3. TRANSFER SWITCHES WITH MULTI-TAP VOLTAGE CAPABILITY

If the transfer switch has programmable multi-tap voltage capability (i.e. ATS Model Code with Voltage Code "Y"), confirm the transfer switch has been configured for the correct system voltage prior to installation.

WARNING!

Failure to confirm and match transfer switch voltage with the system voltage could cause serious equipment damage.

The voltage selections and connections are shown on the engineered drawings attached to each transfer switch. The factory default settings will be indicated on the calibration label attached on the inside of the enclosure door (supplied loose on open style models). A blank label is included to record the applicable settings if the configuration is changed from the factory default settings.

To change the transfer switch voltage, refer to “**INSTRUCTIONS TO CHANGE SYSTEM VOLTAGE ON TS870 SERIES TRANSFER SWITCHES WITH TSC 80 CONTROLLER**” (attached as “**Appendix B**”). Contact Thomson Technology for further information as may be required.

3.4. SYSTEM PHASING-HIGH LEG DELTA SYSTEMS

For systems using high leg delta 240V 3 phase 4 wire systems, connection of supply conductors must have the correct phasing as shown below.

WARNING

Failure to match correct system phasing will result in serious damage to the TSC 80 controller.

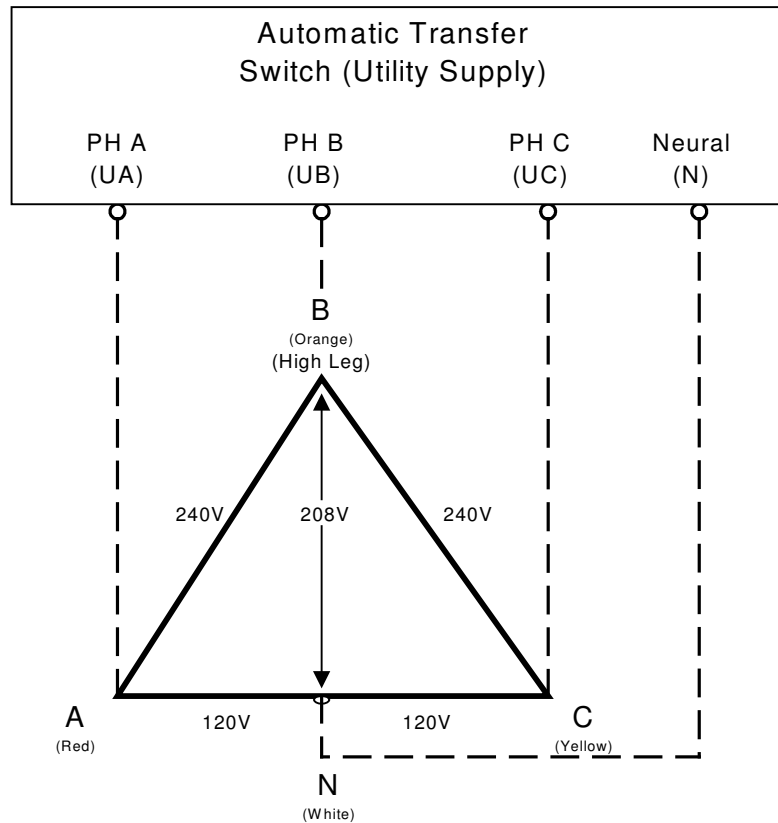

Where transfer switches are supplied without power isolation transformers (PT1 & PT2) for ATS control logic it is essential that the orientation of phase conductors of

the supply source be arranged such that the phase of highest potential with respect to ground is not connected to the power supply inputs to the controller (A Phase for both supplies). Failure to do so will result in equipment damage.

Per NEC Article 384-3 (f) "The B phase shall be that phase having the higher voltage to ground on a 3-phase, 4-wire delta connected systems."

3.5. REMOTE START CONTACT FIELD WIRING

As a minimum, the remote engine start control field wiring shall conform to the local regulatory authority on electrical installations. Field wiring of a remote start contact from a transfer switch to a control panel should conform to the following guidelines to avoid possible controller malfunction and/or damage.

3.5.1. Minimum #14 AWG (2.5mm²) wire size shall be used for distances up to 100ft (30m)¹). For distances exceeding 100 ft. (30m) consult Thomson Technology

3.5.2. Remote start contact wires should be run in a separate conduit.

3.5.3. Avoid wiring near AC power cables to prevent pick-up of induced voltages.

3.5.4. An interposing relay may be required if field-wiring distance is excessively long (i.e. greater than 100 feet (30m)) and/or if a remote contact has a resistance of greater than 5.0 ohms.

3.5.5. The remote start contact must be voltage free (i.e. dry contact). The use of a "powered" contact will damage the transfer controller.

3.6. DIELECTRIC TESTING

Do not perform any high voltage dielectric testing on the transfer switch with the TSC 80 controller connected into the circuit as serious damage will occur to the controller.

All AC control fuses and control circuit isolation plugs connected to the TSC 80 must be removed if high voltage dielectric testing is performed on the transfer switch.

3.7. INSTALLATION OF OPEN TYPE TRANSFER SWITCHES

Please refer to the factory for additional information.

4. GENERAL DESCRIPTION

Thomson Technology TS 870 series of Automatic Transfer Switches employ two mechanically interlocked enclosed contact power switching units and a microprocessor based controller to automatically transfer system load to a generator supply in the event of a utility supply failure.

System load is then automatically re-transferred back to the utility supply following restoration of the utility power source to within normal operating limits.

The standard TS 870 series Automatic Transfer Switch is rated for 100% system load and requires upstream over current protection. The TS 870 Automatic Transfer Switch may be supplied with optional integral over current protection within the enclosed contact power switching units for applications such as Service Entrance Rated equipment. Refer to [Section 6](#) of this manual for detailed information on over current protection.

The TS 870 series transfer switches use a type TSC 80 microprocessor based controller which provides all necessary control functions for fully automatic operation. The TSC 80 controller is mounted on the door of the transfer switch enclosure and operating status is shown via LED lights. For further information on the TSC 80 Transfer Controller, refer to separate instruction manual PM063.

The power switching devices used for the Utility and Generator sources are operated by an electrically driven motor mechanism in the transfer switch. The transfer switch motor utilizes the power from the source to which the electrical load is being transferred. The mechanism provides a positive mechanical interlock to prevent both power switching units from being closed at the same time, which allows an open transition, “break-before-make” transfer sequence. The TSC 80 transfer controller provides a standard neutral position delay timer to allow adequate voltage decay during transfer operation to prevent out of phase transfers.

Note: For the purpose of this manual, the following standard nomenclature is utilized:

- Utility: to indicate the source of primary power
- Generator: to indicate the source of standby power
- Power switching device: to indicate the transfer switch power switching device

4.1. PRODUCT MODEL CODE

The type of TS 870 series transfer switch supplied is identified by way of a 21 digit product code which appears on the equipment rating plate (MODEL) on the door of the transfer switch, and on the transfer switch drawings. The model code structure and definitions are as follows:

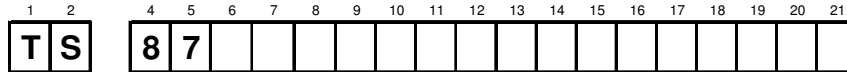

1-3. SERIES

TS - TRANSFER SWITCH

4 & 5. MODEL

87 - 870 SWITCH

6. POLES

- 2 - 2 POLE
- 3 - 3 POLE
- 4 - 4 POLE

7. CONFIGURATION TYPE

- A - ATS
- X - SPECIAL

8 - 11. AMPERAGE

- 0100
- 0150
- 0200
- 0250
- 0400
- 0600
- 0800
- 1000
- 1200

12. APPLICATION

- A - STANDARD
- B - SERVICE ENTRANCE
- X - SPECIAL

13. OPERATION TYPE

- 1 - OPEN TRANSITION
- 2 - MANUAL ELEC. OP.
- X - SPECIAL

14. SAFETY STANDARDS

- A - UL 1008
- B - CSA C22.2 NO 178
- X - NOT APPLICABLE

15. VOLTAGE

- 1φ 3 WIRE**
- D - 120/240
- 3φ 4 WIRE (GROUNDED NEUTRAL)**
- E - 120/208¹
- F - 127/220
- G - 120/240¹ (DELTA)
- H - 220/380²
- J - 240/416
- K - 254/440
- M - 277/480¹
- N - 347/600¹
- 3φ 3 WIRE**
- P - 208
- Q - 220
- R - 240
- S - 380²
- U - 416
- V - 480
- W - 600
- X - SPECIAL

16. CONTROLLER

- 1 - TSC80
- 3 - TSC 80e
- 7 - NONE (MANUAL)

17. ENCLOSURE TYPE

- A - NEMA1, ASA #61 GREY
- B - NEMA2, ASA #61 GREY
- C - NEMA12, ASA #61 GREY
- D - NEMA3R SD, ASA #61 GREY
- E - NEMA3R/4 DD, ASA #61 GREY³
- F - NEMA3RX/4X DD (306 STAINLESS STEEL)³
- G - NONE (OPEN STYLE)
- H - NEMA 3RXDD (ALUMINUM) ASA #61 GREY⁴
- X - SPECIAL

18. UTILITY SWITCHING DEVICE

- K - MOLDED CASE SWITCH (100 - 1200 A)
- M - MOLDED CASE SWITCH C/W THER-MAG TRIP (100-200A)
- N - MOLDED CASE SWITCH C/W ELECTRONIC TRIP (250-1200A)
- P - MOLDED CASE SWITCH C/W ELECTRONIC & GF TRIP (250-1200A)

19. GENERATOR SWITCHING DEVICE

- K - MOLDED CASE SWITCH (100 - 1200 A)
- M - MOLDED CASE SWITCH C/W THER-MAG TRIP (100-200A)
- N - MOLDED CASE SWITCH C/W ELECTRONIC TRIP (250-1200A)
- P - MOLDED CASE SWITCH C/W ELECTRONIC & GF TRIP (250-1200A)

20. POWER CONNECTIONS

- A - STANDARD
- X - SPECIAL

21. ATS CONNECTION CONFIGURATION

- A - STANDARD
- B - ALTERNATE B (1000-1200A)
- C - ALTERNATE C (1000-1200A)
- D - ALTERNATE D (1000-1200A)

REFER TO DRAWING #870M100

NOTES

- ¹ MULTI-VOLTAGE CAPABLE
- ² FOR 50 Hz APPLICATION
- ³ STANDARD ENCLOSURE RATING IS N3R AT 800A AND ABOVE AND N4 AT 600A AND BELOW
- ⁴ ONLY AVAILABLE 800A AND ABOVE

4.2. TYPICAL COMMISSIONING PROCEDURES

CAUTION:

Commissioning procedures must be performed by qualified personnel only. Ensure the Automatic Transfer Switch (ATS) Control Circuit Isolation Plug is disconnected prior to energizing the supply sources. Manually place the transfer switch mechanism in the neutral position prior to applying power. Failure to do so may result in equipment failure or personal injury.

Note: The **TYPICAL AUTOMATIC TRANSFER SWITCH COMMISSIONING PROCEDURES MODEL SERIES TS 870** (attached as “**Appendix A**”) is provided for general information only pertaining to typical site installations and applications. Contact Thomson Technology for further information as may be required.

Note: An optional hand held, plug-in Service Display Module (SDM) is available for the TSC 80 Transfer Controller. The SDM module provides an LCD screen to display additional detailed information on the operation and settings of the TSC 80 controller for simplified servicing/trouble shooting procedures. For detailed information, refer to the separate SDM module instruction manual (PM065).

5. GENERAL THEORY OF OPERATION

5.1. STANDARD AUTOMATIC TRANSFER SWITCH

5.1.1. NORMAL OPERATION

When utility supply voltage drops below a preset nominal value (adjustable from 70% to 100% of nominal) on any phase, an engine start delay circuit is initiated and the transfer to utility supply signal will be removed (i.e. contact opening). Following expiry of the engine start delay period (adjustable from 0 to 60 sec.) an engine start signal (contact closure) will be given.

Once the engine starts, the transfer switch controller will monitor the generator voltage and frequency levels. Once the generator voltage and frequency rises above preset values (adjustable from 70% to 95% of nominal), the engine warm-up timer

will be initiated. Once the warm-up timer expires (adjustable from 0 to 60 sec.), the Transfer to Generator Supply signal (contact closure) will be given to the transfer switch mechanism. The load will then transfer from the utility supply to the generator supply via the motor driven mechanism.

The generator will continue to supply the load until the utility supply has returned. The retransfer sequence is completed as follows: when the utility supply voltage is restored to above the preset values (adjustable from 70% to 95% of nominal) on all phases, a transfer return delay circuit will be initiated. Following expiry of the Utility Return Timer (adjustable from 0 to 30 min.), the Transfer to Generator Supply signal will be removed (contact opening), then the Transfer to Utility Supply signal (contact closure) will be given to the transfer switch mechanism. The load will then retransfer the load from the generator supply back to the utility supply. **Note:** A neutral delay timer circuit will delay the transfer sequence in the neutral position (i.e. both power switching devices open) until the neutral delay time period expires (adjustable from 0 to 60 seconds).

An engine cooldown timer circuit will be initiated once the load is transferred from the generator supply. Following expiry of the cooldown delay period (adjustable from 0 to 30 minutes), the engine start signal will be removed (contact opening) to initiate stopping of the generator set.

5.2. SERVICE ENTRANCE AUTOMATIC TRANSFER SWITCH

Note: This applies only to service entrance transfer switches

5.2.1. NORMAL OPERATION

Under normal conditions, the load is energized from the utility supply through the closed utility transfer power switching device. If the utility power fails, the generator will start and the load will be re-energized via the closed generator transfer power switching device.

In the normal operating mode, the Service Disconnect switch shall be in the “energized” position.

5.2.2. OVER CURRENT TRIP

Should the utility power switching device trip open due to an over current condition, TSC 80 transfer controller will initiate an engine start signal and will permit transfer of

the load to the generator supply. The utility source will be locked out and the load will remain on the generator supply until the TSC 80 alarm signal is manually reset. Refer to the TSC 80 Instruction Manual for further details on Transfer Fail operation.

Should the generator power switching device trip open due to an over current condition, TSC 80 transfer controller will initiate transfer of the load to the utility supply. The generator source will be locked out and the load will remain on the utility supply until the TSC 80 alarm signal is manually reset.

5.2.3. SERVICE DISCONNECT PROCEDURE

To perform a service disconnect (i.e. to disconnect the utility and generator supplies), the following procedure is required:

1. Move the "Service Disconnect" control switch located on the door of the transfer switch to the "Disconnected" position.
2. Verify that the "Service Disconnected" pilot light is illuminated. *If the Light is illuminated, the service has been successfully disconnected and it is safe to perform any maintenance procedures as required.* In this condition, the transfer switch is in the neutral position, with both utility and generator transfer power switching devices open. The transfer switch will remain in this condition, regardless of condition of the utility and generator supplies (i.e. if the utility power fails, the generator will not receive a start signal, nor will the transfer switch move to the generator position). NOTE: *If the Service Disconnect Light is **not** illuminated, additional procedures are required (refer to the following procedure #5.2.4).*
3. Attach safety lockout padlock to the "Service Disconnect" control switch to prevent unauthorized change in operating condition and verify transfer switch door is locked closed. If the door is not locked, turn and remove door key.

WARNING!

Close and lock the transfer switch enclosure door before connecting power sources.

4. To reenergize the load, remove the padlock(s) from the service disconnect control switch, and move the switch to the energized position. The transfer

switch will immediately return to the utility or generator supply if within normal operating limits.

5.2.4. ADDITIONAL PROCEDURES

If the "Service Disconnected" pilot light is **not** illuminated, the service will **not** have been successfully disconnected and therefore it is **not** safe to perform any maintenance until the following additional procedures are performed:

DANGER!!!!

Arc Flash and Shock Hazard. Will cause severe injury or death.

Do not open equipment until ALL power sources are disconnected

This equipment must be installed and serviced only by qualified electrical personnel utilizing safe work practices and appropriate Personal Protective Equipment (PPE). Failure to do so may cause personal injury or death

1. Open the door to the transfer switch using a suitable tool and opening the door lock with the key.
2. Visually inspect the actual position of the transfer switch mechanism. *If the position of the transfer switch mechanism is clearly in the "neutral position" and the load bus is de-energized on all phases, the service has been successfully disconnected.* Proceed to Step. 4.

If the position of the transfer switch mechanism is not in the neutral position or the load bus is energized, further procedures are required.

Note: If the position of the transfer switch mechanism is clearly in the "neutral position, the "service disconnected" pilot light may not have illuminated due to the following reasons:

- a) Utility and generator supply voltages are not present (the pilot light requires AC supply voltage to be present).
- b) The pilot light may be burnt out. The bulb should be immediately replaced with a suitably rated bulb.
- c) Failure of one or more of the sensing/logic contacts. A qualified service technician is required to trouble shoot this specific condition. Switch the utility control circuit isolation switch to the de-energized position

to remove utility control power. To isolate the generator supply, remove the control circuit isolation plug. **Note:** The AC power conductors will still remain energized. Once all the control circuits are de-energized and isolated the "Service Disconnected" pilot light will not illuminate due to loss of control power.

Note: To return the transfer switch back to normal operation, the utility control circuit disconnect switch and control circuit isolation plug must be switched on and reconnected for correct operation.

3. If the position of the transfer switch mechanism is **not** in the "neutral position", manually operate the transfer switch mechanism depending on mechanism type as follows:

Note: Refer to product drawings in sections 12, 13 & 14 for identification of Transfer Switch Mechanism style supplied with the Transfer Switch.

- a. **T-Style Mechanism:** Pull the manual release plunger on the mechanism, releasing the motor drive rod from motor drive arm and move the knob and yoke to the marked "neutral position".
- b. **S-Style Mechanism:** Insert the operating handle into the front of the transfer mechanism and turn the operating handle until the position indication on the mechanism clearly shows the "neutral position".

WARNING!

Failure to move the mechanism to the Neutral Position may result in serious personal injury or death due to electrical shock.

4. Close the transfer switch door securely using a suitable tool. Lock the door in the closed position and remove the key.

WARNING!

Failure to positively lock closed and secure the transfer switch door may result in serious personal injury or death due to electrical shock.

5. Attach a safety lockout padlock to the service disconnect control switch to prevent unauthorized change in operating condition and verify transfer switch door is locked closed.
6. To reenergize the load, remove the padlock(s) from the service disconnect control switch, and move the switch to the Energized position. The transfer switch will immediately return to the utility or generator supply if within normal operating limits.

5.3. TEST MODES

The transfer switch may be tested utilizing the TSC 80 controller push-buttons or optional four position test switch. A simulated utility power failure condition will be activated when the test mode is selected. The transfer switch will operate as per a normal utility power fail condition.

The transfer switch will remain on generator supply until the test mode is terminated. It will then immediately transfer back to the utility supply and then continue to operate the generator set for its cooldown period then stop. **Note:** The transfer switch will automatically return to the utility supply (if within nominal limits) if the generator set fails while in the test mode.

6. OVER CURRENT PROTECTION

Thomson Technology **TS 870** series of Automatic Transfer Switches may be supplied with or without integral over current protection as described below:

6.1. STANDARD TS 870 AUTOMATIC TRANSFER SWITCH

The standard TS 870 Automatic Transfer Switch does not contain any integral over current protection and requires upstream over current protection devices for both Utility and Generator sources. The Standard TS 870 is rated for 100% continuous loading and can withstand a maximum short circuit fault current as noted in [Section 15](#) of this manual. The standard TS 870 transfer switch model without integral over current protection is identified in the product model code. Refer to [Section 4.1](#) of this manual for further details on model coding.

6.2. OPTIONAL TS 870 AUTOMATIC TRANSFER SWITCH WITH INTEGRAL OVER CURRENT PROTECTION

TS 870 transfer switches will have integral over current protection supplied on the Utility source as standard. The type of over current protection utilized is dependent upon ATS amperage size and optional features specified. For transfer switches rated 100A through

200A, over current protection is non-adjustable thermal-magnetic type trip units. For transfer switches rated 400A through 1200A over current protection is adjustable electronic type with long time & instantaneous trip unit elements with optional ground fault protection elements.

Note: Ground fault protection is supplied as standard on 1000A and 1200A transfer switches that are used on systems greater than 240V.

An upstream over current protection device is required on the generator source which feeds the TS 870 Transfer Switch if integral over current protection option is not specified on the ATS.

Note: For models of transfer switch with adjustable integral over current protection trip units, the over current protection must be set prior to operation. The equipment will be shipped from the factory with a long-time current setting of 100% (of the equipment rating) and maximum instantaneous/short-time current and time delay settings.

WARNING!

Do Not Energize this equipment until device settings have been verified to ensure proper system protection & coordination. Failure to do so may result in equipment failure.

Refer to [Section 4.1](#) Product Model Code for types of integral over current protection which are supplied with the transfer switch.

7. GENERAL NOTES ON SERVICING TRANSFER SWITCH MECHANISM

DANGER!!!!

Arc Flash and Shock Hazard. Will cause severe injury or death.

Do not open equipment until ALL power sources are disconnected

This equipment must be installed and serviced only by qualified electrical personnel utilizing safe work practices and appropriate Personal Protective Equipment (PPE). Failure to do so may cause personal injury or death

Note: Refer to product drawings in sections 12, 13 & 14 for identification of Transfer Switch Mechanism style supplied with the Transfer Switch.

When performing any service work on the transfer mechanism, it is imperative that the following be observed:

- 7.1. To maintain mechanical integrity, ensure that:
 - On T Style mechanisms, all limit switches are correctly adjusted to provide full travel of the power switching device toggles *without* exerting unnecessary forces associated with excessive travel. Ensure that power switching device travel far enough to reset any internal trip unit (it is more important for the toggle to go fully in the "off" direction, than in the "on" direction).
 - Mechanical interlocking is correct when one power switching opens well before the other should close.
 - All fasteners are adequately tightened.
 - The operating linkages are not damaged or bent, and that all bearing points operate freely.
 - On S style transfer switch mechanisms, check nylock nuts on bolt pivot points. Operation arms should move freely without excessive play.
- 7.2. To maintain electrical integrity, ensure that:
 - All electrical connections, especially power connections, are clean and adequately tightened. Corroded or loose power connections will cause destructive heating, and may cause premature tripping.
 - All insulating devices are in place and in good condition.

- No moisture or other contamination is present.
 - Electrical conductors are adequately secured away from moving parts.
- 7.3.** To maintain operational integrity, ensure that:
- All control devices are in good condition and correctly calibrated.
 - All control devices are adequately secured in their plug-in fixtures.

Only qualified personnel should undertake Service work. Failure to correctly maintain an automatic transfer switch may present a hazard to life and equipment. Full operational testing must be done prior to placing a transfer switch in service subsequent to any maintenance or repair. Any service work involving electrical components requires high-potential testing to ensure that required insulation levels have been maintained.

8. TRANSFER SWITCH MECHANISM – 100A-800A, S Style

The transfer mechanism consists primarily of the transfer gear motor, a drive hub assembly, and two power switching device operating arms.

The reversible transfer gear motor drives the drive hub assembly, which in turn moves the power switching device operating arms. The power switching device toggles are set inside the operating arm slots and are moved by them. There are two limit switches, which are contacted by the operating arms (one for each power switching device), which disconnect the transfer motor power supply when the power switching devices have attained full travel. Should limit switch adjustment be required, it is advisable to consult Thomson Technology for further information.

The transfer switch mechanism has three possible positions:

- a) Utility power switching device closed and generator power switching device open;
- b) Generator power switching device closed and utility power switching device open;
- c) Both utility and generator power switching devices open, but **NEVER** both utility and generator power switching devices closed at the same time.

8.1. MANUAL OPERATION

DANGER!!!!

Arc Flash and Shock Hazard. Will cause severe injury or death.

Do not open equipment until ALL power sources are disconnected

This equipment must be installed and serviced only by qualified electrical personnel utilizing safe work practices and appropriate Personal Protective Equipment (PPE). Failure to do so may cause personal injury or death

Isolate the transfer switch from all sources of supply before opening the enclosure for manual operation. With all sources of power de-energized to the transfer switch, the control circuit isolation plug can be unplugged to prevent subsequent operation. The control circuit isolation plug is located on the inner side of the transfer switch enclosure door.

To operate manually, insert the operating handle into the square hole on the front of the mechanism and rotate to the desired position. Remove the operating handle once operation is complete and re-insert into the handle holder on the left-hand side of the transfer switch mechanism.

Automatic operation may be regained by replacing the control circuit isolation plug. With all sources of power de-energized to the transfer switch, the control circuit isolation plug can be re-connected. The drive system will operate the transfer switch to the required position. (See manual operation instruction on front of transfer switch mechanism.)

9. TRANSFER SWITCH MECHANISM –1000A-1200A, T-Style

The transfer mechanism consists primarily of the transfer motor, a hub assembly, two operating rods and two power switching device operating yokes.

The reversible transfer motor drives the hub assembly, which in turn moves the operating rods that are connected to the power switching device operating yokes. The power switching device toggles are set inside the yokes and are moved by them. There are two limit switches, which are contacted by the operating yokes (one for each direction of travel), which disconnect the transfer motor power supply when the power switching devices have attained full travel. The adjuster screws, located on the yokes determine the operating point of these limit switches. Should adjustment be required, it is advisable to consult Thomson Technology for further information.

The transfer switch mechanism has three possible positions:

- a) Utility power switching device closed and generator power switching device open;
- b) Generator power switching device closed and utility power switching device open;
- d) Both utility and generator power switching devices open, but NEVER both utility and generator power switching devices closed at the same time.

9.1. MANUAL OPERATION

DANGER!!!!

Arc Flash and Shock Hazard. Will cause severe injury or death.

Do not open equipment until ALL power sources are disconnected

This equipment must be installed and serviced only by qualified electrical personnel utilizing safe work practices and appropriate Personal Protective Equipment (PPE). Failure to do so may cause personal injury or death

Isolate the transfer switch from all sources of supply before opening the enclosure for manual operation. With all sources of power de-energized to the transfer switch, the control circuit isolation plug can be unplugged to prevent subsequent operation.

To operate manually, pull the release plunger and operate the handle in the desired direction.

Automatic operation may be regained by replacing the isolation plug. With all sources of power de-energized to the transfer switch, the control circuit isolation plug can be re-

connected. The drive system is self-engaging and will operate the transfer switch to the required position. (See manual operation instruction on front of transfer switch mechanism.)

10. RECOMMENDED MAINTENANCE

DANGER!!!!

Arc Flash and Shock Hazard. Will cause severe injury or death.

Do not open equipment until ALL power sources are disconnected

This equipment must be installed and serviced only by qualified electrical personnel utilizing safe work practices and appropriate Personal Protective Equipment (PPE). Failure to do so may cause personal injury or death

- 10.1. DO NOT perform dielectric tests on the equipment with the control components in the circuit.
- 10.2. Check if control components are tight in sockets.
- 10.3. Periodically inspect all terminals (load, line and control) for tightness. Re-torque all bolts, nuts and other hardware. Clean or replace any contact surfaces, which are dirty, corroded or pitted.
- 10.4. Transfer switches should be in a clean, dry and moderately warm location. If signs of moisture are present, dry and clean transfer switch. If there is corrosion, try to clean it off. If cleaning is unsuitable, replace the corroded parts. Should dust and/or debris gather on the transfer switch, brush, vacuum, or wipe clean. DO NOT blow dirt into power switching devices.
- 10.5. Test the transfer switch operation. While the unit is exercising, check for freedom of movement, hidden dirt, corrosion or any excessive wear on the mechanical operating parts. Ensure that the power switching device travel is correct.
- 10.6. Verify all program settings on the TSC 80 controller as per the TSC 80 component calibration label on the rear cover of the controller.
- 10.7. Transfer Mechanism 1000A-1200A-T Style ensure that the manual handle moves freely on the hub when the lock pin is disengaged. If lubrication is necessary, apply medium weight (SAE 20) oil sparingly.
- 10.8. Transfer Mechanism 1000A-1200A T Style -yoke pivot bearings and rod ends are permanently lubricated and do not require maintenance.
- 10.9. Transfer Mechanism 100A-800A S Style –lubrication of drive hub/operator arm interface. Use high viscosity moly lubricant.

10.10. The motor and gearbox on all Transfer Mechanism styles are permanently lubricated, and should not require attention under normal operating circumstances.

11. FRONT VIEW (TYPICAL) 3 / 4 POLE 100A-250A S-Style TRANSFER MECHANISM

NOTE 1: 3 PHASE CONNECTION SHOWN. FOR SINGLE PHASE CONNECT TO A & B ONLY

NOTE 2: CONTROL CIRCUIT ISOLATION PLUG IS LOCATED ON INSIDE OF ENCLOSURE DOOR.

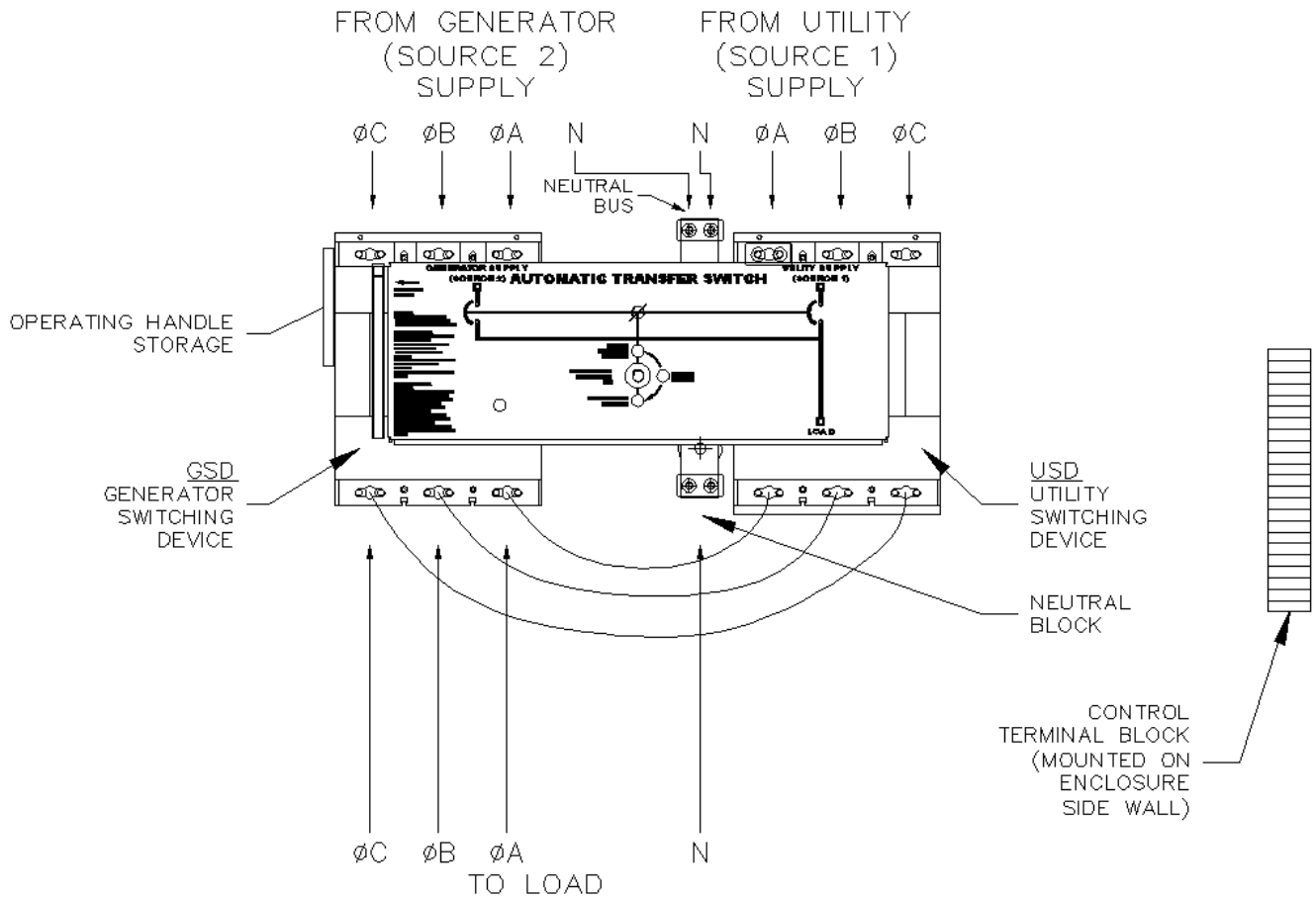

12. FRONT VIEW (TYPICAL) 3 POLE 400A-800A S-Style TRANSFER MECHANISM (Mechanism Front Cover Removed)

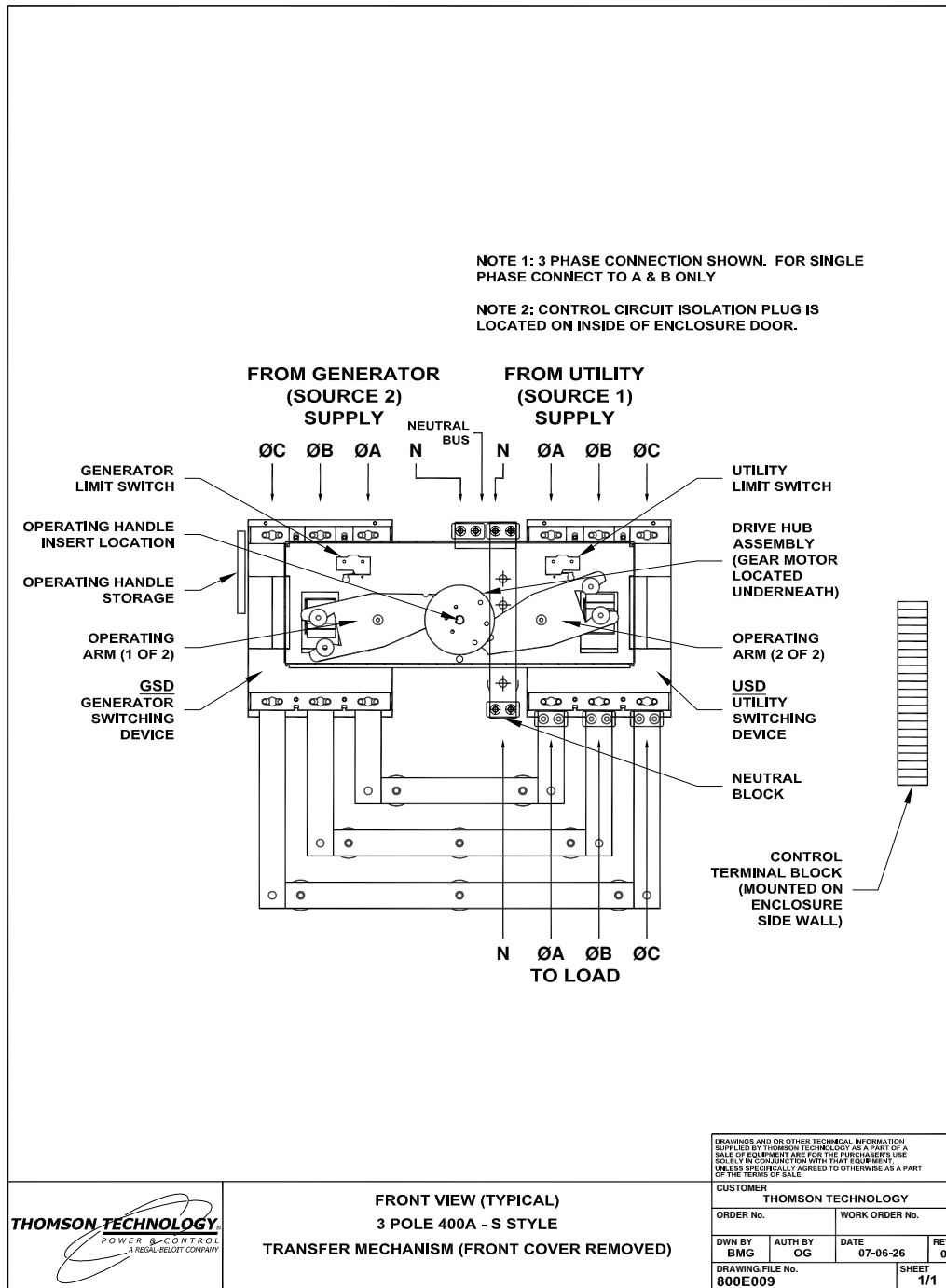

13. FRONT VIEW (TYPICAL) 3 / 4 POLE 1000A-1200A T-Style TRANSFER MECHANISM

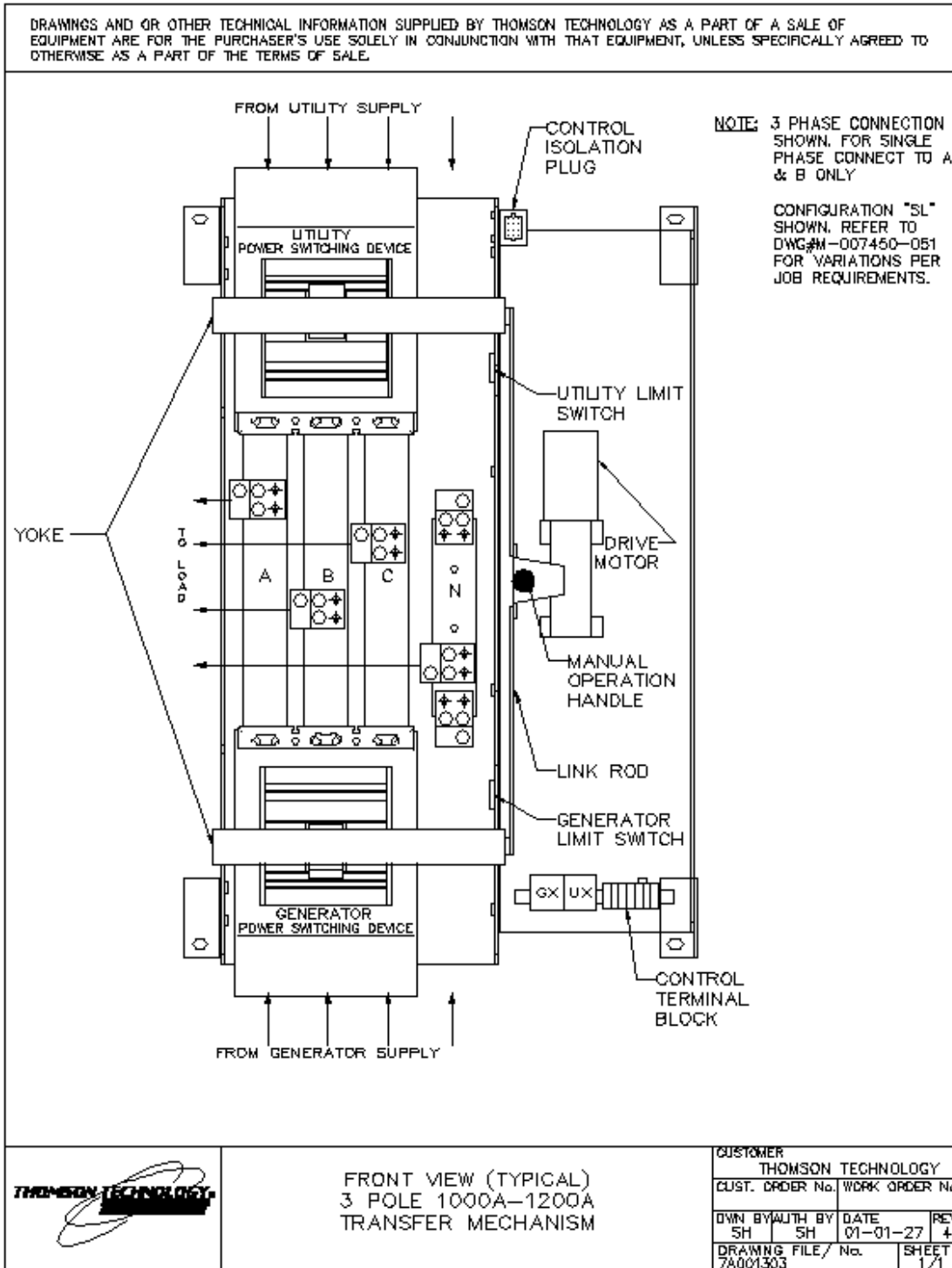

© THE INFORMATION ON THIS DRAWING IS THE PROPERTY OF THOMSON TECHNOLOGY. IT IS NOT TO BE USED DIFFERENTIALLY TO OUR INTERESTS.

14. CONNECTION CONFIGURATION OPTIONS

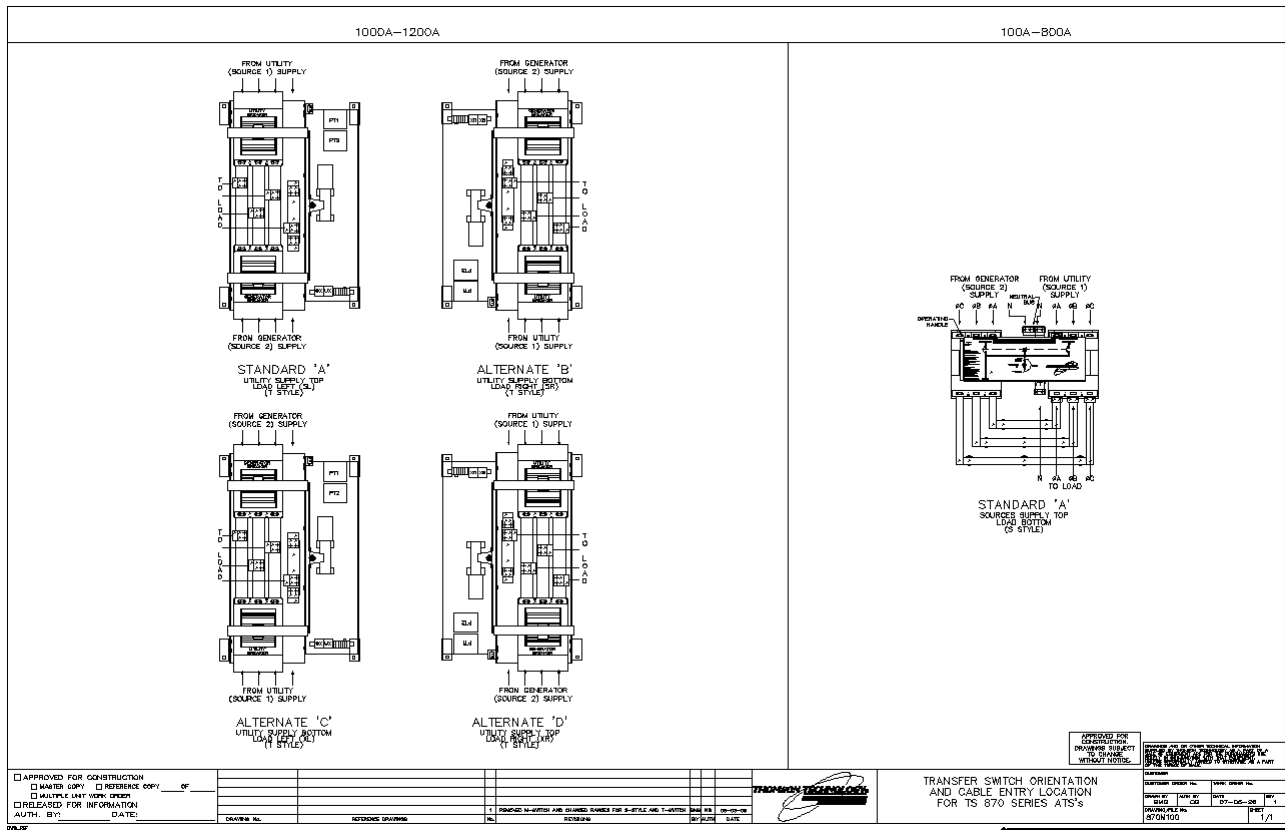

15. CABLE TERMINAL INFORMATION

BASIC MODEL	TERMINAL RATING		CONNECTION TIGHTNESS (In-lbs)	
	QTY PER PHASE	RANGE	TERMINAL MOUNTING SCREW	CABLE CLAMP
TS 87xA-0100	1	#14-1/0	120	50
TS 87xA-0150	1	#2-4/0	120	120
TS 87xA-0200	1	#6-350MCM	150	275
TS 87xA-0250	1	#6-350MCM	150	275
TS 87xA-0400 ¹	2	2/0-500MCM	72	275
TS 87xA-0600 ¹	2	2/0-500MCM	72	275
TS 87xA-0800 ¹	3	2/0-500MCM	110	375
TS 87xA-1200 ¹	4	4/0-500MCM	375	375

- Optional terminal ratings are available in some models – Consult Thomson Technology.
- For other model types not shown, contact Thomson Technology for further information.

16. REQUIREMENTS FOR UPSTREAM CIRCUIT PROTECTIVE DEVICES

16.1. WITHSTAND CURRENT RATINGS (ALL MODELS WITHOUT INTEGRAL OVERCURRENT PROTECTION OPTION)

BASIC MODEL	MAX. VOLTAGE	RATED CURRENT (A)	WITHSTAND CURRENT RATING AMPS (RMS) ¹				
			With Upstream Circuit Breaker Protection			With Upstream Fuse Protection	
			@240V	@480V	@600V	@ Up to 600V	Fuse Type
TS87xA-0100	600	100	65,000	25,000	18,000	100,000	T, J
TS87xA-0150	600	150	65,000	25,000	18,000	100,000	T, J
TS87xA-0200	240	200	65,000	N/A	N/A	N/A	T, J
TS87xA-0250	600	250	65,000	35,000	25,000	100,000	T, J
TS87xA-0400	600	400	65,000	50,000	35,000	100,000	T, J
TS87xA-0600	600	600	65,000	50,000	35,000	100,000	T, J
TS87xA-0800	600	800	65,000	50,000	35,000	100,000	Consult Factory
TS87A-1000/1200	600	1000/1200	65,000	50,000	42,000	100,000	Consult Factory

- Standard ratings only are shown. Consult Thomson Technology for versions with higher withstand current ratings.
- For other model types not shown, contact Thomson Technology for further information.

Fuse ratings shown are maximum allowable to permit use of the transfer switch in application with available fault current not exceeding that shown. Consideration must be given to fuse sizing when fuses also provide overload protection.

16.2. INTERRUPTING CAPACITY CURRENT RATINGS (ALL MODELS WITH INTEGRAL OVERCURRENT PROTECTION OPTION)

BASIC MODEL	MAX. VOLTAGE	RATED CURRENT (A)	INTERRUPTING CAPACITY CURRENT RATING AMPS (RMS) ₁		
			No Upstream Circuit Breaker Protection Required		
			@240V	@480V	@600V
TS87xA-0100	600	100	65,000	25,000	14,000
TS87xA-0150	600	150	65,000	25,000	14,000
TS87xA-0200	240	200	65,000	N/A	N/A
TS87xA-0250	600	250	65,000	35,000	22,000
TS87xA-0400	600	400	65,000	50,000	25,000
TS87xA-0600	600	600	65,000	50,000	25,000
TS87xA-0800	600	800	65,000	50,000	25,000
TS88xA-1000/1200	600	1000/1200	65,000	50,000	50,000

1. Standard ratings only are shown. Consult Thomson Technology for versions with higher interrupting capacity current ratings.
2. For other model types not shown, contact Thomson Technology for further information.

17. GROUND FAULT SITE TEST REQUIREMENTS

Per NEC and UL1008, a ground fault protected system shall be performance tested when first installed on site. A written record of this shall be made and be available to the authority having jurisdiction. A form is provided at the back of this manual for this purpose – see **Section 21**.

Confirm and record actual trip setpoints in the form provided which is to be made available on request by inspection authority.

17.1. PERFORMANCE TEST

Qualified Field Service technicians require a calibrated current injection test apparatus and must be knowledgeable in breaker testing to provide primary neutral CT injection up to or greater than the trip setpoint as selected by the responsible party. As indicated in the NEC, the maximum setting of the ground fault protection shall be 1200 amps, and the maximum time delay shall be 1 second for ground faults equal to or greater than 3000 amps.

The inspection authority should be contacted to confirm actual test requirements as these may vary by region or local code requirements.

The interconnected system shall be evaluated to ensure compliance with the appropriate schematic drawings. The proper location of sensors and power cabling shall be determined. The grounding points of the system shall be verified to determine that ground paths do not exist that would bypass the sensors. The use of high-voltage testers and resistance bridges may be required. A simulated fault current is to be generated by a coil around the sensors. The reaction of the circuit-interrupting device is to be observed for correct response. The results of the test are to be recorded on the test form provided.

18. TROUBLESHOOTING

DANGER!!!!

Arc Flash and Shock Hazard. Will cause severe injury or death.

Do not open equipment until ALL power sources are disconnected

This equipment must be installed and serviced only by qualified electrical personnel utilizing safe work practices and appropriate Personal Protective Equipment (PPE). Failure to do so may cause personal injury or death

Note: An optional hand held, plug-in Service Display Module (SDM) is available for the TSC 80 Transfer Controller. The SDM module provides an LCD screen to display additional detailed information on the operation and settings of the TSC 80 controller for simplified servicing/trouble shooting procedures. For detailed information, refer to the separate SDM module instruction manual (PM065).

Symptom	Possible Causes
Will not re-transfer to utility source upon restoration	<ul style="list-style-type: none"> - Isolation plug out - Utility disconnect switch is in the de-energized position (Service Entrance Rated ATS). Switch to the Energized position. - A test mode has been activated (check TSC 80 status LED) - Utility voltage is below the pre-programmed limits (check utility source for adequate voltage) - A loose control connection - Faulty motor limit switch - Defective motor - TSC 80 has incorrect voltage configuration jumper setting for correct system voltage - Defective TSC 80 controller (verify output signals with circuit board mounted diagnostic LED's) - TSC 80 has "Transfer Fail" alarm activated as indicated by flashing Load on Utility LED. Determine cause of alarm and rectify before TSC 80 is reset
Will not transfer to generator source upon failure of utility source	<ul style="list-style-type: none"> - Isolation plug out - Generator set not producing enough voltage/frequency or output circuit breaker open - TSC 80 has incorrect voltage configuration jumper setting for correct system voltage - Warm-up time delay function has not timed out yet (verify TSC 80 timer setting) - A loose control connection - Faulty motor limit switch - Defective motor

	<ul style="list-style-type: none"> - Defective TSC 80 controller (verify output signals with circuit board mounted diagnostic LED's) - TSC 80 has "Transfer Fail" alarm activated as indicated by flashing Load on Generator LED. Determine cause of alarm and rectify before TSC 80 is reset
Transfer to generator source without a power failure in the utility source	<ul style="list-style-type: none"> - A test mode has been activated (check TSC 80 status LED) - Utility supply voltage is slightly below voltage sensing setpoints. Verify TSC 80 has correct voltage configuration jumper setting for system voltage - Defective TSC 80 controller (verify output signals with circuit board mounted diagnostic LED's) - Utility power switching device has tripped due to an over current condition and TSC 80 "Transfer Fail" alarm activated as indicated by flashing Load on Utility LED. Determine cause of alarm and rectify before TSC 80 is reset.
Generator does not start up or stop when it should	<ul style="list-style-type: none"> - Verify remote engine control panel is set for automatic mode
No time delay when there should be	<ul style="list-style-type: none"> - Verify time delay setting of the TSC 80 controller
Power is not available at the load terminals but the utility or generator power switching device appears to be closed to a live source	<ul style="list-style-type: none"> - The power switching device's over current protection unit has opened due to a fault on the system. Correct the fault, and manually reset the power switching device in the transfer switch by moving it off and then on again with the manual operating handle - Limit switch incorrectly adjusted
The transfer switch has completed a transfer, but the motor has overheated and the internal thermal protector has opened	<ul style="list-style-type: none"> - Limit switch failure or improper adjustment has failed to disconnect motor - Binding or jamming of the transfer mechanism

NOTE

There are no user serviceable components located on the TSC 80 printed circuit board. If the TSC 80 controller is deemed to be defective it must be returned to the Thomson Technology Factory for repair or replacement. Please refer to Product Return Policy section of this manual further information on product return procedures required.

19. REPLACEMENT PARTS

Replacement parts are available for the transfer switch as follows:

NOTE

When ordering replacement parts please provide the following information:

- Transfer Switch Model code (e.g. TS 873AA0200AS)
- Transfer Switch Serial Number (e.g. W-022345)

The above information can be found on the transfer switch equipment rating plate located on the outside of the ATS door.

Component Description	Thomson Technology Part Number	Comments
TSC 80 Service Replacement Controller Board c/w lexan	TSC80SR	Must set configuration Jumper prior to use. Refer to TSC 80 Instruction Manual.
TSC 80 Lexan Faceplate	005336	Contact Thomson Technology Service Dept for installation procedures.
TSC 80 Rear Cover	005707	
Limit Switch 1 n/o, 1 n/c (all ATS Models)	004929	Must install and adjust for proper operation before use. Contact Thomson Technology Service Dept for installation/adjustment procedures
Transfer Switch Motor	007701	Motor is supplied with gear box

Component Description	Thomson Technology Part Number	Comments
(100A-250A S Style Mechanism) 120V 20 watt 1 PH		assembly. Contact Thomson Technology Service Department for installation procedures
Transfer Switch Motor (400A-800A S Style Mechanism) 120V 30 watt 1 PH	007961	Motor is supplied with gear box assembly. Contact Thomson Technology Service Department for installation procedures
Transfer Switch Motor (1200A T-Style Mechanism) 120V 1/10 hp 1 PH	001075	Motor is supplied with gear box assembly. Contact Thomson Technology Service Department for installation procedures
120VAC Auxiliary Plug-in Relay, 11 pin Square (UX/GX)	001278	Must ensure coil voltage is correct
120VAC Auxiliary Plug-in Timer	001515	Must ensure coil voltage is correct
100VA Control Transformer	002159	

For other parts not listed, please contact Thomson Technology.

20. PRODUCT RETURN POLICY

Thomson Technology uses a Return Material Authorization (RMA) process. Please complete the [Return Authorization Request Form](#) (available on our web page) for return of goods, warranty replacement/repair of defective parts, or credit consideration and fax to the appropriate department.

Returns only: Sales Fax (604) 888-5606

Warranty replacement/Warranty Repair: Service Fax (604) 888-3370.

Upon receipt of your request, Thomson Technology will confirm with a copy of our Order Acknowledgement via fax advising the RMA number which should be used to tag the defective controller prior to shipment.

21. NOTES

22. PERFORMANCE TEST FORM

This form should be retained by those in charge of the building electrical installation in order to be available to the authority having jurisdiction.

Date	Personnel	Tests performed	Comments
		Interconnection evaluation	
		Grounding point evaluation	
		Fault current test:	
		Ground fault settings - _____	
		Simulated current - _____	
		Results - _____	

APPENDIX "A"

THOMSON TECHNOLOGY®

THOMSON TECHNOLOGY®
A Subsidiary of Repulse Corporation
POWER & CONTROL

TYPICAL AUTOMATIC TRANSFER SWITCH COMMISSIONING PROCEDURES Model Series TS 870

Note: The following commissioning procedures are provided for general information only pertaining to typical site installations and applications. Contact the equipment supplier for further information as may be required.

DANGER!!!!

Arc Flash and Shock Hazard. Will cause severe injury or death.

Do not open equipment until ALL power sources are disconnected

This equipment must be installed and serviced only by qualified electrical personnel utilizing safe work practices and appropriate Personal Protective Equipment (PPE). Failure to do so may cause personal injury or death

CAUTION

Commissioning procedures must be performed by qualified personnel only. Ensure the Automatic Transfer Switch (ATS) Control Isolation Plug is disconnected prior to energizing the supply sources. Manually place the transfer switch mechanism in the neutral position by opening both Utility and Generator Power Switching devices prior to applying power.

NOTE: An optional hand held, plug-in Service Display Module (SDM) is available for the TSC 80 Transfer Controller. The SDM module provides an LCD screen to display additional detailed information on the operation and settings of the TSC 80 controller for simplified servicing/trouble shooting procedures. For detailed information, refer to the separate SDM module instruction manual (PM065).

Pre-Commissioning Checks Prior to Commissioning Agent On-Site (to allow loads to be supplied prior to final commissioning)

- 1) Verify the system voltage of both sources (i.e. generator and utility) to be applied to the transfer switch are of the correct nominal system value which matches the ATS drawings and the ATS equipment label ratings. If the system voltage is correct, proceed to step 3. If system voltage is incorrect for the rating of the ATS supplied, proceed to step 2.

CAUTION: FAILURE TO RE-CONFIGURE ATS VOLTAGE TO MATCH SYSTEM VOLTAGE WILL RESULT IN EQUIPMENT MALFUNCTION AND DAMAGE.

NOTE: The factory default system voltage setting for multi-voltage TS 840/870 transfer switches is **480VAC**, which will be indicated by a letter "Y" in the voltage code as shown on the ATS model code (e.g. TS 873A0250A1A**Y**) and on a warning tag attached to the isolation plug.

- 2) To re-configure the ATS for the correct system voltage prior to energization, refer to **Appendix B** (as attached). For further information, refer to the TSC 80 controller manual supplied with the transfer switch.

APPENDIX "A"

THOMSON TECHNOLOGY®

THOMSON TECHNOLOGY®
A Subsidiary of Regal-Becht Corporation
POWER & CONTROL

TYPICAL AUTOMATIC TRANSFER SWITCH COMMISSIONING PROCEDURES Model Series TS 870

- 3) For 240V High Leg Delta systems refer to the ATS instruction manual for correct phasing required and re-configuring procedures.

CAUTION: FAILURE TO OBTAIN THE CORRECT ATS PHASING WILL RESULT IN EQUIPMENT MALFUNCTION AND DAMAGE.

- 4) Confirm cable size is correct for the lugs supplied in the transfer switch (line and load). Confirm the cables were meggered by the electrical contractor to ensure no cross phase connections or conduction to ground.
- 5) Confirm cable lugs are properly torqued. Confirm cable installation; ensure the cables do not interfere with normal equipment operation or which may cause component damage.
- 6) Manually operate the transfer mechanism to the appropriate source of supply. Leave the Isolation Plug disconnected until final Transfer Switch Commissioning is to be completed.

Final Commissioning

- 1) Verify installation of the Automatic Transfer Switch as per installation manual and verify wiring (also see the Pre-Commissioning Checks). Confirm phase, neutral and grounding conductors are installed as per electrical code requirements. **Note:** Confirm neutral conductors of both sources are correctly installed and are solidly grounded for 3 phase 4 wire configurations.
- 2) Check for mechanical damage (shipping or installer).
- 3) Check for cable interference with mechanical moving parts or the motor brake on 100A-250A ATS mechanism.
- 4) Verify correct control wire interconnects to the engine/generator set auto start/stop circuitry. Ensure the engine controller automatic start circuit does not draw more than 5.0 amps (resistive) across the TSC 80 Engine Start contact. The TSC80 Engine Start contact is voltage free and the only voltage measured should result from the engine controllers internal control logic. **Note:** The ATS Engine Start contact CLOSSES to start the engine and OPENS to stop the engine.
- 5) Place the generator engine controller in the "OFF" position and open the generator local circuit breaker.
- 6) Ensure the ATS isolation plug is disconnected prior to application of voltage of the supply sources.
- 7) Energize the utility supply and the generator supply sources and verify these meet the correct voltage, phasing and phase rotation for the ATS and system. Once these have been confirmed to be correct, de-energize both sources before installing the isolation plug.
- 8) Once the isolation plug is connected, the ATS and system load may be energized with utility power once the site electrical contractor and or owner (as required) give authorization to proceed.
- 9) If Utility power is within nominal limits, the ATS should transfer to the utility source. To determine correct operation, observe the following on the TSC 80 faceplate:
 - i) Utility Source green LED is "ON"
 - ii) Green LED above mimic bus for the Utility source is "ON"

APPENDIX “A”

THOMSON TECHNOLOGY®

THOMSON TECHNOLOGY®
A Subsidiary of Repulse Corporation
POWER & CONTROL

TYPICAL AUTOMATIC TRANSFER SWITCH COMMISSIONING PROCEDURES Model Series TS 870

- iii) Green “Load” LED is “ON”
- 10) To verify all LED’s are operational, perform a “LAMP TEST” operation (lamp test is initiated by pressing and holding the 2 push buttons on the TSC 80 faceplate simultaneously “ON” until all the LED’s change state).
- 11) Prior to operating the generator, ensure it is ready to be energized and the site electrical contractor and/or owner (as required) give authorization to proceed. In preparation for operation, turn the generator’s engine control switch to the “Automatic” start position.
- 12) To transfer the generator on load, perform a load test by pressing the Utility Power Fail Simulate pushbutton “ON” and holding it for approximately 5 seconds until the LED light above the push button changes state. The engine should start following the 3-second engine start delay period and the transfer switch will begin transferring to the generator supply once the 2-second engine warm-up timer expires. **Note:** The engine warm-up timer will only begin timing once the generator’s output rises above 85% nominal voltage and 90% nominal frequency. Once the Utility power switching device opens, the transfer switch mechanism will pause in the neutral position for the 3-second neutral delay period, then the mechanism will complete the transfer and close the generator power switching device. To determine correct operation, observe the following on the TSC 80 faceplate:
 - i) Generator Source green LED is “ON”
 - ii) Red LED above mimic bus for the generator source is “ON”
 - iii) Green “Load” LED is “ON”
 - iv) Utility Source green LED is “ON”
 - v) Utility Power Fail Simulate yellow LED is “ON”
 - vi) Green LED above mimic bus for the Utility source is “OFF”
- 13) To terminate the test, press the Utility Power Fail Simulate push button on the TSC 80 faceplate again and hold until the LED above the pushbutton changes state. The transfer switch will begin transferring to the utility supply following the 2-minute utility return delay period. **Note:** the utility return delay timer will only begin timing if the utility voltage is above 85% nominal on all phases. Once the Generator power switching device opens, the transfer switch mechanism will pause in the neutral position for the 3-second neutral delay period, then the mechanism will complete the transfer and close the Utility power switching device to return the load to the Utility source. Once the load has transferred onto the utility source, the engine will continue to run for the 2-minute cool down time delay period and will then it will automatically stop.
- 14) Perform a power outage test by opening the upstream utility feeder breaker. The TSC 80 controller Utility supply LED lights will de-energize; the generator set will start after the 3-second engine start delay has expired. The generator should transfer on load as described in item #12 above.
- 15) Return the transfer switch to utility power by re-closing the upstream utility breaker. The load should re-transfer back to the utility supply and the engine should stop as described in item #13 above.
- 16) Repeat tests #12 through 14 two (or more) times to ensure correct operation.
- 17) Automatic Plant Exercise Operation (**OPTIONAL**): If an automatic weekly plant exercise feature is desired, press the GENERATOR EXERCISE Mode push button on the TSC 80 faceplate.

APPENDIX “A”

THOMSON TECHNOLOGY®

THOMSON TECHNOLOGY
A Subsidiary of Regal-Bechtel Corporation
POWER & CONTROL

TYPICAL AUTOMATIC TRANSFER SWITCH COMMISSIONING PROCEDURES Model Series TS 870

Hold the push button “ON” for approximately 5 seconds until the LED light changes state. Once the mode is initiated, the engine will immediately start and the generator will transfer on load as previously described. **Note:** The generator may or may not transfer on load, which is dependent on the TSC 80 configuration setting. The factory default setting is for a “Load Transfer” plant exercise test. The engine will remain operating on load until the plant exercise time delay period expires, then the load will re-transfer back to the utility supply following the 2-minute utility return timer. The engine will be automatically re-tested on load every week (i.e. 7 days) at the same time of day that the first test was initiated. Refer to the TSC 80 manual for further information.

- 18) On completion of commissioning ensure all controls are left in automatic.
- 19) If required, forward document or drawing updates to the equipment supplier if revisions are required and provide the end user with a set of marked-ups to be retained on site.
- 20) Ensure copies of manuals for the equipment are on site.
- 21) Record and forward list of deficiencies to the appropriate parties where applicable.

APPENDIX “B”

THOMSON TECHNOLOGY®



INSTRUCTIONS TO CHANGE SYSTEM VOLTAGE ON TS 870 SERIES TRANSFER SWITCHES WITH TSC 80 CONTROLLER

DANGER!!!!

Arc Flash and Shock Hazard. Will cause severe injury or death.

Do not open equipment until ALL power sources are disconnected

This equipment must be installed and serviced only by qualified electrical personnel utilizing safe work practices and appropriate Personal Protective Equipment (PPE).

Failure to do so may cause personal injury or death

1. Ensure all power sources are de-energized prior to opening the transfer switch enclosure door.
2. Disconnect “Control Circuit Isolation Plug”
3. Change voltage transformer primary taps settings to match new system voltage on all potential transformers. (Refer to wiring schematic diagram Figure 1). Ensure all electrical connections are tight.
4. Remove rear cover on door mounted TSC 80 transfer controller.
5. Change voltage jumper setting to desired system voltage (Refer to Figure 2).
Note: 208V systems do not require a jumper on any pins.
6. Re-install rear cover for TSC 80 transfer controller.
7. Record new programmed voltage on calibration label on TSC 80 rear cover
8. Re-connect “Control Circuit Isolation Plug”.
9. Remove all tools and close transfer switch enclosure door.

APPENDIX "B"

THOMSON TECHNOLOGY®



INSTRUCTIONS TO CHANGE SYSTEM VOLTAGE ON TS 870 SERIES TRANSFER SWITCHES WITH TSC 80 CONTROLLER

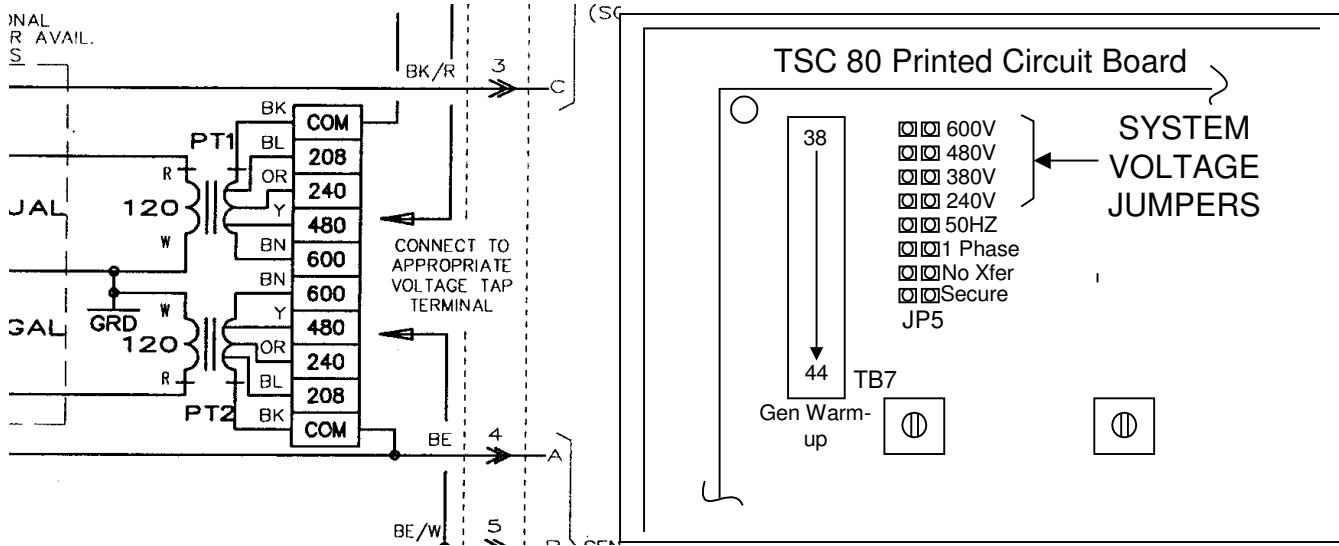

Figure 1

Figure 2

Free Manuals Download Website

<http://myh66.com>

<http://usermanuals.us>

<http://www.somanuals.com>

<http://www.4manuals.cc>

<http://www.manual-lib.com>

<http://www.404manual.com>

<http://www.luxmanual.com>

<http://aubethermostatmanual.com>

Golf course search by state

<http://golfingnear.com>

Email search by domain

<http://emailbydomain.com>

Auto manuals search

<http://auto.somanuals.com>

TV manuals search

<http://tv.somanuals.com>