

System Component

Operating Instructions

Model No. **SC-HD510**
SC-HD310

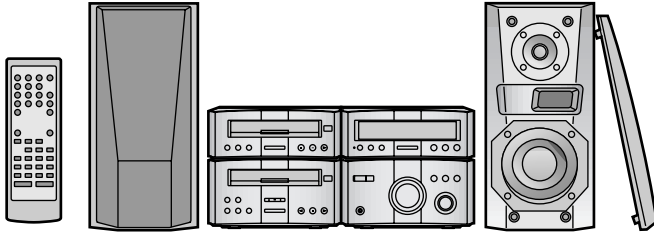

The illustrations show SC-HD510 for areas except Australia and N.Z.

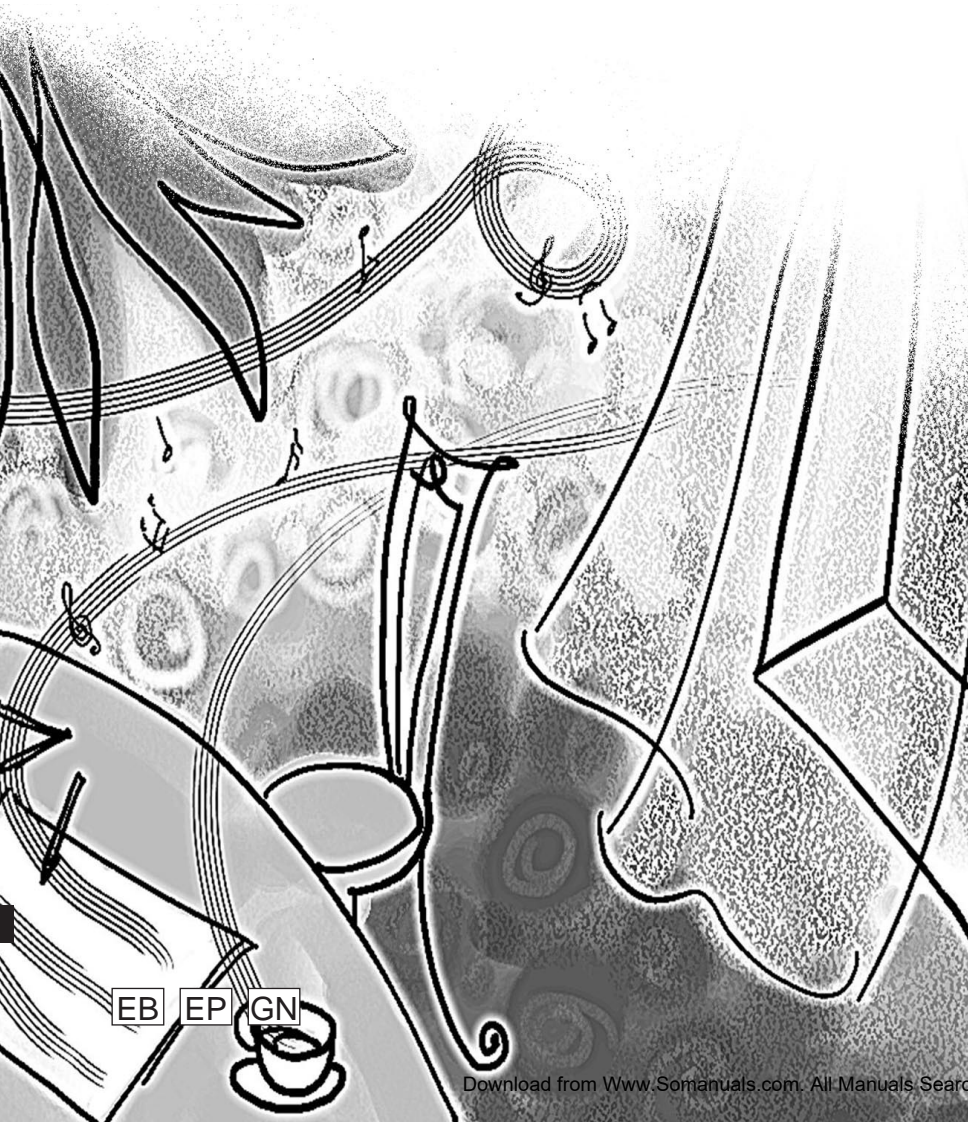

Note:

The "EB" indication shown on the outside packing case indicates United Kingdom.

Before connecting, operating or adjusting this product, please read these instructions completely. Please keep this manual for future reference.

EB EP GN

RQT5296-B

Dear Customer

Thank you for purchasing this product.
For optimum performance and safety, please read these instructions carefully.

These operating instructions are applicable to the following systems.

These operating instructions, however, fundamentally explain the operation of system SC-HD510.

System	SC-HD510	SC-HD310
Amplifier	SE-HD510	SE-HD310
Tuner	ST-HD510	ST-HD310
CD player	SL-HD510	SL-HD310
Cassette deck	RS-HDA710	RS-HD310
Speakers	SB-HD510	SB-HD310

CAUTION!

THIS PRODUCT UTILIZES A LASER.
USE OF CONTROLS OR ADJUSTMENTS OR PERFORMANCE OF PROCEDURES OTHER THAN THOSE SPECIFIED HEREIN MAY RESULT IN HAZARDOUS RADIATION EXPOSURE.
DO NOT OPEN COVERS AND DO NOT REPAIR YOURSELF. REFER SERVICING TO QUALIFIED PERSONNEL.

CAUTION!

DO NOT INSTALL OR PLACE THIS UNIT IN A BOOKCASE, BUILT IN CABINET OR IN ANOTHER CONFINED SPACE. ENSURE THE UNIT IS WELL VENTILATED. ENSURE THAT CURTAINS AND ANY OTHER MATERIALS DO NOT OBSTRUCT THE VENTILATION TO PREVENT RISK OF ELECTRIC SHOCK OR FIRE HAZARD DUE TO OVERHEATING.



(Back of product)

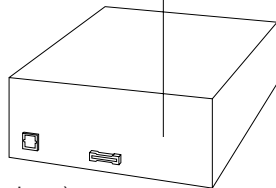

(CD player)

DANGER	INVISIBLE LASER RADIATION WHEN OPEN. AVOID DIRECT EXPOSURE TO BEAM.	(Inside of product)
ADVARSEL	USYNLIG LASERSTRÅLING VED ÅBNING, NÅR SIKKERHEDSAFBRYDERE ER UDE AF FUNKTION. UNDGÅ UDSÆTTELSE FOR STRÅLING.	(Indersiden af apparatet)
VARO!	AVATTAESSA JA SUOJALUKITUS OHTETTAESSA OLET ALTIINA NÄKYMÄTÖNTÄ LASERSÄTEILYLLE. ÄLÄ KATSO SÄTEESEEN.	(Tuotteen sisällä)
WARNING	OSYNLIG LASERSTRÅLING NÅR DENNA DEL ÅR ÖPPNAD OCH SPÅRREN ÅR URKOPPLAD. BETRakta EJ STRÅLEN.	(Apparatens insida)
ADVARSEL	USYNLIG LASERSTRÅLING NÅR DEKSEL ÅPNES OG SIKKERHEDSLAS BRYTES. UNNGÅ EKSPONERING FOR STRÅLEN.	(Produktets innside)
VORSICHT	UNSICHTBARE LASERSTRÅHLUNG, WENN ABDECKUNG GEÖFFNET. NICHT DEM STRAHL AUSSETZEN.	(Im Inneren des Gerätes)

Supplied accessories

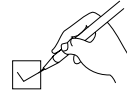

Please check and identify the supplied accessories.

- AC mains lead.....1 pc.
For United Kingdom (RJA0053-2X) For Australia and N.Z. (RJA0035-K)

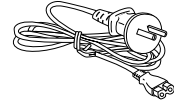
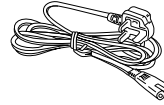

For others (RJA0019-X)

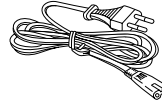

- Remote control.....1 pc.
For Australia and N.Z. (RAK-HDA26WH) For others (RAK-HDA25WH)

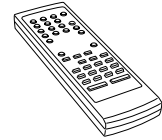
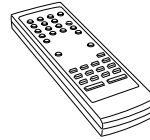

- Remote control batteries.....2 pcs.

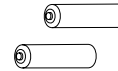

- FM indoor antenna1 pc.
For Australia and N.Z. (RSA0006) For others (RSA0007)

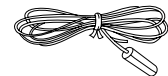
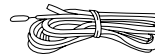

- AM loop antenna set (RSA0022-J).....1 pc.

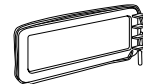

- Speaker cords
Red and black (REE0499)2 pcs.
Blue and gray (REE0853) **SC-HD510 only**2 pcs.

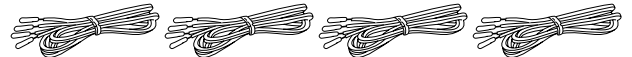

- Antenna plug adapter (SJP9009)1 pc.
(United Kingdom only)



Use numbers indicated in parentheses when asking for replacement parts.

Table of contents

Before use

Safety precautions	3
Caution for AC Mains Lead	4
The remote control	5
Installation	5
Connections	6
Front panel controls	9
Turning the DEMO function off	10
Setting the time	11
Saving power in standby mode	11

Radio operations

The Radio: manual tuning	12
The Radio: preset tuning	13

Cassette deck operations

Cassette tapes	14
-----------------------------	-----------

Compact disc operations

CDs	
Normal play.....	16
Other modes of play.....	17

Recording operations

Before recording	19
Preparatory steps.....	19
Recording the radio	20
Recording CDs	
Normal recording.....	20
One touch CD editing (AI EDIT).....	21

Timer operations

Using the timers	
The play timer.....	22
The record timer.....	23
The play and record timers.....	24
The sleep timer.....	24
Using the timers together.....	24

Reference

Using other equipment	25
Convenient functions	26
Maintenance	26
Troubleshooting guide	27
Technical specifications	Back cover

Safety precautions

Placement

Set the unit up on an even surface away from direct sunlight, high temperatures, high humidity, and excessive vibration. These conditions can damage the cabinet and other components, thereby shortening the unit's service life.

Place it at least 15 cm away from wall surfaces to avoid distortion and unwanted acoustical effects.

Do not place heavy items on the unit.

Voltage

Do not use high voltage power sources. This can overload the unit and cause a fire.

Do not use a DC power source. Check the source carefully when setting the unit up on a ship or other place where DC is used.

AC mains lead protection

Ensure the AC mains lead is connected correctly and not damaged. Poor connection and lead damage can cause fire or electric shock. Do not pull, bend, or place heavy items on the lead.

Grasp the plug firmly when unplugging the lead. Pulling the AC mains lead can cause electric shock.

Do not handle the plug with wet hands. This can cause electric shock.

Foreign matter

Do not let metal objects fall inside the unit. This can cause electric shock or malfunction.

Do not let liquids get into the unit. This can cause electric shock or malfunction. If this occurs, immediately disconnect the unit from the power supply and contact your dealer.

Do not spray insecticides onto or into the unit. They contain flammable gases which can ignite if sprayed into the unit.

Service

Do not attempt to repair this unit by yourself. If sound is interrupted, indicators fail to light, smoke appears, or any other problem that is not covered in these operating instructions occurs, disconnect the AC mains lead and contact your dealer or an authorized service center. Electric shock or damage to the unit can occur if the unit is repaired, disassembled or reconstructed by unqualified persons.

Extend operating life by disconnecting the unit from the power source if it is not to be used for a long time.

(For United Kingdom)

("EB" area code model only)

For your safety, please read the following text carefully.

This appliance is supplied with a moulded three pin mains plug for your safety and convenience.

A 5-ampere fuse is fitted in this plug.

Should the fuse need to be replaced please ensure that the replacement fuse has a rating of 5-ampere and that it is approved by ASTA or BSI to BS1362.

Check for the ASTA mark  or the BSI mark  on the body of the fuse.

If the plug contains a removable fuse cover you must ensure that it is refitted when the fuse is replaced.

If you lose the fuse cover the plug must not be used until a replacement cover is obtained.

A replacement fuse cover can be purchased from your local dealer.

CAUTION!

IF THE FITTED MOULDED PLUG IS UNSUITABLE FOR THE SOCKET OUTLET IN YOUR HOME THEN THE FUSE SHOULD BE REMOVED AND THE PLUG CUT OFF AND DISPOSED OF SAFELY. THERE IS A DANGER OF SEVERE ELECTRICAL SHOCK IF THE CUT OFF PLUG IS INSERTED INTO ANY 13-AMPERE SOCKET.

If a new plug is to be fitted please observe the wiring code as stated below.

If in any doubt please consult a qualified electrician.

IMPORTANT

The wires in this mains lead are coloured in accordance with the following code:

Blue: Neutral, Brown: Live.

As these colours may not correspond with the coloured markings identifying the terminals in your plug, proceed as follows:

The wire which is coloured Blue must be connected to the terminal which is marked with the letter N or coloured Black or Blue.

The wire which is coloured Brown must be connected to the terminal which is marked with the letter L or coloured Brown or Red.

WARNING: DO NOT CONNECT EITHER WIRE TO THE EARTH TERMINAL WHICH IS MARKED WITH THE LETTER E, BY THE EARTH SYMBOL \perp OR COLOURED GREEN OR GREEN/YELLOW.

THIS PLUG IS NOT WATERPROOF—KEEP DRY.

Before use

Remove the connector cover.

How to replace the fuse

The location of the fuse differ according to the type of AC mains plug (figures A and B). Confirm the AC mains plug fitted and follow the instructions below. Illustrations may differ from actual AC mains plug.

1. Open the fuse cover with a screwdriver.

Figure A

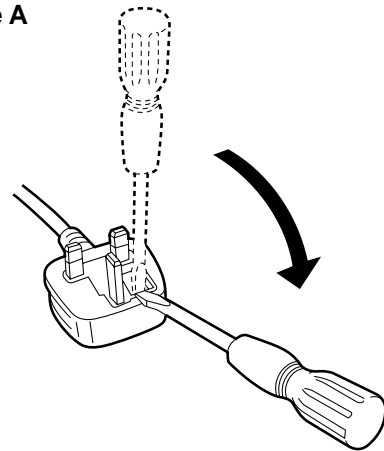
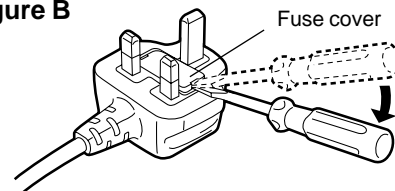

Figure B



2. Replace the fuse and close or attach the fuse cover.

Figure A

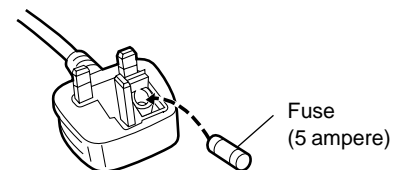
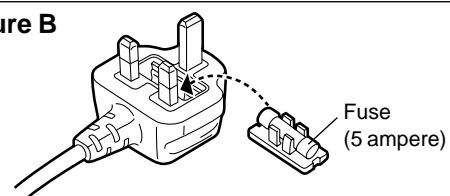
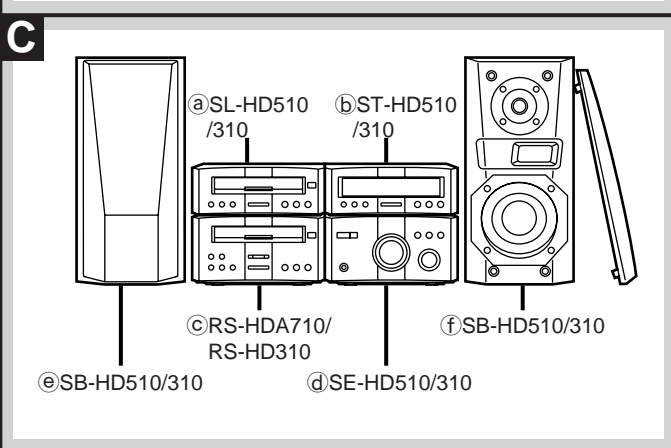
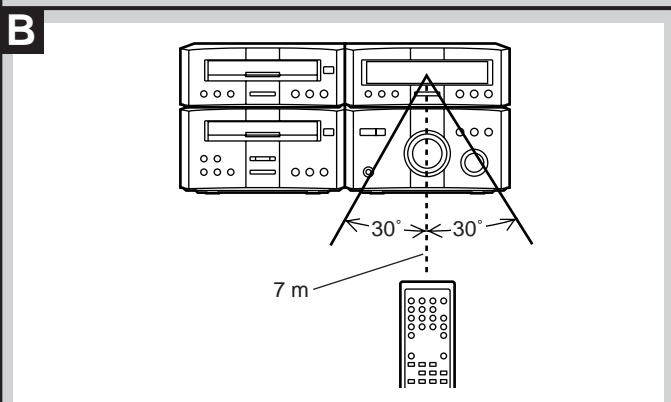
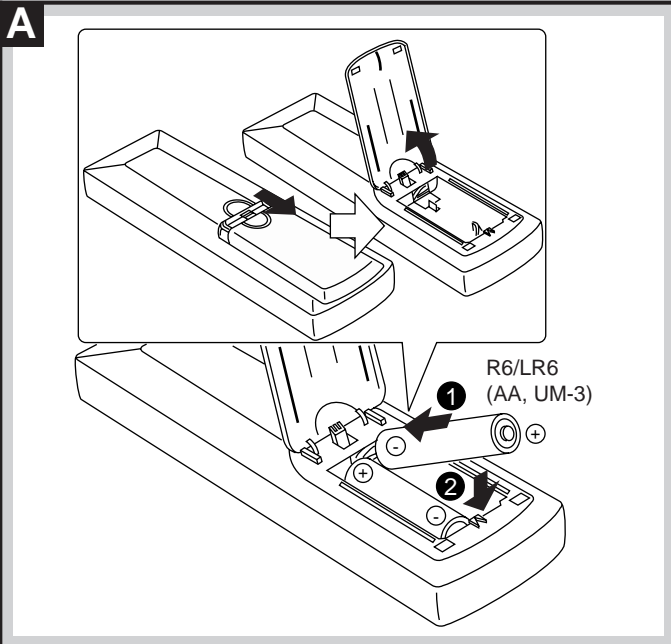

Figure B



The remote control



A Batteries

Insert so the poles (+ and -) match those in the remote control.
Do not use rechargeable type batteries.

Do not;

- mix old and new batteries.
- use different types at the same time.
- heat or expose to flame.
- take apart.
- short circuit.
- attempt to recharge alkaline or manganese batteries.

Mishandling of batteries can cause electrolyte leakage which can damage items the fluid contacts and may cause a fire.
If electrolyte leaks from the batteries, consult your dealer.
Wash thoroughly with water if electrolyte comes in contact with any part of your body.

Remove if the remote control is not going to be used for a long period of time. Store in a cool, dark place.
Replace if the unit does not respond to the remote control even when held close to the front panel.

If the battery lid comes loose, slide it back into place horizontally.

B Use

Aim at the sensor, avoiding obstacles, at a maximum range of 7 meters directly in front of the unit.

Keep the transmission window and the unit's sensor free from dust.

Operation can be affected by strong light sources, such as direct sunlight, and the glass doors on cabinets.

Do not;

- put heavy objects on the remote control.
- take the remote control apart.
- spill liquids onto the remote control.

C Installation

- a) CD player
- b) Tuner
- c) Cassette deck
- d) Amplifier
- e) Left speaker
- f) Right speaker

Note

These speakers do not have magnetic shielding. Do not place them near televisions, personal computers or other devices easily influenced by magnetism.

SC-HD310 only

Left and right speakers are exactly the same.



Caution

Use the speakers only with the recommended system. Failure to do so can damage the amplifier and speakers, and can cause fire. Consult a qualified service person if damage occurs or if a sudden change in performance is apparent.
Do not attach these speakers to walls or ceilings.

Connections

Unless otherwise marked, the illustrations show SC-HD510 sold outside Australia and New Zealand.

Before use

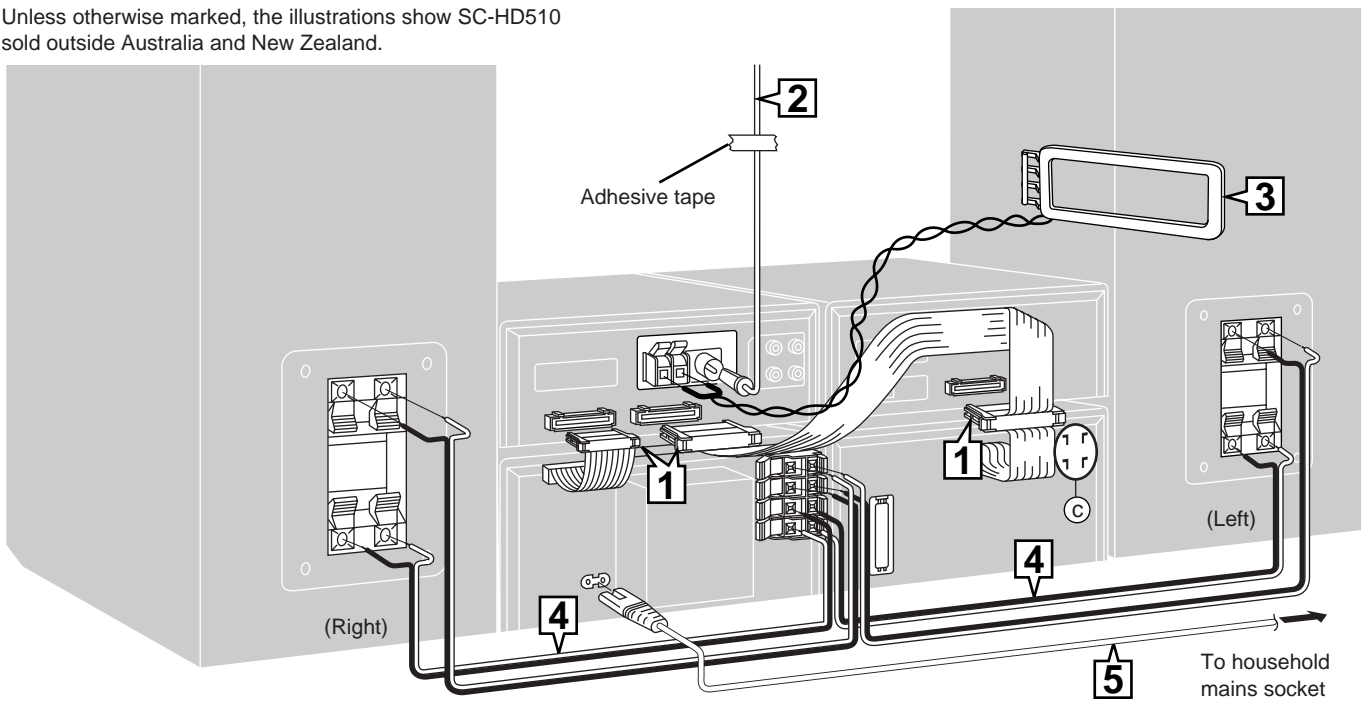

<p>A</p> <p>a </p> <p>b </p>	<p>3</p> <p>c </p>	
<p>1 To connect cables</p> <p>To unplug cables</p> <p>Hold the connector from both ends and pull it out.</p>	<p>4 Speaker</p> <p>SC-HD510</p>	<p>Amplifier</p> <p>SC-HD510</p>
<p>2 (For Australia and N.Z.)</p> <p>(For others)</p>	<p>SC-HD310</p>	<p>SC-HD310</p>

Basic connections for supplied accessories

A Before connection

Do not connect the AC mains lead until all other connections are complete.

To prepare the AM loop antenna, FM antenna (for Australia and N.Z.) and speaker cables, twist the vinyl tip and pull off (a).

Disconnect the flat cable on the cassette deck (b).

1 Flat cables.

Keep the cables as flat as possible against the back of the unit.

2 FM antenna.

Fix the other end of the antenna where reception is best.

3 AM loop antenna.

Keep loose antenna cord away from other wires and cords.

4 Speaker cables.

Connect the cables to the terminals of the same color. Never allow the exposed wires to contact each other when connected.

Use only the supplied speakers.

The combination of the system and the front speakers provides the best sound. Using other speakers can damage the unit and sound quality will be negatively affected.

(United Kingdom only)

BE SURE TO READ THE CAUTION FOR THE AC MAINS LEAD ON PAGE 4 BEFORE PROCEEDING TO STEP 5.

5 Connect the AC mains lead.

Insertion of connector

Even when the connector is perfectly inserted, depending on the type of inlet used, the front part of the connector may jut out as shown in the drawing.

However there is no problem using the unit.

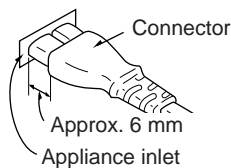

For your reference

Information you enter into the unit's memory, except for time, remains intact for up to two weeks after the mains lead is disconnected.

Note

The included AC mains lead is for use with this unit only. Do not use it with other equipment.

Connections

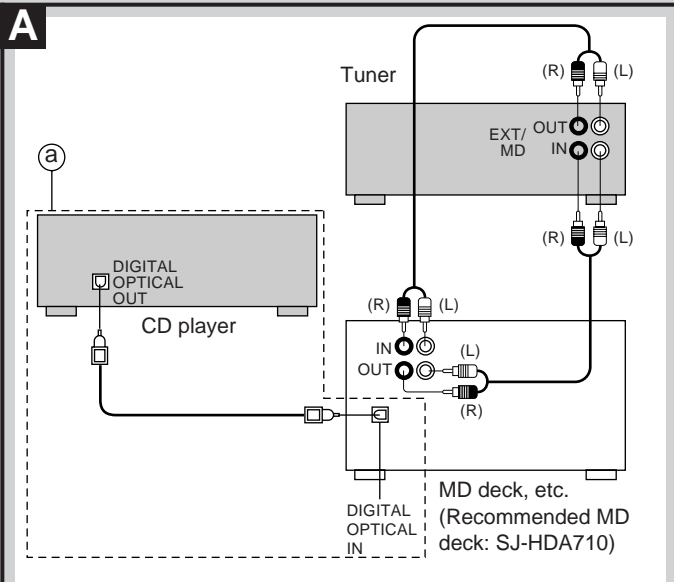

A External unit connections

Turn off the power to all units before making connections. Refer to the manual of the other unit for details. (Cables and equipment not included.)

To listen to other equipment and make recordings

Connect other equipment to the EXT/MD IN terminals to output sound through this unit's speakers or to record onto the cassette deck. Connect this unit to other equipment through the EXT/MD OUT terminals to record onto another recording device or output from this unit through the other unit.

Connect DVD players to the EXT/MD IN terminal on the tuner.

Stereo phono cable (not included)

White (L)
Red (R)

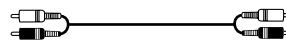

To make digital recordings (a):

Remove the dust cap before use.

Use an optical fiber cable to connect other digital recording equipment to DIGITAL OPTICAL OUT on the back of the CD player. This connection enables you to make digital recordings.

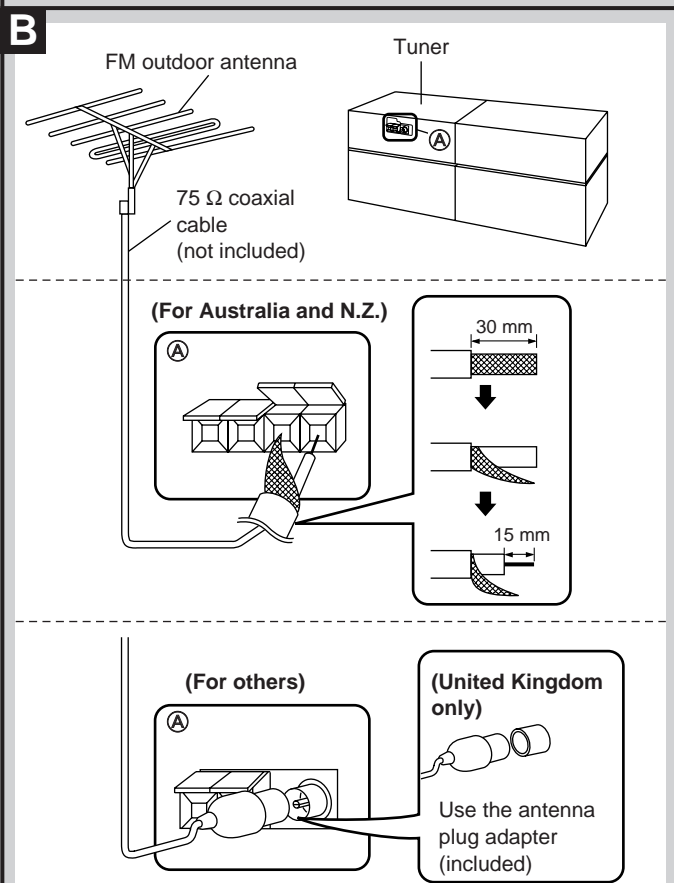

Optional antenna connections

Use outdoor antennas if radio reception is poor.

B FM outdoor antenna

Note

Disconnect the FM indoor antenna. The antenna should be installed by a competent technician.

C AM outdoor antenna

Run a piece of vinyl wire horizontally across a window or other convenient location.

Note

Leave the loop antenna connected. Disconnect the antenna when the unit is not in use. Do not use the antenna during an electrical storm.

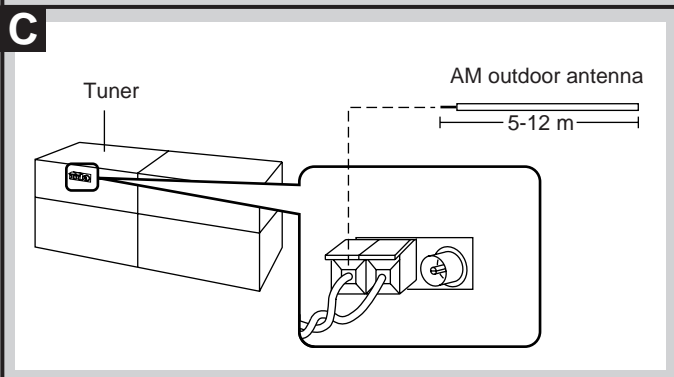

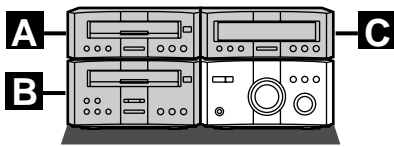

Front panel controls

A CD player

- ① Disc tray
- ② Disc tray open/close button (▲ OPEN/CLOSE).....16
- ③ CD TEXT button (CD TEXT)16
- ④ Scroll button (SCROLL)16
- ⑤ AI edit button (AI EDIT)21
- ⑥ Skip/search buttons (◀◀/◀, ▶/▶▶)16
- ⑦ Stop button (■).....16
- ⑧ Pause button (⏸).....16
- ⑨ Play button and indicator (▶).....16
The color of the indicator depends on the operation taking place.
If stopped: orange
If playing: green

A

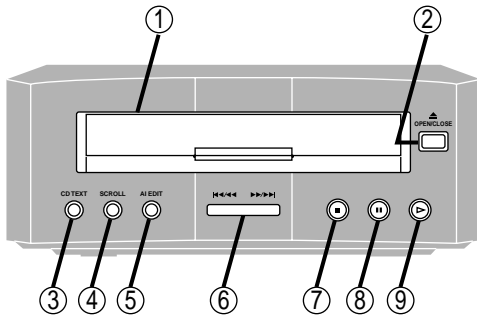

B Cassette deck

- ⑩ Cassette holder
- ⑪ Cassette tray open/close button (▲ OPEN/CLOSE)14
- ⑫ Counter button (COUNTER).....19
- ⑬ Dolby noise reduction button (DOLBY NR).....14
- ⑭ Counter reset button (RESET).....14
- ⑮ Reverse mode select button (REV MODE)14
- ⑯ Tape Program Sensor button (TPS SKIP)15
- ⑰ Fast forward/rewind buttons (◀◀ [TPS] ▶▶)15
- ⑱ Record pause button and indicator (● REC PAUSE)20
- ⑲ Playback buttons and indicators (◀, ▶).....14
The color of the indicator depends on the operation taking place.
If stopped, fast forwarding or rewinding: orange
If playing, recording, or carrying out TPS: green
- ⑳ Stop button (■)14

B

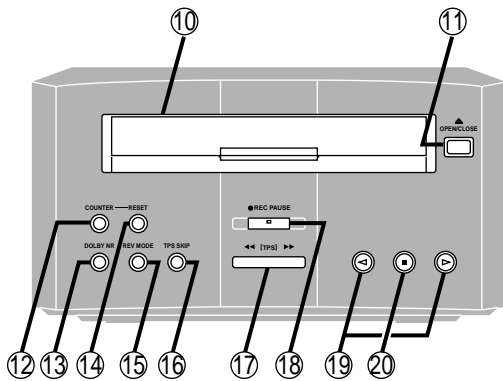

C Tuner

- ㉑ Display panel
The display also shows information for the cassette deck, CD player, and amplifier.
- ㉒ Play timer/record timer button and indicator
(⌚ PLAY/⌚ REC)22, 23, 24
- ㉓ Clock/timer, demo button
(CLOCK/TIMER, -DEMO).....10, 11, 22
- ㉔ Set button (SET).....11
- ㉕ Tuning/time adjust buttons
(TUNE/TIME ADJUST,)11,12
- ㉖ Tuning mode button (TUNE MODE)12
- SC-HD510 for areas except Australia and N.Z.**
- ㉗ RDS button (RDS)12
- ㉘ Band select button (FM/AM)12
- SC-HD310 SC-HD510 for Australia and N.Z.**
- ㉗ FM band select button (FM)12
- ㉘ AM band select button (AM)12

C

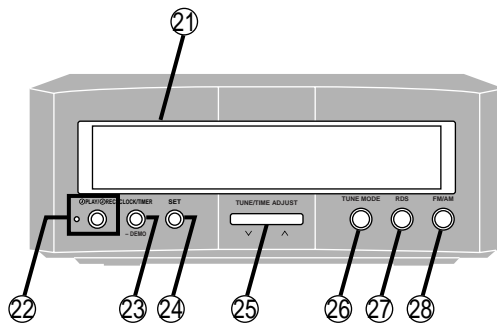

Before use

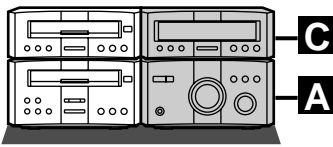

Front panel controls

A Amplifier

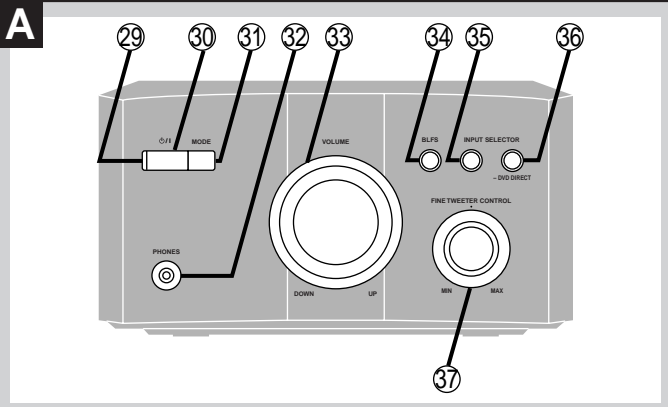

- 29 **Standby indicator**
When the unit is connected to the AC mains supply, this indicator lights up in standby mode and goes out when the unit is turned on.
- 30 **Standby/on switch (⏻/⏻)**11
Press to switch the unit from on to standby mode or vice versa. In standby mode, the unit is still consuming a small amount of power.
- 31 **ECO mode button (MODE)**11
- 32 **Headphone jack (PHONES)**.....25
- 33 **Volume control (VOLUME)**.....12

SC-HD510 only

- 34 **Bass button (BLFS)**26
- 35 **Input selector (INPUT SELECTOR ▼)**25
- 36 **Input selector (INPUT SELECTOR ▲, -DVD DIRECT)**25
- 37 **Fine tweeter control (FINE TWEETER CONTROL)**.....26

SC-HD310 only

- 34 **Bass button (BASS)**.....26
- 35 **Treble button (TREBLE)**.....26
- 36 **Input selector (INPUT SELECTOR)**25

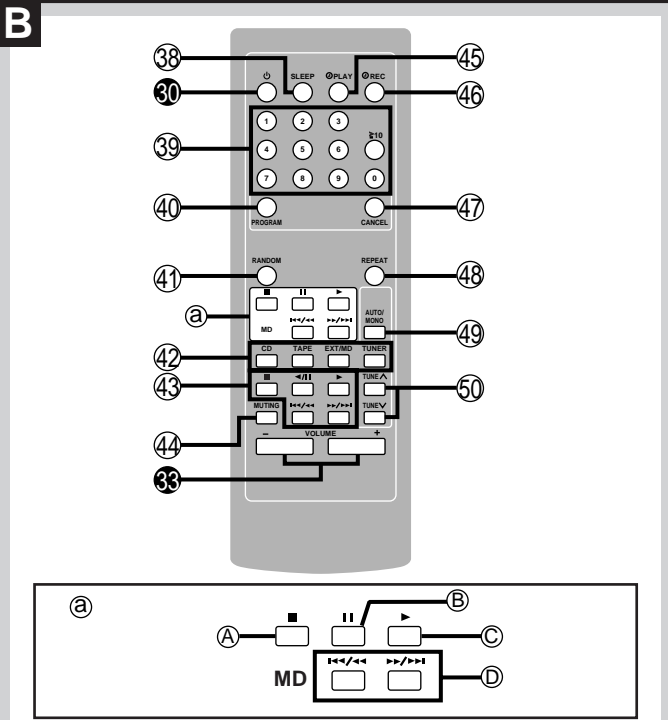

B Remote control

Buttons 30 and 33 function in the same way as the controls on the main unit.

- 38 **Sleep timer button (SLEEP)**24
- 39 **Numbered buttons**.....13
- 40 **Program button (PROGRAM)**.....18
- 41 **Random button (RANDOM)**.....17
- 42 **Input select buttons (CD, TAPE, EXT/MD, TUNER)**.....12, 15, 17, 25
- 43 **Basic operating buttons**
Function changes according to the source.
- 44 **Muting button (MUTING)**26
- 45 **Play timer button (⌚ PLAY)**22
- 46 **Record timer button (⌚ REC)**23
- 47 **Cancel button (CANCEL)**18
- 48 **Repeat button (REPEAT)**.....17
- 49 **FM mode button (AUTO/MONO)**.....12
- 50 **Tuning buttons (TUNE , TUNE)**12

For areas except Australia and N.Z.

MD deck operations (when connected to MD deck SJ-HDA710 (sold separately)) ②

- ① **Stop button (⏻)**
- ② **Pause button (⏸)**
- ③ **Play button (▶)**
- ④ **Skip/search buttons (⏮/⏪, ⏩/⏭)**

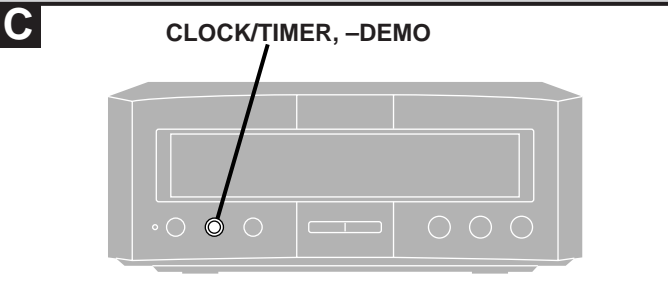

C Turning the DEMO function off

If the clock has not been set, a demonstration of the display is shown when the unit is off.

This function is set to on at the time of purchase.

To get the most from ECO mode (➡ page 11), turn this function off.

Press and hold [CLOCK/TIMER, -DEMO] until "NO DEMO" is displayed.

Each time you press and hold the button:
DEMO MODE (on) ↔ NO DEMO (off)

CLOCK/TIMER



DEMO MODE



NO DEMO

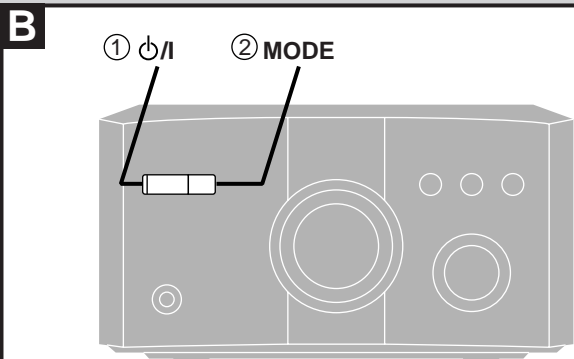
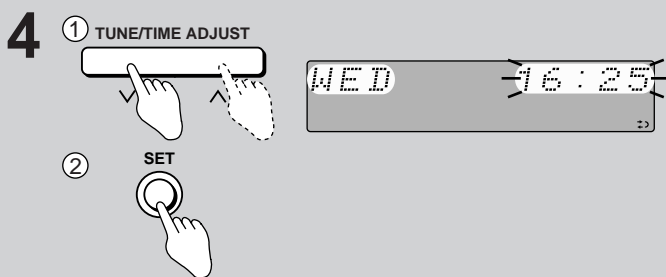
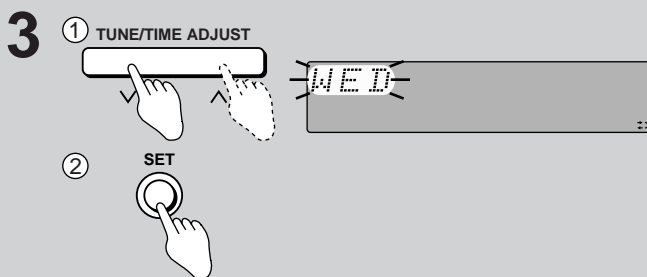
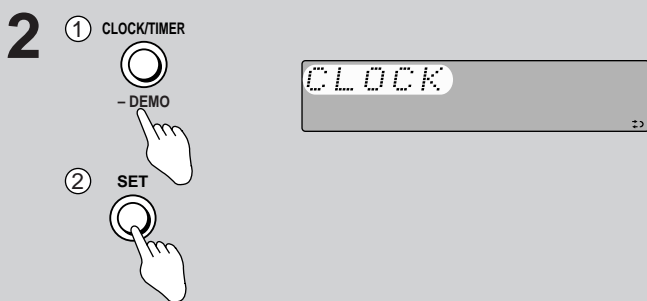
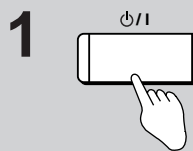
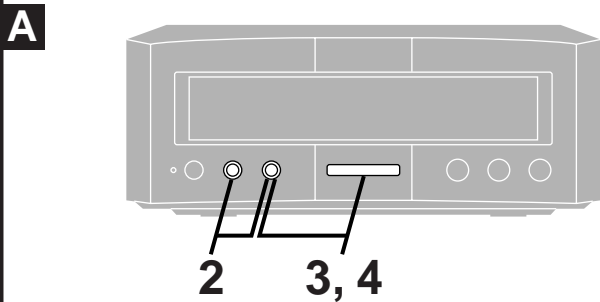
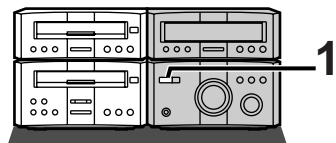

A Setting the time

This is a 24-hour clock.

The example shows how to set the clock for Wednesday 16:25 (4:25 pm).

- 1 Press [] to turn the unit on.
- 2 ① Press [CLOCK/TIMER, -DEMO] to display "CLOCK."
Each time you press the button:
CLOCK → PLAY → REC → Original display
② Within 7 seconds
Press [SET].
- 3 ① Press [TUNE/TIME ADJUST (or)] to set the day.
② Press [SET].
- 4 ① Press [TUNE/TIME ADJUST (or)] to set the time.
② Press [SET].
The time is set and the original display is restored.

Displaying the clock

Press [CLOCK/TIMER, -DEMO].

The clock is shown for about 5 seconds.

B Saving power in standby mode

When this mode is turned on, the clock is not displayed when the unit is in standby mode, thereby reducing standby mode power consumption from 9 W to 0.8 W. The standby indicator still lights.

Note

Turn DEMO off. ECO does not work when DEMO is on.

Turning ECO on and off:

- ① Press [] to turn the unit on.
- ② Press [MODE].
The current mode is displayed. Press again to change the mode.
Each time you press the button:
NORMAL (off) ↔ ECO (on)

The mode can be switched to ECO when the unit is off but it can not be switched back to NORMAL.

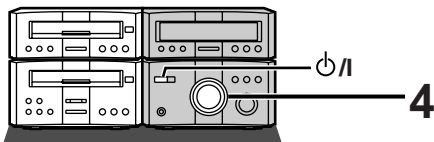

SC-HD310 SC-HD510 for Australia and N.Z.

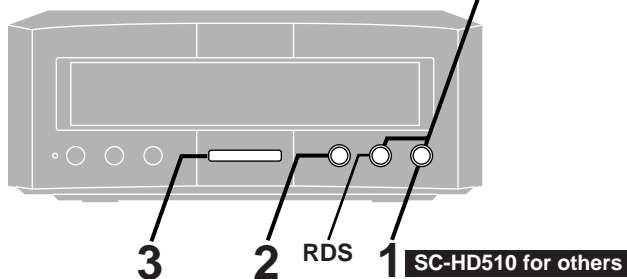

1 SC-HD310 SC-HD510 for Australia and N.Z.

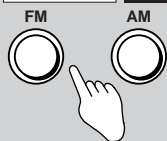

FM 87.50MHz

SC-HD510 for others



2 TUNE MODE



MANUAL

3 TUNE/TIME ADJUST

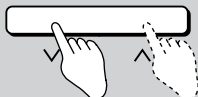

FM 88.10MHz
TUNED STEREO

4 VOLUME

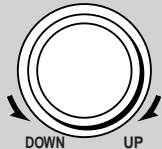

A

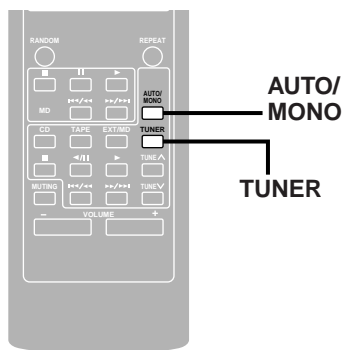

The Radio: manual tuning

Radio stations can be tuned manually by selecting the station's frequency or they can be preset into channels to make it easy to tune with the remote control (➔ page 13).

Preparation: Turn the unit on.

1

SC-HD310 SC-HD510 for Australia and N.Z.

Press [FM] or [AM] to select the band.

SC-HD510 for others

Press [FM/AM] to select the band.

Each time you press the button:

FM ↔ AM

2

Press [TUNE MODE] to select "MANUAL".

Each time you press the button:

MANUAL ↔ PRESET

3

Press [TUNE/TIME ADJUST (or)] to select the frequency of the required station.

"TUNED" is displayed when a radio station is tuned.

"STEREO" is displayed when a stereo FM broadcast is being received.

4

Adjust the volume.

On the remote control

1. Press [TUNER] to select the band.

2. Press [TUNE] or [TUNE] to select the frequency.

Auto tuning

Press and hold [TUNE/TIME ADJUST (or)] for a moment until the frequency starts changing rapidly. The unit begins auto tuning, stopping when it finds a station.

RDS broadcasting

SC-HD510 for areas except Australia and N.Z.

This unit can display the text data transmitted by the radio data system (RDS) available in some areas.

Changing the display

Press [RDS].

Each time you press the button:

PS display (the name of the station)

PTY display (the type of program)

RT display (various kinds of information, such as call-in numbers, weather, and news.)

Frequency display

Note

RDS displays may not be available if reception is poor.

A

One touch play

Remote control only

When the unit is off, press [TUNER].

The unit comes on and starts playing the radio with the volume fading in.

A

If noise is excessive in FM

Remote control only

Press [AUTO/MONO] to display "MONO".

Each time you press the button:

AUTO ↔ MONO

This mode improves sound quality if reception is weak for some reason but broadcasts are heard in monaural.

Press [AUTO/MONO] again to cancel the mode.

MONO is also canceled if the frequency is changed.

Leave the tuner in AUTO for normal listening. Stereo and monaural broadcasts are automatically played as they are received.

The Radio: preset tuning

Choose either automatic presetting, which presets all the stations the tuner can receive, or manual presetting, which allows you to select the stations to preset and the order they are to be preset in. There are 39 channels available for presetting.

A Automatic presetting

Do the following once each for FM and AM.

Preparation: Tune to the frequency presetting is to begin at. (➔ page 12).

Hold down [SET].

Release the button when "AUTO MEMORY" appears.

The tuner presets all the stations it can receive into the channels in ascending order. FM stations are preset into channels 1 to 39, and AM stations are preset into channels 21 to 39.

"SET OK" is shown when presetting is complete and the last station to be preset is played.

"ERROR" is displayed if the tuner doesn't receive any stations. Do presetting manually if this happens (see below).

Note

AM stations replace any FM channels that were preset in channels 21 to 39.

Manual presetting

Preset the stations one at a time.

- ① Tune to the required station.
- ② Press [SET].
- ③ Press [TUNE/TIME ADJUST (or)] to select a channel.
- ④ Press [SET].

The station occupying a channel is erased if another station is preset in that channel.

B Selecting channels

On the remote control

1 Press [TUNER].

The unit automatically comes on.

2 Press the numbered buttons to select the channel.

For channels 1 to 9 press the corresponding number.

For channels 10 or over press [≥10], then the two digits.

e.g. To select channel 21 [≥10] [2] [1]

On the main unit

1. Press [TUNE MODE] to select "PRESET".
2. Press [TUNE/TIME ADJUST (or)] to select the channel.

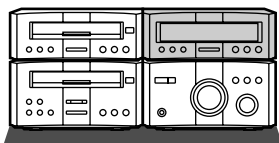

A

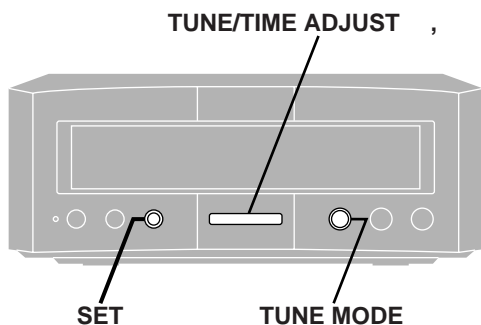

SET

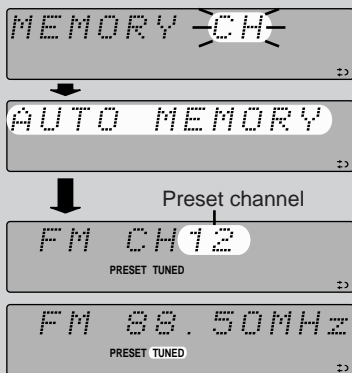

B

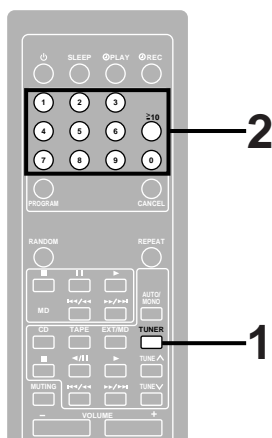

1

TUNER



2

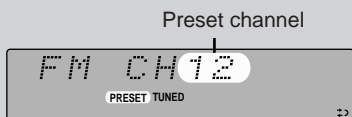
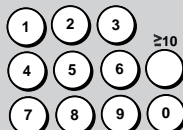

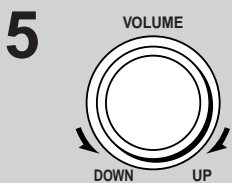
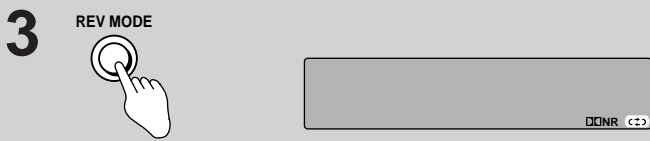
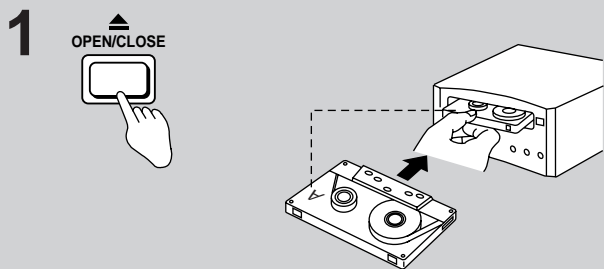
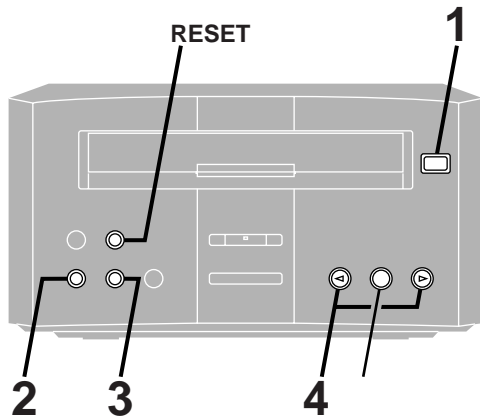
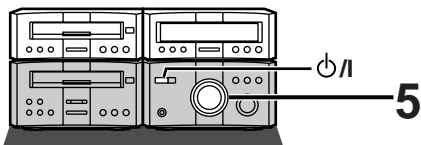

Cassette tapes

Preparation: Turn the unit on.

- 1 Press [▲ OPEN/CLOSE], insert the cassette with the tape facing in.**
Make sure the cassette is fully inserted and press [▲ OPEN/CLOSE] to close the deck.
- 2 Press [DOLBY NR] to select Dolby NR on ("DD NR" appears) or off.**
- 3 Press [REV MODE] to select the reverse mode.**
Every time the button is pressed:
 ↔ : One side is played.
 ↻ : Both sides are played.
 ↻↻ : Both sides are played eight times each.
- 4 Press [◀] or [▶].**
Play begins and the indicator changes to green.
 ▶ : to play the forward side (facing up).
 ◀ : to play the reverse side (facing down).
- 5 Adjust the volume.**

To stop the tape

Press [].

A Resetting the tape counter

Press [RESET].

Cassette tape selection and care

The unit can correctly play the following types. It identifies the type automatically.

Normal position/TYPE I	✓
High position/TYPE II	✓
Metal position/TYPE IV	✓

Tapes exceeding 100 minutes are thin and can break or get caught in the mechanism.

Tape slack can get caught up in the mechanism and should be taken up before the tape is played.

Endless tapes can get caught up in the deck's moving parts if used incorrectly. Use tapes appropriate to this unit's auto-reverse mechanism.

Dolby noise reduction

Dolby NR reduces "hissing" when playing tapes. It increases the high frequency region when recording and then reduces it in playback. Use the same system during playback and recording.

This unit has Dolby B NR which reduces noise to a third. Pre-recorded cassettes and equipment marked "DD" use Dolby B NR.

Dolby noise reduction manufactured under license from Dolby Laboratories Licensing Corporation. "DOLBY" and the double-D symbol DD are trademarks of Dolby Laboratories Licensing Corporation.

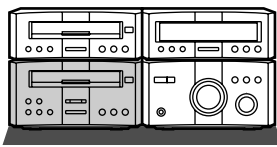

Cassette tapes

A Fast-forwarding and rewinding

Press [◀◀ TPS] or [TPS ▶▶] while the tape is stopped.

Tape direction	rewind	fast-forward
▶	◀◀	▶▶
◀	▶▶	◀◀

High-speed fast-forward/rewind

This cassette deck is designed to roughly double fast-forward/rewind speed automatically.

When you fast-forward from the beginning of the tape or rewind from the end of it, the tape runs at high speed.

When approaching the end of the tape, the deck automatically drops to normal speed.

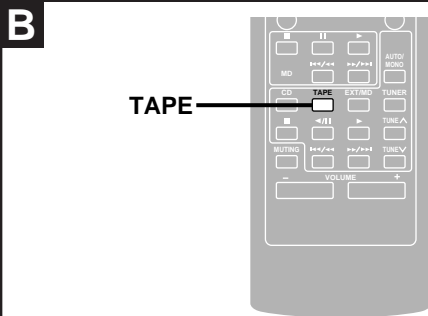
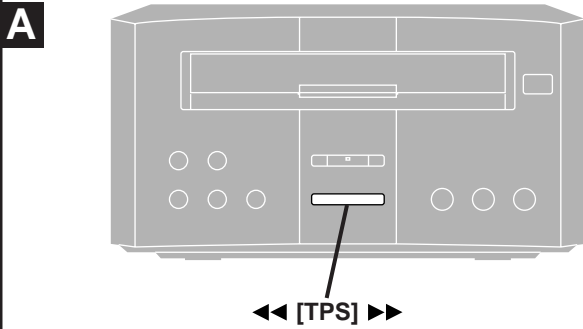

B One touch play

Remote control only

When a cassette is loaded and the unit is off, press [TAPE].

The unit comes on and starts play in the direction last selected with the volume fade in.

C Tape program sensor (TPS)

TPS finds the beginning of a track and starts play from there. You can skip up to nine tracks.

- 1 Press [TPS SKIP] to select the number of tracks you want to skip.
- 2 Press [◀◀ TPS] or [TPS ▶▶] to select the direction.

Tape direction	backward	forward
▶	◀◀	▶▶
◀	▶▶	◀◀

Pressing [◀◀ TPS] or [TPS ▶▶] during play takes you to the beginning of the current track or the next track, depending on tape direction.

To cancel

Press [].

Note

Stop the tape before changing the TPS direction.

TPS may not operate correctly in the following situations:

If the interval between tracks is less than 4 seconds.

If there is noise between tracks.

If there are silent parts within tracks.

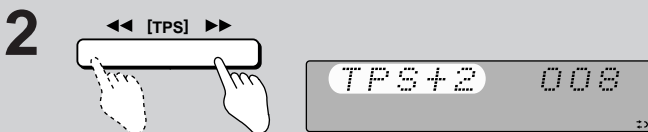
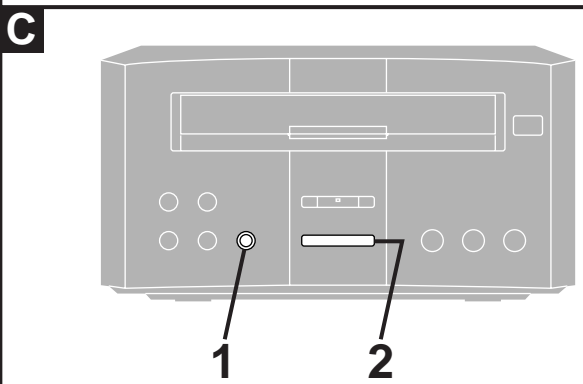

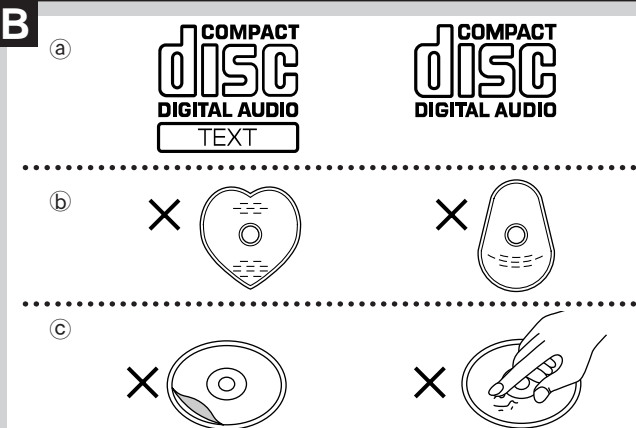
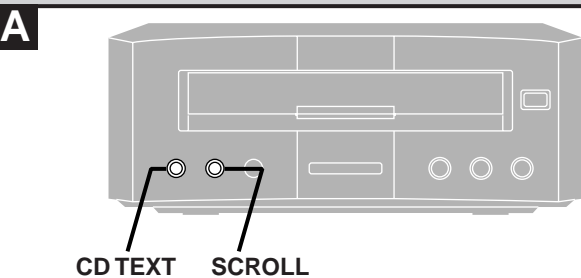
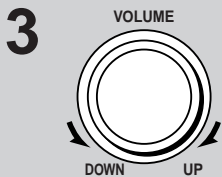
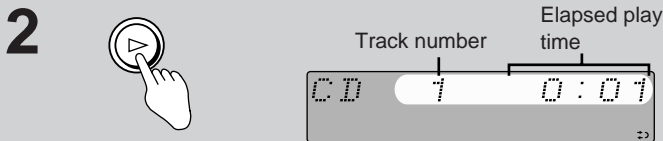
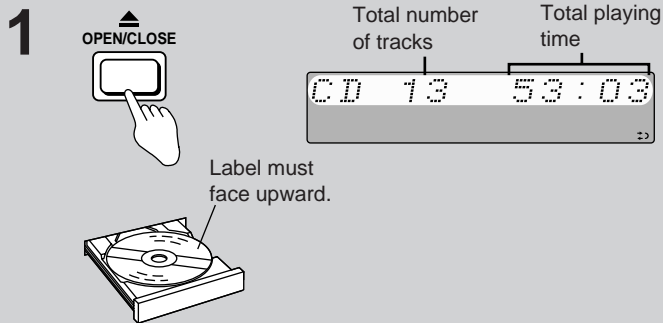
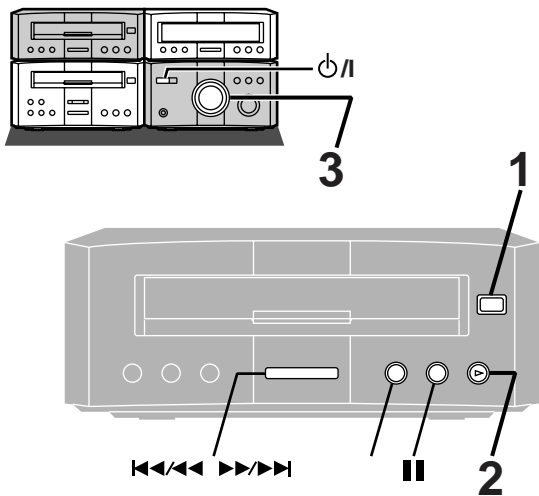

CDs

Normal play

Preparation: Turn the unit on.

1 Press [▲ OPEN/CLOSE] to open the tray.

Set a CD label up on the tray.

Press [▲ OPEN/CLOSE] to close the tray.

The number of tracks and playing time is displayed if "CD" is selected as the source.

2 Press [▶] to start play.

3 Adjust the volume.

To stop the disc

Press [].

To pause play

Press [⏸] during play. Press [⏸] or [▶] to resume play.

Skipping tracks

Press [◀◀/▶▶] (backward), or [▶▶/▶▶] (forward).

Searching through tracks

During play

Press and hold [◀◀/▶▶] (backward), or [▶▶/▶▶] (forward).

"NO DISC" is displayed

When the unit is in CD mode but a disc isn't in the player.

Note

You cannot skip to tracks already played in random play. (→ page 17).

Skipping is done in the selected order in program play. (→ page 18).

(→ page 18).

You can search only within tracks in random and program play.

A CD text discs

This unit reads and displays the information on these discs.

To switch between the text display and the normal display: Press [CD TEXT].

Scrolling the text

Press [SCROLL].

"SCROLL ON" is shown and the information scrolls across the display.

Press [SCROLL] again to cancel.

Scroll does not work if the text is less than 12 letters.

B CD selection and care

Choose discs with these marks: (a)

Do not;

use irregularly shaped CDs (b).

attach extra labels and stickers.

use CDs with labels and stickers that are coming off or with adhesive exuding from under labels and stickers (c).

attach scratch-proof covers or any other kind of accessory.

write anything on the CD.

clean CDs with liquids (Wipe with a soft, dry cloth.).

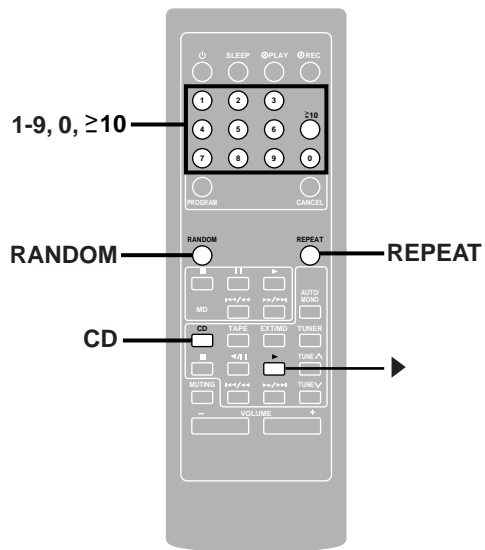

A One touch play

Remote control only

When a CD is loaded and the unit is off, press [CD].
The unit comes on and starts play with the volume fading in.

Other modes of play

Remote control only

Preparation:

Press [CD] to put the unit in CD mode.

B Direct access play:

Starts normal play from a selected track

Select the track with the numbered buttons.

For tracks numbered 10 and over, press [≥10] then the two digits.

C Random play:

Plays the tracks once each in random order

Press [RANDOM].

To cancel

Press [RANDOM].
"RANDOM" goes out.

D Repeat play:

Repeats all tracks or programmed tracks

Press [REPEAT] before or during play.

To cancel

Press [REPEAT].
"↻" goes out.

Repeating selected tracks

1. Program the track(s) (➡ step 1 and 2, page 18).
2. Press [REPEAT] to display "↻".
3. Press [▶].

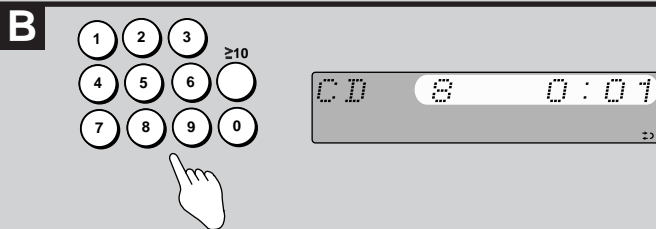
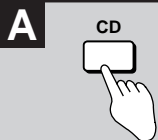

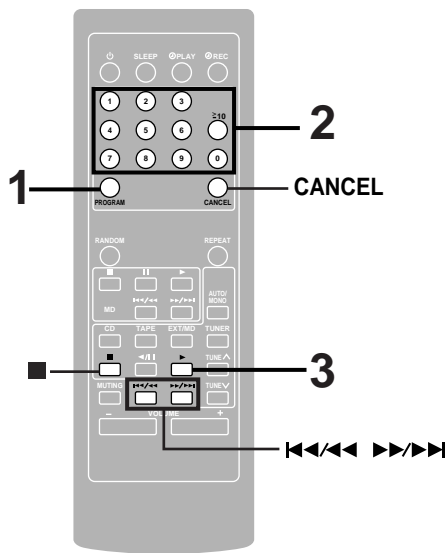

1



PROGRAM



2

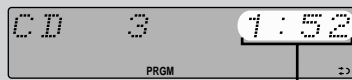
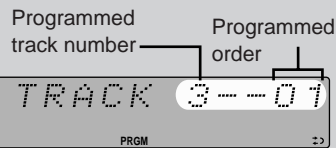
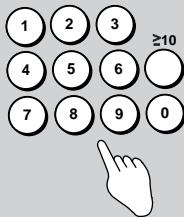

Total playing time

3

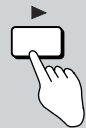

CDs

Other modes of play

Program play:

Select up to 24 tracks to play in the order you choose

Remote control only**Preparation:**

Press [CD] to put the unit in CD mode.

1 Press [PROGRAM].**2 Enter the track number with the numbered buttons.**For tracks numbered 10 and over, press [≥ 10] then the two digits.

Repeat this step to program the tracks in the required order.

3 Press [▶].

All the tracks are played in the selected order.

To cancel

Press [PROGRAM].

"CLEAR" is displayed and all the tracks are canceled. If a track was playing, play continues to the end of the CD.

"FULL" is displayed

If 24 tracks have been programmed. No more tracks can be programmed.

"- -: -" is displayed

If total playing time for the tracks is over 199 minutes and 59 seconds or track numbered 25 or over was programmed. Tracks can still be programmed and played.

To check the contents of the program

Press [◀◀/▶▶] or [▶▶/▶▶] while stopped. The track numbers and program position are displayed in order each time you press the button.

To add to the end of the program

Repeat step 2.

Canceling tracks (only while stopped)

From the last track	Press [CANCEL]. "CANCEL" is displayed.
A particular track	Select the track with [◀◀/▶▶] or [▶▶/▶▶] then press [CANCEL].
All tracks	Press []. Program play is also cleared.

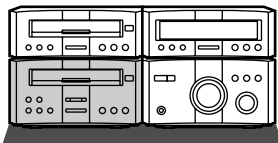

A

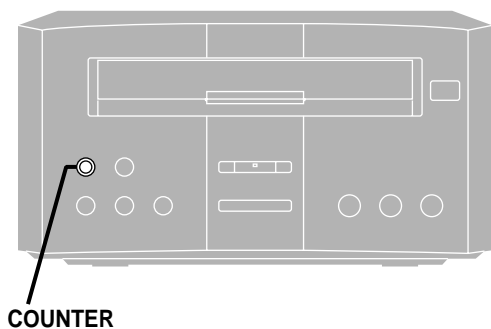

COUNTER

B

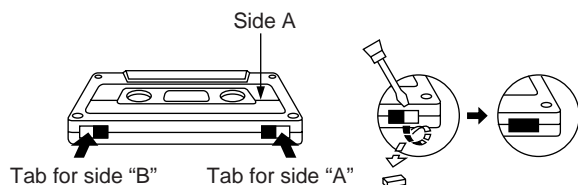

Tab for side "B" Tab for side "A"

To re-record

Normal tape

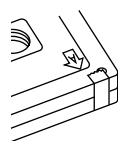

Hi-position tape

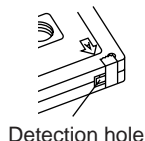

Detection hole

C

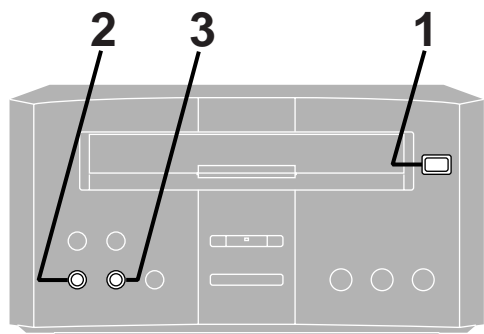

1



OPEN/CLOSE

2



DOLBY NR



3



REV MODE

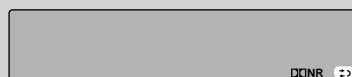

Before recording

Selection of tapes for recording

The unit automatically identifies the type of tape.

Normal position/TYPE I	✓
High position/ TYPE II	✓
Metal position/ TYPE IV	✓

A To display the tape counter while recording

Press [COUNTER].

The counter is displayed for about five seconds.

B Erasure prevention

The illustration shows how to remove the tabs to prevent recording. To record on the tape again, cover as shown, being careful not to cover the high position discrimination hole.

Volume and sound quality

Recordings are unaffected by changes to volume and sound quality.

C Preparatory steps

Do these steps before each recording.

Wind up the leader tape so recording can begin immediately (unnecessary if CD editing).

1 Press [**▲ OPEN/CLOSE**], insert the cassette with the tape facing in.

Make sure the cassette is fully inserted and press [**▲ OPEN/CLOSE**] to close the deck.

2 Press [**DOLBY NR**] to select Dolby NR on ("DC NR" appears) or off.

(→ "Dolby noise reduction" page 14).

3 Press [**REV MODE**] to select the reverse mode.

Each time you press the button:

- ↔ : One side only records.
- ↔ and ↔ : Both sides record (forward reverse).
- "↔" automatically changes to "↔" when [REC PAUSE] is pressed.

Erasing recordings

1. Press [INPUT SELECTOR] to select "TAPE".
2. Press [DOLBY NR] so that "DC NR" goes off.
3. Select the reverse mode.
4. Press [REC PAUSE].
5. Press [◀] or [▶].

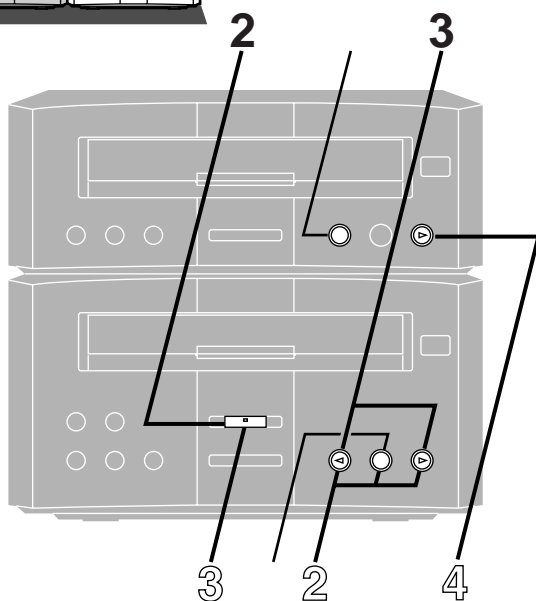
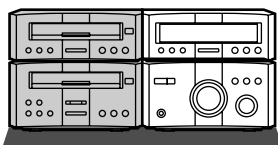
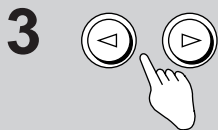
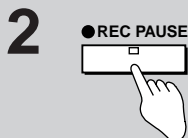
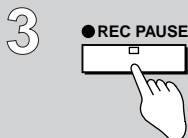
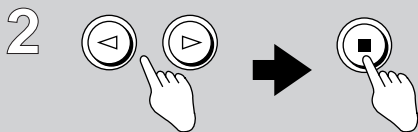
**A****B****A** Recording the radio

Preparation: Do the preparatory steps (➔ page 19).

- 1 Tune to the required station.**
(➔ page 12 or 13)
- 2 Press [REC PAUSE].**
The deck goes into the recording standby mode, [REC PAUSE] indicator lights and a play indicator starts flashing.
- 3 Press [◀] or [▶] to start recording.**
▶: to record on the forward side
◀: to record on the reverse side

To stop recording

Press [].

To temporarily stop recording

Press [REC PAUSE].

The deck goes into recording standby mode.

Press the [◀] or [▶] button with the flashing indicator to resume recording.

Recording CDs

B Normal recording

Preparation: Do the preparatory steps (➔ page 19).

- 1 Insert a CD.**
(➔ page 16)
- 2 Press [◀] or [▶] then [] to set the tape direction.**
▶: to record on the forward side
◀: to record on the reverse side
- 3 Press [REC PAUSE].**
The deck goes into the recording standby mode, [REC PAUSE] indicator lights and the play indicator starts flashing.
- 4 Press [▶] on the CD player.**
Recording starts automatically.

Four seconds after the CD finishes, the deck goes into the recording standby mode.

To stop recording**EITHER**

Press [] on the CD player.

The deck goes into the recording standby mode four seconds later.

OR

Press [] on the deck.

Recording stops immediately but the CD continues to play.

To record programmed tracks.

Program tracks after step 1 (➔ step 1 and 2, page 18).

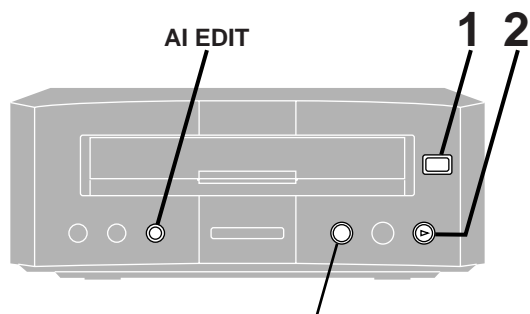
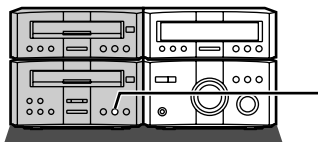

Recording CDs

A One touch CD editing (AI EDIT)

The unit calculates the length of the tape and decides which tracks go on which side of the cassette so tracks are not cut off midway.

Preparation: Do the preparatory steps (➔ page 19).
Insert a CD.

Press [AI EDIT].

The unit makes the calculations and "AI EDIT TAPE" scrolls across the display. It takes a moment for recording to start.

After the deck completes recording the CD

It goes into recording standby mode. If there is space left on the tape, "LINK" and the remaining time on the tape flash on the display.

If you have completed recording, press [] on the deck or the CD player.

If you wish to continue recording with another CD, see "Linking" below.

A

AI EDIT



B

1

OPEN/CLOSE



2



To stop editing

Press [] on the deck or the CD player.
"EDIT OUT" is displayed and both sections stop.

When tracks are allotted to both sides

When the tracks allotted to side A finish playing, the deck records to the end of the side to complete calculation.

Editing programmed tracks

Program the tracks (➔ step 1 and 2, page 18) and press [AI EDIT].

Note

Track numbered 25 or over cannot be recorded by one touch editing. Use normal recording (➔ page 20).

B Linking

If "LINK" is flashing and you wish to continue recording from another CD, do the following.

1 Press [▲ OPEN/CLOSE] and insert another CD.

Press [▲ OPEN/CLOSE] to close the tray.

2 Press [▶] on the CD player.

Recording begins again.

You can continue linking tracks as long as there is space on the tape. If you load a CD that has no tracks short enough to fit in the remaining space, linking cannot be done.

To cancel

Press [] on the deck or the CD player.
"EDIT OUT" scrolls across the display.

Linking programmed tracks

Program tracks after inserting the new CD (➔ step 1 and 2, page 18).

Your attention is drawn to the fact that recording pre-recorded tapes or discs or other published or broadcast material may infringe copyright laws.

Using the timers

The play timer

This timer starts play of the selected source at the selected time. The example shows settings for preset radio channel 3 to play between 6:30 and 7:40, Monday to Friday at -40 dB.

Preparation: Turn the unit on, set the time (➔ page 11), preset radio stations if you want the timer to start playing the radio (➔ page 13).

- 1 **Press [CLOCK/TIMER, -DEMO] to select “⏪ PLAY.”**

CLOCK → ⏪ PLAY → ⏪ REC → Original display

- 2 **Press [SET] within 15 seconds.**

- 2 **Press [TUNE/TIME ADJUST (or)] to select the condition required and**

- 2 **press [SET].**

Repeat steps 1 and 2 to complete items 1 to 5.

- 1 **Select the day.**

“SUN” ... “SAT” = One day of the week.

“SUN TO SAT” = Everyday of the week.

“MON TO SAT” = Everyday from Monday to Saturday.

“MON TO FRI” = Everyday from Monday to Friday.

“SAT, SUN” = Saturday and Sunday only.

- 2 **Select the start time.**

- 3 **Select the finish time.**

- 4 **Select the source.**

TUNER ↔ CD ↔ TAPE

If you select TUNER

Select a preset channel.

- 5 **Select the volume.**

The timer is now on standby. The display shows each condition again for 3 seconds each then restores the original display.

Confirm the indicator next to [⏪ PLAY/⏪ REC] lights and “⏪ PLAY” on the display.

- 3 **Press [⏪ /I] to turn the unit off.**

The timer starts at the set time with the volume increasing gradually to the set level.

To cancel the timer

Turn the unit on.

On the remote control

Press [⏪ PLAY] so “⏪ PLAY” goes out.

On the main unit

Press [⏪ PLAY/⏪ REC] so “⏪ PLAY” goes out.

Each time you press the button:

⏪ PLAY ⏪ REC ⏪ PLAY ⏪ REC off (no display)

The timer function will be canceled, but the settings stay in the memory.

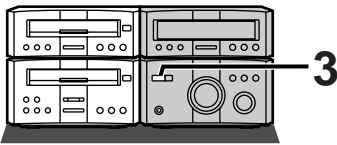

⏪ PLAY/⏪ REC

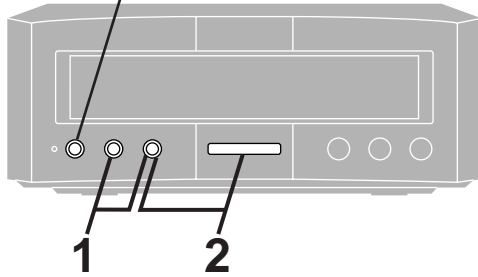

1

- 1 CLOCK/TIMER



- 2 SET



2

- 1

TUNE/TIME ADJUST

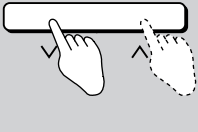

- 2

SET

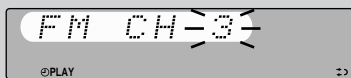
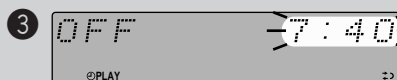
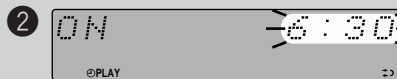

3

⏪ /I

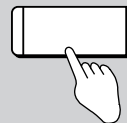

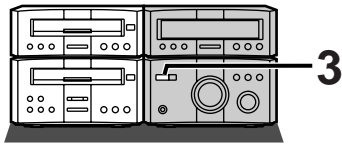

⏪ PLAY/⏩ REC

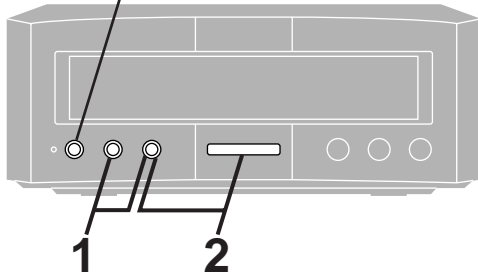

Using the timers

The record timer

This timer records the radio at the set time.

The example shows settings for recording preset channel 3 on Saturday from 18:30 to 19:30.

Preparation: Turn the unit on, set the time (➔ page 11), preset radio stations (➔ page 13).

- 1** ① Press [CLOCK/TIMER, -DEMO] to select "⏪ REC".

CLOCK → ⏪ PLAY → ⏪ REC → Original display

- ② Press [SET] within 15 seconds.

- 2** ① Press [TUNE/TIME ADJUST (or)] to select the condition required and ② press [SET].

Repeat steps ① and ② to complete items ① to ④.

- ① Select the day.
"SUN" ... "SAT" = One day of the week.
"SUN TO SAT" = Everyday of the week.

- ② Select the start time.

- ③ Select the finish time.

- ④ Select the preset channel.

The timer is now on standby. The display shows each condition again for 3 seconds each then restores the original display.

Confirm the indicator next to [⏪ PLAY/⏩ REC] lights and "⏪ REC" on the display.

- 3** Press [⏻/⏻] to turn the unit off.

Recording starts 30 seconds before the set time with the volume muted during the set time.

To cancel the timer

Turn the unit on.

On the remote control

Press [⏪ REC] so "⏪ REC" goes out.

On the main unit

Press [⏪ PLAY/⏩ REC] so "⏪ REC" goes out.

Each time you press the button:

⏪ PLAY ⏪ REC ⏪ PLAY ⏪ REC off (no display)

The timer function will be canceled, but the settings stay in the memory.

- 1** ① CLOCK/TIMER

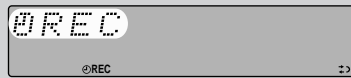

- ② SET



- 2**

- ①

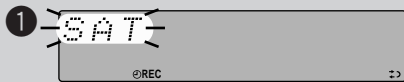
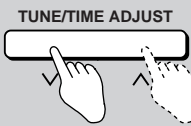

- ②

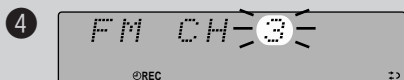
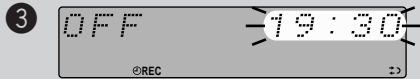
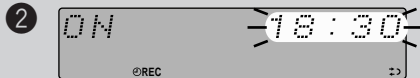

- 3**

⏻/⏻

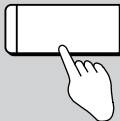

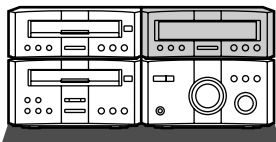

A

[⏪ PLAY/⏩ REC] indicator

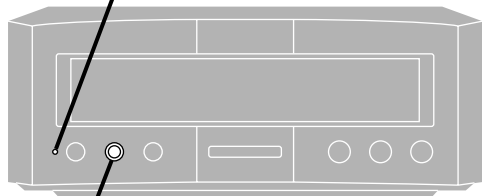

CLOCK/TIMER, -DEMO

CLOCK/TIMER



- DEMO

B

SLEEP

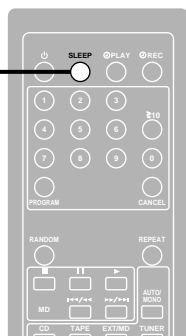

SLEEP



Using the timers

A The play and record timers

Checking the timers

Press [CLOCK/TIMER, -DEMO] to select “⏪ PLAY” (or “⏩ REC”) The timer conditions are shown in the following order:
Day start time finish time source (“⏪ PLAY” only) volume

The timers can be checked even if the unit is off.

Playing the unit after the timers are set

The unit can be used after the timers are set. Make sure the unit is off before the set start time.

Note

If the unit is turned off while a timer is functioning, the finish time setting will not be activated.

The timers (either one or both) are set when the [⏪ PLAY/⏩ REC] indicator is on.

B The sleep timer

Remote control only

This timer turns the unit off after a set time.

While playing a source

Press [SLEEP] to select the time (minutes).

Each time you press the button:

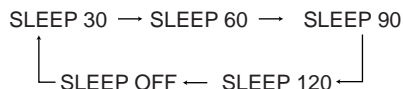

To cancel the sleep timer

Press [SLEEP] to select “SLEEP OFF.”
“SLEEP” goes out.

To confirm the remaining time

(While the timer is functioning)

Press [SLEEP].

The remaining time is shown for about five seconds.

To change the setting

Press [SLEEP] to display the remaining time, then press again to select the required time.

Note

The sleep timer is canceled if one touch editing is started.

Using the timers together

Any of the timers can be used together, but ensure the unit is off before the start time for the record and play timers.

Using other equipment

A Listening to an external source

1 Press [INPUT SELECTOR] to select EXT/MD mode.

Each time you press [INPUT SELECTOR]:

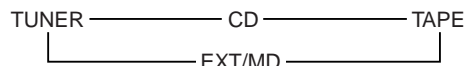

On the remote control

Press [EXT/MD].

2 Operate the unit.

See the unit's manual for details on operation and connection (➔ page 8).

B Enjoying sound from a DVD player

SC-HD510 only

Select the DVD mode to enjoy high quality from a DVD player connected to the EXT/MD IN terminals.

Press and hold [INPUT SELECTOR ▲, -DVD DIRECT] until "DVD" is displayed.

To cancel

Press [INPUT SELECTOR] to select another source.

Note

The DVD mode is designed specifically for use with DVD player. The volume level will change if you select this mode while equipment other than a DVD player is connected.

Recording an external source

① Press [INPUT SELECTOR] to select EXT/MD mode.

② Select Dolby NR and reverse mode.

③ Press [REC PAUSE].

④ Press [◀] or [▶] to start recording.

⑤ Start the source to be recorded.

See the unit's manual for details on operation and connection.

To stop recording

Press [] on the deck.

Recording onto an external unit

Start recording on the external unit and start playing the source to be recorded.

C Using headphones (not included)

Reduce the volume before connection.

Avoid listening for prolonged periods of time to prevent hearing damage.

Plug type: 3.5 mm stereo.

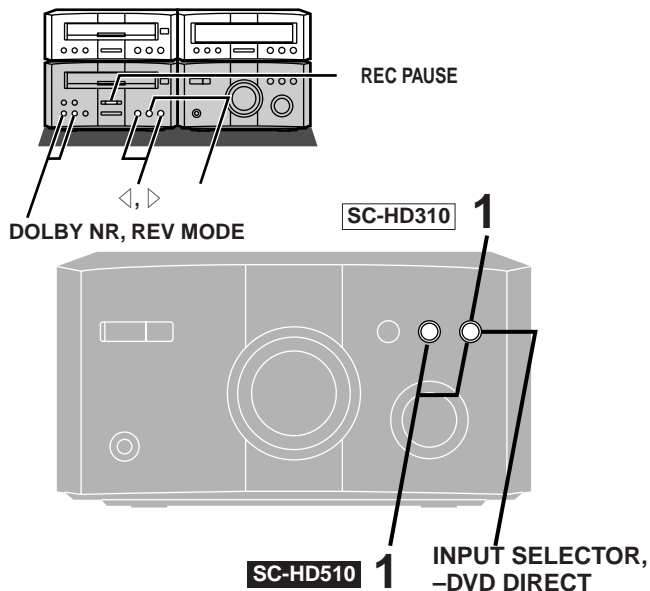

A

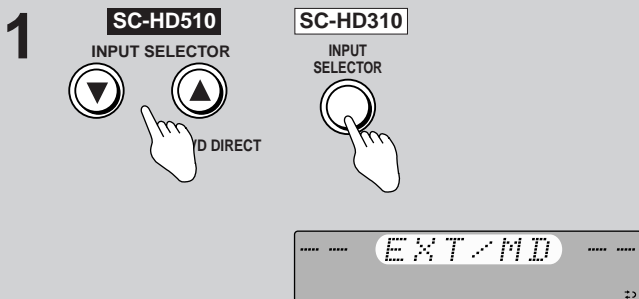

B

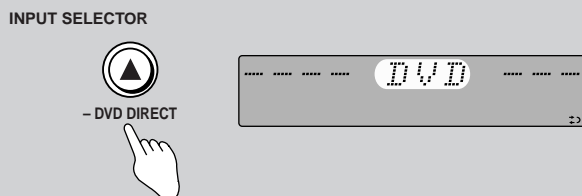

C

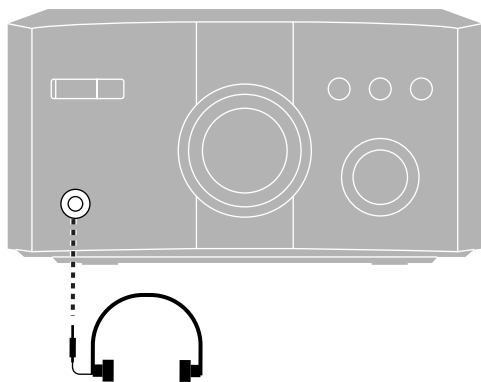

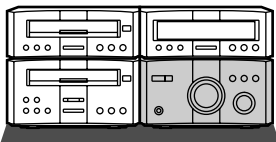

SC-HD510

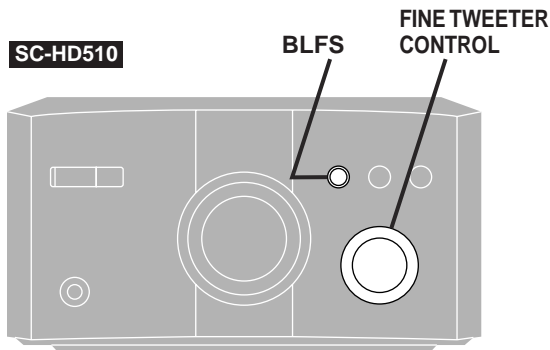

A FINE TWEETER CONTROL

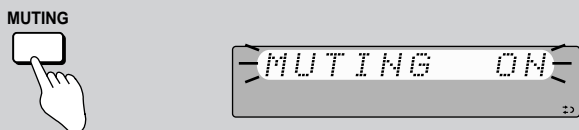
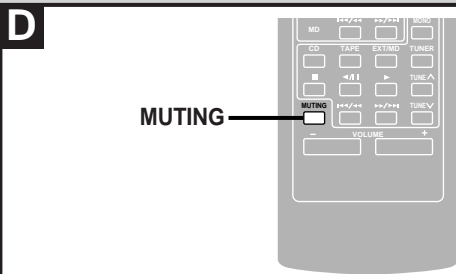
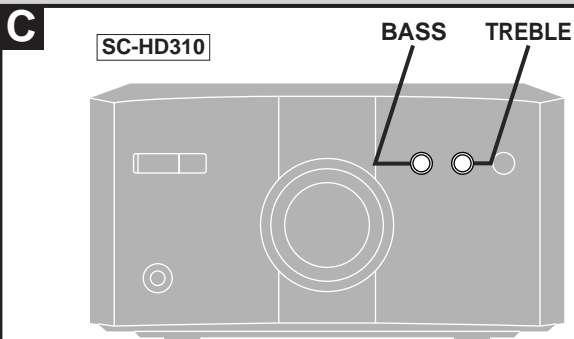
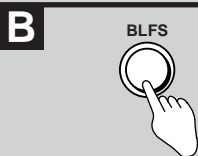

Convenient functions

A Adjusting the treble range

SC-HD510 only

Fine adjustments to the treble range can be made due to separation of the tweeter and woofer.

Turn [FINE TWEETER CONTROL].

Turn towards MAX to emphasize the treble or towards MIN to lessen the effect.

Note

The effect is not noticeable through headphones.

B Adjusting the bass-BLFS

SC-HD510 only

Use this feature to emphasize the bass (HIGH or LOW), or weaken it (LIGHT).

Press [BLFS].

Each time you press the button:

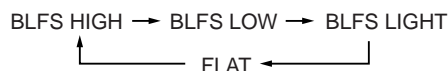

To cancel

Press [BLFS] to select "FLAT."

C To adjust the tone quality

SC-HD310 only

The level can be adjusted between -3 to +3.

Press [BASS] (low-frequency sound) or [TREBLE] (high-frequency sound).

Each time you press the button;

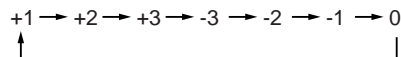

To cancel

Press [BASS] or [TREBLE] to select "BASS 0" or "TREBLE 0". ("FLAT" will light.)

D Muting the volume

Remote control only

Press [MUTING].

Volume is reduced to minimum.

To cancel

Press [MUTING] again. ("MUTING OFF" lights up.)

To cancel from the unit, turn [VOLUME] to minimum (- - dB), then raise it to the required level.

Muting is also canceled when the unit is turned off.

Maintenance

If the surfaces are dirty

To clean this unit, wipe with a soft, dry cloth.

If the surfaces are extremely dirty, use a soft cloth dipped in a soap-and-water solution or a weak detergent solution.

Never use alcohol, paint thinner or benzine to clean this unit.

Before using chemically impregnated cloth, read the instructions that came with the cloth carefully.

For a cleaner crisper sound

Clean the heads regularly to assure good quality playback and recording. Use a cleaning tape (not included).

Troubleshooting guide

Before requesting service, make the below checks. If you can't fix the system as described below, or if something not listed here occurs, refer to the enclosed directory to locate an Authorized Service Center convenient to you or contact your dealer.

Reference pages are shown as black circled numbers ⑥.

Common Problems

No sound.	Turn the volume up. The speaker cords may be shorted. Turn the unit off, check and correct the connections and turn the unit on. ⑥
Sounds unfixed, reversed or come from one speaker only	Check the speaker connections. ⑥
Humming heard during play	An AC mains lead or fluorescent light is near the cables. Keep other appliances and leads away from this unit's cables. If possible in your area, turn the AC mains lead's plug or connector over to reverse the lead's polarity.
"ERROR" is displayed.	Incorrect operation performed. Read the instructions and try again.
"U70" is displayed	Connect the flat cables firmly. If "U70" remains on the display, contact the dealer.
"F61" is displayed.	There is a problem with the amplifier. Consult your dealer.
ECO mode on but display still lights up in standby mode.	Turn DEMO off. ⑩

Listening to the radio

Noise is heard. The stereo indicator flickers or doesn't light. Sound is distorted.	Use an outdoor antenna. ⑧
A beat sound is heard.	Turn the TV off or separate it from the unit.
A low hum is heard during AM broadcasts.	Separate the antenna from other cables and leads.
The correct AM frequency can't be tuned in.	Change the frequency step. Hold [FM/AM] or [AM] down for 10 seconds to change the step to 9 kHz.

The cassette deck

Poor quality sound.	Clean the heads. ⑳ Check the Dolby NR setting. ⑭
Recording is not possible.	If the erasure prevention tabs have been removed, cover the holes with adhesive tape. ⑲

The CD player

The display is wrong or play won't start.	The disc may be upside down. ⑮ Wipe the disc. Replace the disc if it is scratched, warped, or nonstandard. ⑮ Condensation may have formed in the player due to a sudden change in temperature. Wait about an hour for it to clear and try again.
---	---

During "One touch" editing (⇒ Page 21)

"NO TAPE" is displayed.	Load a cassette. ⑭
"CHANGE TAPE" is displayed.	If the erasure prevention tabs have been removed, cover the holes with adhesive tape. ⑲

The remote control

The remote control doesn't work.	Check the batteries are inserted correctly. ⑤ Replace the batteries if they are worn.
----------------------------------	--

All components are required to service the system. If service is ever necessary, bring the entire system.

Technical specifications (DIN 45 500)

TUNER

Pre-amplifier section	
Input sensitivity/impedance	
EXT/MD IN	300 mV/15 k Ω
Output level/impedance	
EXT/MD OUT	250 mV/1.5 k Ω
Tuner section	
FM frequency range	87.50–108.00 MHz (0.05 MHz step)
FM antenna terminal	75 Ω unbalance
AM frequency range	
	522–1629 kHz (9 kHz step)
	520–1630 kHz (10 kHz step)
Timer section	
Clock	Quartz lock type
Function	Play timer: 1 time or everyday
	Rec timer: 1 time or everyday
	Sleep timer: 120 min, 30 min intervals

GENERAL

Dimensions (W x H x D)	196 x 76.8 x 250 mm
Weight	1.0 kg

AMPLIFIER SC-HD510

Amplifier section (Low frequency side)	
Power output	
DIN 1 kHz, THD 1%, 6 Ω both channel driven	2 x 12 W
RMS 1 kHz, THD 10%, 6 Ω both channel driven	2 x 15 W
Total harmonic distortion	
Half power, 1 kHz, 6 Ω	0.09%
S/N	75 dB
Load impedance	6 Ω
Amplifier section (High frequency side)	
Power output	
DIN 10 kHz, THD 1%, 6 Ω both channel driven	2 x 5 W
RMS 10 kHz, THD 10%, 6 Ω both channel driven	2 x 8 W
S/N	75 dB
Load impedance	6 Ω
Headphones	
Jack type	3.5 mm STEREO
Load impedance	16–32 Ω
General	
Power supply	
For United Kingdom, Australia and N.Z.	AC 230–240 V, 50 Hz
For others	AC 230 V, 50 Hz
Power consumption	73 W
STANDBY condition	
Normal	9 W
Eco	0.8 W
Dimensions (W x H x D)	196 x 105.8 x 259.9 mm
Weight	3.3 kg

AMPLIFIER SC-HD310

Amplifier section	
Power output	
DIN 1 kHz, THD 1%, 6 Ω both channel driven	2 x 17 W
RMS 1 kHz, THD 10%, 6 Ω both channel driven	2 x 20 W
Total harmonic distortion	
Half power, 1 kHz, 6 Ω	0.09 %
Frequency response	50 Hz–20 kHz (+1 dB, –3 dB)
S/N	75 dB
Load impedance	6 Ω
Headphones	
Jack type	3.5 mm STEREO
Load impedance	16–32 Ω
General	
Power supply	
For United Kingdom	AC 230–240 V, 50 Hz
For others	AC 230 V, 50 Hz
Power consumption	67 W
STANDBY condition	
Normal	9 W
Eco	0.8 W

Dimensions (W x H x D)

Weight	196 x 105.8 x 259.9 mm
	2.8 kg

CD PLAYER

Digital output terminal	Optical x 1
Audio section	
DA converter	1 bit 2 DAC MASH
Format	
Sampling frequency	44.1 kHz
Pickup	
Wavelength	780 nm
General	
Dimensions (W x H x D)	196 x 76.8 x 243.1 mm
Weight	1.2 kg

CASSETTE DECK

Audio section	
Track system	4 track 2 channel STEREO
Frequency response (Dolby NR off)	
(Rec/Play)	
TYPE I (NORMAL)	30 Hz–16 kHz (DIN)
TYPE II (HIGH)	30 Hz–16 kHz (DIN)
TYPE IV (METAL)	30 Hz–16 kHz (DIN)
S/N (Signal level=max recording level, TYPE II)	
NR off	56 dB (A weighted)
Dolby B NR	64 dB (A weighted)
Motor	
Capstan drive	DC servo motor
Reel table drive	DC motor
Fast forward and rewind time (C-60)	Approx. 52 seconds
Wow and flutter	0.1% (WRMS)
General	
Dimensions (W x H x D)	196 x 105.8 x 236.1 mm
Weight	1.5 kg

SPEAKER SYSTEM SC-HD510

Type	2 way, 2 speaker, bass-reflex system	
Speaker(s)		
Woofer:	12 cm cone type	
Tweeter:	6 cm semi-dome type	
Impedance	6 Ω	
Input power		
High	30 W (Music), 15 W (DIN)	
LOW	60 W (Music), 30 W (DIN)	
Output sound pressure level	85 dB/W (1.0 m)	
Cross over frequency	5 kHz	
Frequency range	43 Hz–50 kHz (–16 dB)	
	50 Hz–45 kHz (–10 dB)	
General		
Dimensions (W x H x D)		
For Australia and N.Z.		
	155 x 334 x 240 mm	
For others	155 x 334 x 252 mm	
Weight		
For Australia and N.Z.	3.1 kg	
For others	3.5 kg	

SPEAKER SYSTEM SC-HD310

Type	2 way, 2 speaker, bass-reflex system	
Speaker(s)		
Woofer:	12 cm cone type	
Tweeter:	6 cm cone type	
Impedance	6 Ω	
Input power	60 W (Music), 30 W (DIN)	
Output sound pressure level	85 dB/W (1.0 m)	
Cross over frequency	6 kHz	
Frequency range	45 Hz–25 kHz (–16 dB)	
	55 Hz–22 kHz (–10 dB)	
General		
Dimensions (W x H x D)		
	160 x 319 x 217 mm	
Weight	3.0 kg	

Notes:

- Specifications are subject to change without notice. Weight and dimensions are approximate.
- Total harmonic distortion is measured by the digital spectrum analyzer.

Free Manuals Download Website

<http://myh66.com>

<http://usermanuals.us>

<http://www.somanuals.com>

<http://www.4manuals.cc>

<http://www.manual-lib.com>

<http://www.404manual.com>

<http://www.luxmanual.com>

<http://aubethermostatmanual.com>

Golf course search by state

<http://golfingnear.com>

Email search by domain

<http://emailbydomain.com>

Auto manuals search

<http://auto.somanuals.com>

TV manuals search

<http://tv.somanuals.com>