

Technics

Compact Disc Changer SL-PD947

Operating Instructions

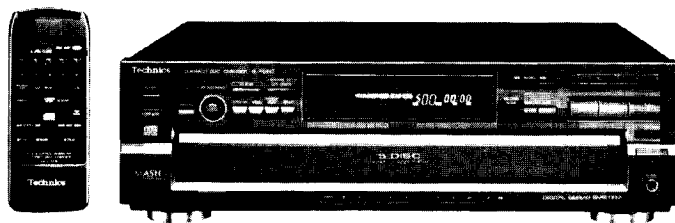

Before connecting, operating or adjusting this product, please read these instructions completely.

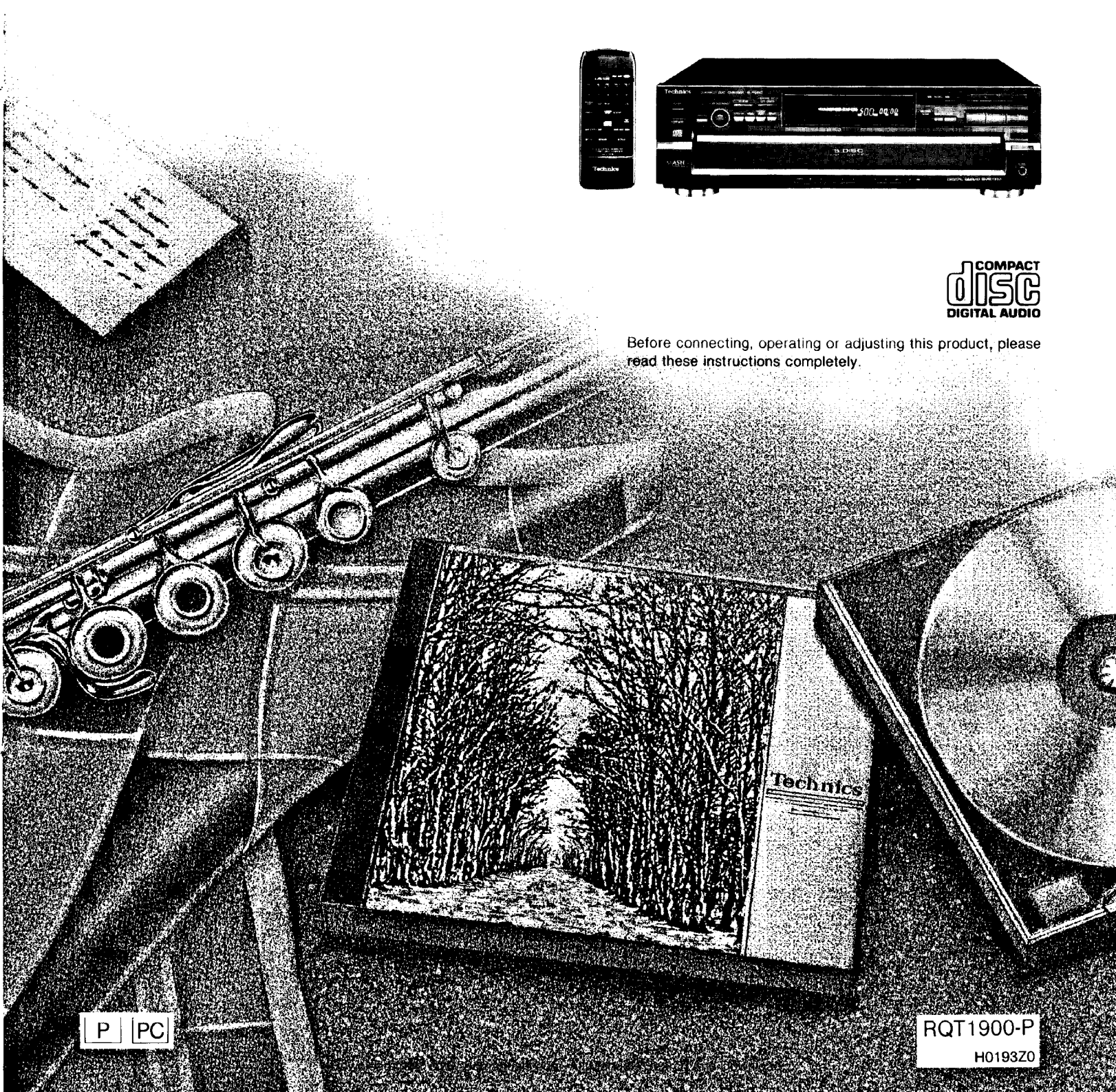

P | PC

RQT1900-P
H0193Z0

Thank you for purchasing this Technics product.
 For optimum performance and safety, please read
 these instructions carefully.

Table of Contents

Before Use

Precautions	3
Safety	3
Installation	3
Maintenance	3
Service	3
Preparations	4
Supplied accessories	4
Connections	4
Concerning the Remote Control	5
Battery installation	5
Use of batteries	5
Operation notes	5
Front Panel Controls and Functions	6
Control section	6
Display section	8

Listening

Basic Operating Procedure	9
Sequential Play	10
When listening through headphone	11
Direct Access Play	12
From the main unit	12
From the remote control	13
Program Play	14
From the main unit	14
From the remote control	16
Delete Play	18
From the main unit	18
From the remote control	20

Random Play	22
One disc random play	22
Full random play	23
Spiral Play	24
Special Features	25
ID scan function	25
Pitch control function	26
Auto cue function	27
Repeat function	28
Search function	28
Skip function	29
Time mode selection	30

Recording

CD Edit-Recording	31
Sequential-edit-recording	32
Program-edit-recording	34

Reference

Before Moving	35
Quick Reference Table of Remote Control Operation	36
Concerning Compact Discs	38
Handling precautions	38
Storage precautions	38
Technical Specifications	38
Troubleshooting Guide	39
Product Service	39
Product information	39
Index	Back Cover

The model number and serial number of this product can be found on either the back or the bottom of the unit. Please note them in the space provided below and retain them for future reference.

MODEL NUMBER SL-PD947

SERIAL NUMBER _____

CAUTION:
 TO PREVENT ELECTRIC SHOCK MATCH WIDE BLADE OF PLUG TO WIDE SLOT, FULLY INSERT.

WARNING:
 TO REDUCE THE RISK OF FIRE OR ELECTRIC SHOCK, DO NOT EXPOSE THIS APPLIANCE TO RAIN OR MOISTURE.



CAUTION: TO REDUCE THE RISK OF ELECTRIC SHOCK, DO NOT REMOVE SCREWS. NO USER-SERVICEABLE PARTS INSIDE. REFER SERVICING TO QUALIFIED SERVICE PERSONNEL.

The lightning flash with arrowhead symbol, within an equilateral triangle, is intended to alert the user to the presence of uninsulated "dangerous voltage" within the product's enclosure that may be of sufficient magnitude to constitute a risk of electric shock to persons.

The exclamation point within an equilateral triangle is intended to alert the user to the presence of important operating and maintenance (servicing) instructions in the literature accompanying the appliance.

Precautions

Before using this unit please read these operating instructions carefully. Take special care to follow the warnings indicated on the unit itself as well as the safety suggestions listed below. Afterwards keep them handy for future reference.

Safety

- 1. Power Source** -- The unit should be connected to power supply only of the type described in the operating instructions or as marked on the unit.
- 2. Polarization** -- If the unit is equipped with a polarized AC power plug (a plug having one blade wider than the other), that plug will fit into the AC outlet only one way. This is a safety feature. If you are unable to insert the plug fully into the outlet, try reversing the plug. If the plug should still fail to fit, contact your electrician to replace your obsolete outlet. Do not defeat the safety purpose of the polarized plug.
- 3. Power Cord Protection** -- AC power supply cords should be routed so that they are not likely to be walked on or pinched by items placed upon or against them. Never take hold of the plug or cord if your hand is wet, and always grasp the plug body when connecting or disconnecting it.
- 4. Nonuse Periods** -- When the unit is not used, turn the power off. When left unused for a long period of time, the unit should be unplugged from the household AC outlet.

Installation

Environment

- 1. Water and Moisture** -- Do not use this unit near water—for example, near a bathtub, washbowl, swimming pool, or the like. Damp basements should also be avoided.
 - 2. Condensation** -- Moisture may form on the lens in the following cases...
 - immediately after a heater has been turned on.
 - in a steamy or very humid room.
 - when the unit is suddenly moved from a cold environment to a warm one.
- If moisture forms inside this unit, it may not operate properly. To correct this problem, turn on the power and wait about one hour for the moisture to evaporate.
- 3. Heat** -- The unit should be situated away from heat sources such as radiators and the like. It also should not be placed in temperatures less than 5°C (41°F) or greater than 35°C (95°F).

Placement

- 1. Ventilation** -- The unit should be situated so that its location or position does not interfere with its proper ventilation. Allow 10 cm (4") clearance from the rear of the unit.
- 2. Foreign Material** -- Care should be taken so that objects do not fall into and liquids are not spilled into the unit. Do not subject this unit to excessive smoke, dust, mechanical vibration, or shock.
- 3. Magnetism** -- The unit should be situated away from equipment or devices that generate strong magnetism.
- 4. Stacking** -- Do not place heavy objects, other than system components, on top of the unit.
- 5. Surface** -- Place the unit on a flat, level surface.
- 6. Carts and Stands** -- The unit should be used only with a cart or stand that is recommended by the manufacturer. The unit and cart combination should be moved with care. Quick stops, excessive force, and uneven surfaces may cause the unit and cart combination to overturn.
- 7. Wall or Ceiling Mounting** -- The unit should not be mounted to a wall or ceiling, unless specified in this operating instructions.



Maintenance

Clean the cabinet, panel and controls with a soft cloth lightly moistened with mild detergent solution.

Do not use any type of abrasive pad, scouring powder or solvent such as alcohol or benzine.

Service

- 1. Damage Requiring Service** -- The unit should be serviced by qualified service personnel when:
 - (a) The AC power supply cord or the plug has been damaged; or
 - (b) Objects have fallen or liquid has been spilled into the unit; or
 - (c) The unit has been exposed to rain; or
 - (d) The unit does not appear to operate normally or exhibits a marked change in performance; or
 - (e) The unit has been dropped, or the enclosure damaged.
- 2. Servicing** -- The user should not attempt to service the unit beyond that described in the operating instructions. All other servicing should be referred to qualified service personnel.

CAUTION:

- This digital apparatus does not exceed the Class B limits for radio noise emissions from digital apparatus set out in the Radio Interference Regulations of the Canadian Department of Communications.

- THIS PRODUCT UTILIZES A LASER. USE OF CONTROLS OR ADJUSTMENTS OR PERFORMANCE OF PROCEDURES OTHER THAN THOSE SPECIFIED HEREIN MAY RESULT IN HAZARDOUS RADIATION EXPOSURE. DO NOT OPEN COVERS AND DO NOT REPAIR YOURSELF. REFER SERVICING TO QUALIFIED PERSONNEL.

Preparations

Supplied accessories

Check the packing carton for these accessories.

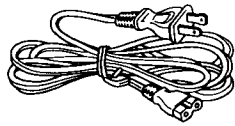

AC power supply cord
(For USA: SJA172-1)
(For Canada: SJA172) 1 pc.

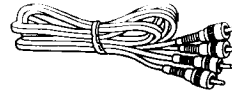

Stereo connection cable
(SJP2249-6) 1 pc.

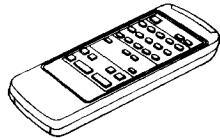

Remote-control transmitter
(RAK-SL002WH) 1 pc.

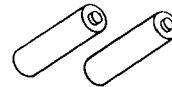

Batteries (UM-4, "AAA", R03) ... 2 pcs.

Connections

Before connecting the changer to your audio system, be sure that the power of the changer and all other system components are turned off.

Rear panel of this changer

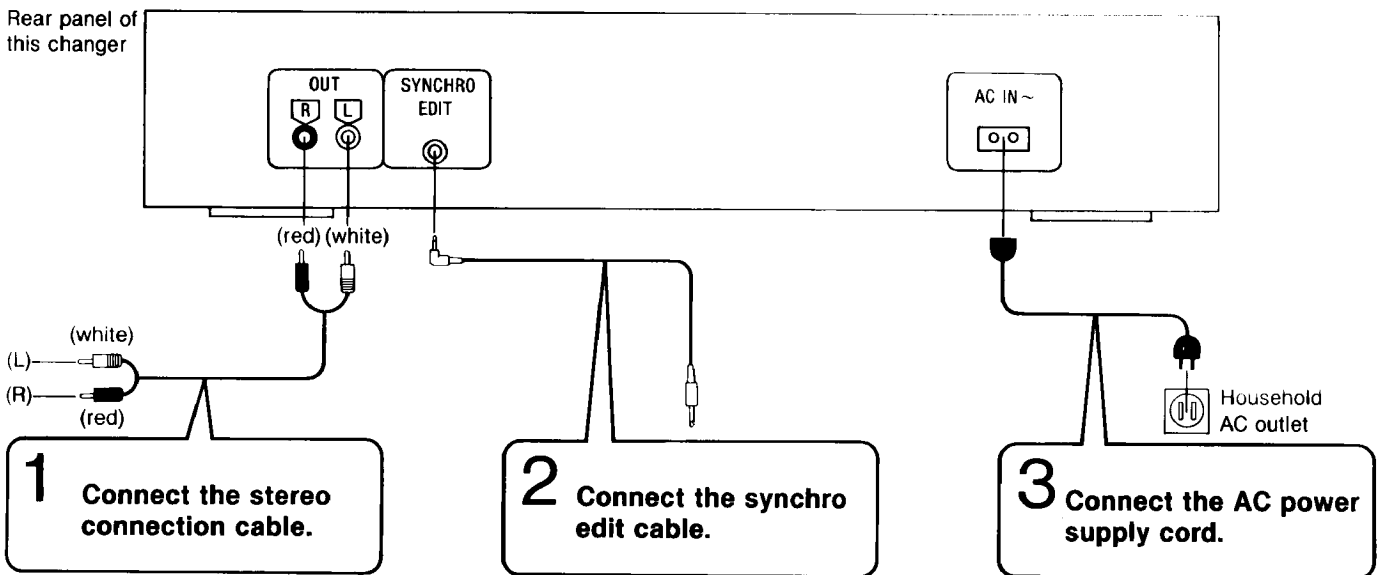

1 Connect the stereo connection cable (included) to CD or AUX terminals of the amplifier or the receiver.

3 Connect the power supply cord (included) to the household AC outlet (AC 120 V, 60 Hz) or to AC OUTLET of Technics component.

2 Connect the synchro edit cable (included with the cassette deck) to SYNCHRO EDIT terminal of Technics cassette deck.

Concerning the Remote Control

Battery installation

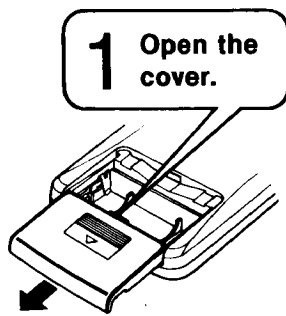

- 1 Open the cover.**
Press gently and slide the cover out.

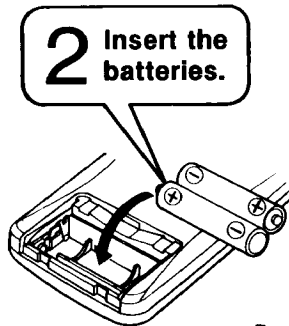

- 2 Insert the batteries included with this unit.**
When you need to replace these batteries, use two UM-4 AAA, IEC R03 (1.5 V) or equivalent batteries.

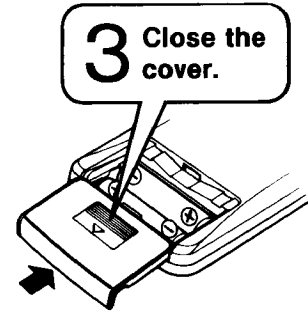

Be sure that you insert the batteries so that their positive (+) and negative (-) polarities match the polarities indicated in the compartment. Batteries installed with incorrect polarities may leak and damage.

Refer to "Use of batteries" for additional information.

- 3 Close the cover.**

Use of batteries

Do not try to mix old and new batteries or batteries of different types (carbon and alkaline, etc.).

Always remove old, weak or worn-out batteries promptly and dispose of them properly.

The average battery life is about one year. Although the battery life varies depending on how often the device is used, you should generally replace the batteries about once a year.

Replace the batteries if commands from the remote control transmitter do not operate the unit even when the transmitter is held close to the front panel.

Never subject batteries to excessive heat or flame; do not attempt to disassemble them; and be sure they are not short-circuited.

If you will not use the remote control for a long period of time, remove the batteries and store them in a cool, dark place.

If a battery leaks, remove all batteries and dispose of them properly. Thoroughly clean the battery compartment before inserting new batteries. If the leaking electrolyte comes into contact with skin or clothes, flush with water immediately.

Keep batteries out of reach of children.

Do not use rechargeable type (nickel-cadmium) batteries.

Do not attempt to recharge alkaline or carbon batteries.

Operation notes

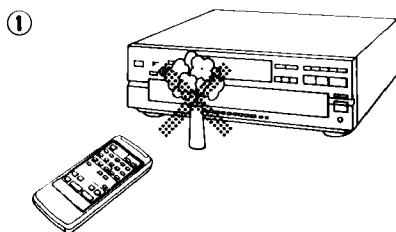

- 1** Aim the remote control transmission window toward the changer's sensor. Avoid any obstacles.

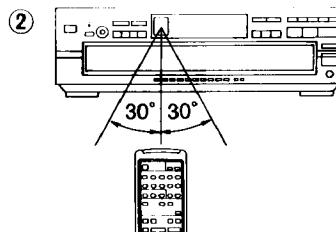

- 2** Use the remote control within a 60-degree angle of the changer.
The reachable distance is within 7 meters (23 ft.) directly facing toward the changer.

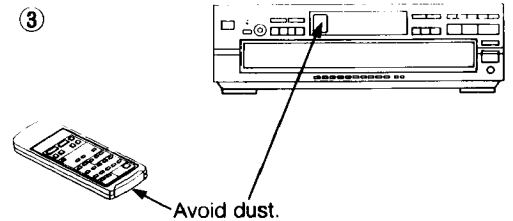

- 3** Be sure the transmission window and the changer's sensor are free from dust. Excessive dust might prevent reception.

If direct sunlight or other strong light sources strike the remote control signal sensor of the changer, operation may be impaired. If there is a problem, place the changer away from the light source.

Front Panel Controls and Functions

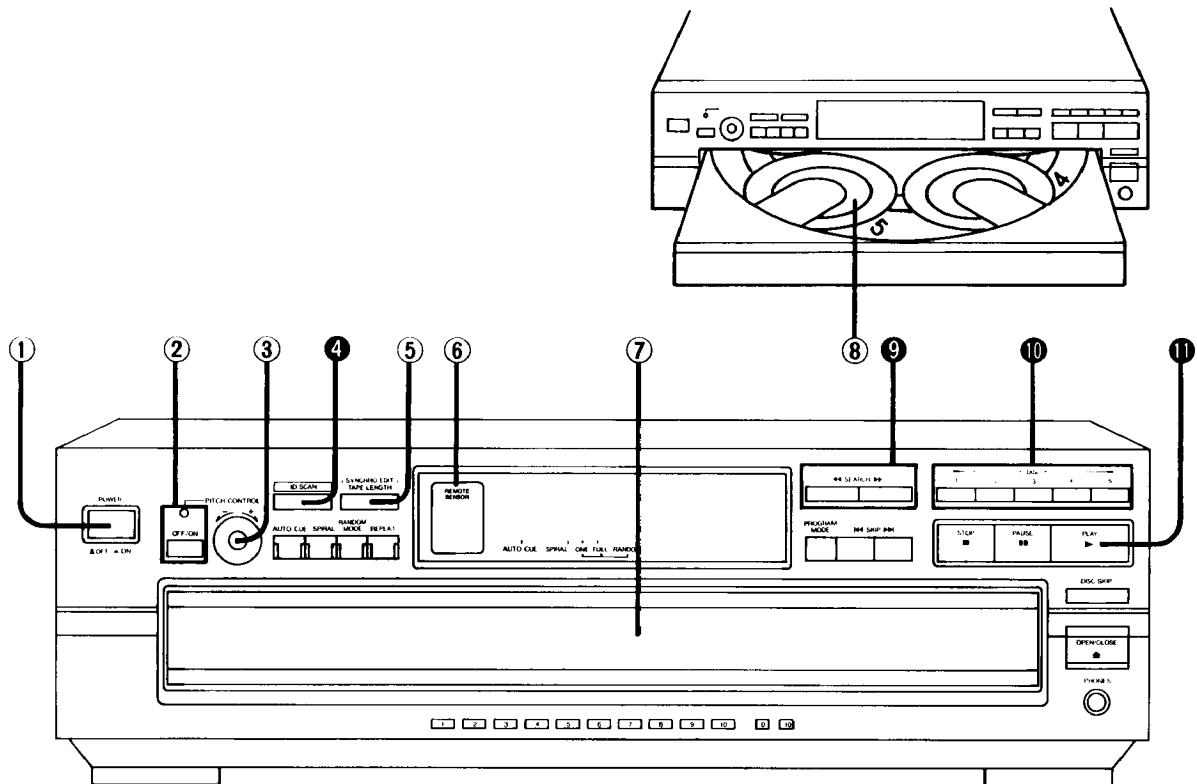

Control section

Numbers with black background (for example ④) indicate functions available on the remote control.

① Power switch (POWER)

Press (→) to switch the power on.
Press again (→) to switch the power off.

② Pitch control button/indicator (OFF/ON)

Press to turn the pitch control effect on or off.
When the pitch control effect is on, the indicator illuminates.
(See page 26.)

③ Pitch control knob (–, +)

This is used to adjust the playback pitch (tempo and pitch of the sound). (See page 26.)

④ ID scan button (ID SCAN)

Press to activate the ID (identify) scan function.
(See page 25.)

⑤ Tape length button (TAPE LENGTH)

When you attempt to record compact discs to tape, press to select the tape length so that the changer can then automatically calculate what tracks fit on each side of the tape, in a sequential manner. (See pages 32–34.)

⑥ Remote control signal sensor (REMOTE SENSOR)

⑦ Loading drawer

You can load or unload discs when this drawer is open.

⑧ Disc trays (1–5)

You can load up to five discs, one disc per one tray.

⑨ Search buttons (◀◀ SEARCH ▶▶)

Press to move forward and backward through the tracks on the disc. (See page 28.)

⑩ Disc buttons (DISC 1–5)

Use to select the desired disc.
With the remote control, by using disc button and numeric button (1–5). (See page 12.)

⑪ Play button (▶ PLAY)

(See page 9.)

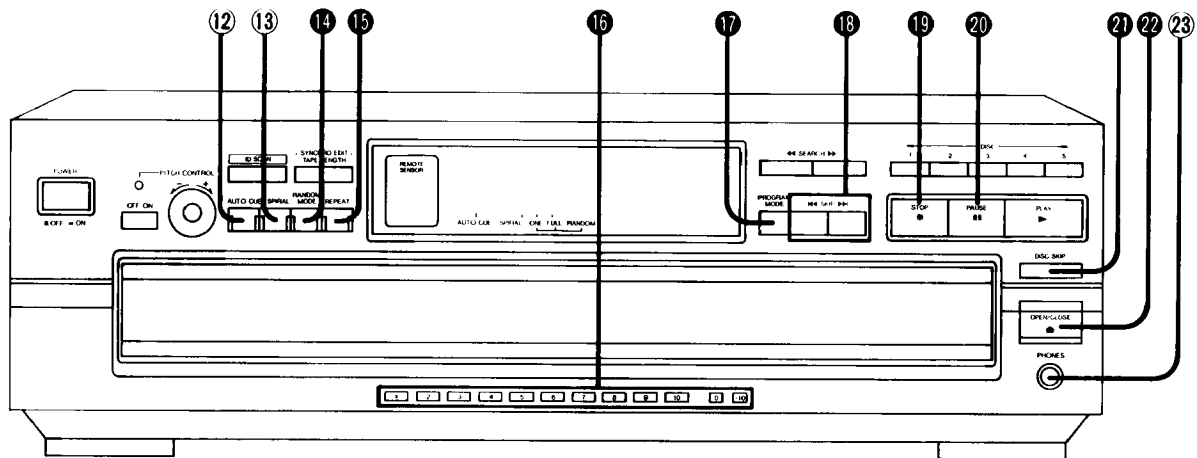

12 Auto cue button (AUTO CUE)

Press to activate the auto cue function.
(See page 27.)

13 Spiral button (SPIRAL)

Press to play the first tracks on all the loaded discs in sequence, followed by the second tracks on all the discs, and so on. (See page 24.)

14 Random mode button (RANDOM MODE)

The mode changes as follows each time the button is pressed.
(See pages 22–23.)

→ sequential → one disc random → full random →

15 Repeat button (REPEAT)

Press to activate the repeat function.
(See page 28.)

16 Numeric buttons (1 – 10, 0, > 10)

Press to select the track number.
(See page 12.)

17 Program mode button (PROGRAM MODE)

The mode changes as follows each time the button is pressed.
(See pages 14, 18.)

→ sequential → program → delete →

18 Skip buttons (|◀◀ SKIP ▶▶|)

Use to skip to the beginning of the track. (See page 29.)

19 Stop button (■ STOP)

(See page 11.)

20 Pause button (|| PAUSE)

(See page 11.)

21 Disc skip button (DISC SKIP)

Use to rotate the disc tray. (See pages 10, 29.)

22 Loading drawer open/close button (▲ OPEN/CLOSE)

23 Headphones jack (PHONES)

(See page 11.)

Front Panel Controls and Functions

(continued)

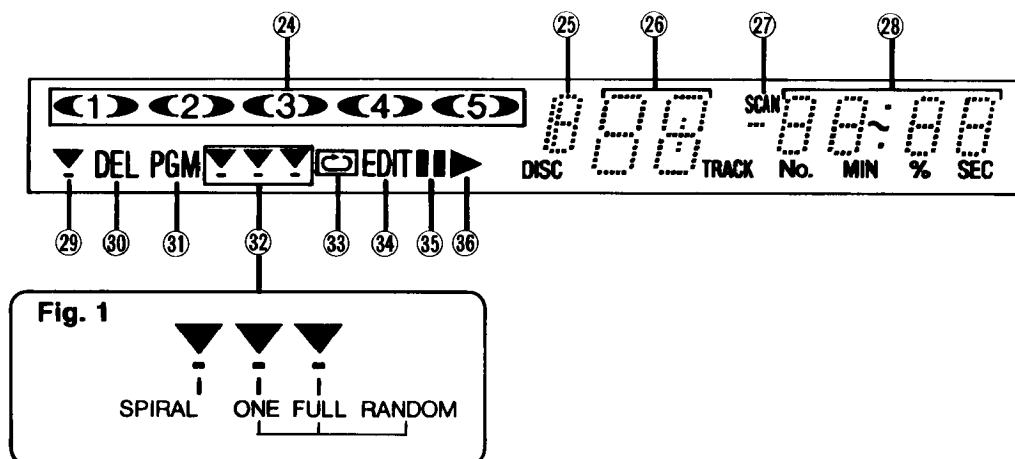

Display section

②④ Disc indicators (<1> ~ <5>)

The indicator corresponding to the playing disc flashes. In the program play mode, programmed disc indicators will illuminate. In the delete play mode, disc indicators to be deleted will go out.

②⑤ Disc number/tape side display

Shows the number (1-5) of the current disc, or shows the tape side (A or B) in the CD edit-recording mode.

②⑥ Track number display

Shows the current track number (up to 99), and also shows "+" or "-" when you operate the pitch control knob.

②⑦ ID scan indicator (SCAN)

Lights in the ID scan mode.

②⑧ Time/program sequence/pitch display

Shows the elapsed playing time of the track in play. Also shows the program sequence in the program play mode, and the sequence you entered in the delete play mode. When you operate the pitch control knob, shows the pitch percentage.

②⑨ Auto cue indicator (▾)

Lights in the auto cue mode.

③⑩ Delete play indicator (DEL)

Lights in the delete play mode.

③① Program play indicator (PGM)

Lights in the program play mode.

③② Play mode indicators (▾ ▾ ▾) (Fig. 1)

Each indicator points to the following play modes:

SPIRAL: Spiral play
ONE: One disc random play
FULL: Full random play

③③ Repeat indicator (☺)

Lights in the repeat mode.

③④ Compact disc edit indicator (EDIT)

Lights in the CD edit-recording mode is activated.

③⑤ Pause indicator (⏸)

Lights in the pause mode.

③⑥ Play indicator (▶)

Lights in the play mode.

Basic Operating Procedure

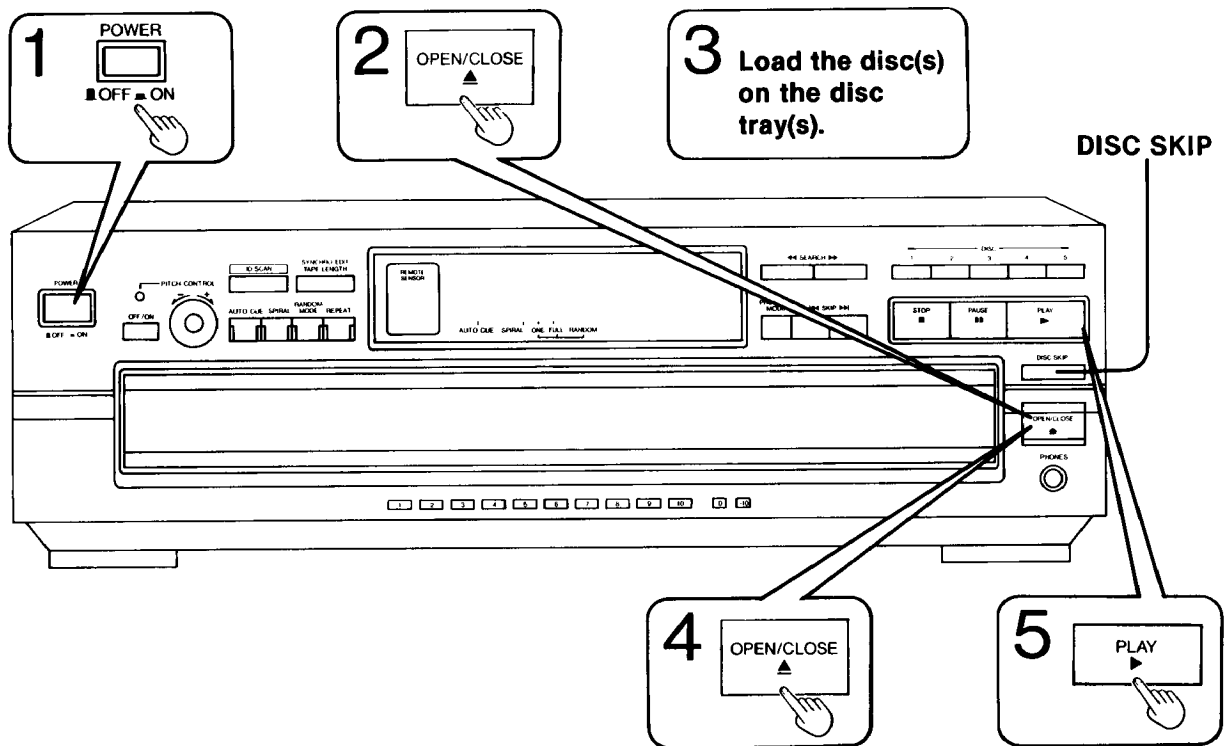

1 Press POWER to switch on the power.

2 Press OPEN/CLOSE to open the loading drawer.
(Also available from the remote control.)

3 Load the disc(s) on the disc tray(s).
Do not load 3" (8 cm) and 5" (12 cm) discs on the same disc tray.
The number (1-5) on the disc tray indicates the disc number.

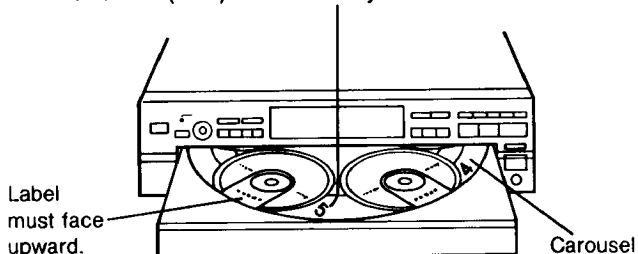

After loading discs on the two disc trays at the front position, press DISC SKIP to move the carousel. A different two disc trays will be at the front position each time DISC SKIP is pressed.

Notes:

Do not touch the carousel nor the loading drawer while it is moving.
Do not turn the carousel forcibly by hand because it may fail to operate normally.

4 Press OPEN/CLOSE again to close the loading drawer.
(Also available from the remote control.)

You can skip this step by pressing PLAY.
The loading drawer will be closed automatically then play will start.

Do not attempt to close the drawer by hand. Be sure to press OPEN/CLOSE.

5 Press PLAY.
(Also available from the remote control.)

CAUTION:

Do not move this changer with a compact disc inside the unit. If a disc comes off the disc tray, it might be scratched or the changer might become incapable of playing. Refer to page 35 before moving the unit.

Sequential Play

Sequential play involves playing all the five discs on the five-disc tray in sequence beginning with the first track on the disc at the playing position.

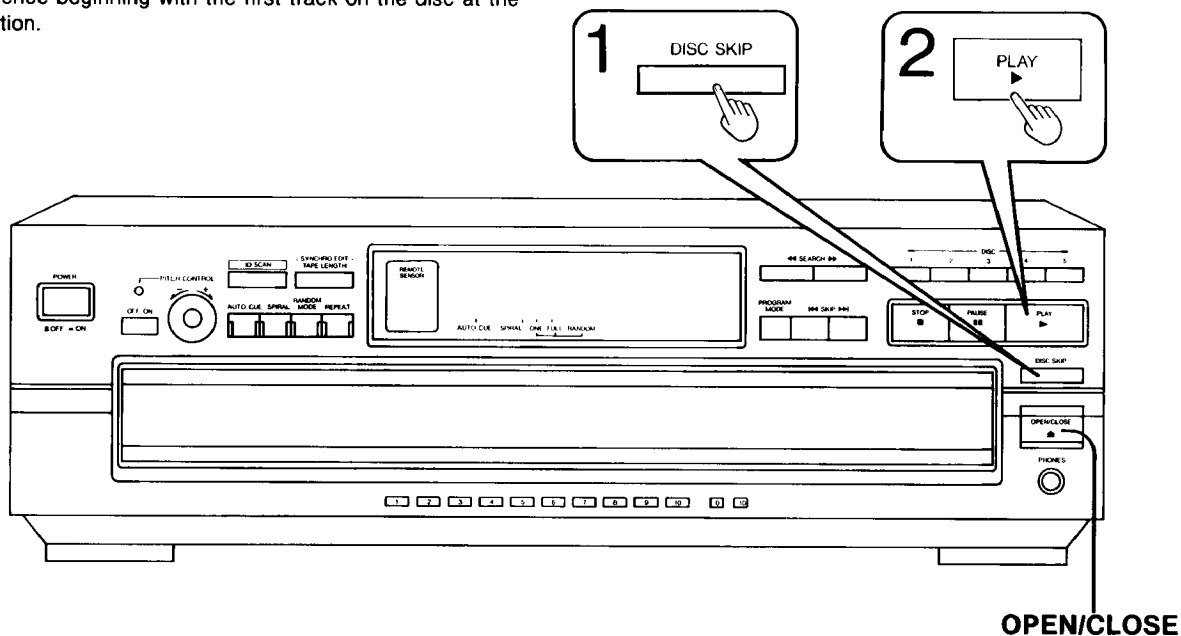

Before operation, follow the steps 1 – 4 of “Basic Operating Procedure” on page 9.

- 1 **Press DISC SKIP to select the desired disc.**
(Also available from the remote control.)
Pressing DISC SKIP will move the carousel by one position.

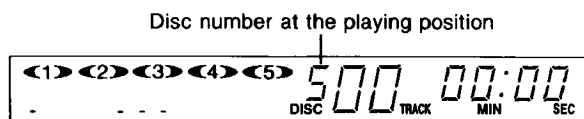

- 2 **Press the play button.**
(Also available from the remote control.)
The play indicator will illuminate and sequential play will start.

The disc indicator corresponding to the disc being played flashes.

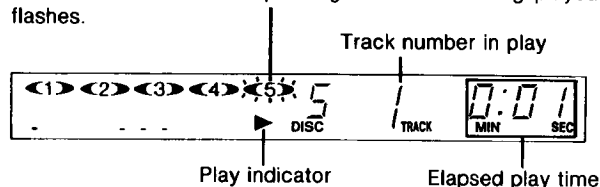

The changer plays all the tracks on all the discs in order and stops automatically when the last track on the last disc finishes playing.

The first disc will be at the playing position.

To exchange discs during play

- 1 **Press OPEN/CLOSE to open the loading drawer.**
- 2 **Press DISC SKIP to rotate the disc trays and exchange the discs.**
The carousel will move by one position. Pressing again moves the carousel in the opposite direction by two disc trays.
- 3 **Press OPEN/CLOSE to close the loading drawer.**

If you play a disc with the loading drawer open, the changer will stop when the last track on the current disc finishes playing.

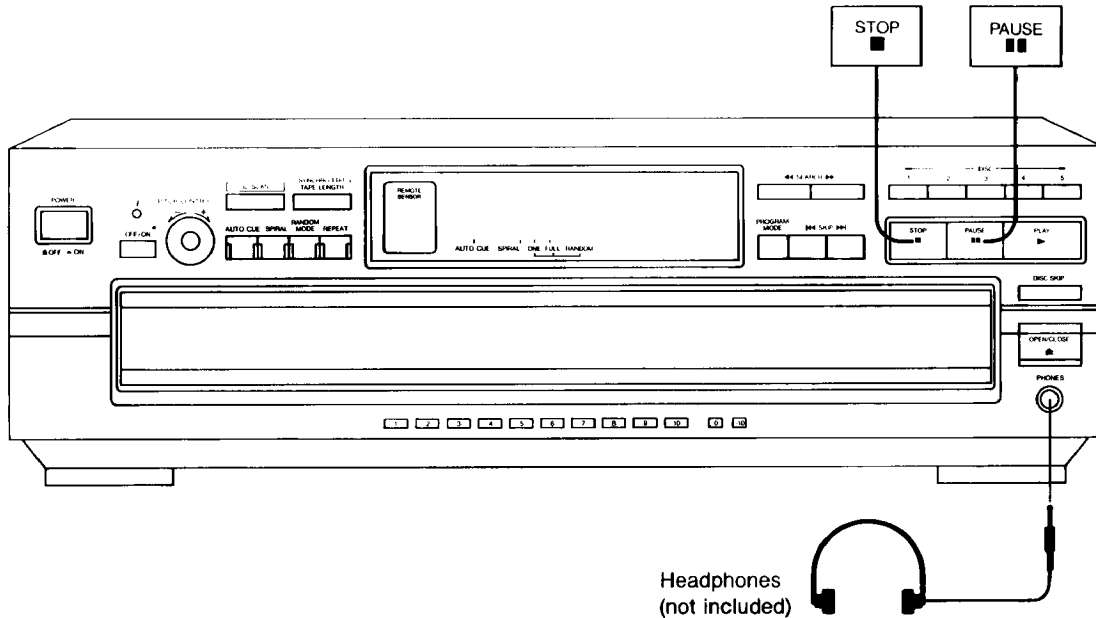

To temporarily stop play (Also available from the remote control.)

Press **PAUSE**.

Press **PLAY** or **PAUSE** to resume play.

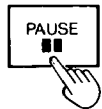

This switches the changer to the pause mode, and the pause indicator illuminates. The disc rotates while the changer is in the pause mode.

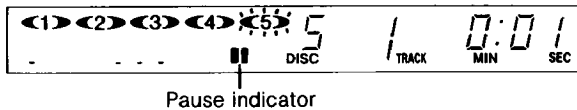

To stop play (Also available from remote control.)

Press **STOP**.

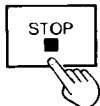

The disc will stop rotating, and the display will show the total number of tracks and the total playing time of the current disc.

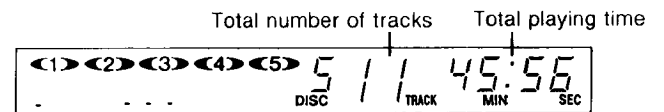

The total playing time displayed includes the silent sections between tracks. For this reason, it may be a few seconds longer than the playing time indicated on the disc.

When listening through headphones

Connect the headphones (not included) to the headphones jack.

Because the volume for the headphones cannot be adjusted on this unit, avoid listening for long periods of time if the volume of the headphones is so loud that it is uncomfortable to the ears.

Plug type: 1/4 inch phone plug, stereo type.

Direct Access Play

Direct access play involves starting play from a specific track on a specific disc and playing all discs on the five-disc tray in sequence.

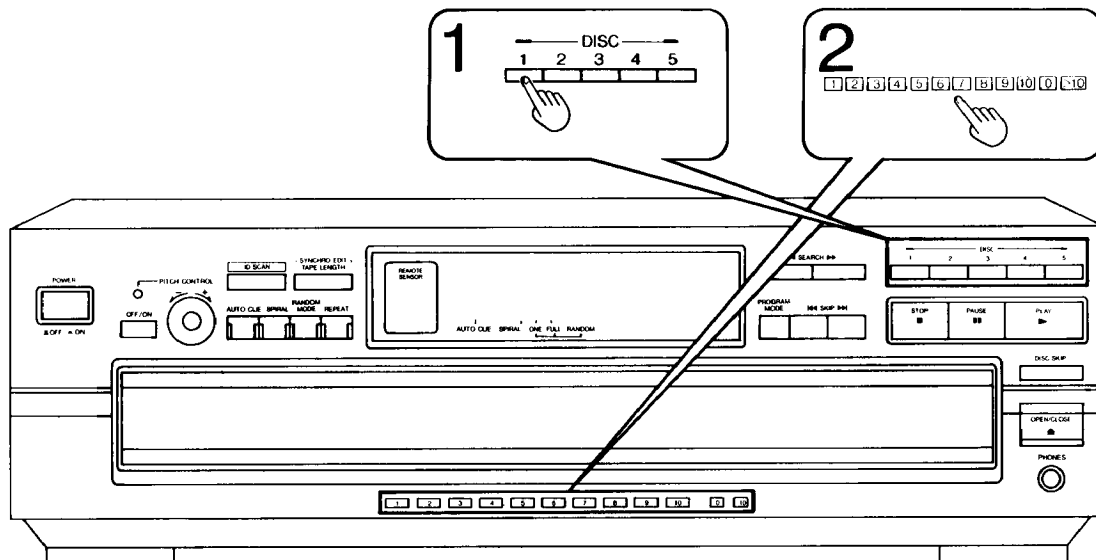

From the main unit

Before operation, follow the steps 1–4 of “Basic Operating Procedure” on page 9.

If you want to start with the disc at the playing position, proceed to step 2.

- 1 **Press the desired disc button (1–5).**
For example: To select disc 1, press the button.

The selected disc indicator will flash.

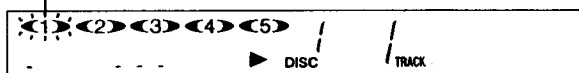

If the disc only is selected, play will begin its first track in about ten seconds.

If a disc is not on the selected disc tray, the changer plays the disc at the next number.

- 2 **Press the numeric button(s) to select the track.**



To select a track between 1 and 10:

Press the corresponding number on the keypad.

To select a two-digit track number over 10:

Press the >10 button then one of the buttons from 0–9 to select the “tens” digit. Then press one of the buttons from 0 to 9 to select the “unit” digit.

For example;

To select track number 20:

Press >10, then 2, and then 0.

Play begins at the track selected and continues through the end of the last disc.

The changer will stop automatically when the last track on the last disc finishes playing.

If you play a disc with the loading drawer open, the changer will stop when the last track on the current disc finishes playing.

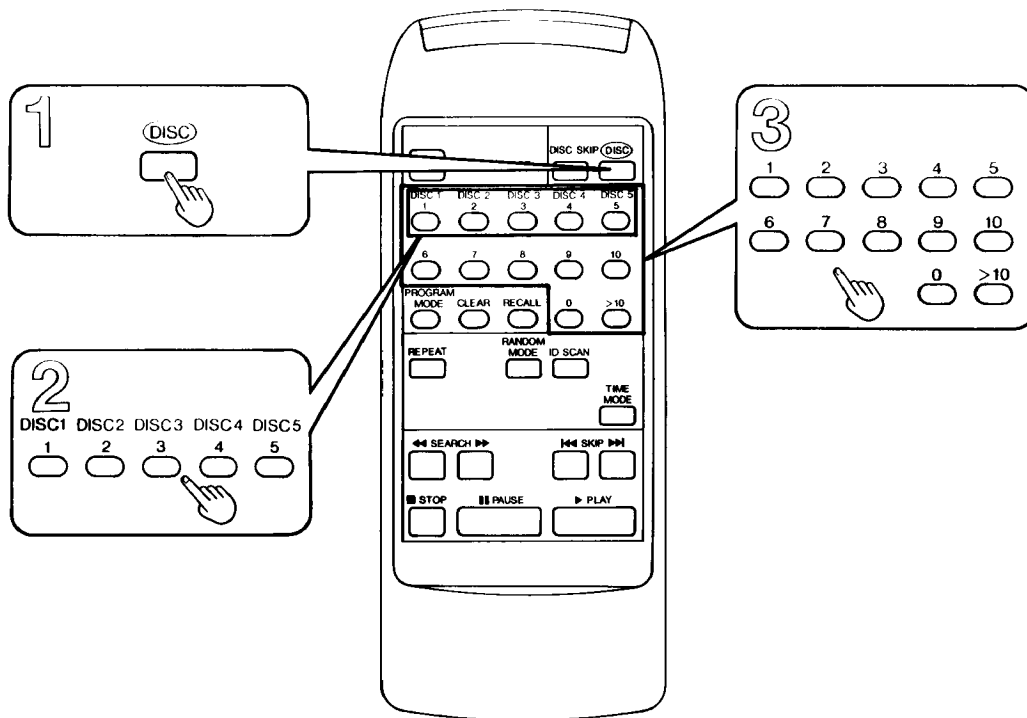

From the remote control

Before operation, follow the steps 1–4 of “Basic Operating Procedure” on page 9.

If you want to start with the disc at the playing position, proceed to step 3.

1 Press DISC.

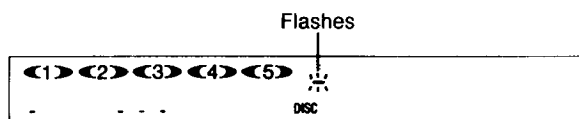

2 Press the numeric button (1–5) to select the disc.

For example: To select disc 1, press the 1 button.

The selected disc indicator will flash.

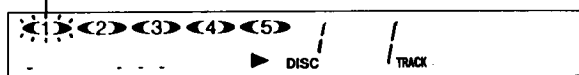

If the disc only is selected, play will begin its first track in about ten seconds.

If a disc is not on the selected disc tray, the changer plays the disc at the next number.

3 Press the numeric button(s) to select the track.



To select a track between 1 and 10:

Press the corresponding number on the keypad.

To select a two-digit track number over 10:

Press the >10 button then one of the buttons from 0–9 to select the “tens” digit. Then press one of the buttons from 0 to 9 to select the “unit” digit.

For example;

To select track number 20:

Press >10, then 2, and then 0.

Play begins at the track selected and continues through the end of the last disc.

The changer will stop automatically when the last track on the last disc finishes playing.

If you play a disc with the loading drawer open, the changer will stop when the last track on the current disc finishes playing.

Program Play

You can program up to 32 selections from the five discs in any order as you desire.

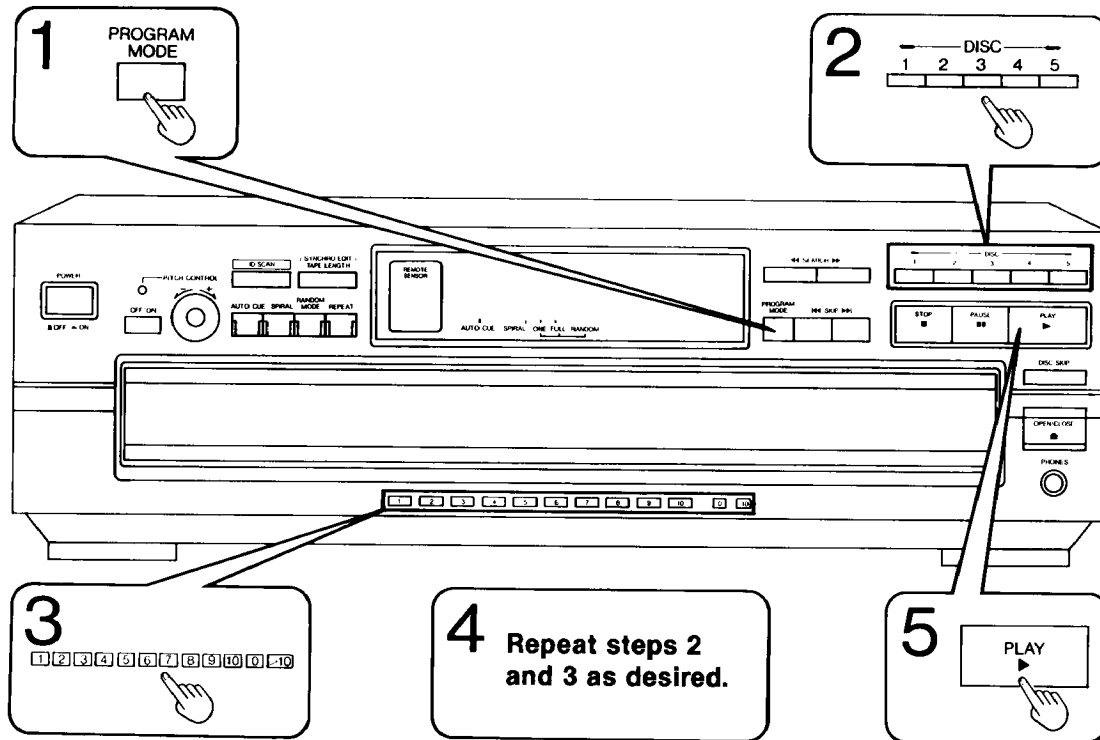

From the main unit

Before operation, follow the steps 1 – 4 of “Basic Operating Procedure” on page 9.

- 1 In the stop mode, press **PROGRAM MODE** to illuminate the program play indicator.

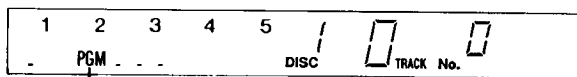

Program play indicator

- 2 Press the desired disc button (1 – 5).
For example: To select disc 3, press the **3** button.

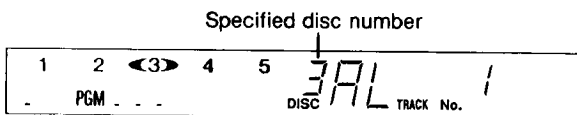

The **AL** indication shows that all the tracks on the disc are selected. Skip steps 3 and 4 if you want to enter only the disc number.

- 3 Press the numeric button(s) to specify the track number.

For example: To select track number 20, press >10, then 2, and then 0.

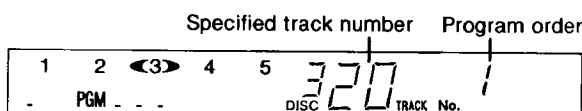

- 4 Repeat steps 2 and 3 until you have completed the desired entry.

If you enter non-existing disc(s) or track(s) soon after the loading drawer is closed or when it is open, the corresponding indicator illuminates and the entry is included in the count. In the play mode, the changer will cancel the non-existing entry and play the subsequent programmed disc or track.

If you attempt a 33rd selection, the **-F** (full) indication will be displayed.

- 5 Press **PLAY** to start play.

To enter additional selections during play, repeat steps 2 and 3.

Play the changer with the loading drawer closed.

While the loading drawer is open, if next programmed selection is in one of the other discs, the changer will stop after the current track finishes playing.

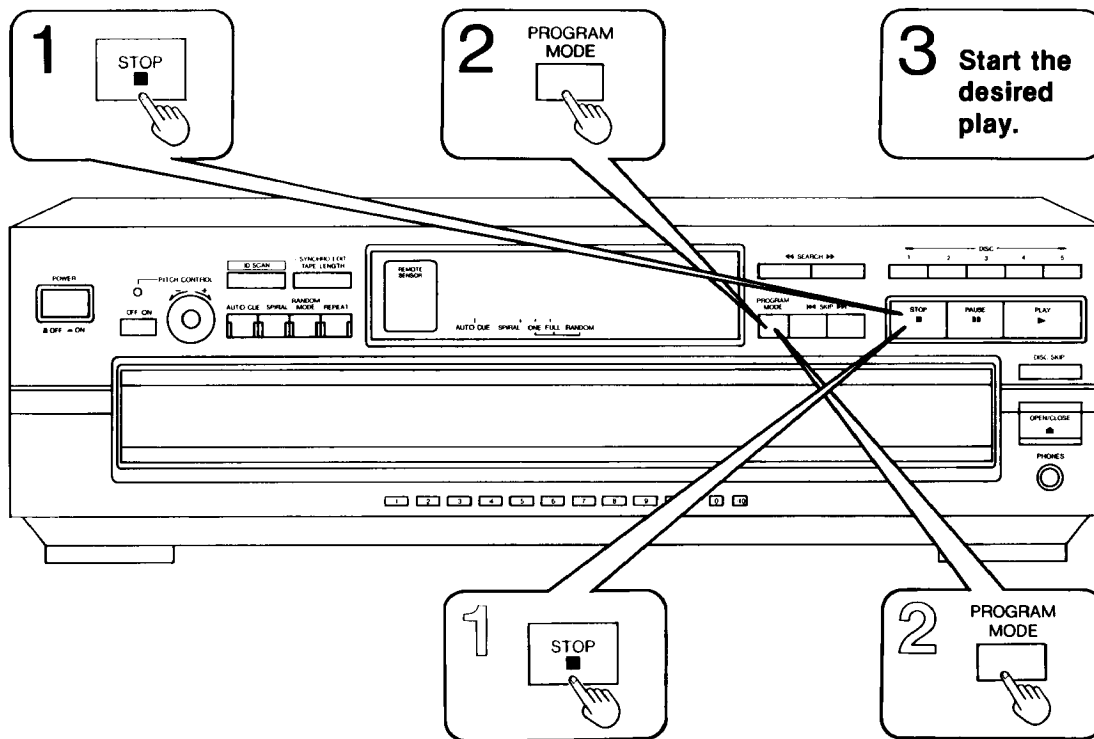

To change to the other play mode keeping the programmed contents (Also available from the remote control.)

1 Press **STOP** during play.

2 Press **PROGRAM MODE** twice.

The changer switches to sequential mode.

The program mode will be canceled but the changer still has the programmed contents in its memory.

3 Start the desired play (except delete play).

To resume program mode, press PROGRAM MODE in the stop mode to illuminate the program indicator.

To clear the entire programmed contents without canceling program mode (Also available from the remote control.)

Press STOP in the program mode.

Press once in the stop mode or twice during play.



This clears all programmed contents from memory.

The display will indicate as below.

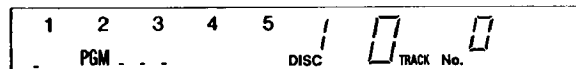

To cancel program mode (Also available from the remote control.)

In this case, all programmed contents will also be cleared from memory.

1 Press **STOP** in the program mode.

Press once in the stop mode or twice during play.

The display will indicate as below.

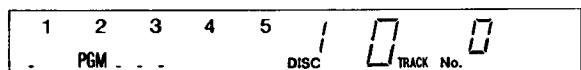

2 Press **PROGRAM MODE** twice.

The changer switches to sequential mode.

Turning off the power will also cancel program mode.

Program Play (continued)

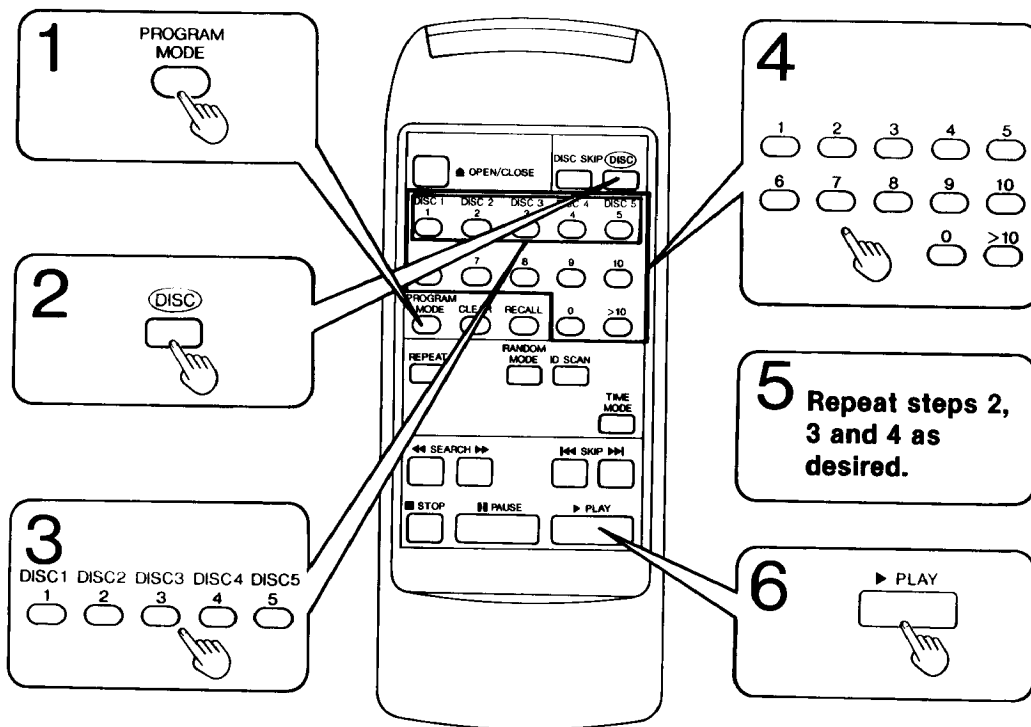

From the remote control

Before operation, follow the steps 1 – 4 of “Basic Operating Procedure” on page 9.

- 1 In the stop mode, press PROGRAM MODE to illuminate the program play indicator.**
Skip to step 4 if the disc number display shows the desired disc number.

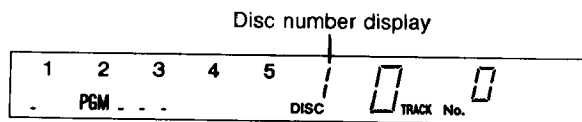

- 2 Press DISC.**
- 3 Press the numeric button (1–5) to specify the disc number.**
Skip to step 5 if you want to enter only the disc number.
- 4 Press the numeric button(s) to specify the track number.**
For example: To select track number 20, press >10, then 2, and then 0.

- 5 Repeat steps 2, 3 and 4 until you have completed the desired entry.**

If you enter non-existing disc(s) or track(s) soon after the loading drawer is closed or when it is open, the corresponding indicator illuminates and the entry is included in the count. In the play mode, the changer will cancel the non-existing entry and play the subsequent programmed disc or track.

If you attempt a 33rd selection, the $-F$ (full) indication will be displayed.

- 6 Press PLAY to start play.**
To enter additional selections during play, repeat steps 2, 3 and 4.

Play the changer with the loading drawer closed. While the loading drawer is open, if next programmed selection is in one of the other discs, the changer will stop after the current track finishes playing.

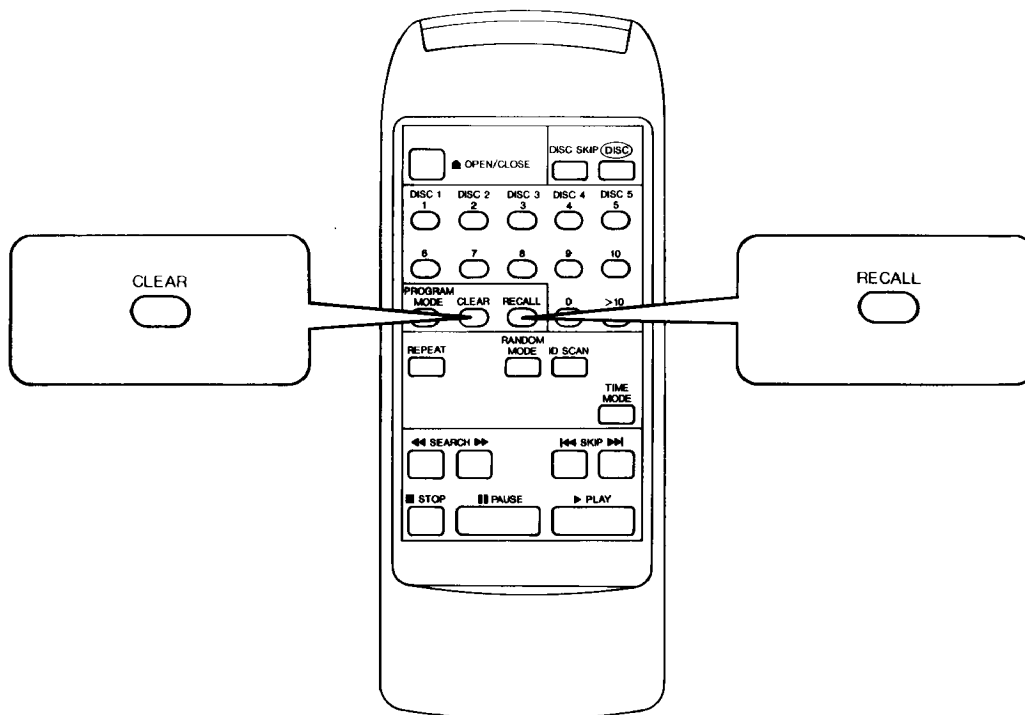

To confirm the program

Press **RECALL**.



Each time you press RECALL, the display shows the programmed disc and track number in the sequence you have entered.

For example, the diagram on the right shows a program consisting of tracks 3, 5 and 1 on disc 3.

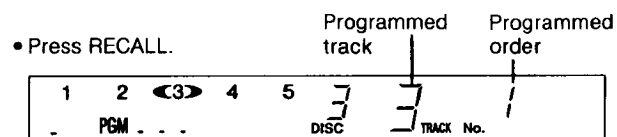

• Press RECALL again.

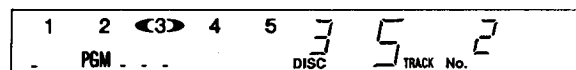

• Press RECALL again.

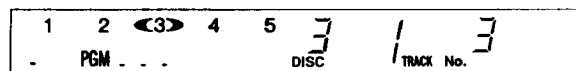

To clear a program entry

Press **CLEAR**.



Each time you press CLEAR, you will cancel last entry in the order you have entered.

To clear an entry in the middle of the program sequence, press RECALL repeatedly until the display shows the selection to be cleared; then press CLEAR.

Delete Play

You can select up to 32 selections that you do not want to hear and put them in the changer's memory. Then you can enjoy sequential, one disc random, or full random play of only your favorite tracks.

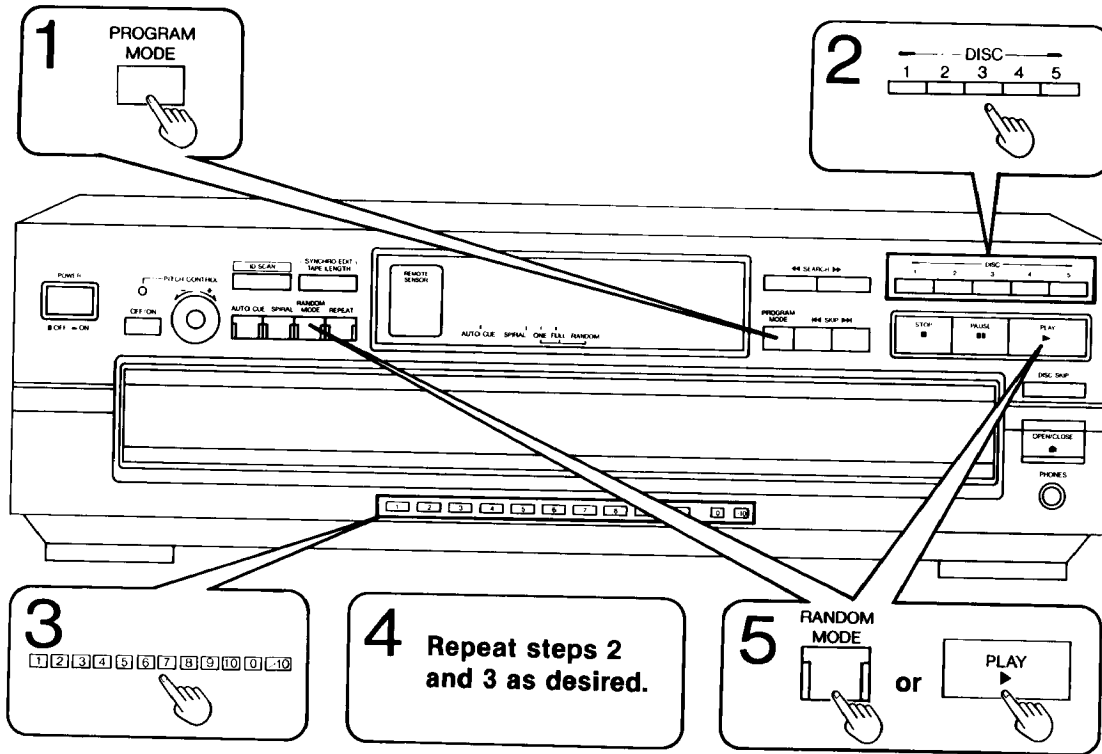

From the main unit

Before operation, follow the steps 1–4 of “Basic Operating Procedure” on page 9.

- 1 In the stop mode, press **PROGRAM MODE** to illuminate the delete play indicator.

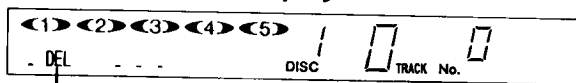

Delete play indicator

- 2 Press the **disc button (1–5)**.
For example: To delete disc 3, press the **3** button.
Specified disc number

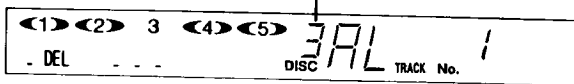

The **AL** indication shows that all the tracks on the disc are selected. Skip steps 3 and 4 if you want to delete all the tracks on the disc.

- 3 Press the **numeric button(s)** to specify the track number.

For example: To select track number 20, press >10, then 2, and then 0.

Specified track number Order you have entered

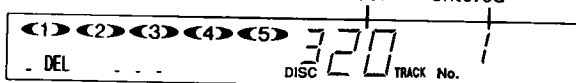

- 4 Repeat steps 2 and 3 until you have completed the desired entry.

If you enter non-existing disc(s) or track(s) soon after the loading drawer is closed or when it is open, the corresponding indicator illuminates and the entry is included in the count. In the play mode, the changer will cancel the non-existing entry.

If you attempt a 33rd selection, the **-F** (full) indication will be displayed.

- 5 Press to start play.

To activate sequential play, press **PLAY**.

To activate one disc random play, press **RANDOM MODE**.

To activate full random play, press **RANDOM MODE** twice.

To enter additional selections to be deleted during play, repeat steps 2 and 3.

If you play a disc with the loading drawer open, the changer will stop when the last track on the current disc finishes playing.

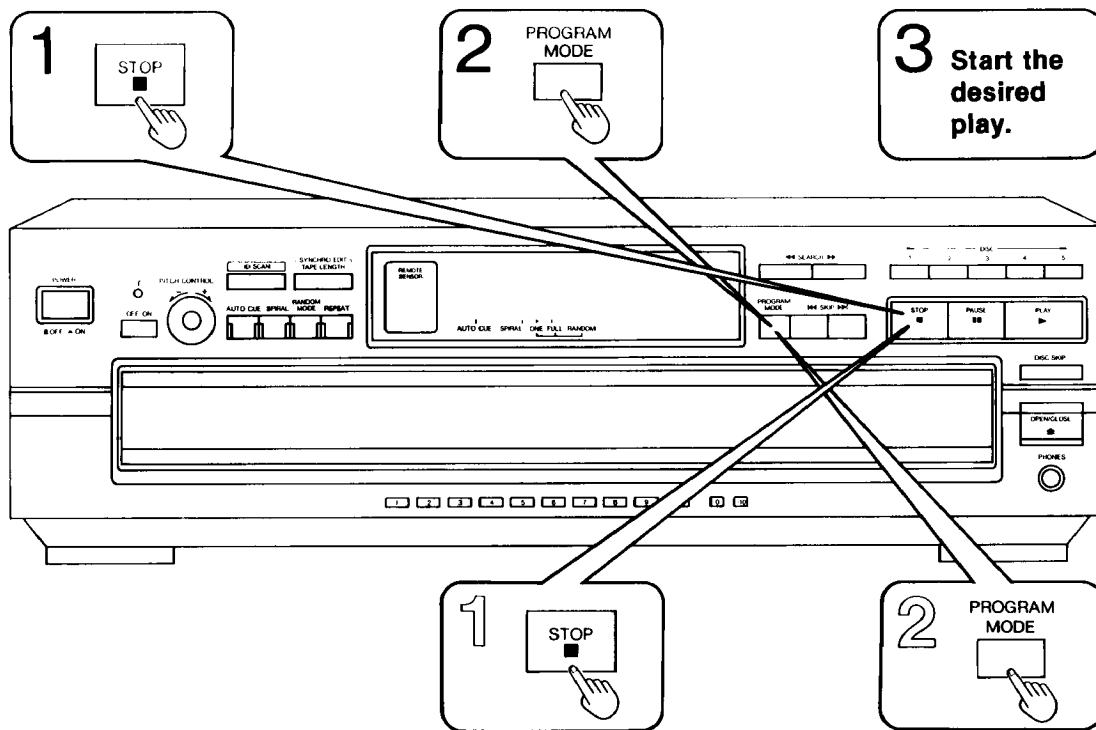

To change to the other play mode keeping the contents to be deleted (Also available from the remote control.)

- 1 Press **STOP** during play.
- 2 Press **PROGRAM MODE**.
The changer switches to sequential mode.
The delete mode will be canceled but the changer still has the contents to be deleted in its memory.
- 3 Start the desired play (except program play).
To resume delete mode, press **PROGRAM MODE** twice in the stop mode to illuminate the delete indicator.

To clear the entire contents to be deleted without canceling delete mode (Also available from the remote control.)

Press **STOP** in the delete mode.

Press once in the stop mode or twice during play.

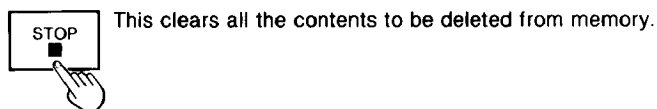

The display will indicate as below.

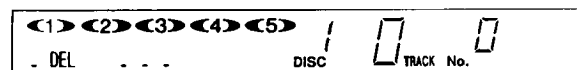

To cancel delete mode (Also available from the remote control.)

In this case, all the contents to be deleted will also be cleared from memory.

- 1 Press **STOP** in the delete mode.
Press once in the stop mode or twice during play.
The display will indicate as below.
- 2 Press **PROGRAM MODE**.
The changer switches to sequential mode.
Turning off the power will also cancel delete mode.



Delete Play (continued)

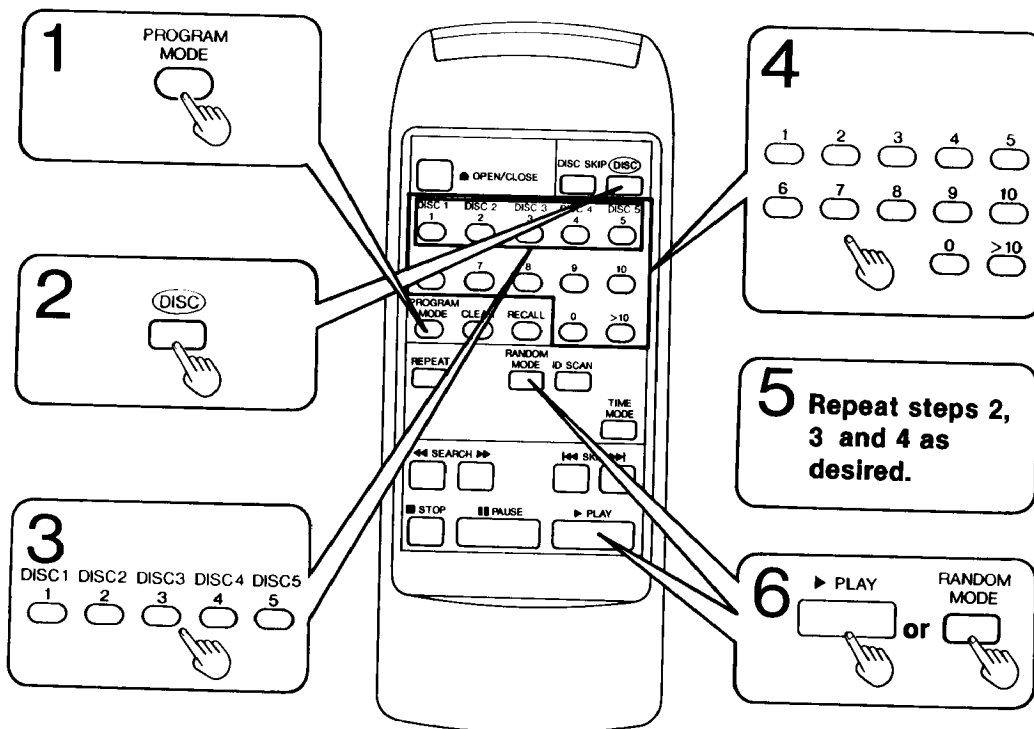

From the remote control

Before operation, follow the steps 1 – 4 of “Basic Operating Procedure” on page 9.

- 1 In the stop mode, press PROGRAM MODE to illuminate the delete play indicator.**

Skip to step 4 if the disc number display shows the disc number you want to delete.

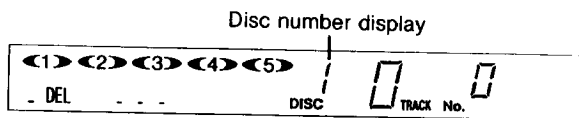

- 2 Press DISC.**
- 3 Press the numeric button (1 – 5) to specify the disc number.**
Skip to step 5 if you want to enter only the disc number.
- 4 Press the numeric button(s) to specify the track number.**

For example: To select track number 20, press >10, then 2, and then 0.

- 5 Repeat steps 2, 3 and 4 until you have completed the desired entry.**

If you enter non-existing disc(s) or track(s) soon after the loading drawer is closed or when it is open, the corresponding indicator illuminates and the entry is included in the count. In the play mode, the changer will cancel the non-existing entry.

If you attempt a 33rd selection, the $-F$ (full) indication will be displayed.

- 6 Press to start play.**

To activate sequential play, press PLAY.
To activate random play, press RANDOM.

To enter additional selections to be deleted during play, repeat steps 2, 3 and 4.

If you play a disc with the loading drawer open, the changer will stop when the last track on the current disc finishes playing.

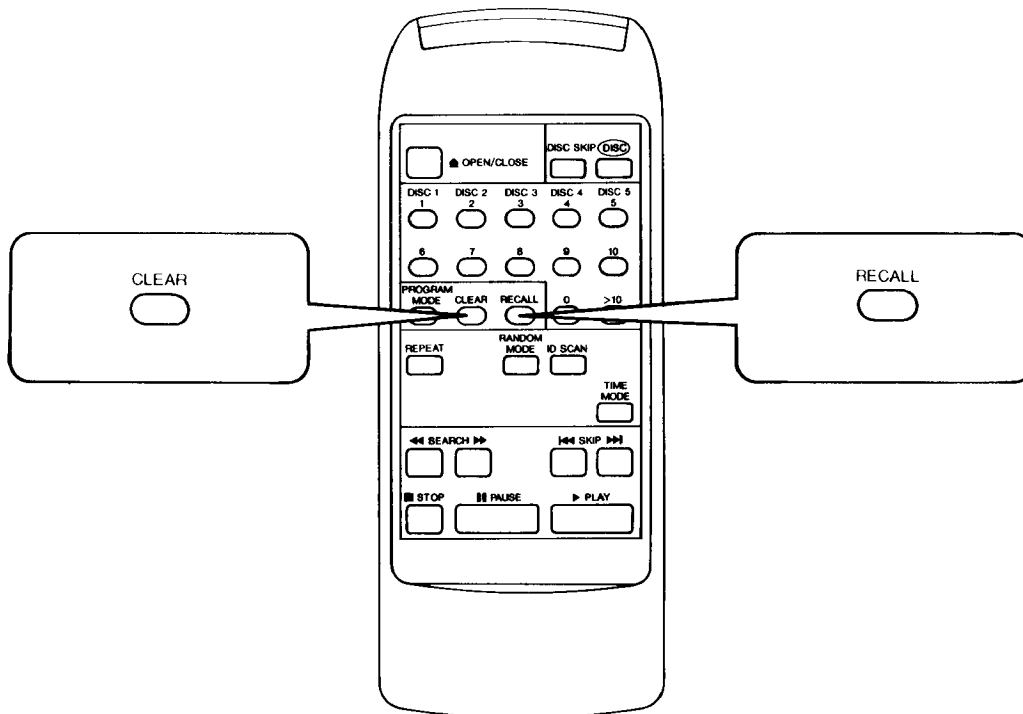

To confirm the selections to be deleted

Press **RECALL**.



Each time you press RECALL, the display shows the selected disc and track number in the sequence you have entered.
For example, the diagram on the right shows the contents when you have entered track 3, 5 then 1 on disc 3.

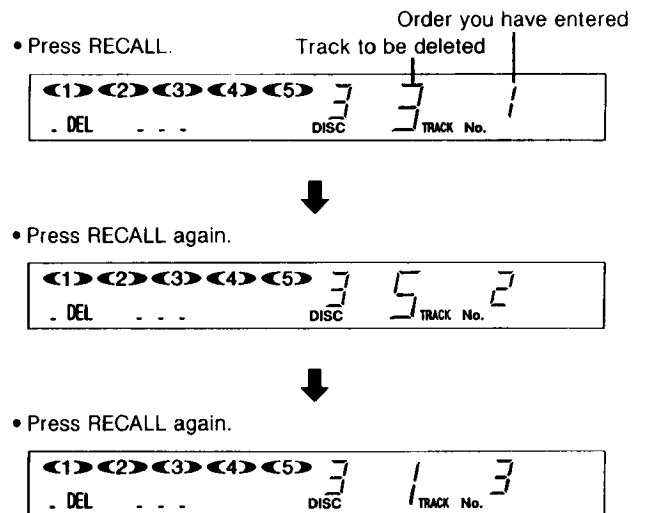

To clear a selection to be deleted

Press **CLEAR**.



Each time you press CLEAR, you will cancel last entry in the order you have entered.

To clear a selection in the middle of the sequence, press RECALL repeatedly until the display shows the selection to be cleared; then press CLEAR.

Random Play

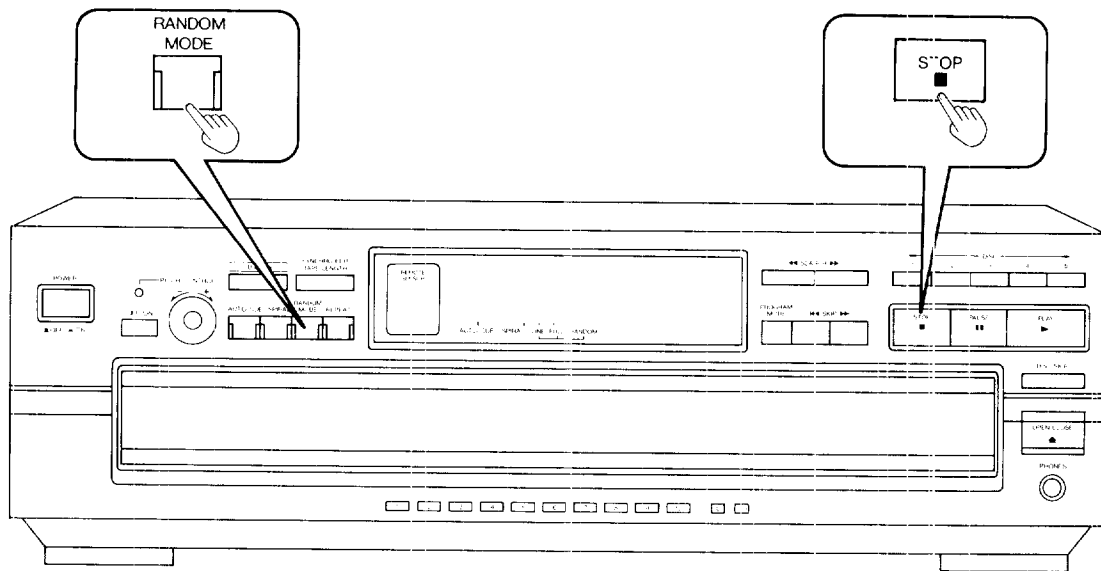

One disc random play (Also available from the remote control.)

The changer will play all tracks on the current disc in a random order. Then it will choose a new disc randomly, excluding the discs already played, and play all tracks in a random order.

Before operation, follow the steps 1 – 4 of “Basic Operating Procedure” on page 9.

Press RANDOM MODE so that the play mode indicator points to ONE.

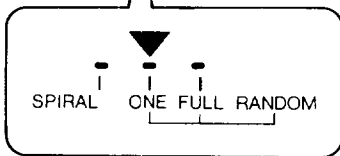
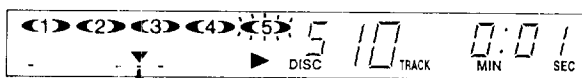
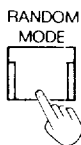

In delete play mode, the changer will choose a disc and track excluding the selections to be deleted.

The changer will stop automatically when all the tracks on all discs have played once.

Play the changer with the loading drawer closed. While the loading drawer is open, the changer will stop after the current disc finishes playing.

To cancel one disc random play mode

Press STOP.

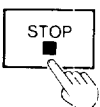

The ONE play mode indicator will go out. The changer will change to stop mode.

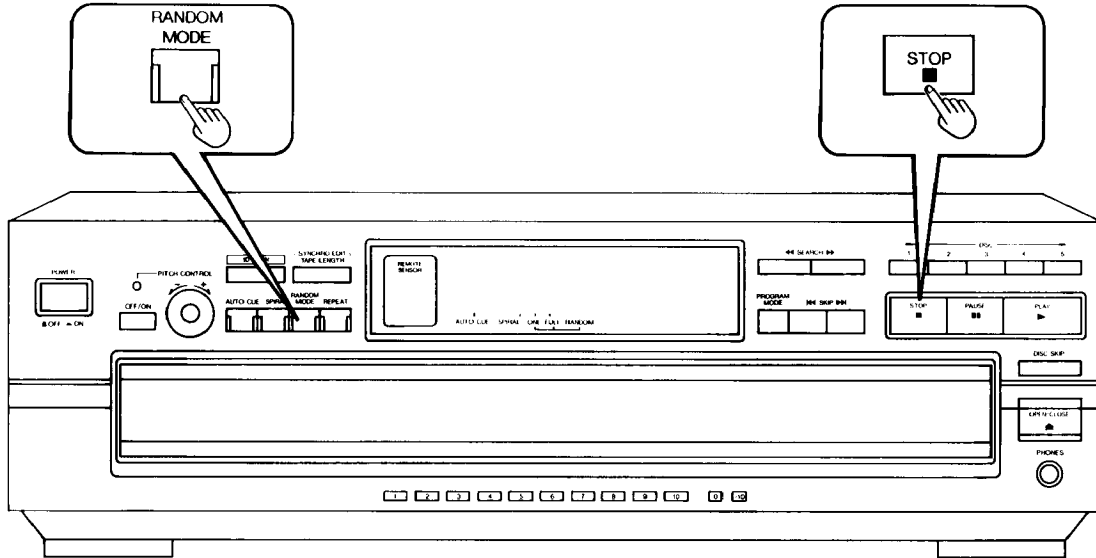

Full random play (Also available from the remote control.)

The changer will randomly choose a track within a randomly selected disc. Once the changer has played the selected track, it will choose a disc then a track randomly again, excluding the tracks already played.

Before operation, follow the steps 1–4 of “Basic Operating Procedure” on page 9.

Press RANDOM MODE so that the play mode indicator points to FULL.

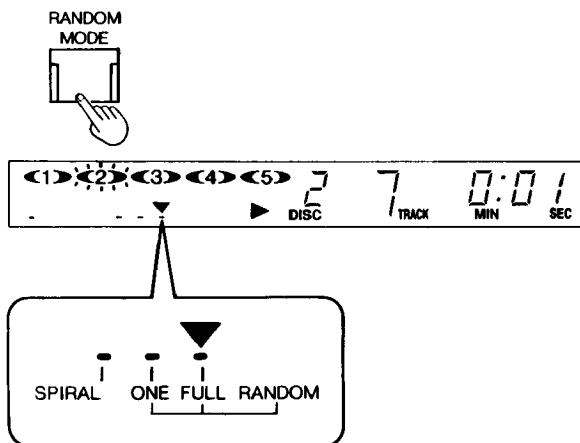

In delete play mode, the changer will choose a disc and track excluding the selections to be deleted.

The changer will stop automatically when all the tracks on all discs have played once.

Play the changer with the loading drawer closed. While the loading drawer is open, if next track is in one of the other discs, the changer will stop after the current track finishes playing.

To cancel full random play mode

Press STOP.

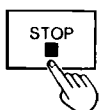

The FULL play mode indicator will go out. The changer will change to stop mode.

Spiral Play

The changer plays the first tracks on all the loaded discs in sequence, followed by the second tracks on all the discs, and so on.

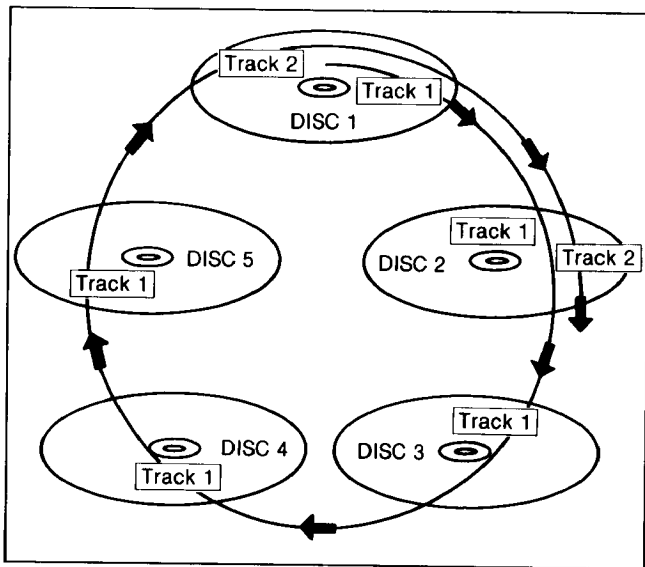
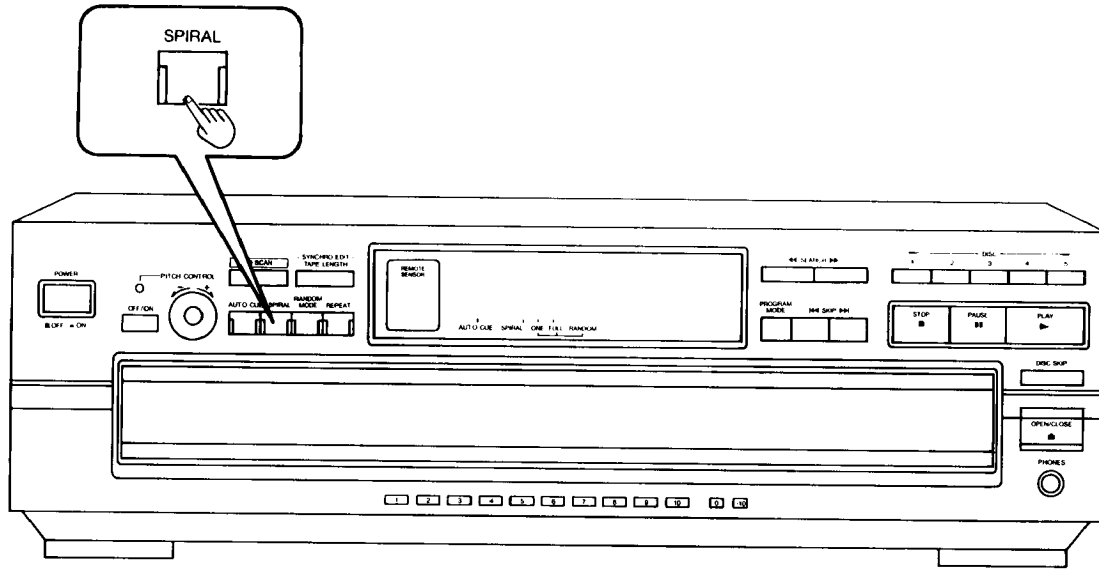

Before operation, follow the steps 1 – 4 of “Basic Operating Procedure” on page 9.

Press SPIRAL.



The play mode indicator points to SPIRAL and spiral play will begin with the first track on the disc at the playing position.

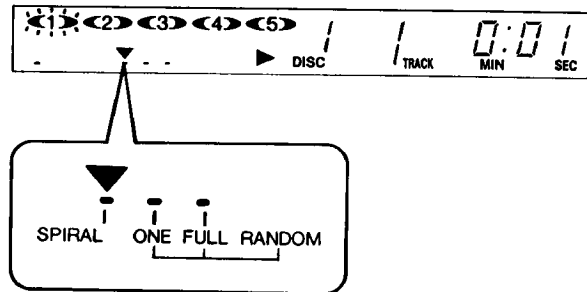

When the disc with less number of tracks finishes playing, that disc will be skipped and the changer will continue playing with the other discs having the tracks not played yet.

The changer will stop automatically when all the tracks on all discs have played once.

Play the changer with the loading drawer closed. While the loading drawer is open, the changer will stop after the current track finishes playing.

To cancel spiral play mode

Press SPIRAL again.



The SPIRAL play mode indicator will go out. The changer will return to sequential play mode from the current track on the current disc which is playing.

Special Features

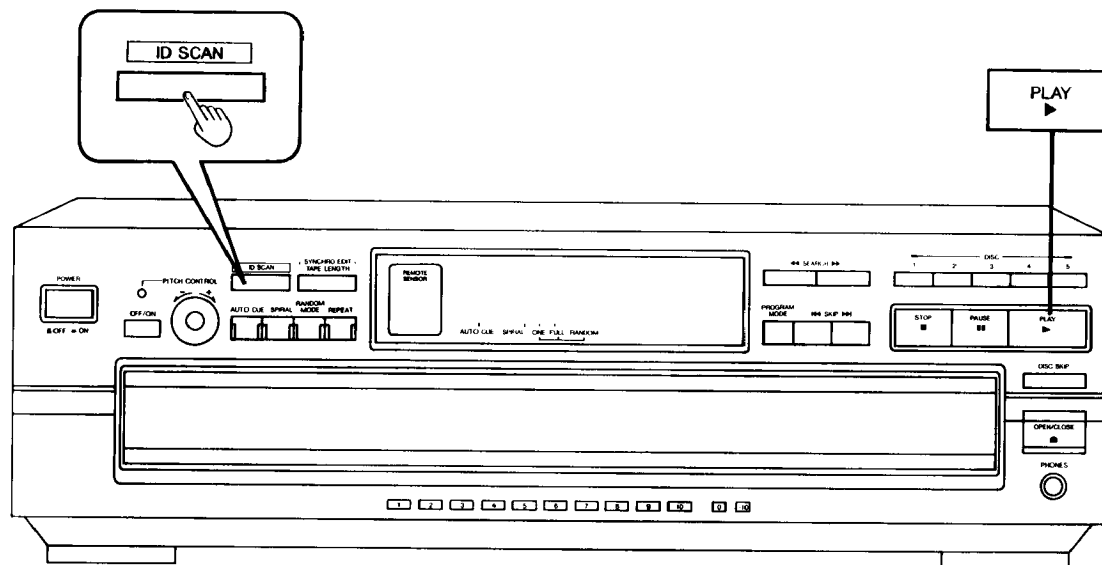

ID scan function (Also available from the remote control.)

This function is convenient when searching for a desired track. The function will search from the beginning of the track for a loud section, and will play 10 seconds of the track centering around that point. The order of scanning is the same as for playback mode.

Press ID SCAN.

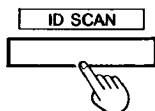

The ID scan indicator will illuminate and ID scan function will operate.

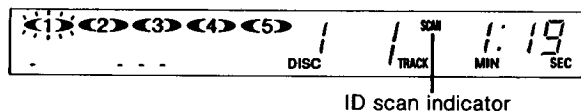

When the desired track has been found:

Press PLAY.

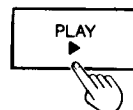

The track will then be played back from the beginning.

To cancel ID scan

Press ID SCAN while this function is in operation.

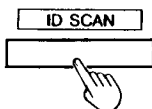

The ID scan indicator will go out. The changer will continue to play from the current track on the current disc which has been playing.

Special Features (continued)

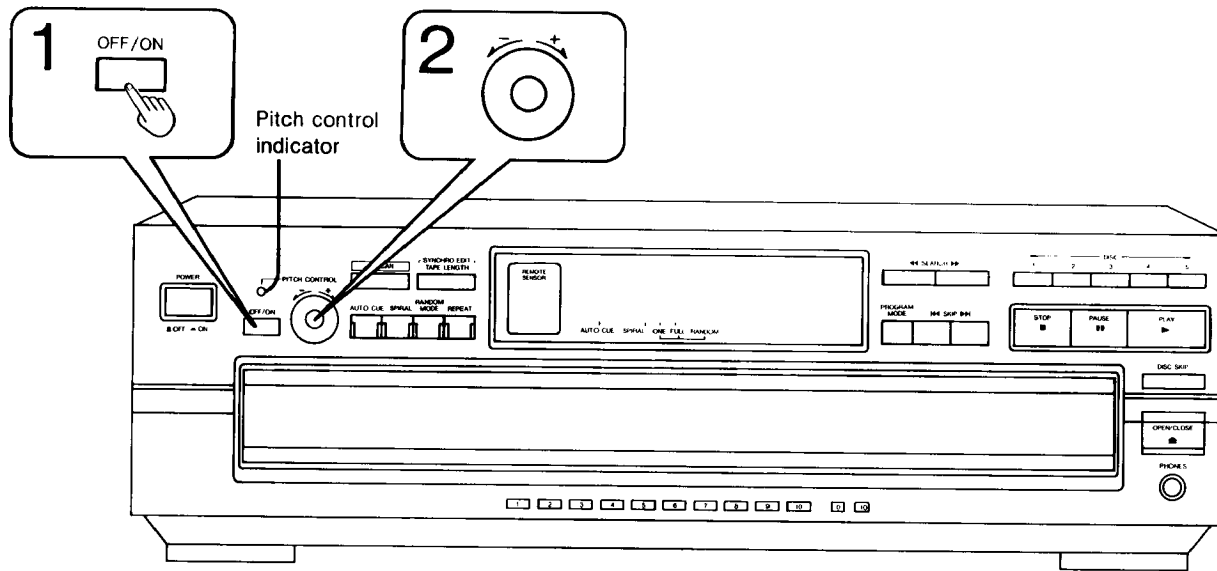

Pitch control function

The playback pitch can be changed as desired within a range of $\pm 12.5\%$. (The tempo and the pitch of the sound will change simultaneously.)

1 Press OFF/ON

The pitch control indicator will illuminate.

2 Turn the knob in the “+” or “-” direction.

The pitch will change while the knob is being held, and the changed values will show on the display.

- + : Pitch increases
- : Pitch decreases

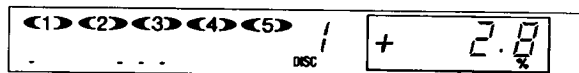

Pitch display

If the knob is released, the pitch will stop changing, and after approximately 2 seconds the pitch display will change back to the time display.

Pitch changing steps

The +5.9% position is a half tone sharp (♯).
The -5.6% position is a half tone flat (♭).

The pitch can be adjusted by turning the knob even if the pitch control indicator is switched off. The playback sound will not change if this is done. To play back at the setting pitch, press OFF/ON to make the pitch control indicator illuminate.

Fine adjustment is possible by turning the knob and then immediately turning it back to the original position. In this case, the pitch will change by 0.1% only.

While changing the pitch, the time display will show the playback position only. This will not match the actual playback time.

To play in the 0% standard pitch

Press OFF/ON to switch off the pitch control indicator.

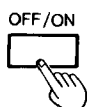

Even after the pitch control indicator has been switched off, the pitch setting will remain in memory as long as the power of the changer is not turned off.

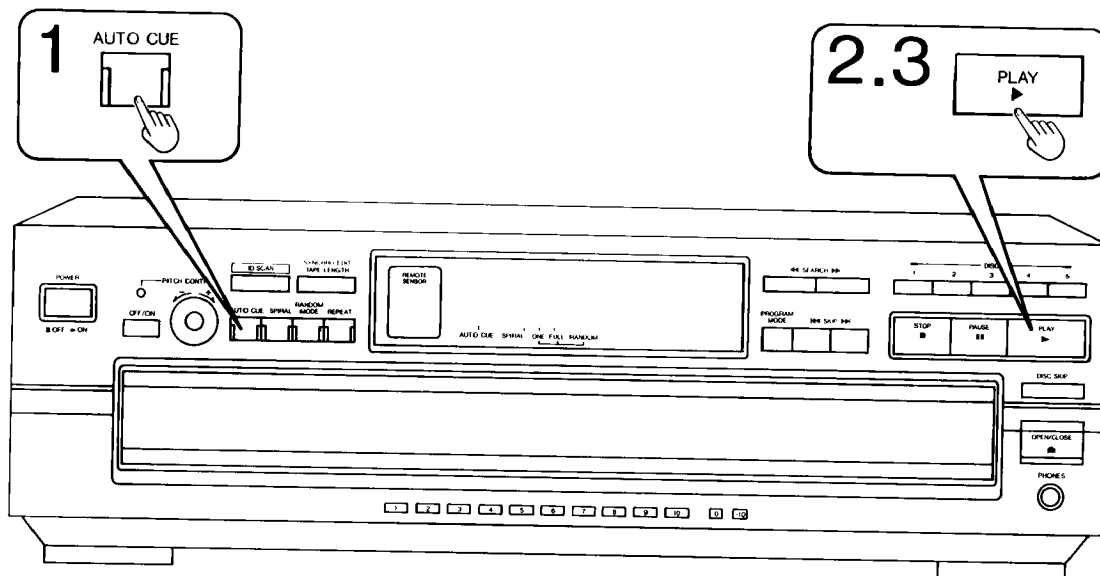

Auto cue function

The auto cue function allows the unit to wait in a standby condition at the beginning of each track so as to start play right when you are ready.

When each track finishes playing, the unit skips to the beginning of the next track and switches to the play standby mode.

1 Press AUTO CUE.

The auto cue indicator will illuminate.

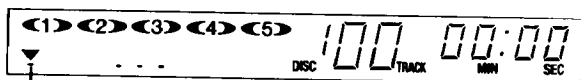

Auto cue indicator

2 Press PLAY.

(Also available from the remote control.)

The changer switches to the play standby mode at the beginning of the track.

The pause indicator will illuminate, and the play indicator will flash.

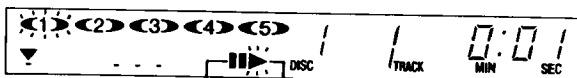

Pause indicator Play indicator

3 Press PLAY again to start play. (Also available from the remote control.)

Press PLAY at the beginning of each track.

The auto cue function may not cause the unit to wait exactly at the beginning of a track if the track begins with a very soft passage or if there is a lot of background noise.

To cancel auto cue

Press AUTO CUE.



The auto cue indicator will go out.

Special Features (continued)

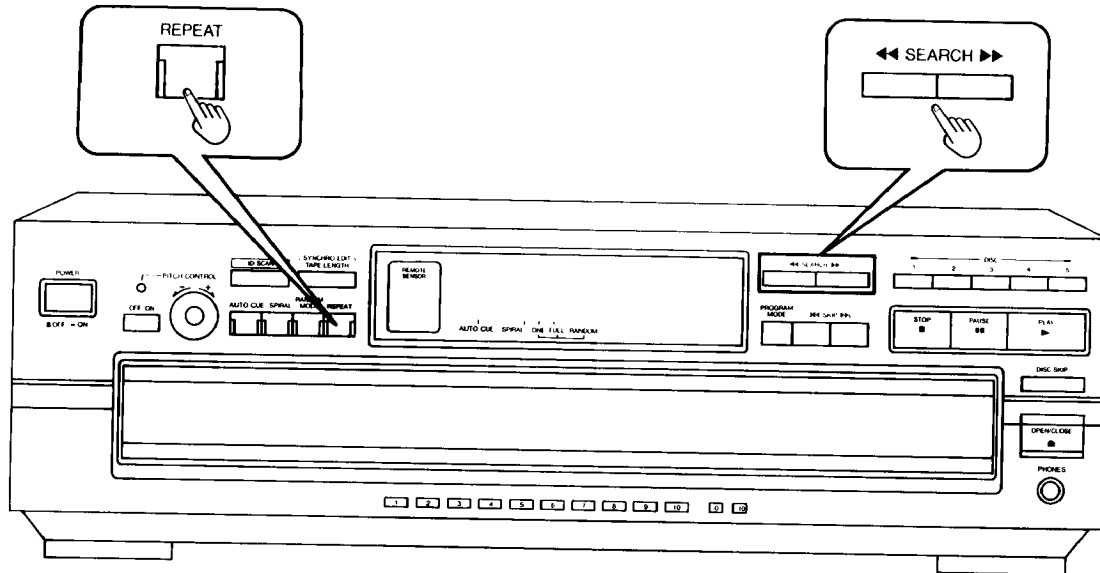

Repeat function (Also available from the remote control.)

You can use this function in all play modes.

Press REPEAT before or during play.

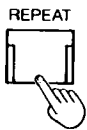

The repeat indicator will illuminate.

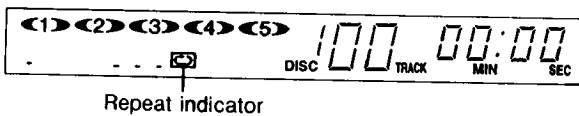

Repeat indicator

In sequential play mode:

All tracks of all discs will be played repeatedly.

In program play mode:

The changer plays only the programmed selections in the programmed sequence repeatedly.

In delete play mode:

The changer plays the discs and tracks excluding the selections to be deleted repeatedly.

In random play mode:

When the changer has played all the tracks on all the loaded discs, it will select a new random sequence and play continuously. The sequence differs each time.

In spiral play mode:

The changer plays all tracks of all discs repeatedly in the sequence of spiral play.

To cancel repeat function

Press REPEAT again.

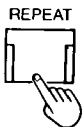

The repeat indicator will go out.

Search function (Also available from the remote control.)

You can search rapidly forward or backward on the disc for specific sections.

In the play or pause mode, press and hold ◀◀ or ▶▶.

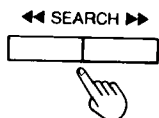

▶▶ : You can search forward.
◀◀ : You can search backward.

Release the button when you reach desired point.

The changer moves slowly at first and then rapidly if the button is held down for more than about three seconds.

In the play mode, the sound level decreases by 12 dB (1/4).

In the pause mode, no sound is heard. It remains at the point where ◀◀ or ▶▶ is released.

In sequential play mode:

You can search forward over discs and backward within the current disc.

In other play modes:

You can search forward or backward only within the current track.

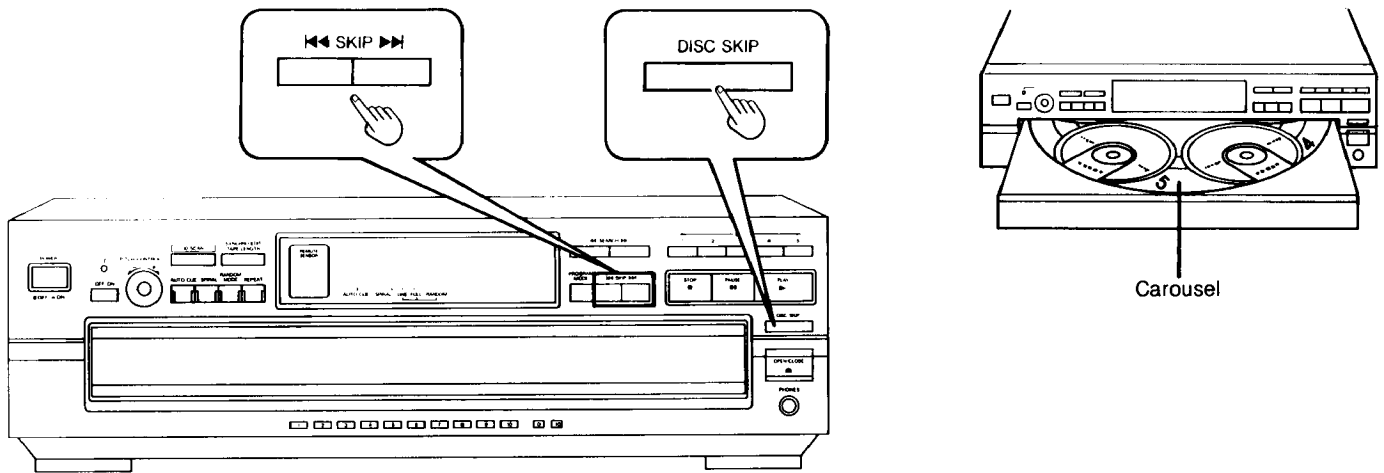

Skip function (Also available from the remote control.)

To skip discs

You can use this function in stop mode, sequential play, one disc random play and delete play mode.

Press DISC SKIP to rotate the disc tray.

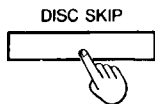

Disc number at the playing position

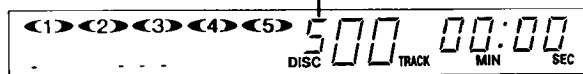

In stop mode:

When the loading drawer is closed, pressing DISC SKIP changes the disc tray to the next one.

When the loading drawer is open, pressing DISC SKIP moves the carousel by two disc trays.

In play mode:

When the loading drawer is closed, pressing DISC SKIP changes the disc and the changer plays the track on next disc.

When the loading drawer is open, pressing DISC SKIP moves the disc tray to the next one. Pressing again moves the carousel in the opposite direction so that you can change all discs except the one being played.

To skip tracks

Press either SKIP (◀◀ or ▶▶) until you reach the desired track.

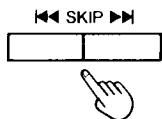

▶▶: You can skip forward.
◀◀: You can skip backward.

In sequential/program/delete play mode:

In sequential play mode, you can skip only within the current disc. In program play mode, you can skip from one track to another in the programmed sequence.

In delete play mode, you can skip tracks only within the current disc excluding the tracks to be deleted.

▶▶: You can skip as many tracks as the number of times you press the button.

◀◀: You can skip to the beginning of the track being played. If you press this button again quickly, you can skip to the beginning of the previous track.

Remember that in a backward skip, the current track is included in the count.

In random play mode:

▶▶: You can skip to the beginning of a next track in random manner.

◀◀: You can skip to the beginning of the current track.

In spiral play mode:

▶▶: You can skip to the beginning of a track on next disc.

◀◀: You can skip to the beginning of a current track.

You can also skip tracks when the changer is in the pause mode or stop mode.

Special Features (continued)

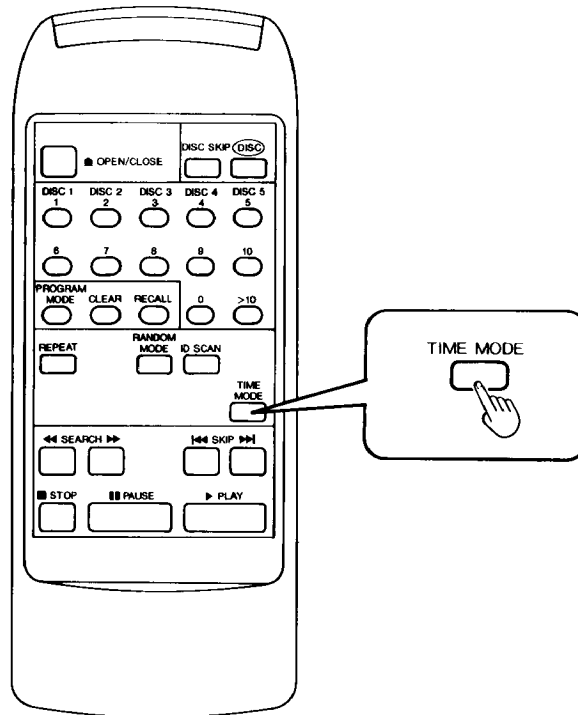

Time mode selection (Only available from the remote control.)

Press **TIME MODE** in the play or pause mode.

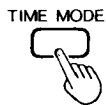

The information will change (as described below) each time you press the button.

1 Track number and elapsed play time of the current track.

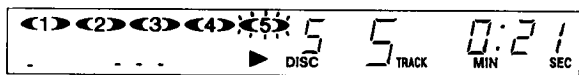

2 Total remaining time on the disc.

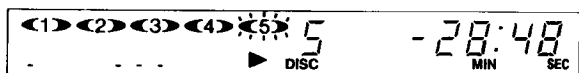

3 Track number and remaining time of the current track.

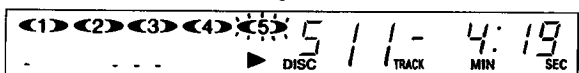

4 Total elapsed play time on the disc.

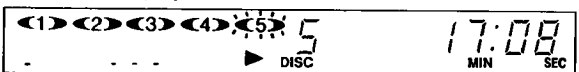

In all play modes:

When track number 21 or greater is playing, display 3 shows "----".

In program/delete/random/spiral mode:

The displayed information will alternate between displays 1 and 3 each time the button is pressed.

In CD edit-recording mode:

The remaining play time on side A or side B will be shown in display 2, and the elapsed play time for side A or side B will be shown in display 4.

When you stop playing and play again, the display will return to display 1.

CD Edit-Recording

Noted below are two methods for recording so that the tracks are divided between Side A and B according to the length of the tape, and the track is not cut off in the middle by the end of the tape. Select the desired method and record.

About sequential-edit-recording

A method recording sequentially beginning with the first track by selecting the disc (1 disc) you want to record from the discs set in the changer.

When the length of the tape for recording is designated, the microcomputer in the changer automatically calculates which tracks will be entered onto sides A and B, and displays this in the display. When recording of side A finishes, the reverse function of the cassette deck operates and recording on side B begins. Then, after the last track to be entered onto side B finishes playing, the changer stops and the cassette deck returns to a paused condition.

(See pages 32–33.)

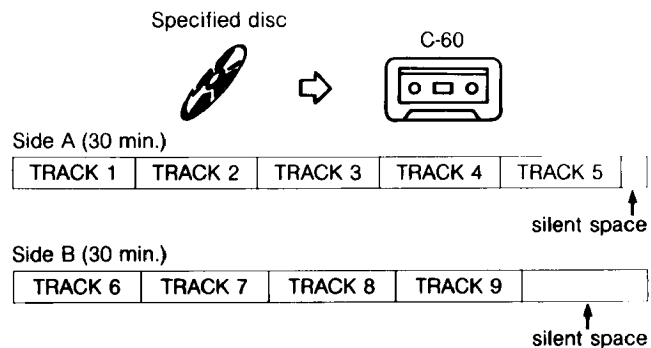

About program-edit-recording

A method for programming and recording the tracks you desire from among the discs set in the changer (maximum of 5 discs). When recording of side A finishes, the reverse function of the cassette deck operates and side B automatically begins recording. Then, when the next track to be recorded will not fit in the time remaining, the changer stops and the cassette deck returns to a paused condition.

(See page 34.)

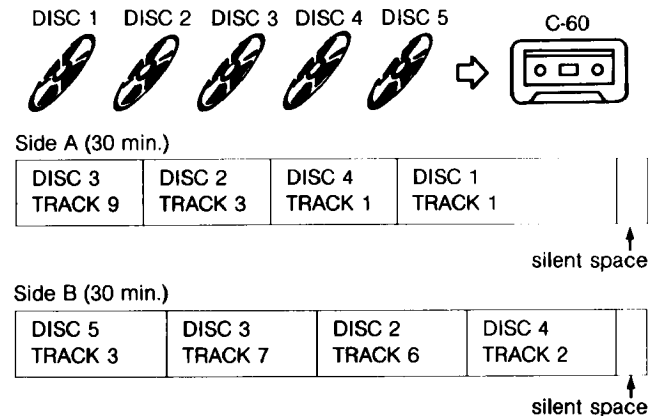

CD Edit-Recording (continued)

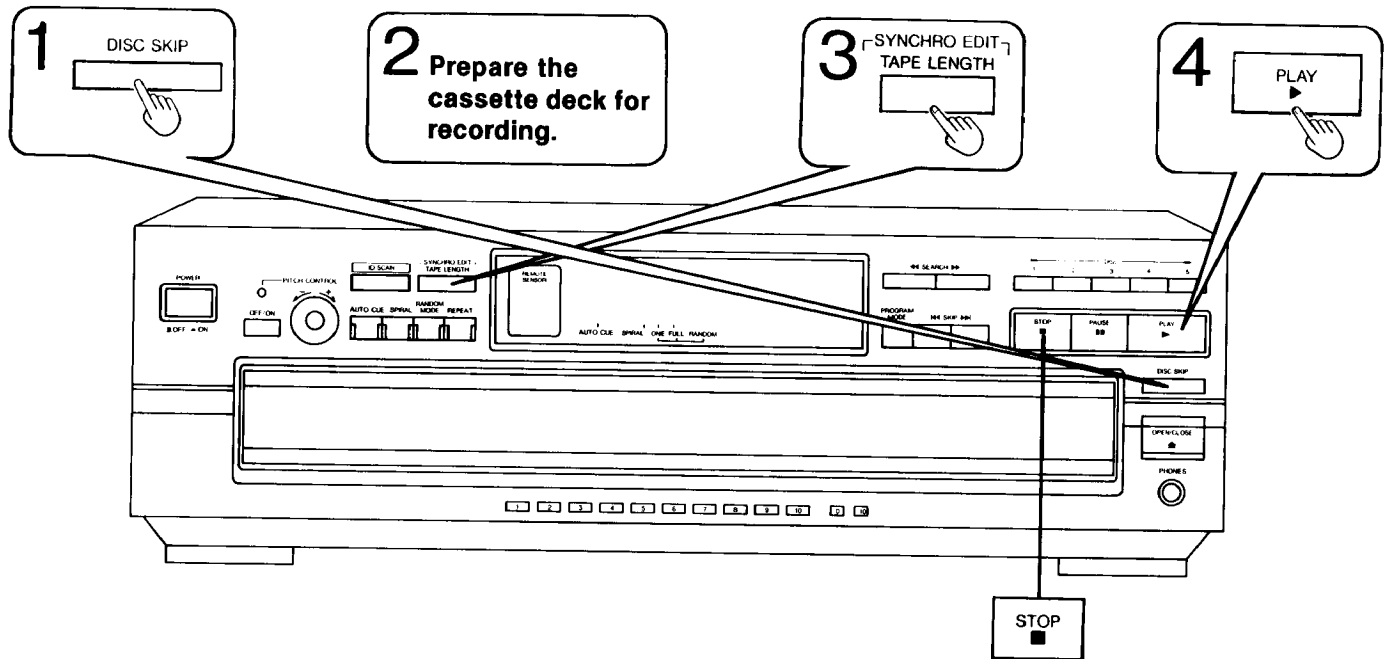

Sequential-edit-recording

The changer automatically calculates how many tracks on the specified disc will fit on a given tape side and programs them for you.

Before operation, follow the steps 1–4 of “Basic Operating Procedure” on page 9.

- 1 Press DISC SKIP to select the disc to be recorded.

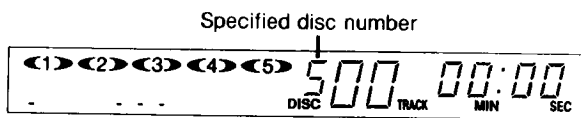

- 2 Prepare the cassette deck for recording.

1. Insert the cassette tape into the cassette holder of the deck for the synchro edit recording. (Be sure the tape is re-wound.)
 2. Select the noise-reduction system and the reverse mode (↺).
 3. Check to be sure that the forward-side indicator (▶) of the deck to be used is illuminated.
 4. Press PLAY of this changer.
 5. Set the cassette deck on the recording standby mode.
 6. Adjust the recording level.
 7. Press STOP of this changer.
- (Refer to the operating instructions for the cassette deck.)

- 3 Press TAPE LENGTH to select the tape length.

Each time you press the button, the display showing the tape length changes as follows. Choose the length of the tape you will use.

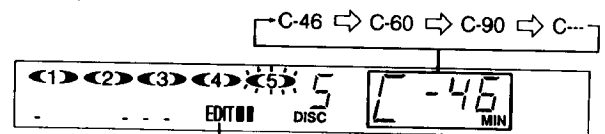

Compact disc edit indicator

The maximum allowable playing time for editing is 99 minutes.

To enter desired recording time other than 46, 60 or 90 minutes:

- 1 Select C---
- 2 Enter the total recording time in minutes (1-99) using the numeric buttons on the remote control.

For example:

To use 52-minute tape, press 5 then 2.

You can also specify the tape length pressing the skip button. Press either ▶▶ or ◀◀ from each step C-46, C-60, C-90 or C---

For example:

To use 52-minute tape, select C-46 and press and hold ▶▶ until the display shows 52.

The display shows the data of the tracks to be recorded as follows:

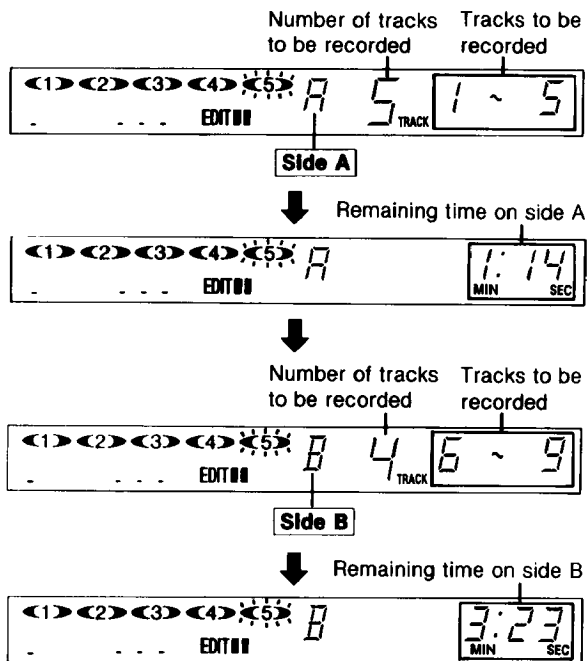

In this example, disc 5 can be recorded with tracks 1–5 on side A and tracks 6–9 on side B of the cassette tape.

4 Press PLAY.

Recording will begin from side A.

When the tracks programmed for tape side A have finished playing, the changer searches for the beginning of the first track to be recorded on side B and switches to the pause mode. When the auto reverse mechanism of the cassette deck works at the end of side A and the tape switches to side B, recording for side B starts automatically.

During recording, the changer automatically makes approximately 3-second silent gaps at the beginning of every track (auto space function).

Depending on the disc, a little sound of the beginning of the next track may be recorded onto the end of the track.

If a cassette deck to be used has no synchro edit function

Start recording on the cassette deck at the same time you press PLAY of this changer.

When the recording for side A is finished, the changer goes into the pause mode. As soon as the cassette deck switches the tape side to B, press PLAY of the changer.

When all the programmed tracks on the specified disc finishes playing, the changer will automatically stop. The edit mode will be cancelled at the same time.

To stop recording

Press STOP and then press the stop button on the cassette deck.

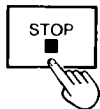

CD Edit-Recording (continued)

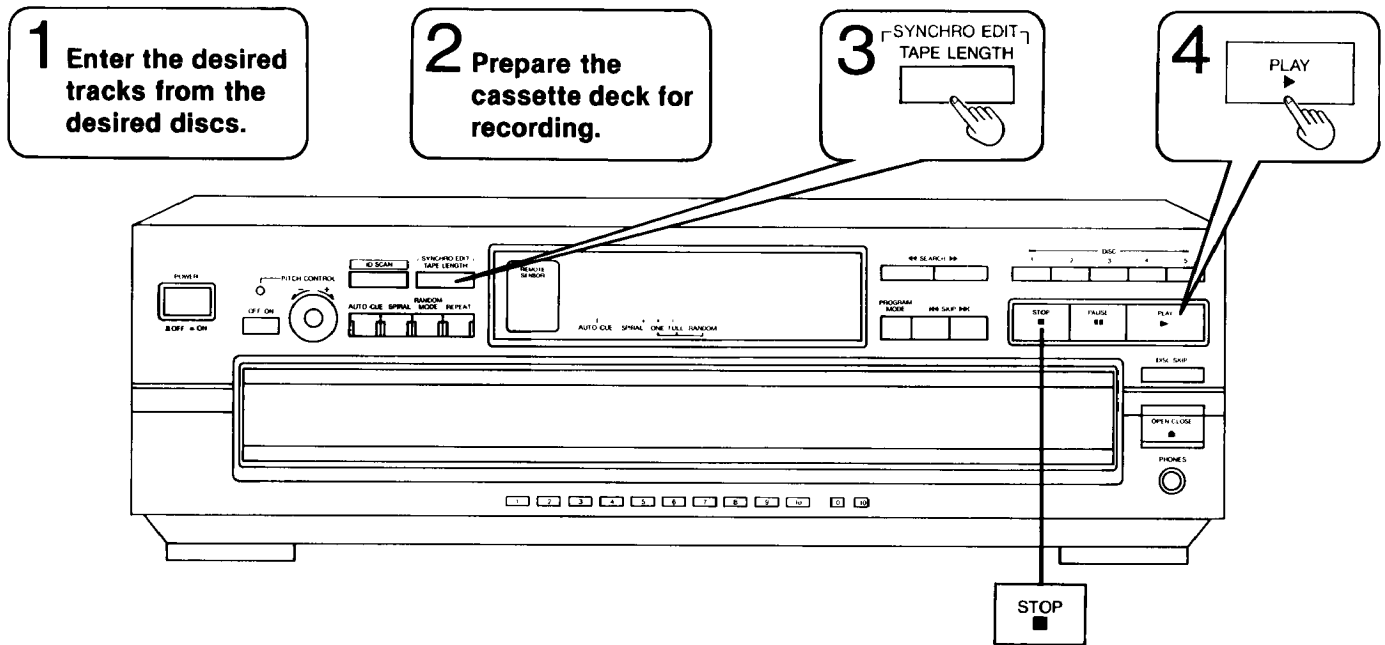

Program-edit-recording

Editing of the selections which you have programmed among the five discs is available.

Note that you cannot get the information regarding the number of tracks that will be recorded and the remaining time on side A and B as in the "Sequential-edit-recording".

Before operation, follow the steps 1–4 of "Basic Operating Procedure" on page 9.

- 1 Enter the desired disc numbers and track numbers following the programming procedure.**

(See pages 14–17.)

For example:

When using a 46-minute tape, you should calculate the total programming time to be recorded (including the 3-seconds silent gap) for each tape side A/B (23 minutes) and program the selections accordingly.

The changer can edit up to 32 selections.

- 2 Prepare the cassette deck for recording.**

1. Insert the cassette tape into the cassette holder of the deck for the synchro edit recording. (Be sure the tape is re-wound.)
 2. Select the noise-reduction system and the reverse mode (↻).
 3. Check to be sure that the forward-side indicator (▶) of the deck to be used is illuminated.
 4. Press PLAY of this changer.
 5. Set the cassette deck on the recording standby mode.
 6. Adjust the recording level.
 7. Press STOP of this changer.
- (Refer to the operating instructions for the cassette deck.)

- 3 Press TAPE LENGTH to select the tape length.**

(See step 3 on page 32.)

For example, if you use a 46-minute tape:

The disc number programmed first

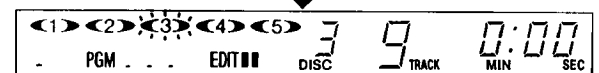
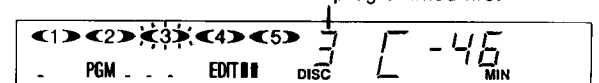

The maximum allowable playing time for editing is 99 minutes.

- 4 Press PLAY.**

Recording will begin from side A.

When the tracks programmed for tape side A have finished playing, the changer switches to the pause mode at the beginning of the first track for side B. When the auto reverse mechanism of the cassette deck works at the end of side A and the tape switches to side B, recording for side B starts automatically.

Depending on the disc, a little sound of the beginning of the next track may be recorded onto the end of the track.

To stop recording

Press STOP and then press the stop button on the cassette deck.

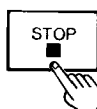

Before Moving

CAUTION:

Before moving this changer to another location, be sure that no discs were left in the changer and that the changer was not switched off while in the play mode.

Failure to do so will expose the compact discs and the changer to the risk of severe damage.

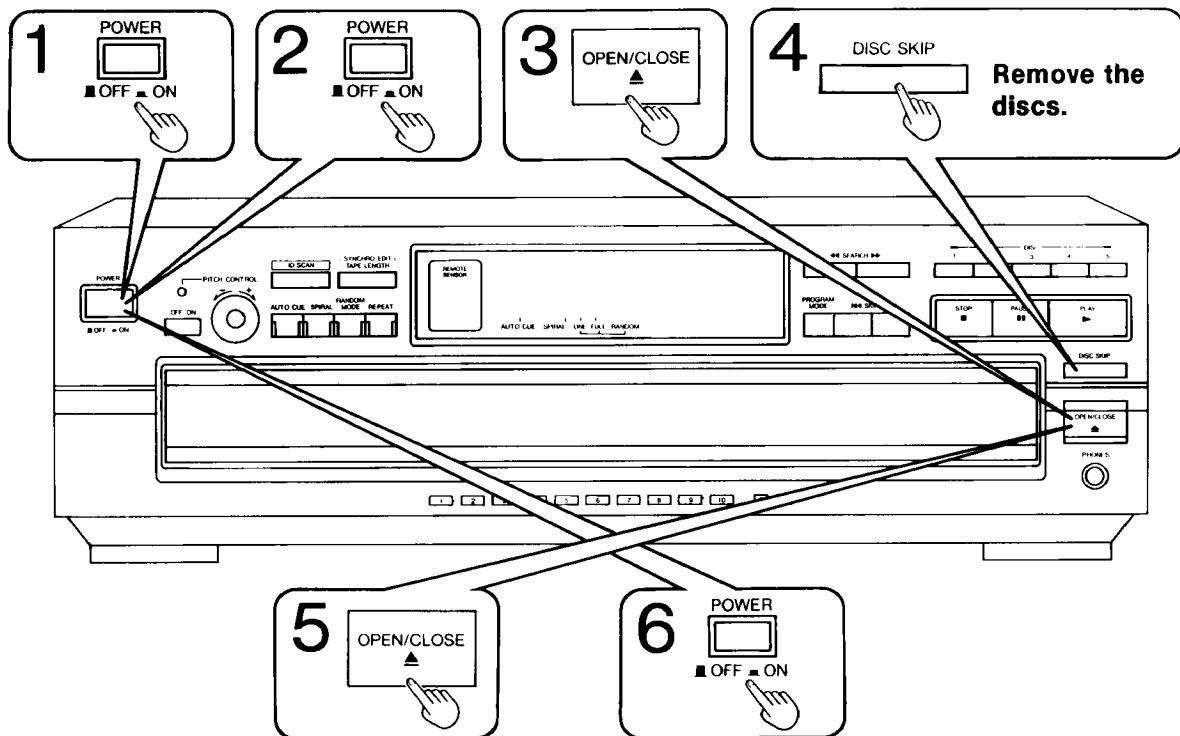

- 1** Press **POWER** to switch off the power.
- 2** Press **POWER** to switch on the power.
- 3** Press **OPEN/CLOSE** to open the loading drawer.
- 4** Press **DISC SKIP** to rotate the disc trays and remove the discs from all disc trays.
- 5** Press **OPEN/CLOSE** to close the loading drawer.
- 6** Press **POWER** to switch off the power.

If you have pressed a wrong button by mistake, return to step 1.

Quick Reference Table of Remote Control Operation

Before using the remote control transmitter, turn on the power switch of the main unit.

Sequential/direct access play

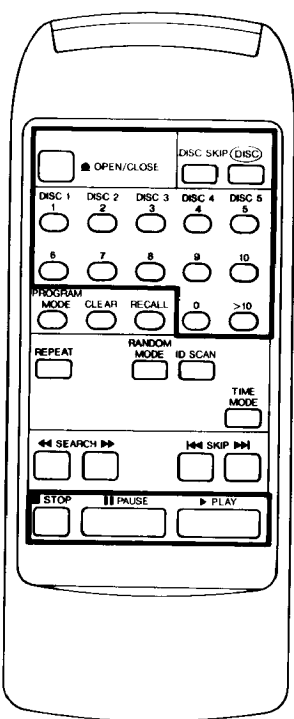
	To open and close the loading drawer	<input type="checkbox"/> OPEN/CLOSE
	To select the disc	DISC SKIP <input type="checkbox"/>
	To specify the disc number	<input type="checkbox"/> DISC → DISC1 DISC2 DISC3 DISC4 DISC5 1 2 3 4 5
	To specify the track number	DISC1 DISC2 DISC3 DISC4 DISC5 1 2 3 4 5 6 7 8 9 10 0 >10 (See page 13)
	To start play	<input type="checkbox"/> PLAY
	To stop play temporarily	<input type="checkbox"/> PAUSE
To stop play	<input type="checkbox"/> STOP	

Random play

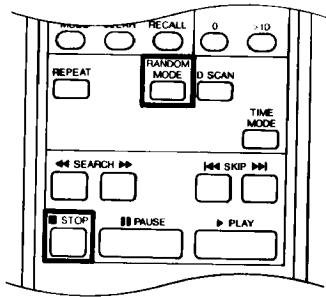
	To start one disc random play	RANDOM MODE <input type="checkbox"/>	Press once when in stop mode.
	To start full random play	RANDOM MODE <input type="checkbox"/>	Press twice when in stop mode.
	To cancel random mode	<input type="checkbox"/> STOP	

Program/delete play

	To start program/delete play	<p>PROGRAM MODE → (DISC) → DISC 1 DISC 2 DISC 3 DISC 4 DISC 5 Select program or delete mode. DISC 1 DISC 2 DISC 3 DISC 4 DISC 5 1 2 3 4 5 6 7 8 9 10 0 >10</p> <p>(See pages 16, 20)</p>
	To check the entered contents	RECALL
	To clear a single item of the entered contents	RECALL → CLEAR → <p>(See pages 17, 21)</p>
	To clear all entered contents	(In the stop mode) ■ STOP
	To cancel program/delete mode	(In the stop mode) PROGRAM MODE <p>Press twice in program mode. Press once in delete mode.</p>

Special features

	To repeat play	REPEAT <p>To cancel repeat mode, press this button again.</p>
	To start ID scan	ID SCAN <p>To cancel ID scan, press this button again.</p>
	To select time mode	TIME MODE <p>(See page 30)</p>
	To search for a desired place	(In the play or pause mode) ◀◀ SEARCH ▶▶ <p>(See page 28)</p>
	To skip a track	◀◀ SKIP ▶▶

Concerning Compact Discs

With this changer, you can only play compact discs having this mark:



Handling precautions

To open the compact disc case, gently press the sides of the top, holding the top at both sides and pull up.

To remove the disc from the case, press the center holder and lift the disc, holding by the edges.

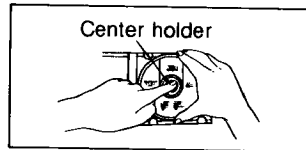
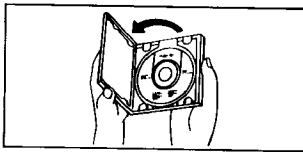

To return the disc to the case, insert the disc with label facing up and press downward at the center.

Hold compact discs by the edges so you will not soil the surface with fingerprints. Fingerprints, dirt and scratches can cause skipping and distortion.

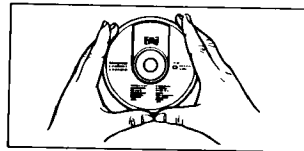
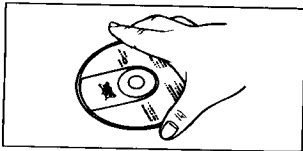

Do not use record cleaning sprays, benzene, thinner, static electricity prevention liquids or any other solvent on disc.

If the surface is soiled, wipe gently with a soft, damp (water only) cloth.

Always move the cloth directly outward from the center of the disc, not in a circular motion as with standard phonograph records.

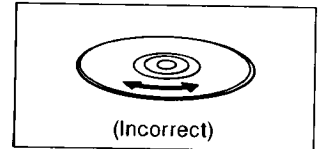
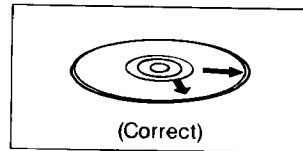

If you are taking the disc from a cold to a warm environment, moisture may form on the disc. Wipe this off with a soft, dry, lint-free cloth before using the disc.

Do not write on the label side with a ball-point pen or other writing instrument.

Storage precautions

Be sure to store discs in their cases to protect them from dust, scratches, and warping.

Do not place or store discs in the following places:

- 1) Locations exposed to direct sunlight.
- 2) Humid or dusty locations.

- 3) Locations directly exposed to a heat vent or heating appliance.
- 4) In the glove compartment or rear deck of an automobile.

Technical Specifications

AUDIO

No. of channels	2 (left and right, stereo)
Frequency response	2-20,000 Hz, ± 1 dB
Output voltage	2 V (at 0 dB)
Dynamic range	92 dB
S/N	100 dB
Total harmonic distortion	0.007% (1 kHz, 0 dB)
Wow and flutter	Below measurable limit
DA converter	MASH (1 bit)
Output impedance	Approx. 1 k Ω
Load impedance	More than 10 k Ω
Headphone output level	3 mW (32 Ω)

GENERAL

Power consumption	13 W
Power supply	AC 120 V, 60 Hz
Dimensions (W x H x D)	430 x 130 x 401 mm (16-15/16" x 5-1/8" x 15-25/32")
Weight	5.0 kg (11.0 lb.)

Note:

Specifications are subject to change without notice. Weight and dimensions are approximate.

PICKUP

Wavelength	780 nm
------------	--------

MASH is a trademark of NTT.

Troubleshooting Guide

Before requesting service for this unit, check the chart below for a possible cause of the problem you are experiencing. Some simple checks or a minor adjustment on your part may eliminate the problem and restore proper operation.

If you are in doubt about some of the check points, or if the remedies indicated in the chart do not solve the problem, refer to the directory of authorized service centers (enclosed with this unit) to locate a convenient service center, or consult your Technics dealer for instructions.

(In U.S.A. consult MSC Authorized Servicenters for detailed instructions.)

Problem	Probable cause(s)	Suggested remedy
Changer will not play.	The disc(s) or other foreign object(s) has fallen inside of the changer.	• Open the loading drawer, then remove the object.
	Moisture has condensed in the changer.	• Switch ON and allow the changer to dry out for about one hour before using the changer.
The disc in the changer does not play.	The disc is upside down.	• Be sure the label is facing upward.
	The disc is dirty.	• Wipe it with a soft cloth.
	The disc is scratched.	• Replace the disc with a new disc.
	The disc is warped.	• Exchange the disc for another one.
A certain music passage can't be played correctly.	The disc is not within specified standards.	• Exchange the disc for another one.
	The disc is dirty.	• Wipe the disc with a soft cloth.
These is noise from the tuner or disturbance on the TV screen.	The disc is scratched.	• Replace the disc with a new one.
	Caused by high-frequency signals of this changer.	• Use the changer farther away from the tuner or TV. • If the tuner's or TV's antenna is the indoor type, use an outdoor one.
When program play is started, an error message (-E) appears on the display.	Playback was started without a track being programmed.	• Program a track.
An error message (-E) appears on the display, and the changer stops operating.	The mechanism of the changer has been improperly adjusted.	• Turn the power switch OFF and then back ON again. However, if the loading drawer is fully open, take out the compact discs (1 or 2) and then turn the power switch OFF and then back ON again.
The loading drawer stops in the middle of opening.		
Remote control does not operate correctly.	The batteries are dead.	• Replace batteries with new ones.
	There is an obstruction between the remote control and the changer.	• Remove the obstruction.
	The batteries are inserted incorrectly. [The (+) and (-) polarities are reversed.]	• Reinsert batteries so that the polarities are correct.

Product Service

Do not attempt to remove the cover(s) or repair the unit yourself. Refer servicing to qualified personnel only.

Product information

For product service, product information or assistance in product operation, refer to the servicenter directory.

Index

- A**uto cue button (**AUTO CUE**) 27
Auto cue function 27
- C**D edit-recording 31–34
Clear button (**CLEAR**) 17, 21
Compact disc edit indicator (**EDIT**) 32
- D**elate play 18–21
Delete play indicator (**DEL**) 18
Direct access play 12–13
Disc buttons (**DISC 1–5**) 12, 14, 18
Disc indicators (**<1> ~ <5>**) 12
Disc number/tape side display 8
Disc skip button (**DISC SKIP**) 10
- F**ull random play 23
- H**eadphones jack (**PHONES**) 11
- I**D scan button (**ID SCAN**) 25
ID scan function 25
ID scan indicator (**SCAN**) 25
- N**umeric buttons (**1–10, 0, >10**) 12, 13
- O**ne disc random play 22
- P**ause button (**|| PAUSE**) 11
Pause indicator (**||**) 11
Pitch control 26
Pitch control button (**OFF/ON**) 26
Pitch control function 26
Play button (**▶ PLAY**) 9
Play indicator (**▶**) 10
Play mode indicators (**▼▼▼**) 22–24
Program-edit-recording 34
Program mode button (**PROGRAM MODE**) 14, 18
Program play 14–17
Program play indicator (**PGM**) 14
- R**andom mode button (**RANDOM MODE**) 22, 23
Recall button (**RECALL**) 17, 21
Repeat button (**REPEAT**) 28
Repeat function 28
Repeat indicator (**⏮**) 28
- S**earch buttons (**◀◀ SEARCH ▶▶**) 28
Search function 28
Sequential-edit-recording 32–33
Sequential play 10–11
Skip buttons (**◀◀ SKIP ▶▶**) 29
Skip function 29
Spiral button (**SPIRAL**) 24
Spiral play 24
Stop button (**■ STOP**) 11
- T**ape length button (**TAPE LENGTH**) 32, 34
Time mode button (**TIME MODE**) 30
Time mode selection 30
Time/program sequence/pitch display 8
Track number display 10

This device complies with Part 15 of the FCC Rules. Operation is subject to the following two conditions: (1) This device may not cause harmful interference, and (2) this device must accept any

interference received, including interference that may cause undesired operation.

This equipment has been tested and found to comply with the limits for a Class B digital device, pursuant to Part 15 of the FCC Rules. These limits are designed to provide reasonable protection against harmful interference in a residential installation. This equipment generates, uses and can radiate radio frequency energy and, if not installed and used in accordance with the instructions, may cause harmful interference to radio communications. However, there is no guarantee that interference will not occur in a particular installation. If this equipment does cause harmful interference to radio or television reception, which can be determined by turning the equipment off and on, the user is

encouraged to try to correct the interference by one of the following measures:

- Reorient or relocate the receiving antenna.
- Increase the separation between the equipment and receiver.
- Connect the equipment into an outlet on a circuit different from that to which the receiver is connected.
- Consult the dealer or an experienced radio/TV technician for help.

Panasonic Company, Division of
Matsushita Electric Corporation of America
One Panasonic Way
Secaucus, New Jersey 07094

Panasonic Sales Company, Division of
Matsushita Electric of Puerto Rico, Inc.
San Gabriel Industrial Park
65th Infantry Ave. Km. 9.5
Carolina, P.R. 00630

Panasonic Company (West) of America, Division of
Matsushita Electric Corporation of America
6550 Katella Ave.
Cypress, CA 90630

Matsushita Electric of Canada Limited
5770 Ambler Drive, Mississauga,
Ontario L4W 2T3

Free Manuals Download Website

<http://myh66.com>

<http://usermanuals.us>

<http://www.somanuals.com>

<http://www.4manuals.cc>

<http://www.manual-lib.com>

<http://www.404manual.com>

<http://www.luxmanual.com>

<http://aubethermostatmanual.com>

Golf course search by state

<http://golfingnear.com>

Email search by domain

<http://emailbydomain.com>

Auto manuals search

<http://auto.somanuals.com>

TV manuals search

<http://tv.somanuals.com>