



Technics®

Center channel /surround speaker system

SB-CSS90

Operating Instructions

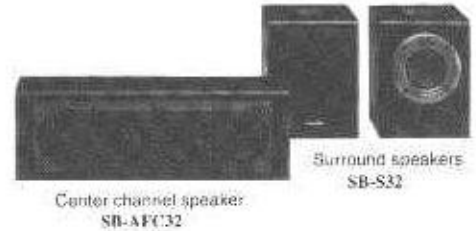

Before operating this unit, please read these instructions completely.

Dear Customer

Thank you for purchasing this Technics product. For optimum performance and safety, please read these instructions carefully.

Supplied accessories

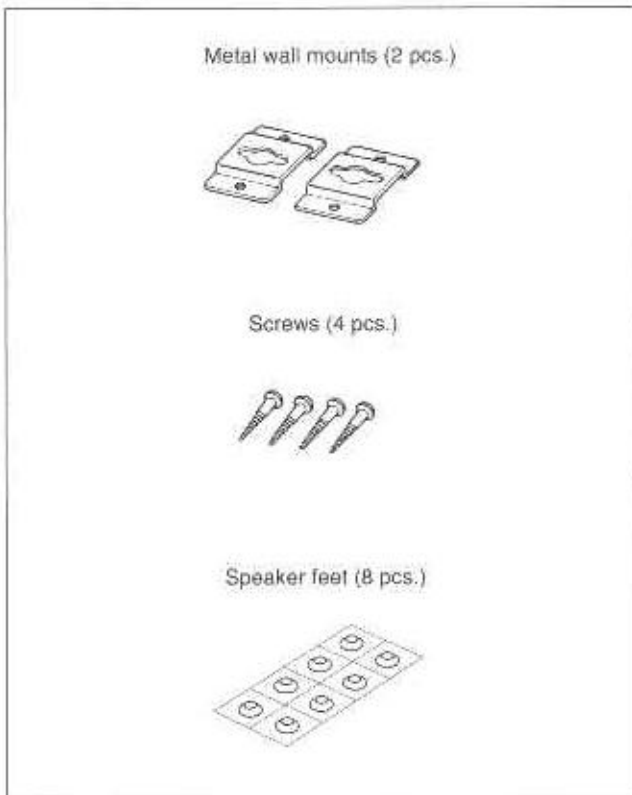

Features

For surround speakers SB-S32

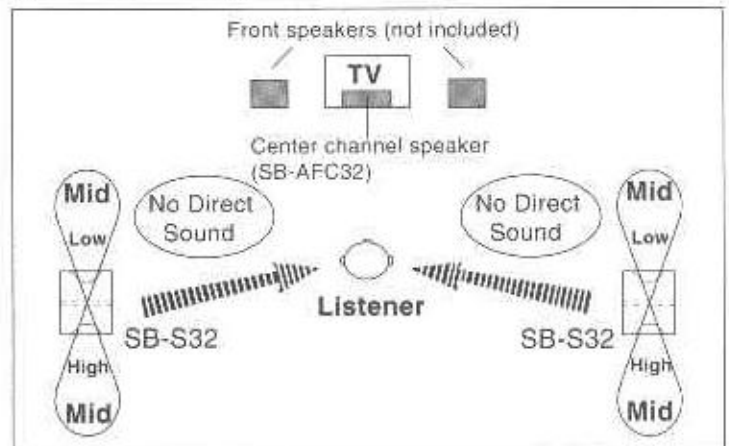

The SB-S32 reproduces low frequency signals from the front and mid-to high frequency signals from the rear. With Technics specially developed mode, the dipole sound field shown in the below figure is created around mid range signals. This means the listener can enjoy natural surround effect without being bombarded by direct sound.

Frequency response

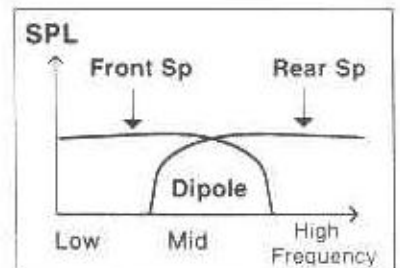

Positioning the speakers

The diagram below shows the basic positioning of each speaker.

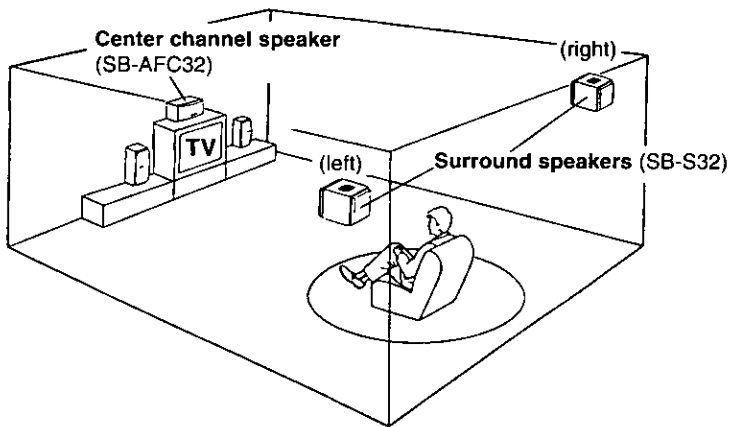

Center channel speaker (SB-AFC32)

Set either on top or underneath the TV.

The center channel speaker is designed so as to be able to be used in close proximity to the TV, but irregular coloring may result due to how the system is placed. If such distortion occurs, turn off the TV for sometime between 15 and 30 minutes. The demagnetizing function of the TV will eliminate the distortion. If the irregular coloring is still visible, then move the speakers further away from the TV.

Please note that if there is a magnetic object near the TV, irregular coloring may result due to the interaction between the TV and the speaker.

The Technics emblem on the speaker cover can be rotated, so adjust its position in accordance with the way the speaker is positioned.

Surround speakers (SB-S32)

Attach the speaker to the wall at a position which is at ear level and slightly behind the listening point.

(See right for the installation procedure.)

If the speaker cannot be attached to the wall, it can alternatively be placed on top of a shelf or on the floor.

The Technics emblem on the speaker cover can be rotated, so adjust its position in accordance with the way the speaker is positioned.

Note

To enjoy the natural surround effect, do not mistake the left speaker for the right, or the front speaker for the rear. The speakers are marked on the top with a label so left and right speakers can be easily identified as well as the way they should be faced.

only for surround speakers SB-S32

Wall installation

The method of installation for the right and left speakers are the same.

Note:

The wall is required to be strong enough to hold a weight of 15 kg.

1. Install the metal wall mounts

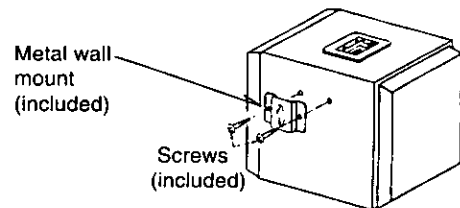

2. Attach the speaker feet

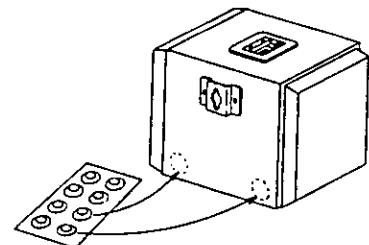

3. Install the speakers on the wall

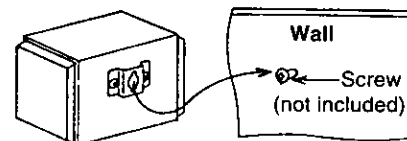

Screw the wood screw into a thick and hard part of the wall.

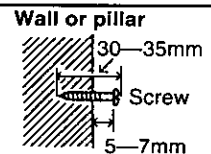

Consult your Technics dealer for details.

When placing on top of a shelf or on the floor

Attach the accessory speaker feet (4) as shown in the illustration below.

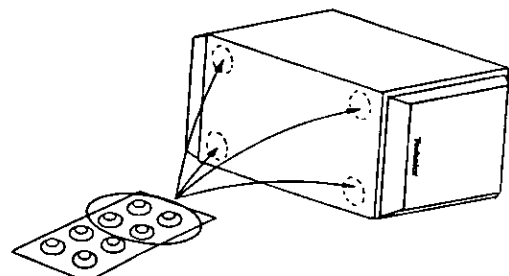

Connections

Notes:

- Before making the connections, switch OFF the power to the receiver.
- Use a receiver having 8Ω or below impedance speaker terminals.
- Be sure to connect only positive (+) wires to positive (+) terminals, and negative (-) wires to negative (-) terminals.

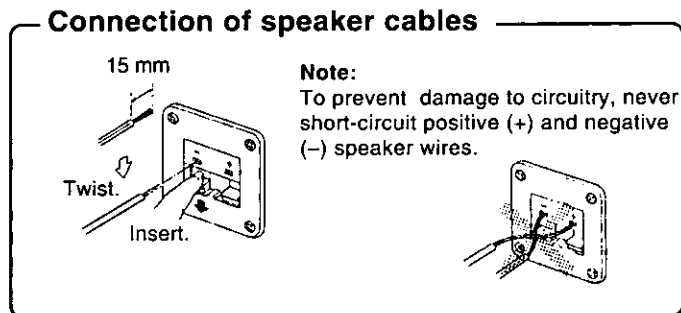
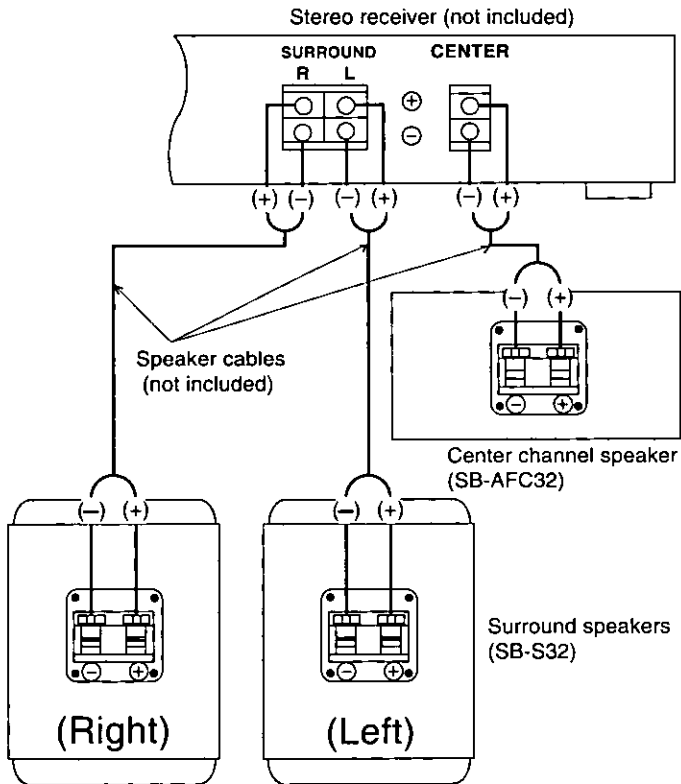

When these speakers are connected to a stereo receiver (not included) in order to enjoy the Dolby Pro Logic System, be sure to set the center mode on the receiver to the "NORMAL" setting.

Notes

1. Be sure to reduce the volume level setting at the receiver when the signal input exceeds the rated allowable input in order to avoid damage to circuitry or other malfunctions.
2. Avoid locations such as described below.
 - In direct sunlight
 - Near heating appliances or other sources of heat
 - Where the humidity is high
3. Never use alcohol, paint thinner, benzine or other similar chemicals to clean the unit as they may damage the finish
4. Do not touch the diaphragms. To do so may cause distortion.

Speaker impedance and allowed input

	Impedance	Allowed input
Center channel speaker	8Ω	130 W (DIN)
Surround speakers	8Ω	80 W (DIN)

Caution

The only receivers you should connect to these speakers are those whose rated output does not exceed the above figures. Using a receiver stronger than that indicated above, you risk blowing either the amp or your speakers, moreover possible fire. If equipment is damaged in any way or unexpected trouble occurs during playback, unplug the system from its outlet and call a serviceman for help.

Protection circuitry

Only for surround speakers SB-S32

This unit incorporates speaker protection circuitry to protect the speaker from damage caused by excessive input or abnormal signals; when excess input is detected, the input is automatically interrupted.

■ If sound is interrupted . . .

1. Reduce the volume setting of the receiver.
2. Check whether or not there is any abnormal condition of the equipment used as the sound source, or of the connections. If there is no abnormal condition, the protection circuitry will be automatically reset minutes later.

■ After the protection circuit is reset . . .

Take care not to increase the receiver's volume level too high.

Technical Specifications

Note:

Specifications are subject to change without notice. Weight and dimensions are approximate.

Center channel speaker SB-AFC32

Type	1-way, 4- speaker system Closed type
Speaker	
Woofer	Full range: 8 cm (3-5/32") cone type
Impedance	8 Ω
Input power	260 W (Music) / 130 W (DIN)
Output sound pressure level	89 dB/W (1.0m) 118 Hz ~ 18 kHz (at-16dB)
Frequency range	138 Hz ~ 14 kHz (at-10dB)
Dimensions (W x H x D)	137 x 421 x 150 mm (5-13/32" x 16-9/16" x 5-29/32")
Weight	3.6 kg (7.9 lb)

Surround speaker SB-S32

Type	2-way, 2- speaker system Bass-reflex
Speaker	
Woofer	Full range: 8 cm (3-5/32") cone type
Impedance	8 Ω
Input power	160 W (Music) / 80 W (DIN)
Output sound pressure level	83 dB/W (1.0m) 80 Hz ~ 45 kHz (-16dB)
Frequency range	120 Hz ~ 40 kHz (-10dB)
Dimensions (W x H x D)	154 x 198 x 250 mm (6-1/16" x 7-25/32" x 9-27/32")
Weight	2.2 kg (4.8 lb)

Matsushita Consumer Electronics
Company, Division of Matsushita
Electric Corporation of America
One Panasonic Way Secaucus,
New Jersey 07094

Panasonic Sales Company,
Division of Matsushita Electric of
Puerto Rico, Inc. ("PSC")
Ave. 65 de Infantería. Km. 9.5
San Gabriel Industrial Park, Carolina,
Puerto Rico 00985

Free Manuals Download Website

<http://myh66.com>

<http://usermanuals.us>

<http://www.somanuals.com>

<http://www.4manuals.cc>

<http://www.manual-lib.com>

<http://www.404manual.com>

<http://www.luxmanual.com>

<http://aubethermostatmanual.com>

Golf course search by state

<http://golfingnear.com>

Email search by domain

<http://emailbydomain.com>

Auto manuals search

<http://auto.somanuals.com>

TV manuals search

<http://tv.somanuals.com>