

# Technics

## CD Stereo System SC-CH404

### Operating Instructions

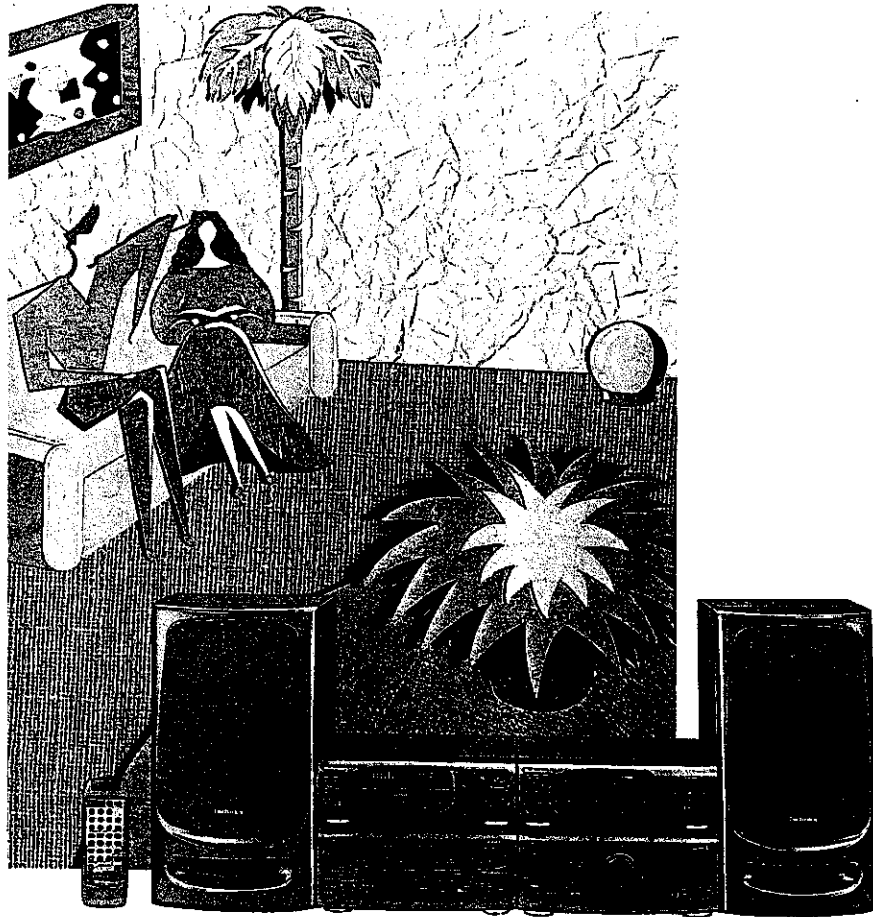

**Notes:**

- The "EB" area code, for example, indicates United Kingdom specifications.
- The "EB" indication shown on the outside packing case indicates United Kingdom.

Before connecting, operating or adjusting this product, please read these instructions completely.

EB GN

COMPACT  
disc  
DIGITAL AUDIO

RQT2107-1B

# Dear customer

Thank you for purchasing this product.  
For optimum performance and safety, please read  
these operating instructions carefully.

These operating instructions are applicable to the following systems.

System	Amplifier	Tuner/sound processor	Compact disc player	Cassette deck	Speakers
SC-CH404	SE-CH404	ST-CH505	SL-CH505	RS-CH404	SB-CH404

**CLASS 1  
LASER PRODUCT**

(Back of product)

## CAUTION!

THIS PRODUCT UTILIZES A LASER.  
USE OF CONTROLS OR ADJUSTMENTS OR PERFORMANCE OF PROCEDURES OTHER THAN THOSE SPECIFIED HEREIN MAY RESULT IN HAZARDOUS RADIATION EXPOSURE.  
DO NOT OPEN COVERS AND DO NOT REPAIR YOURSELF. REFER SERVICING TO QUALIFIED PERSONNEL.

**DANGER-Invisible  
laser radiation when  
open.  
AVOID DIRECT EX-  
POSURE TO BEAM.**

(Inside of product)

THIS TUNER/RECEIVER IS CAPABLE OF RECEIVING THE NEW AM STEREO BROADCASTS FROM THE AM BAND RADIO STATIONS. HOWEVER LIKE MANY TUNERS AND RECEIVERS CURRENTLY AVAILABLE ON THE MARKET IT WILL REPRODUCE THIS AM STEREO SIGNAL ONLY IN AM MONO, WHICH, IN EFFECT, IS OF NO LESSER QUALITY THAN YOUR EXISTING AM MONO TUNER/RECEIVER.

# Table of contents

## Before use

Caution for AC mains lead .....	4
Suggestions for safety .....	5
Supplied accessories .....	6
Location of controls .....	7
Amplifier section .....	7
Tuner/sound processor section .....	7
Compact disc player section .....	8
Cassette deck section .....	8

## Preparations

Installation .....	9
Stacking the components .....	9
Connections .....	10
Optional antenna connections .....	12
External unit connection .....	13
Concerning the multi-control section .....	14
Demonstration function .....	15
Concerning the remote control .....	16
Battery installation .....	16
Correct method of use .....	16
Setting the time .....	17
Memory presetting .....	18
Automatic memory presetting .....	18
Manual memory presetting .....	19

## Compact disc operations

Listening to compact discs .....	20
Sequential play .....	20
Direct access play .....	22
Random play .....	22
Program play .....	23

## Radio operations

Listening to radio broadcasts .....	24
Manual tuner operation .....	24
Memory tuner operation .....	24

## Tape deck operations

Listening to tapes .....	25
Playback .....	25
Sequential playback among 2 tapes .....	27

## Convenient functions

Convenient functions .....	28
Easy play .....	28
To mute the volume .....	28
To use headphones .....	28

## Recording operations

Making a recording from radio broadcasts .....	29
Recording from compact discs .....	31
One-touch editing preparation .....	32
To start one-touch editing .....	32
Linking up several discs (LINK) .....	34
Synchro recording .....	35
Tape-to-tape recording .....	36

## Tone quality operations

Changing the tone .....	37
About equalization curves (EQ) .....	37
About simulated listening environments (SPACE) .....	37
To retrieve the preprogrammed equalization curves (EQ mode) .....	38
To retrieve the preprogrammed simulated listening environments (SPACE mode) .....	39
To adjust EQ and SPACE ("USER" mode) .....	40
To listen with augmented bass (V.BASS) .....	40

## Timer operations

Using the timer .....	41
About the types of timer operation .....	41
Setting the play timer .....	42
Setting the record timer .....	44
To use the sleep timer .....	46
To use each timer mode in conjunction .....	47

## Microphone mixing

Enjoying the microphone mixing .....	48
--------------------------------------	----

## External unit operations

Using an external unit .....	49
Listening to an external source .....	49
Recording from an external source .....	49

## Reference



Remote control operations	
—quick reference— .....	50
Concerning compact discs .....	52
Maintenance .....	53
Concerning cassette tapes .....	53
Troubleshooting guide .....	54
Technical specifications .....	Back cover

# Caution for AC mains lead

## (For United Kingdom)

("EB" area code model only)

For your safety, please read the following text carefully.

This appliance is supplied with a moulded three pin mains plug for your safety and convenience. A 5-ampere fuse is fitted in this plug. Should the fuse need to be replaced please ensure that the replacement fuse has a rating of 5-ampere and that it is approved by ASTA or BSI to BS1362. Check for the ASTA mark  or the BSI mark  on the body of the fuse.

If the plug contains a removable fuse cover you must ensure that it is refitted when the fuse is replaced. If you lose the fuse cover the plug must not be used until a replacement cover is obtained. A replacement fuse cover can be purchased from your local dealer.

### CAUTION!

IF THE FITTED MOULDED PLUG IS UNSUITABLE FOR THE SOCKET OUTLET IN YOUR HOME THEN THE FUSE SHOULD BE REMOVED AND THE PLUG CUT OFF AND DISPOSED OF SAFELY.

THERE IS A DANGER OF SEVERE ELECTRICAL SHOCK IF THE CUT OFF PLUG IS INSERTED INTO ANY 13-AMPERE SOCKET.

If a new plug is to be fitted please observe the wiring code as shown below.  
If in any doubt please consult a qualified electrician.

### IMPORTANT

The wires in this mains lead are coloured in accordance with the following code:

Blue: Neutral

Brown: Live

As the colours of the wires in the mains lead of this appliance may not correspond with the coloured markings identifying the terminals in your plug, proceed as follows:

The wire which is coloured BLUE must be connected to the terminal in the plug which is marked with the letter N or coloured BLACK.

The wire which is coloured BROWN must be connected to the terminal in the plug which is marked with the letter L or coloured RED.

Under no circumstances should either of these wires be connected to the earth terminal of the three pin plug, marked with the letter E or the Earth Symbol .

### Before use

Remove the connector cover as follows.

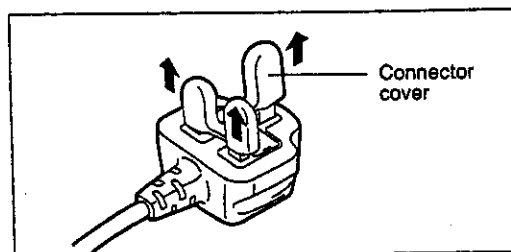

### How to replace the fuse

1. Remove the fuse cover with a screwdriver.

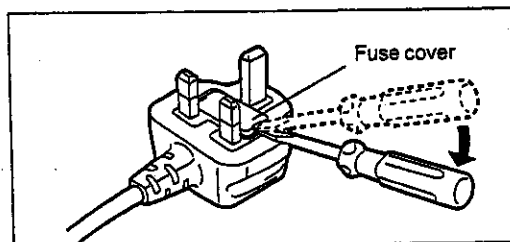

2. Replace the fuse and attach the fuse cover.

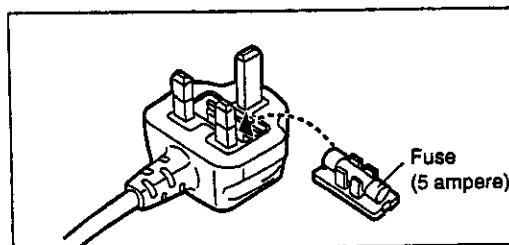

# Suggestions for safety

## ■ Use a standard AC wall outlet

1. Use from an AC power source of high voltage, such as that used for an air conditioner, is very dangerous.  
A fire might be caused by such a connection.
2. A DC power source cannot be used.  
Be sure to check the power source carefully, especially on a ship or other place where DC is used.

## ■ Grasp the plug when disconnecting the power supply cord

1. Wet hands are dangerous.  
A dangerous electric shock may result if the plug is touched by wet hands.
2. Never place heavy items on top of the power supply cord, nor force it to bend sharply.

## ■ Place the unit where it will be well ventilated

Place this unit at least 10 cm (4") away from wall surfaces, etc.  
Be careful that curtains and similar materials do not obstruct the ventilation holes.

## ■ Avoid places such as the following:

In direct sunlight or in other places where the temperature is high.

In places where there is excessive vibration or humidity.

Such conditions might damage the cabinet and/or other component parts and thereby shorten the unit's service life.

- ## ■ Be sure to place the unit on a flat, level surface.
- If the surface is inclined, a malfunction may result.

## ■ Never attempt to repair nor reconstruct this unit

A serious electric shock might occur if this unit is repaired, disassembled or reconstructed by unauthorized persons, or if the internal parts are accidentally touched.

## ■ Take particular care if children are present

Never permit children to put anything, especially metal, inside this unit. A serious electric shock or malfunction could occur if articles such as coins, needles, screwdrivers, etc. are inserted through the ventilation holes, etc. of this unit.

## ■ If water is spilled on the unit

Be extremely careful if water is spilled on the unit, because a fire or serious electric shock might occur. Immediately disconnect the power cord plug, and consult with your dealer.

## ■ Avoid spray-type insecticides

Insecticides might cause cracks or "cloudiness" in the cabinet and plastic parts of this unit. The gas used in such sprays might, moreover, be ignited suddenly.

## ■ Never use alcohol or paint thinner

These and similar chemicals should never be used, because they might cause flaking or cloudiness of the cabinet finish.

## ■ Disconnect the power supply cord if the unit will not be used for a long time

If the unit is left for a long time with the power ON, this not only will shorten its useful operation life, but also may cause other trouble.

## ■ If trouble occurs

If, during operation, the sound is interrupted or indicators no longer illuminate, or if an abnormal odour or smoke is detected, immediately disconnect the power cord plug, and contact with your dealer or an Authorized Service Center.

# Supplied accessories



Please check and identify the supplied accessories.

<input type="checkbox"/> AC power supply cord ..... 1 pc. (For United Kingdom: VJA0733) (For others: RJA0036-K)
<input type="checkbox"/> Remote control transmitter ..... 1 pc. (RAK-CH115WH)
Flat cable <input type="checkbox"/> (Long) ..... 1 pc. (REX0511)
<input type="checkbox"/> (Short) ..... 1 pc. (REX0512)
<input type="checkbox"/> LW/MW antenna ..... 1 pc.
<input type="checkbox"/> FM indoor antenna ..... 1 pc. (For United Kingdom: RSA0007) (For others: RSA0006)

<input type="checkbox"/> Speaker cords ..... 2 pcs. (REE0499)
<input type="checkbox"/> Remote control batteries ..... 2 pcs. (UM-4, AAA, R03)
<input type="checkbox"/> Antenna holder ..... 1 pc. <input type="checkbox"/> Screw ..... 1 pc.
<input type="checkbox"/> Attachment plug ..... 1 pc. (For United Kingdom only: SJP9009)

**Note**

The configuration of the AC power supply cord and FM indoor antenna differ according to the area.

# Location of controls

The functions indicated by the numbers with black background (for example ❶) can also be activated from the remote control transmitter. (See pages 50–51.)

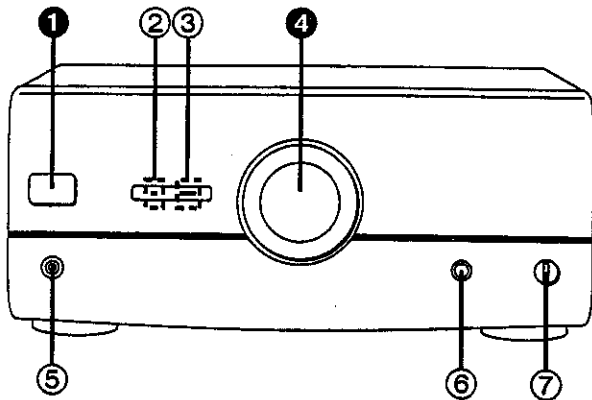
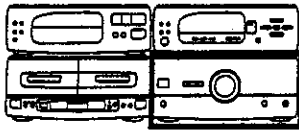

## Amplifier section

No.	Name	Ref. page
❶	Power "STANDBY $\odot$ /ON" switch (POWER, STANDBY $\odot$ /ON)	17
	Press to switch the unit from on to standby mode or vice versa. In standby mode, the unit is still consuming a small amount of power.	
❷	Standby indicator (STANDBY)	
	When the unit is connected to the AC mains supply, this indicator lights up in standby mode and goes out when the unit is turned on.	
❸	Power indicator (POWER)	
❹	Volume control (VOLUME)	20
❺	Headphones jack (PHONES)	28
❻	Microphone jack (MIC)	48
❼	Microphone volume control (MIC VOLUME)	48

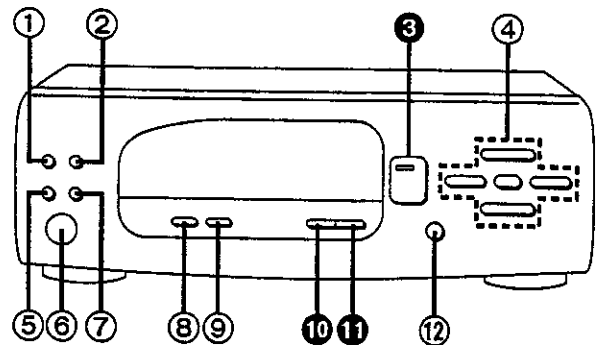
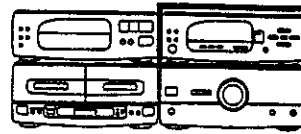

## Tuner/sound processor section

No.	Name	Ref. page
❶	External source input select button (EXT)	49
❷	Internal source input select button (INT)	
❸	Tuner source/band select button and Indicator (TUNER/BAND)	18
❹	Multi-control buttons (MULTI CONTROL)	14, 17, 18, 38, 42
❺	Record timer button (☐ REC)	45
❻	Remote control signal sensor (SENSOR)	16
❼	Play timer button (☐ PLAY)	43
❽	V.bass button (V.BASS)	40
❾	Voice mute button (KARAOKE)	48
❿	EQ/SPACE mode ON/FLAT button (ON/FLAT)	38, 39
⓫	EQ/SPACE mode select button (MODE)	38
⓬	Clock/timer button (CLOCK/TIMER)	17, 42–46

## Location of controls

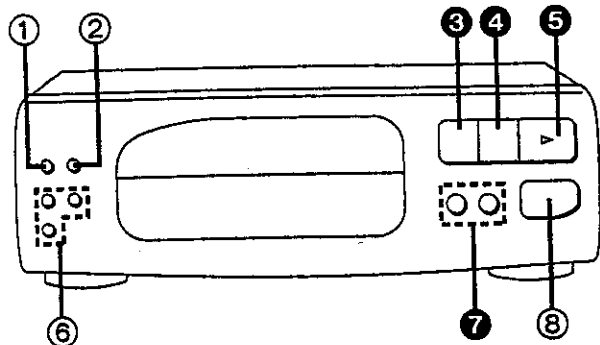
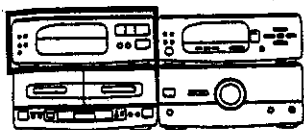

### Compact disc player section

No.	Name	Ref. page
①	Random play button (RANDOM)	22
②	Repeat button (REPEAT)	21
③	Stop button (□)	20
④	Pause button (⏸)	20
⑤	Play button and indicator (▶)	20
⑥	CD edit buttons (J.FIT, ALBUM, LAST FADE)	32
⑦	Skip/search buttons (-SKIP/-SEARCH, ⏮/⏪, ⏩/⏭)	21
⑧	Disc tray open/close button (▲ OPEN/CLOSE)	20

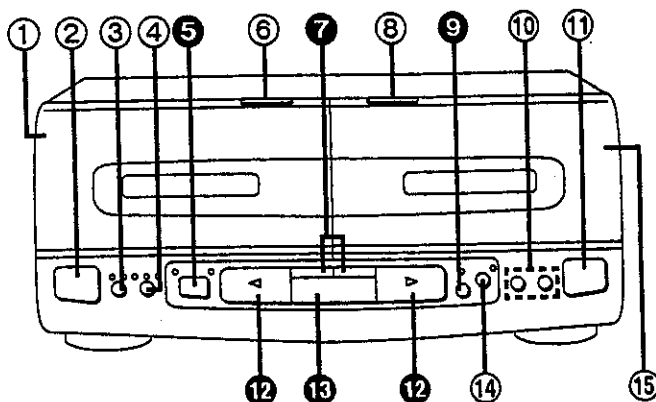
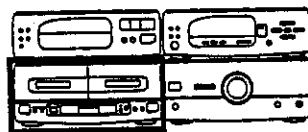

### Cassette deck section

No.	Name	Ref. page
①	Deck 1 cassette holder	25
②	Deck 1 cassette holder open button (▲ OPEN)	25
③	Dolby noise reduction button and indicators (DOLBY NR)	25
④	Reverse mode button and indicators (REVERSE MODE)	25
⑤	Deck 1/deck 2 select button and indicators (DECK 1/2)	25
⑥	Deck 1 cassette holder close button (CLOSE)	25
⑦	Fast forward/rewind/tape program sensor buttons [◀◀ (TPS), (TPS) ▶▶]	26
⑧	Deck 2 cassette holder close button (CLOSE)	27
⑨	Record pause button and indicator (REC PAUSE)	29
⑩	One-touch tape edit buttons (NORMAL, HIGH)	36
⑪	Deck 2 cassette holder open button (▲ OPEN)	29
⑫	Playback buttons and indicators (◀, ▶)	25
⑬	Stop button (□)	25
⑭	CCRT button and indicator (CCRT)	29
⑮	Deck 2 cassette holder	29



# Installation

## Stacking the components

Install the various components as shown below.

### Horizontal stacking

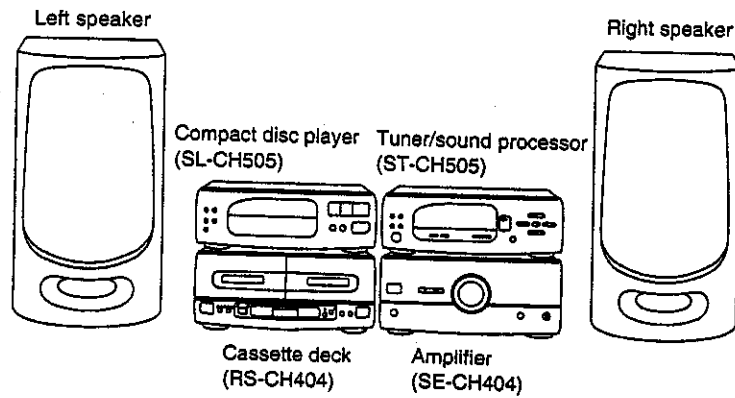

### Vertical stacking

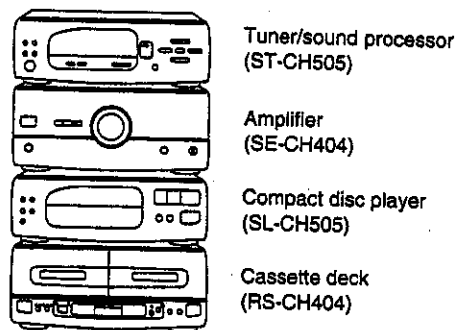

### System layout example

- ① Left speaker
- ② This system
- ③ Right speaker
- ④ Surround speakers

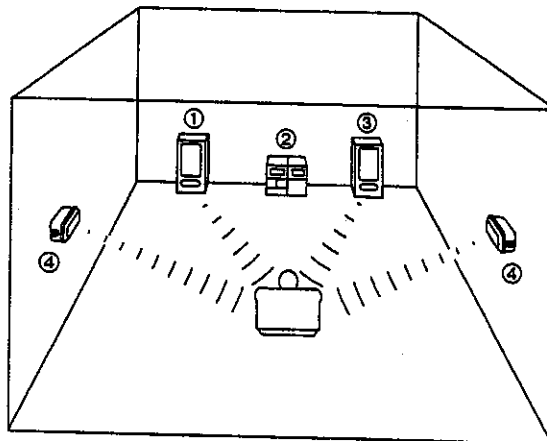

To produce a better stereo sound, install both speakers away from the system.

Surround sound effect differs according to where you install the surround speakers. Install them as you like.

# Connections

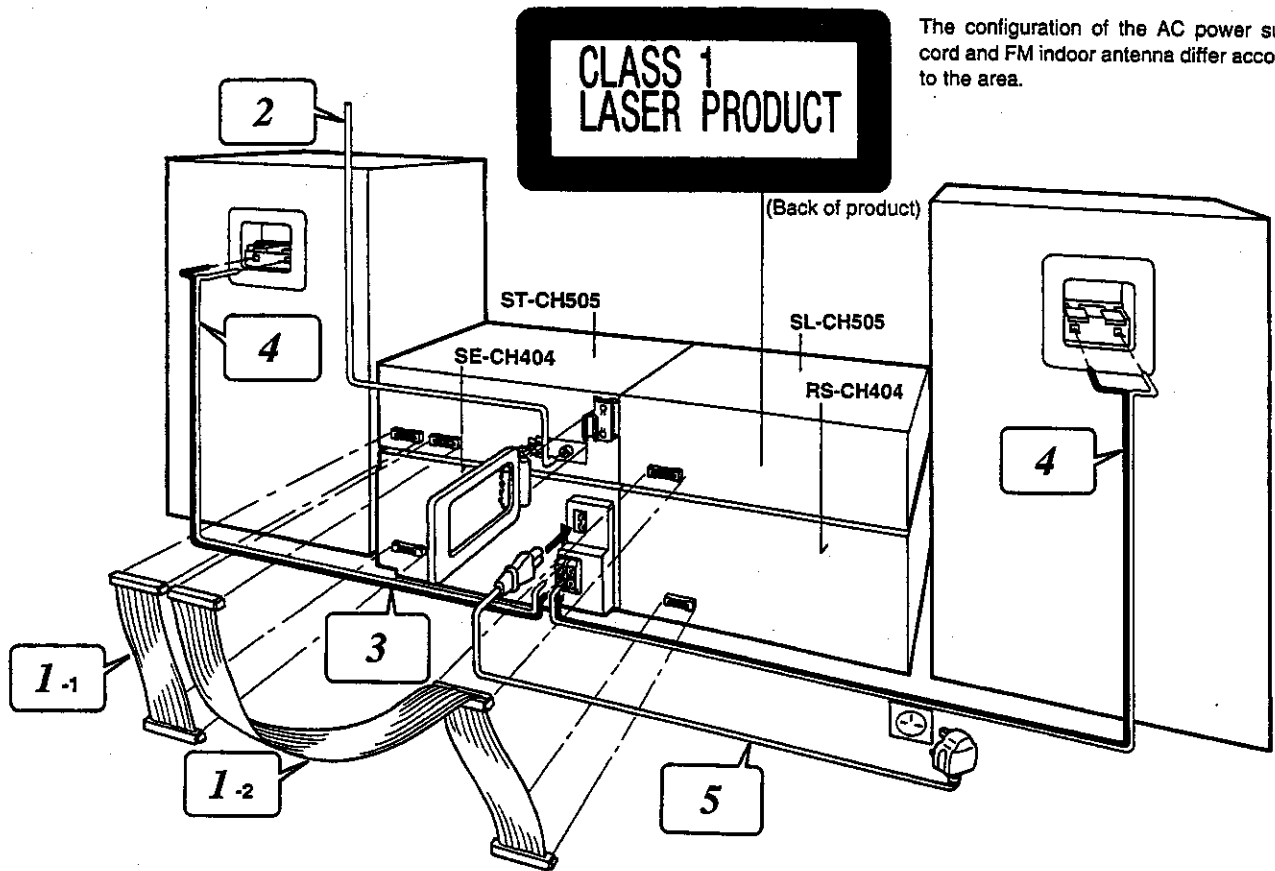

The configuration of the AC power supply cord and FM indoor antenna differ according to the area.

## 1 Connect the flat cable.



1. Connect the shorter flat cable to the terminal of the tuner/sound processor and amplifier.
2. Connect the longer flat cable to the terminal of the tuner/sound processor, compact disc player, and cassette deck.

Route the cable horizontally (underneath the heat outlet grille) so that the side with the white-coloured lead is positioned at the front.

Be sure to connect the blue-coloured connector to B1 (tuner/sound processor).

After connection, fold and press the cable as flat to the back of the unit as possible.

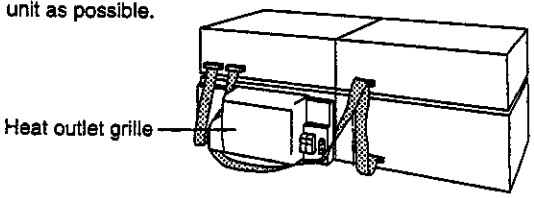

**Do not try connecting or disconnecting the flat cable while the power is switched to ON.**

## 2 Connect the FM indoor antenna.

Install the antenna on a wall at a height and in a direction which result in the best reception.

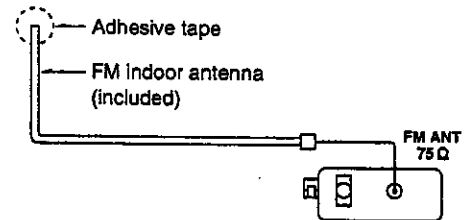

The tip of the internal antenna wire should not come into contact with any metal objects. When you cannot get a good reception with this FM indoor antenna, we recommend you install an FM outdoor antenna. (Not included. See page 12.)

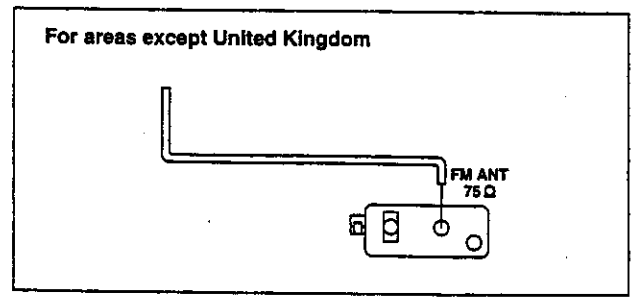

### 3 Connect the LW/MW loop antenna.

1. Attach the antenna holder to the rear panel of the tuner/sound processor.
2. Clamp the antenna to the antenna holder and connect the antenna terminal to the rear panel of the tuner/sound processor.
3. Position the loop for the best reception.

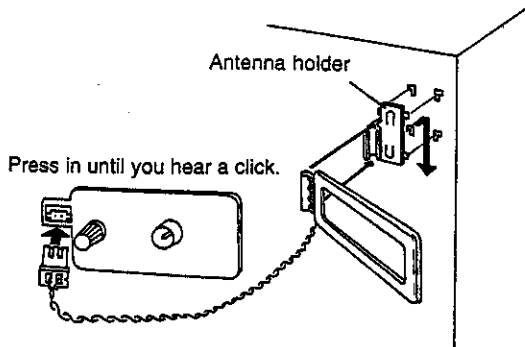

You may attach the LW/MW antenna holder with screw (included) to a rack or other structure. In this case, attach as showed in the figure below.

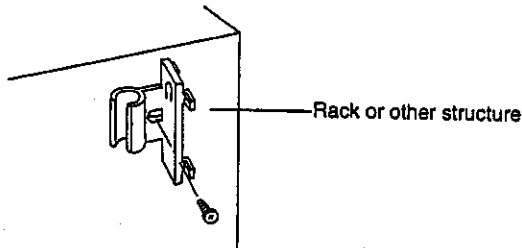

**Note**

To minimize noise pickup, keep the LW/MW loop antenna cord along the heat outlet grille, and away from the flat cables.

### 4 Connect the right (R) and left (L) speaker cables.

**Notes**

- Be sure to connect speaker cables before connecting the AC power supply cord.
- The load impedance of any speaker used with this unit must be 6-8Ω.
- Match the two wires from the left and right speaker cables with the same coloured levers of the speaker terminals, then insert the wires into the respective terminals.

1. Strip off the outer covering, and twist the center conductor.

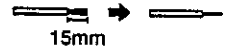

Make sure the bare ends of the wires are not unraveled. (If they are, twist them tight again.)

2. ① Tilt the lever back and insert the wire.  
② Close the lever and pull the cord gently to be sure that it is secured.

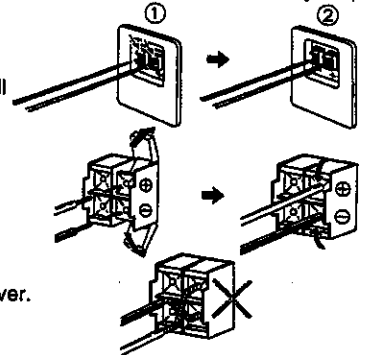

- The configuration of the speaker terminals differs depending on the area.

3. Insert the wire to the rear panel of the amplifier, and close the lever.

**Notes**

- To prevent damage to circuitry, never short-circuit positive (+) and negative (-) speaker wires.
- Be sure to connect only positive (red) wires to positive (+) terminals and negative (black) wires to negative (-) terminals.

**For United Kingdom**

**BE SURE TO READ THE CAUTION FOR AC MAINS LEAD ON PAGE 4 BEFORE PROCEEDING TO STEP 5.**

### 5 Connect the AC power supply cord after you have connected all other cables.

**For United Kingdom  
Insertion of Connector**

Even when the connector is perfectly inserted, depending on the type of inlet used, the front part of the connector may jut out as shown in the drawing.

However there is no problem using the unit.

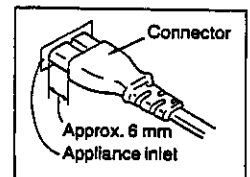

**Optional antenna connections**

**FM outdoor antenna (not included)**

If the FM indoor antenna does not provide satisfactory reception of FM broadcasts, use an outdoor antenna.

You may need an outdoor antenna if you use this system in a mountainous region or inside a reinforced-concrete building, etc. An outdoor antenna should be installed by a competent technician only.

FM outdoor antenna

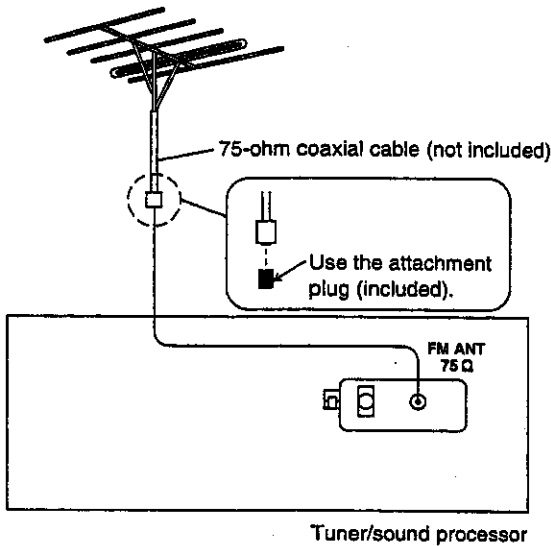

**For areas except United Kingdom (FM outdoor antenna)**

1. Remove a piece of the outer vinyl sheath from the end.

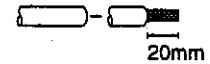

2. Bundle the shield braid, and remove a piece of the inner vinyl sheath covering the core wire.

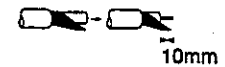

3. Connect the core wire and the shield braid.

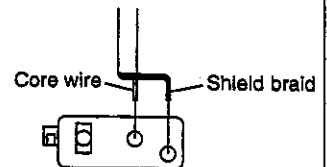

**LW/MW outdoor antenna (not included)**

An outdoor antenna may be required in a mountainous region, or if this system is located inside a reinforced-concrete building, etc.

Run 5 to 12 m of vinyl-covered wire horizontally along a window or other convenient location.

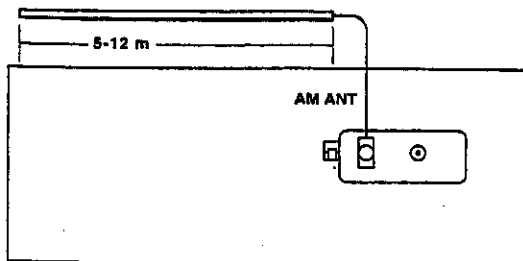

**Note**

Do not remove the LW/MW loop antenna.

**For areas except United Kingdom (LW/MW outdoor antenna)**

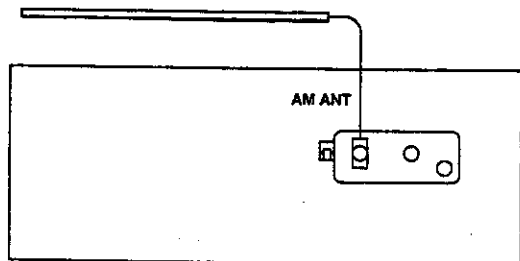

Tuner/sound processor

**External unit connection**

**DCC (digital compact cassette deck) or DAT (digital audio tape deck)**

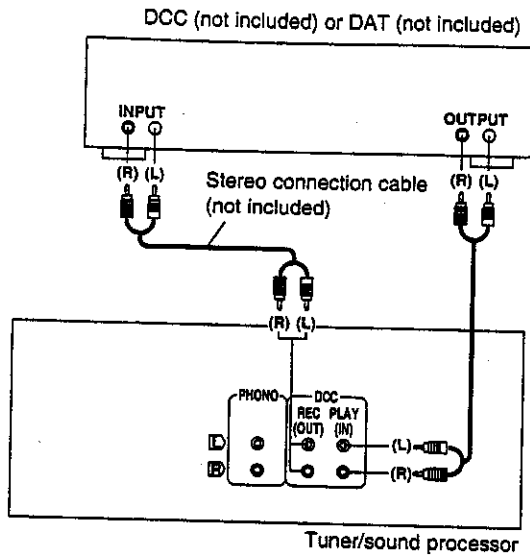

**Rear surround speakers**

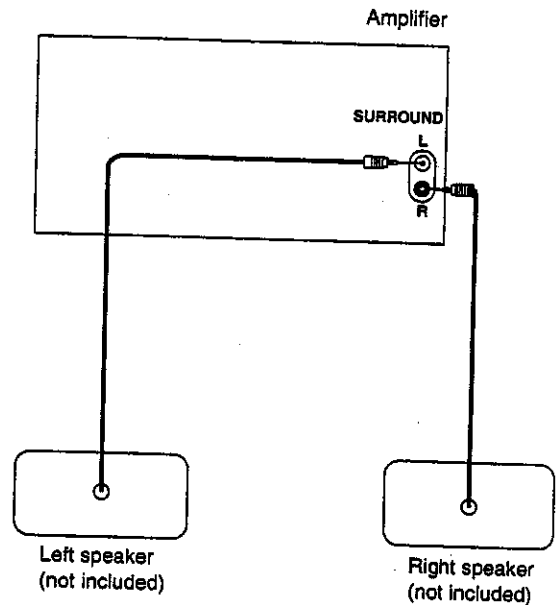

**Analog player**

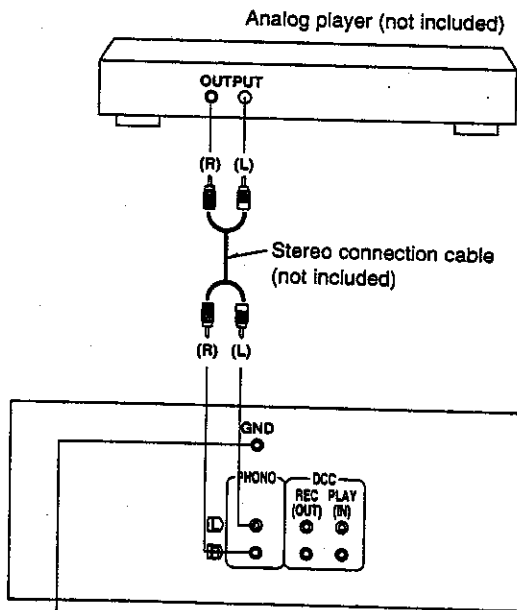

**For United Kingdom only:** Tuner/sound processor "GND" terminal  
This terminal is for a ground wire use.

**For the set with "AUX" terminal instead of "PHONO":**  
Use an analog player which has built-in phono equalizer.

**Note**

Be sure to connect both speaker systems. If only one side is connected, no sound will be heard.

Install each speaker left and right at the back of the listening space.

# Concerning the multi-control section

Using the multi-control buttons, you can make following operation.

- Clock/timer settings
- Tuning or presetting the radio station
- Selecting or adjusting the EQ or SPACE mode

When operating, the display shows which buttons are available for the operation.

The chart below shows the display and the available buttons for each operation.

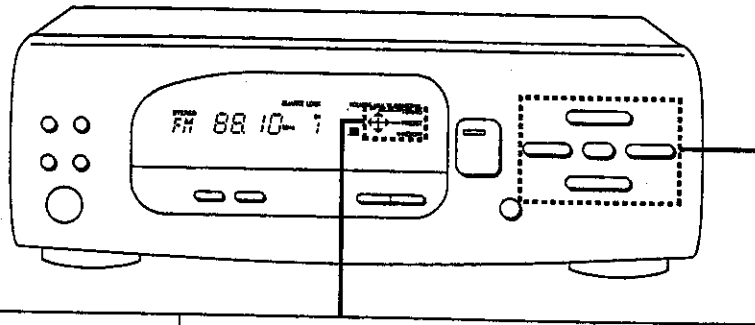

Operation	Display	Available buttons
<p>■ <b>Clock/timer operation</b></p> <ul style="list-style-type: none"> <li>• Time setting (See page 17.)</li> <li>• Record timer setting (See pages 44–45.)</li> <li>• Play timer setting (See pages 42–43.)</li> <li>• Sleep timer setting (See page 46.)</li> </ul>	<p><b>MULTI CONTROL</b></p> <p><b>SET ●</b></p>	<p><b>MULTI CONTROL</b></p>
<p>■ <b>Radio operation</b></p> <ul style="list-style-type: none"> <li>• Automatic memory presetting</li> <li>• Manual memory presetting (See page 19.)</li> <li>• Manual tuner operation (See page 24.)</li> <li>• Memory tuner operation (See page 24.)</li> </ul>	<p><b>MULTI CONTROL TUNING</b></p> <p><b>● MEMORY</b></p>	<p><b>MULTI CONTROL</b></p>
<p>■ <b>EQ/SPACE operation</b></p> <ul style="list-style-type: none"> <li>• The EQ/SPACE mode selection (See pages 38–39.)</li> </ul>	<p><b>MULTI CONTROL</b></p> <p><b>SELECT</b></p>	<p><b>MULTI CONTROL</b></p>
<ul style="list-style-type: none"> <li>• The EQ/SPACE mode effect adjustment (See page 40.)</li> </ul>	<p><b>MULTI CONTROL</b></p> <p><b>SELECT</b></p>	<p><b>MULTI CONTROL</b></p>

## Demonstration function

By keeping pressed V.BASS, the demonstration example shows on the display alternately.

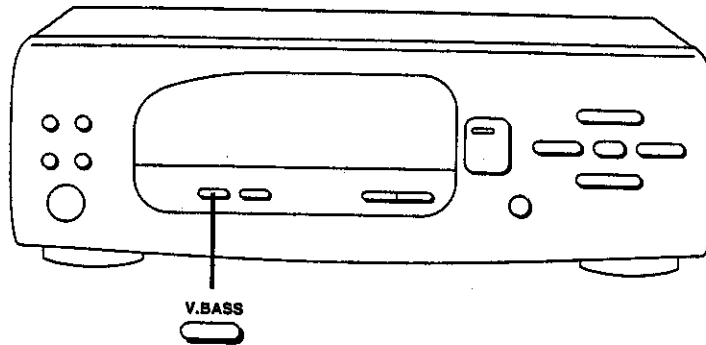

**Press and hold V.BASS.**

V.BASS



The display will change alternately showing the display example when the multi control buttons are used.  
To cancel, press any button on the system.

# Concerning the remote control

## Battery installation

Insert two R03/L03 (UM-4 or equivalent, not included) batteries as shown below.

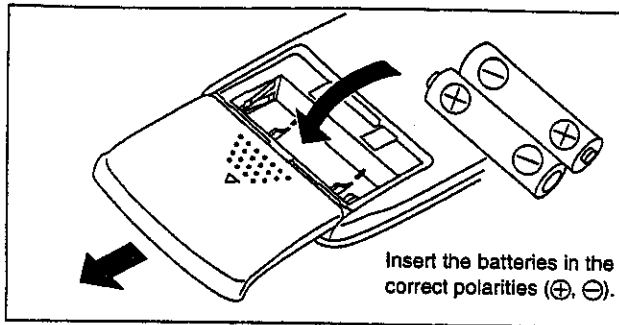

To remove the batteries, pull out the + side.

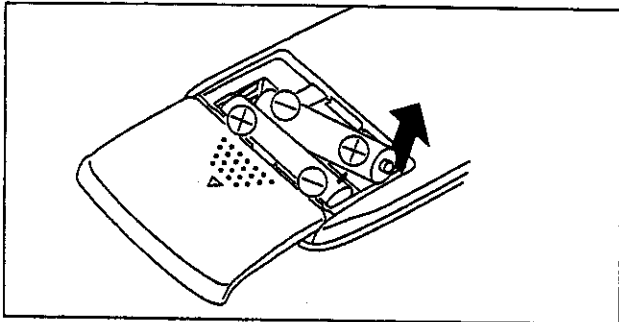

## Use of batteries

- Do not mix old and new batteries, or batteries of different types (carbon and alkaline, etc.).
- Always remove old, weak or worn-out batteries promptly and dispose of them properly.
- Never subject batteries to excessive heat or flame; do not attempt to disassemble them; and be sure they are not short-circuited.
- If the remote control is not to be used for a long period of time, remove the batteries and store them in a cool, dark place.
- If a battery leaks, remove all batteries and dispose of them properly.
- Thoroughly clean the battery compartment before inserting new batteries.
- If the electrolyte comes into contact with skin or clothes, flush with water immediately.
- Keep batteries out of reach of children.
- Do not use rechargeable (nickel-cadmium) type batteries.
- Do not attempt to recharge alkaline or carbon batteries.

## Battery life

The battery life is about one year.

- Although the battery life varies depending on how often the device is used, the batteries should be replaced about once every year.
- The batteries should be replaced if commands from the remote control transmitter do not operate the unit even when the transmitter is held close to the front panel.

## Correct method of use

Use the remote control within 60 degrees and within 7 meters (23 ft.) facing directly toward the unit's remote control signal sensor.

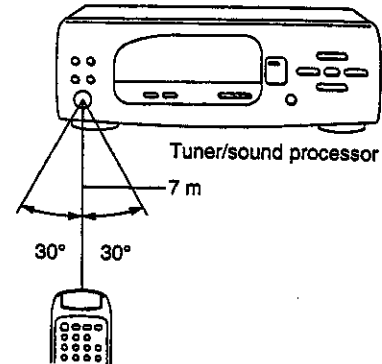

Face about 7 meters in front of the sensor.  
(This actual range will depend on the angle at which the remote control is used.)

## Operation notes

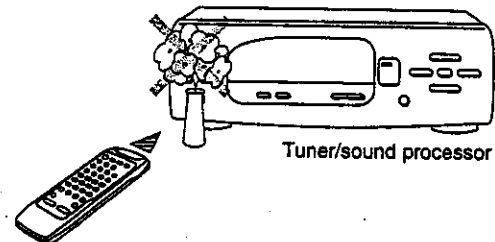

- Aim the remote control's transmission window toward the unit's sensor. Avoid any obstacles.

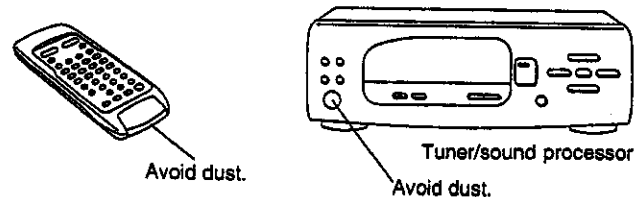

- Be sure the transmission window and the unit's sensor are free from dust. Excessive dust might affect its performance.
- The operation may not be correct if direct sunlight or other strong light source strikes the receiving sensor of this unit. If there is a problem, place the unit away from the light source.



# Setting the time

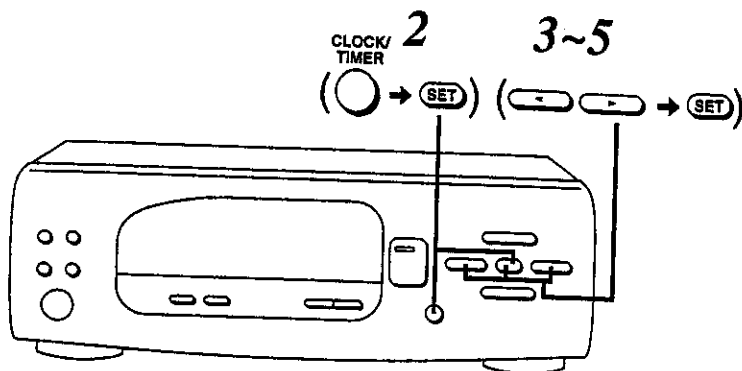
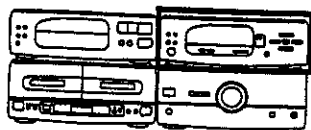

These instructions explain how to set the timer for 16:25 (4:25 p.m.) on Wednesday.

**1** **POWER**  
STANDBY ON

Switch on the power on the amplifier.

**2** **CLOCK/TIMER**

① Press **CLOCK/TIMER** to select "CLOCK".

within 7 seconds:  
② Press **SET**.

**3** ① Press **◀** or **▶** to select "WED".

② Press **SET**.

**4** ① Press **◀** or **▶** to select "16".

② Press **SET**.

**5** ① Press **◀** or **▶** to select "25".

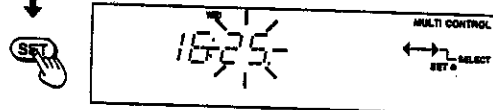

② Press **SET** to finish setting the time.

The display will return to the previous display after about 2 seconds.

When "E:" appears on the display:

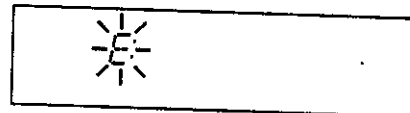

It appears when you connect the power supply cord for the first time or if there has been a power failure. If this happens, reset the time.

If the minutes setting has gone wrong:

1. Press **CLOCK/TIMER**.
2. Press **SET** 3 times.
3. Press one of **SELECT** to set the minute, and then press **SET**.

For your reference:

To display the clock again:  
Press **CLOCK/TIMER**.

The clock display will appear for about 5 seconds.

# Memory presetting

This feature allows you to set broadcast frequencies into the memory. You can then easily retrieve any of those broadcast frequencies by pressing ◀ or ▶ on the tuner/sound processor.

## Automatic memory presetting

The frequencies of the selected broadcast stations are automatically preset (in sequence from lower to higher frequencies) into the memory: "channels" 1 to 39 are available for the presetting of FM stations, "channels" 21 to 39 are available for MW stations and "channels" 31 to 39 are available for LW stations.

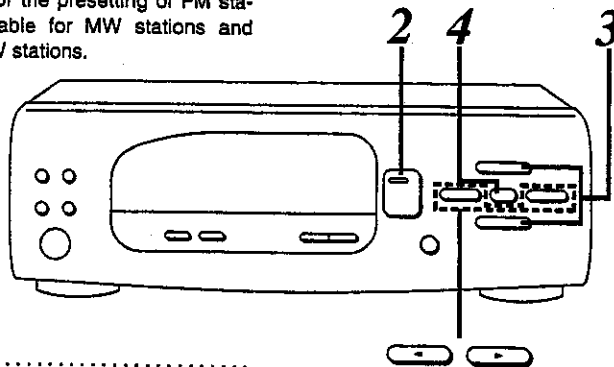
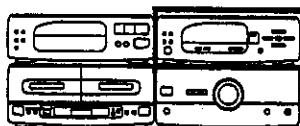

**1** Switch ON the power on the amplifier.

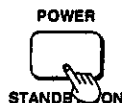

**2** Press TUNER/BAND to select FM.

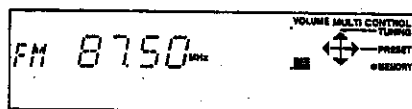

Each time you press TUNER/BAND, "FM", "MW", "LW" will appear in order.

**3** Press and hold ▲ or ▼ until the display shows the frequency from which you want to begin automatic memory presetting.



Press ▲ or ▼ momentarily to stop changing frequencies when the displayed frequency approaches the lowest frequency. Tap ▲ or ▼ a few times until the lowest frequency is reached.

**4** Press and hold SET and the automatic memory presetting will begin.



Keep SET depressed until MEMO indicator starts flashing, then release the button.

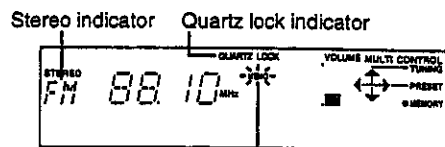

Flashes.

STEREO indicator lights when an FM stereo broadcast is being received. Quartz lock indicator lights when you precisely tune in a broadcast station. After completing the memory presetting, MEMO indicator will go out and the display will show the last preset frequency.

**To preset MW, LW broadcast frequencies into the memory:**

1. Select MW in step 2, then follow steps 3 and 4.
2. Select LW in step 2, then follow steps 3 and 4.

**To confirm the preset stations:**



Press ◀ or ▶.

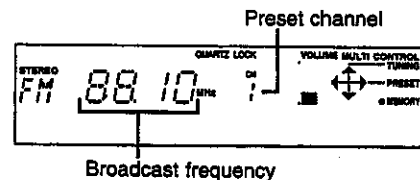

### Note

When you preset a broadcast station to a channel that has already been preset, the previous presetting will be erased. So if, for example, FM frequencies are preset from channel 1 to 39 and then MW frequencies are preset, the first MW frequency will be preset to channel 21 (thus erasing the FM presetting to channel 21), the second MW frequency will be preset to 22 (erasing FM 22), and so on.

**Preset memory contents maintenance:**

The contents of the memory will continue to be stored for approximately 2 weeks, even if the power supply cord is disconnected. Correct presetting may not be possible in cases where the broadcast waves are too strong or too weak. In such cases, carry out presetting manually. (See next page.)

## Manual memory presetting

This feature allows you to manually preset stations into any desired channel.

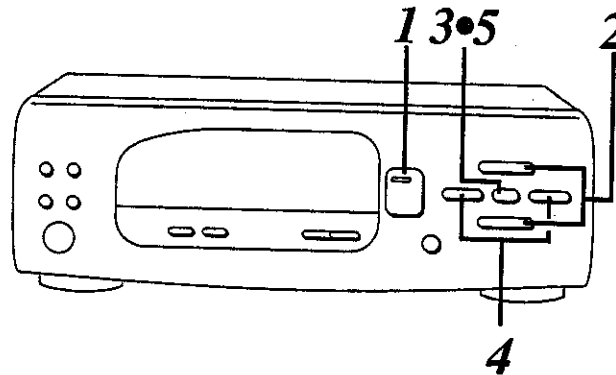
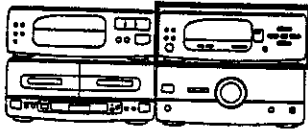

This example shows how to memorize FM 88.10 MHz into preset channel 1.

**1**  **Press TUNER/BAND to select FM or MW or LW.**  
Each time you press TUNER/BAND, "FM", "MW", "LW" will appear in order.

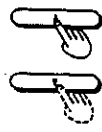
**2**  **Press ▲ or ▼ to tune in to the desired broadcast.**

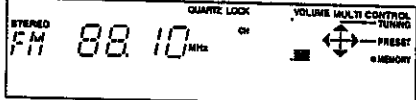

**3**  **Press SET momentarily.**

Illuminates. Flashes.

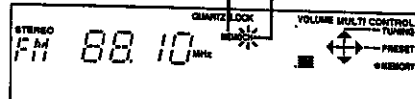

**4**  **Press ◀ or ▶ to select the desired preset channel.**

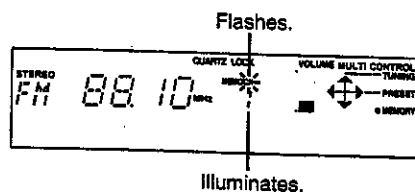

**5**  **Press SET momentarily.**  
MEMO indicator will go out.

### Automatic scanning:

Press and hold ▲ or ▼ until the displayed frequency begins to change.

- The changing of the displayed frequency will automatically stop if a broadcast station frequency is located during the tuning process.
- When there is excessive interference, the automatic scanning may not function.

To cancel the automatic scanning, press ▲ or ▼ once again.

### To preset FM stations in monaural position:

1. Select the desired frequency.
2. Press FM MODE on the remote control to show "MONO".
3. Follow the procedure 3-5 above.

### About the frequency step:

Each time you press ▲ or ▼, the frequency display will change as follows:

FM: 0.05 MHz step

MW: 9 kHz or 10 kHz step

(To change the MW allocation, see page 24.)

LW: 9 kHz step

# Listening to compact discs

## Sequential play

Sequential play refers to play beginning with the first track and continuing in order to the last track.

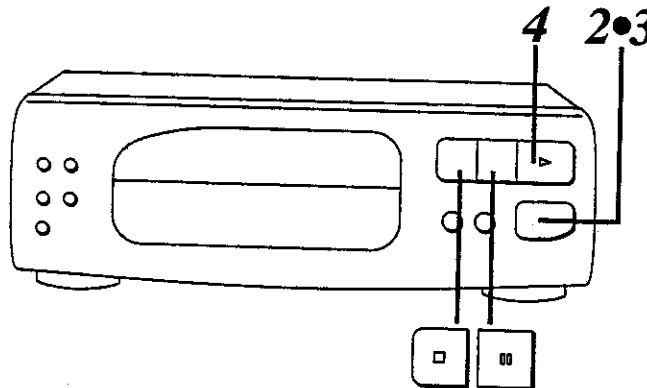
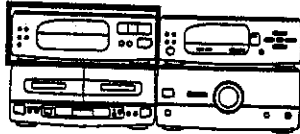

**1** **POWER**  
STANDBY ON  
Switch on the power on the amplifier.

**2** **OPEN/CLOSE**  
Press ▲ OPEN/CLOSE to open the disc tray.  
Insert the disc with label facing upward.  
Do not put your finger through the hole in the middle of the disc holder. It could get caught when the holder closes.  
Label must face upward.

**3** **OPEN/CLOSE**  
Press ▲ OPEN/CLOSE to close the disc tray.

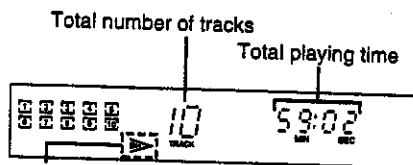

When there are 16 or more tracks on the disc, ▶ will appear.

**4** **▶**  
Press ▶.  
Disc play begins from the first track on the disc.  
Play stops automatically when the last track on the disc finishes playing.

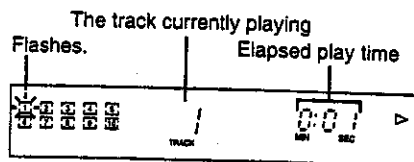

**5** **VOLUME**  
DOWN UP  
Adjust the volume level as you like on the amplifier.



**To stop the disc play:**  
Press □.



**To temporarily stop the disc play:**  
Press ■.  
▶ flashes.

To play again, press ▶.

### For your reference:

- If you press ▶ instead of ▲ OPEN/CLOSE after inserting a disc, the tray will close and play will start directly from the track 1.
- The compact disc will automatically stop when a different sound mode is selected during its operation.

### Concerning ▶ Indicator:

- While stopping: Lights in orange.
- While playing: Lights in green.

### When "no DISC" appears:

"no DISC" appears on the display if you have not put a disc on the disc tray.

### Concerning the total playing time on the display:

The total playing time displayed includes the silent sections between tracks. Hence, there will be a difference between the total playing time and the liner notes included with the disc.

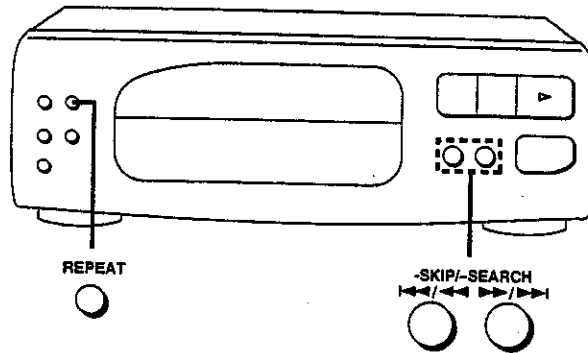
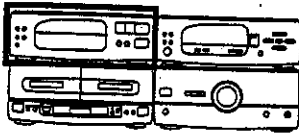

### Repeat function

This function repeats the play of all tracks.



Press REPEAT before or during play.

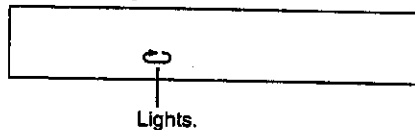

**To cancel repeat play:**  
Press REPEAT once again.

☺ indicator on the display will go out.

#### For your reference:

In program play mode, the compact disc player will repeat only the programmed tracks. You can enjoy the same track over and over by programming only one track.

### Skip function

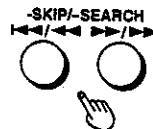

Press either  $\lll/\lll$  or  $\ggg/\ggg$  until you reach the desired track.

$\ggg/\ggg$  : To skip forward  
You can skip as many tracks as the number of time you press the button.

$\lll/\lll$  : To skip backward  
You can skip to the beginning of the track being played. If you press this button again quickly, you can skip to the beginning of the previous track.

Note that in a backward skip, the current track is included in the count.

#### For your reference:

In program play mode you can skip only the programmed tracks.

#### Note

In random play mode, you cannot skip to the previous track.

### Search function

You can rapidly forward or backward on the disc for specific sections.



While in play mode, press and hold either  $\lll/\lll$  or  $\ggg/\ggg$ . Release the button when you have reached the desired point.

$\ggg/\ggg$  : To search forward  
 $\lll/\lll$  : To search backward

#### For your reference:

During program play and random play, search will take place within the track being played.

## Direct access play

(Available only from the remote control)

Direct access allows you to start sequential play from a specific track to the last track on the disc.

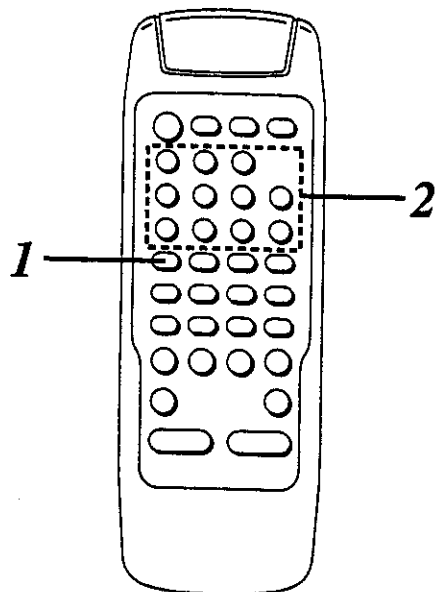

This example shows how to start the play from the 8th track.

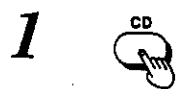

Press CD.

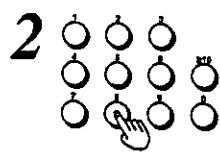

Press the numeric button to select the desired track number.

Play will start with the track you select.



**To select a two-digit track:**

Press  $\geq 10$ .

For example:

Track no. 13:  $\geq 10 \rightarrow 1 \rightarrow 3$

Track no. 20:  $\geq 10 \rightarrow 2 \rightarrow 0$

Track no. 35:  $\geq 10 \rightarrow 3 \rightarrow 5$

## Random play

The microcomputer will automatically select a sequence of tracks to be played in random order.

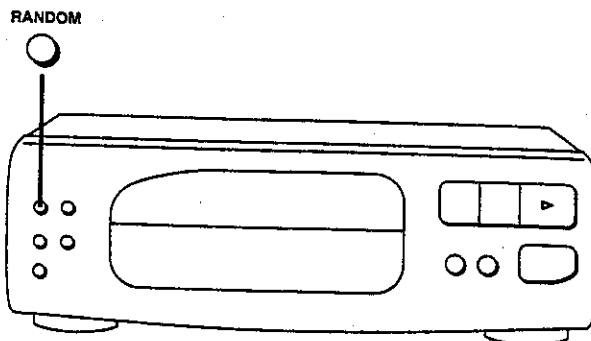
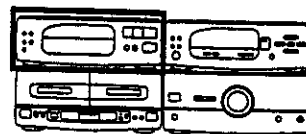

RANDOM



Press RANDOM.

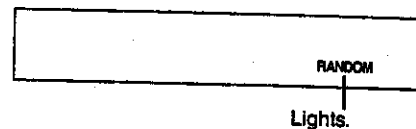

Random play will start.

RANDOM



**To cancel random play:**

Press RANDOM once again.

RANDOM indicator will go out. The compact disc player resumes the sequential play mode.

**For your reference:**

In the program play mode, the programmed tracks will be played randomly.

## Program play

(Available only from the remote control)

This function allows you to program up to 24 tracks on a disc in any order you choose.

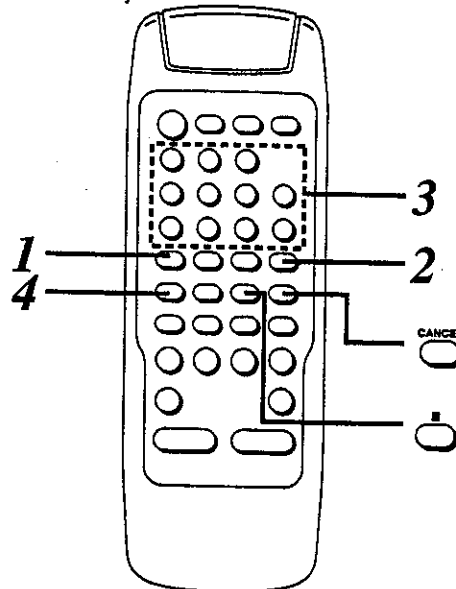

This example shows how to program tracks 3, 5 and 7, in sequence.

**1** Press CD.

**2** Press PROGRAM.

PROGRAM  
Lights.

**3** Press the numeric button to select the track you want to play in the desired sequence.

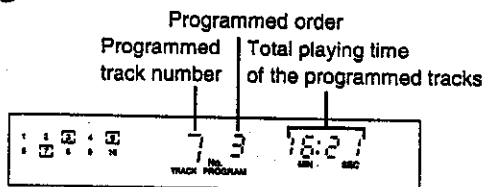

**4** Press ►.

**To cancel program play:**  
Press PROGRAM.

The compact disc player resumes sequential play mode.



### To select a two-digit track:

Press  $\geq 10$ .

For example:

Track no. 13:  $\geq 10 \rightarrow 1 \rightarrow 3$

Track no. 20:  $\geq 10 \rightarrow 2 \rightarrow 0$

Track no. 35:  $\geq 10 \rightarrow 3 \rightarrow 5$

### To add an entry:

Press the numeric button corresponding to the track to be added.

### When "FULL" appears on the display:

The number of programmed tracks is limited to 24. No further tracks can be programmed.

### When "--:--" appears on the display:

The total playing time of the programmed tracks has exceeded 99 minutes 59 seconds, or you programmed tracks numbering higher than 24. However, programming and play are still possible.

### To clear a programmed track one by one:

(Using the numeric buttons)

1. Press CANCEL.  
CANCEL indicator will light.
2. Press the numeric button of the track you want to cancel.
3. Press CANCEL.  
CANCEL indicator will go out.

(Using ◀ or ▶ buttons on the remote control)

1. Press CANCEL.  
CANCEL indicator will light.
2. Press ◀ or ▶ repeatedly until the display shows the track number you want to cancel.
3. (Within 4 seconds) Press CANCEL.  
CANCEL indicator will go out.

### To clear all tracks:

Press ■ once in the stop mode or twice in the play mode.

# Listening to radio broadcasts

## Manual tuner operation

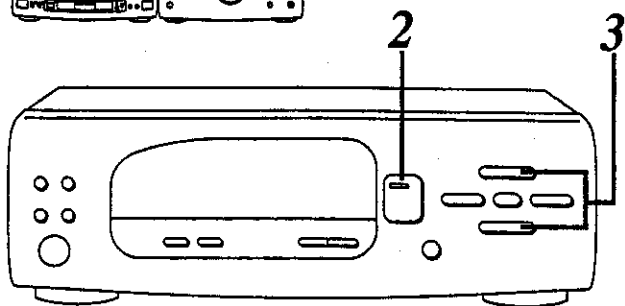
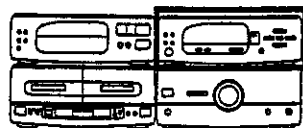

**1**  **POWER**  
Switch on the power on the amplifier.

**2**  **TUNER/BAND**  
Press TUNER/BAND to select FM or MW or LW.  
Each time you press TUNER/BAND, "FM", "MW", "LW" will be displayed in order.

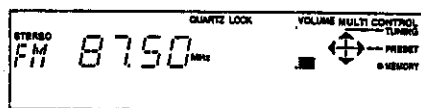

**3**  **▲ ▼**  
Press ▲ or ▼ to tune into the desired broadcast.  
The display will show the frequency which you selected.

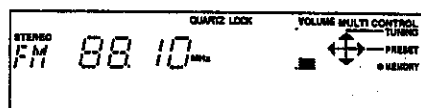

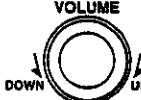
**4**  **VOLUME**  
Adjust the volume as you like on the amplifier.



**If noise is excessive in the FM mode:**  
Press FM MODE on the remote control.

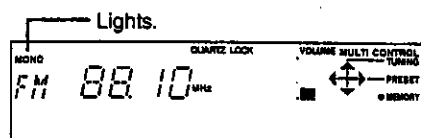

The sound will then be heard in monaural. If the broadcast signal is weak, or if there is a large amount of interference, you will get a clearer sound using FM MODE.

## Memory tuner operation

Switch on the power and be sure you've completed the steps of "Automatic memory presetting" on page 18 or "Manual memory presetting" on page 19.

This example shows how to tune in to the preset channel 1.

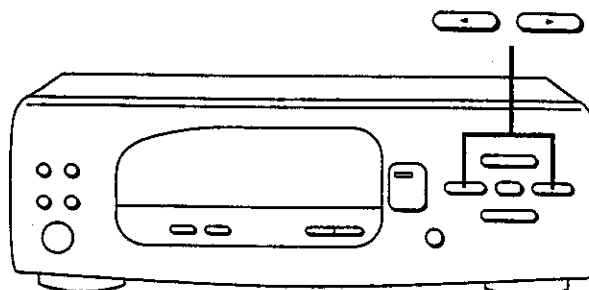
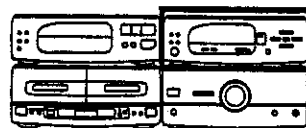

**Press ◀ or ▶ to select the desired preset channel.**  
The selected preset channel will appear on the display.

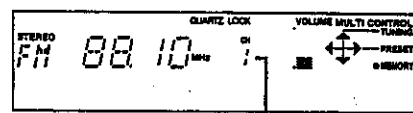

Preset channel

### MW allocation settings:

This unit comes equipped with an electronic digital tuner that divides the broadcast band into many small steps. These steps match the assignable broadcast frequencies and intervals in between. Each country allocates (assigns) broadcast bands according to their particular needs.

By adjusting the allocation, you can enable this tuner to receive MW broadcasts allocated in 10 kHz steps.

1. Press TUNER/BAND to select MW.
2. Press and hold TUNER/BAND for approximately 4 seconds.

To return to the original frequency indication, repeat steps 1 and 2.



# Listening to tapes

## Playback

You can use either deck 1 or deck 2 for tape playback.  
You can use normal, chrome and metal tapes for playback.

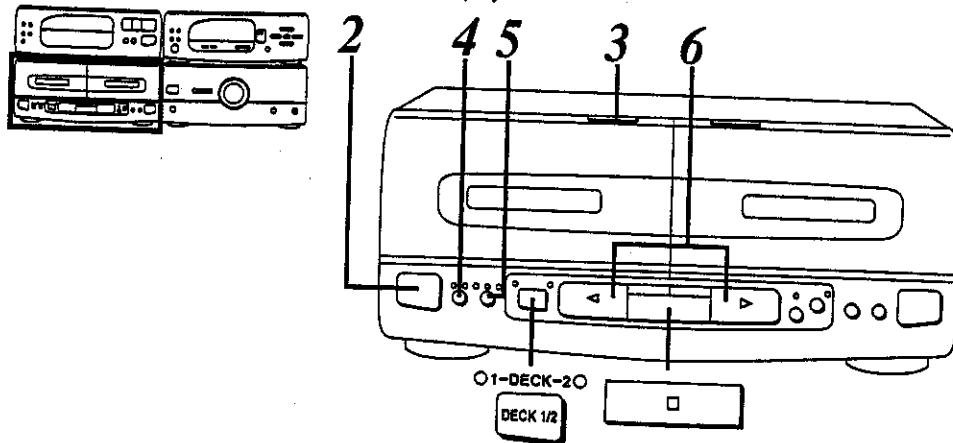

This page shows an example using deck 1.

**1** **Switch on the power on the amplifier.**

**2** **Press  $\blacktriangle$  OPEN, and then insert the cassette you wish to play.**  
Insert the cassette with the exposed tape facing down.

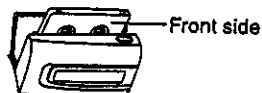

**3** **Press CLOSE on deck 1 to close the cassette holder.**

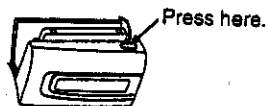

**4** **Press DOLBY NR if the cassette you want to play was recorded using the Dolby noise reduction mode.**

The Dolby NR IN indicator will light up. If the tape was not recorded using the DOLBY NR mode, press DOLBY NR to cancel the Dolby NR OUT indicator.

**5** **Press REVERSE MODE to select the reverse mode you want to use.**

Each time you press REVERSE MODE, one of the indicators will light up to show which mode you selected.

: The player plays one side only, and then the tape automatically stops.

: The player plays both sides 8 times, and then the tape automatically stops.

: The player plays both sides of the tape, then automatically stops. When you load cassettes into both decks, the deck makes a sequential playback among 2 tapes. (See page 27.)

**6** **Press  $\triangleleft$  or  $\triangleright$  to start playback.**

$\triangleright$ : The forward side (front side) will play.

$\triangleleft$ : The reverse side will play.

**7** **Adjust the volume level as you like on the amplifier.**

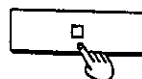

**To stop tape playback:**  
Press  $\square$ .



**To change the deck to be used:**

Press DECK 1/2 to select the deck you want to use.

DECK 1 or DECK 2 indicator will illuminate to show which deck you can operate.

**Concerning  $\triangleright$  Indicator:**

While stopping: Lights in orange.

While playing: Lights in green.

**For your reference:**

The tape will automatically stop when a different sound mode is selected during its operation.

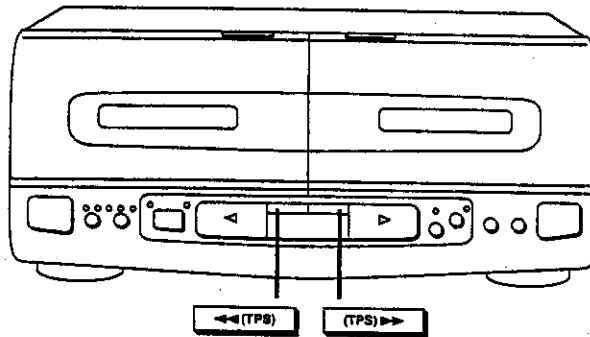
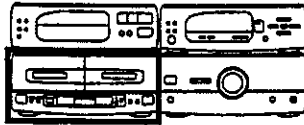

## To find the beginning of a program (TPS: tape program sensor)

Press << (TPS) or (TPS) >> while the tape is playing.

If the forward side (>) is playing:

**(TPS) >>** : The tape will play from the beginning of the next tune.

**<< (TPS)** : The tape will rewind to the beginning of the present tune. Then the tune will play again.

If the reverse side (<) of the tape is playing:  
The reverse operation should take place.

### Note

TPS (Tape Program Sensor) is the function that searches for the silent passage in a tape program. So, it may sometimes fail to operate correctly in the following situations:

- When there is no blank space between tape programs (for example, when you are playing a tape recorded from a microphone)
- When the interval between programs (blank space) is less than 4 seconds
- When there is a particular low-level passage or silent passage in the middle of a program (For example, classical music)
- When the program is less than 10 seconds, or when it is less than 10 seconds from the beginning of the program to the beginning of the next program
- When a tape has been recorded with fade-ins (the function that increases the volume level gradually at the beginning of a program) and fade-outs (the function that decreases the volume level gradually at the end of a program)

### For your reference:

Each decks' play direction is stored in the system's memory. So the play direction may change when you press DECK 1/2.

## To fast forward or rewind the tape

Press << (TPS) or (TPS) >> while the tape is in the stop mode.

If the forward side (>) of the tape is playing:

**(TPS) >>** : The tape will be fast forwarded.

**<< (TPS)** : The tape will be rewound.

If the reverse side (<) of the tape is playing:  
The reverse operation will take place.

### High-speed rewind/fast-forward:

On this unit, if there is less tape on the take-up side than on the supply side (refer to the illustration below) at the time that << or >> is pressed, the speed of the rewind/fast-forward operation will automatically be increased for approximately 1.5 times the normal speed. This function makes it possible to wind the tape faster when there is a large amount of tape to be wound.

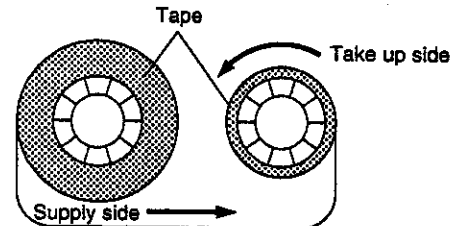

### Notes

- When there is more tape on the take up side than on the supply side, the tape will be wound at the normal speed.
- If high speed winding is begun from a state in which the tape is partly wound, such as that shown in the illustration above (for example, when the ratio of tape between the two sides is 1:3), high speed winding will continue until the ratio between the two sides reaches 3:1, and then the remaining winding will be done at the normal speed.

### For your reference:

You can fast forward or rewind the tape while you are playing or recording a tape in another deck. Press DECK 1/2 to switch to the non playing deck, and then press << or >>.

After above operation, be sure to press DECK 1/2 to select the deck in which you are playing a tape.

## Sequential playback among 2 tapes

You can listen to two tapes consecutively with the procedure below.

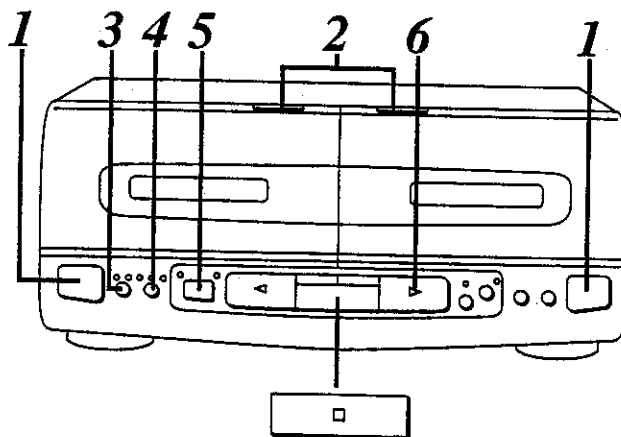
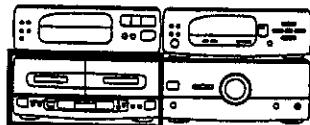

**1** **Load cassettes in decks 1 and 2.**  
Load with the side that you wish to listen to first facing you in deck 1.

**2** **Press CLOSE to close each deck's cassette holder.**

**3** **Press DOLBY NR if the cassette you want to play was recorded with Dolby noise reduction mode.**  
The DOLBY NR IN indicator will light up. If the tape was not recorded using Dolby NR mode, press DOLBY NR and the DOLBY NR OUT indicator will light up.

**4** **Press REVERSE MODE to set to the ∞ mode.**

**5** **Press DECK 1/2 to select deck 1.**  
The DECK 1 indicator lights to show you can select deck 1.

**6** **Press > to start playback.**  
Two tapes will play back as follows:

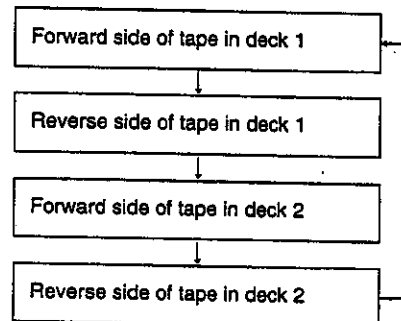

After repeating above operation 8 times, the tape will automatically stop.



**To stop sequential tape play:**  
Press .

### For your reference:

- You cannot select Dolby NR for deck 1 and deck 2 respectively.
- We recommend that you use cassette of the same type (Dolby noise reduction) in both decks.
- You can also start playback from a position other than the forward side of the tape in deck 1.

### About priority of the deck:

When you load cassettes in both decks, DECK 1 or 2 indicator will light to show which deck you loaded last.  
When you switch on the power, DECK 1 indicator will light.

# Convenient functions

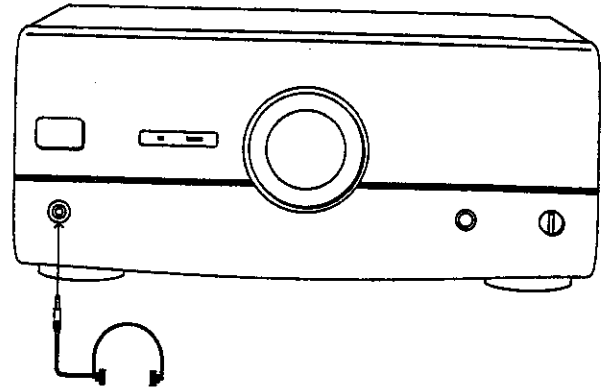
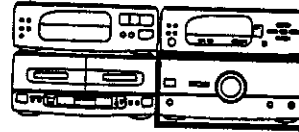
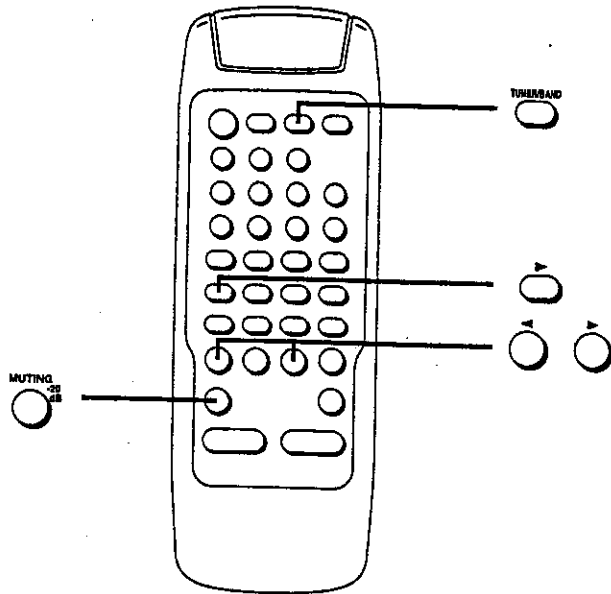

## Easy play

From the power standby condition, you can start play directly.

### Listening to compact discs



Press **▶**.  
The play will start from the first track.

### Listening to radio broadcasts



Press **TUNER/BAND**.  
You can receive the station last tuned in when the power was switched to standby condition.

### Listening to tapes



Press **◀ or ▶**.  
The playback will automatically start corresponding to the direction (◀ or ▶) you select.  
When a tape has been loaded in both decks, the deck 1 will play.

### About fade-in start in direct play:

When you set the volume level under -60 dB last, the easy play will start with volume increasing to -60 dB gradually (fade-in). When you set the volume level over -58 dB last, the play will start with volume increasing gradually up to the volume level you set last.

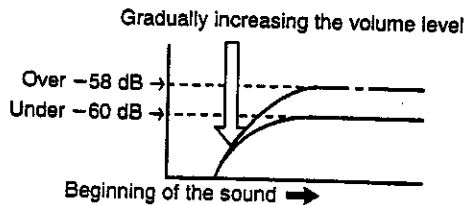

## To mute the volume



Press **MUTEING -20 dB** on the remote control.



Lights.

This feature is convenient when you have a telephone call, etc.  
To cancel the muted state, press **MUTEING -20 dB** once again.  
To cancel from the pre-amplifier, reduce the volume level to the minimum position (-∞ dB) and then reset to the desired volume.

## To use headphones

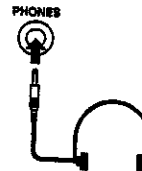

Connect the headphones to the headphones jack.

Before connecting, reduce the volume level.

Avoid listening for prolonged periods of time to prevent hearing damage.

Plug type: Stereo mini

# Making a recording from radio broadcasts

You can use normal, chrome and metal tapes for recording. The deck automatically identifies the kind of tape loaded, and sets the bias (for recording) and equalization accordingly.

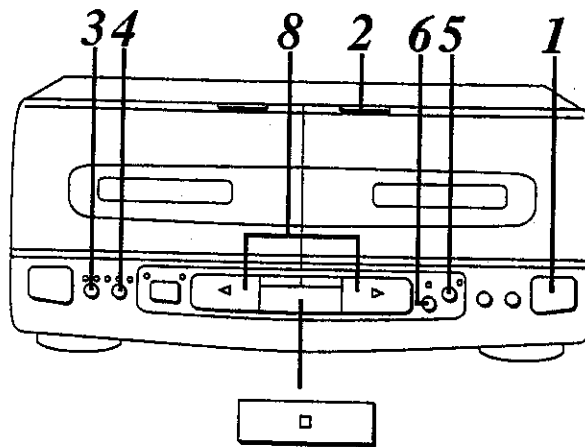
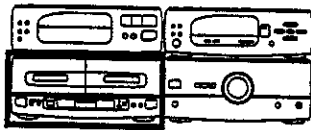

You cannot record on the leader tape (the first few revolutions) so take up the leader tape in advance. (See page 30.)

When the CCRT function is activated, the test signal for adjustment will be recorded on the tape, so the previous recording will be automatically erased. You can record without using the CCRT function.

**1** Press **▲ OPEN** on deck 2 to load a cassette.



**2** Press **CLOSE** on deck 2 to close the cassette holder.



**3** When making a recording using Dolby NR recording, press **DOLBY NR** so that the Dolby NR IN indicator lights.



**4** Press **REVERSE MODE** to select the reverse mode you want to use.

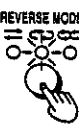

- ☐ : One side will record, and then the tape will stop automatically at the tape end.
- ☐☐ : Both sides will record (forward side→reverse side), and then the tape will stop automatically at the tape end.

**5** Press **CCRT** to activate the CCRT (Computer Control Record Tuning—see page 30) function.

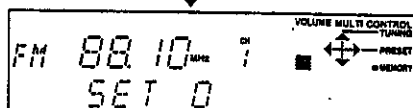
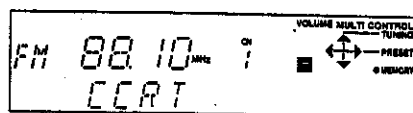

**6** Press **REC PAUSE** to put the cassette deck into the recording standby mode; then select the desired sound source. REC PAUSE indicator lights.



**7** Press **TUNER/BAND**, and then **◀** or **▶** on the tuner/sound processor to tune in to the desired station.



**8** Press **◀** or **▶** to start recording.  
 ▶: When recording on either the forward side or both sides  
 ◀: When recording only the reverse side

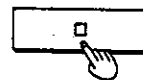
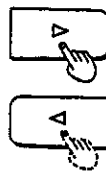

**To stop recording:**  
Press **☐**.

**To cut an unnecessary part while recording:**

1. Press REC PAUSE. The cassette deck will go into the recording standby state.
2. To resume recording, press **◀** or **▶** corresponding to the direction in which recording is taking place.

## Making a recording from the radio broadcasts

### CCRT recording function:

CCRT (Computer Control Record Tuning) is the function which identifies the quality of the tape (concerning bias, level, equalizer) automatically and sets the most desirable recording condition. While the CCRT setting is activated, the CCRT indicator flashes. After the setting has completed, CCRT indicator stops flashing. The CCRT setting will remain in the system's memory even after the power is switched to the standby mode.

#### Notes

- Do not press INT or EXT while the CCRT setting.
- Do not insert or remove the cassette tape after the CCRT setting has completed. It cancels the CCRT setting.
- The CCRT setting may not be possible with the old cassette tape or at around the end of the cassette tape. (The CCRT indicator starts to flash in a high speed.) In this case, press  and record without using the CCRT function. (The CCRT indicator goes out.)

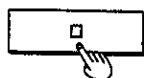

To cancel the CCRT setting on the way:  
Press .



To cancel the CCRT after the CCRT setting has completed:  
Press CCRT.

### To erase a recorded sound (Deck 2):

When you make a new recording on a previously recorded tape, the new recording will automatically erase what was previously recorded. To erase a recorded sound without making a new recording, perform the following steps:

- 1) Disconnect the microphone if it was connected.
- 2) Press INT to select the tape mode.
- 3) Insert the recorded tape into the cassette holder of deck 2.
- 4) Press DOLBY NR so that Dolby NR OUT indicator lights up.
- 5) Select the desired reverse mode.
- 6) Press REC PAUSE.
- 7) Press the playback button (< or >) corresponding to the side to be erased.

### To take up the leader tape

The leader tape is the first few revolutions that you cannot record on.

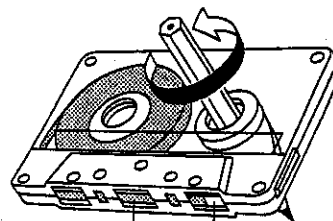

Magnetic tape (recordings can be made)

Leader tape (no recordings can be made)

### To record with desired tone quality

To record with the desired tone quality, follow the procedure below.

1. Select the desired tone quality. (See pages 38-40).
2. Follow the procedure of "Making a recording from the radio broadcasts" on page 29.

#### Note

When playing back such recordings, press ON/FLAT on the tuner/sound processor to set to "FLAT".

### To record without any tonal effect

Press ON/FLAT on the tuner/sound processor to set to "FLAT". (See page 38.)

### About Dolby Noise Reduction system

Using Dolby NR reduces tape hiss in the high-frequency range. It boosts the level of the high-frequency during recording, and lowers it by the same amount during playback, simultaneously reducing high-frequency interference incurred during the recording process.

Interference is reduced to about 1/3. Use this type when playing a tape in the Dolby NR mode.

Dolby noise reduction manufactured under license from Dolby Laboratories Licensing Corporation. "DOLBY" and the double-D symbol  are trademarks of Dolby Laboratories Licensing Corporation.

Your attention is drawn to the fact that recording pre-recorded tapes or discs on other published or broadcast material may infringe copyright laws.

# Recording from compact discs

There are 2 ways to record from compact discs, one-touch editing and synchro-recording. See below for the information.

Use this procedure	Tape allotment
--------------------	----------------

## One-touch editing

The system calculate the length of the tape used, and safeguards against a break in the continuity of sound when the recording changes from one side of the tape to the other.

### Editing of all tracks in their original sequence (ALBUM)

If the system determines it is possible to record one more track on side A, the cassette deck rewinds the tape side A and the first track assigned on the tape side B will be recorded on the tape side A. Up to 24 tracks can be edited.

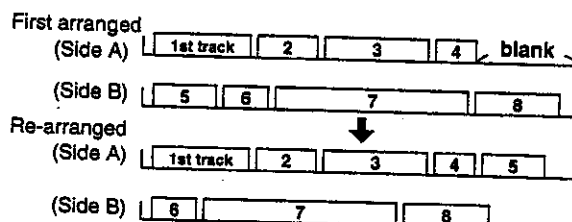

### Allotting tracks to the tape without wasting tape space (J. FIT)

If the amount of blank space is too great, the cassette deck rewind the tape end and the compact disc player selects a track which is the most appropriate fit for the end of tape side A. Upt to 24 tracks can be edited.

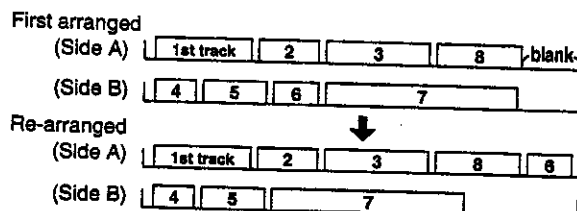

### Closing up the tape-end unrecorded sections (LAST FADE)

At the end of side A of the tape, a track that cannot be recorded completely will be faded out, and then rcorred from the begining of side "B". During recording, silent gaps of approximately 4 seconds are automatically inserted between tracks (auto space function). You can edit as many tracks as you like using this mode.

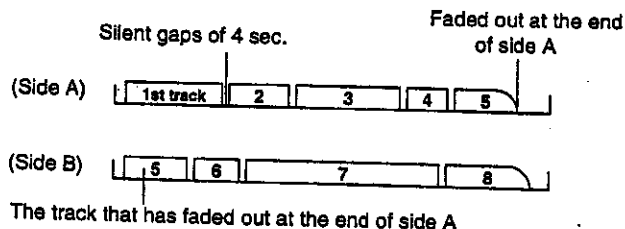

### Linking up several discs (LINK)

After the edit-recording of a loaded disc has finished, you can subsequently edit-record another disc on the remaining blank portion of the tape. This function is convenient when recording from 3" (8 cm) compact discs successively.

This example shows when you use J.FIT edit.

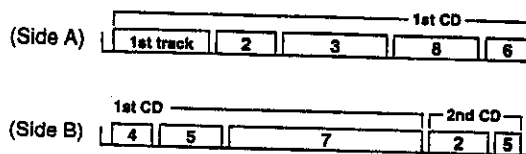

## Synchro-recording

The system records tracks in the original sequene without calculating the tape length. You can record as many tracks as you like using this mode.

When you want to record on the remaining portion of the pre-recorded tape, use the synchro-recording.

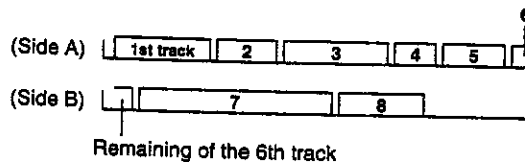

## One-touch editing preparation

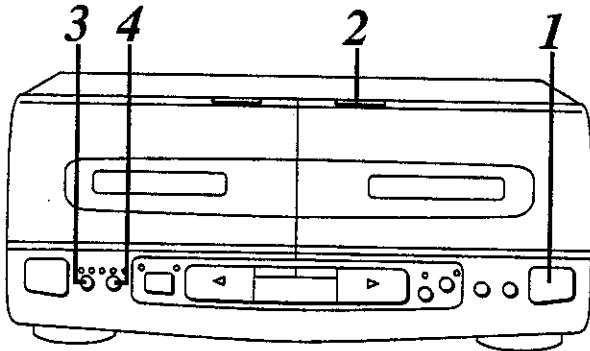
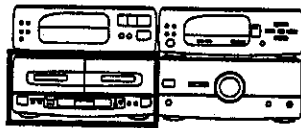

You can use normal, chrome, and metal tapes for recording.

**1** Press **▲ OPEN** to load a cassette in deck 2.



When the edit-record will start, the cassette tape will automatically rewind the tape back to the beginning where the recording can be made. So you don't have to rewind the tape in advance.

**2** Press **CLOSE** on deck 2 to close the cassette holder.



**3** Press **DOLBY NR** so that the **DOLBY NR IN** indicator lights.



**4** Press **REVERSE MODE** to select "↔" for automatic two-sided recording.

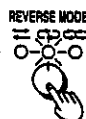

**5** Press **▲ OPEN/CLOSE** on the compact disc player to load a disc, and then press it again.



## To start one-touch editing

There are 3 types of one-touch editing. Be sure to finish the procedure of "One-touch editing preparation" on the left.

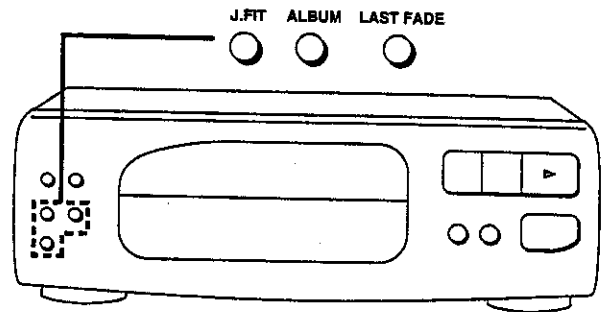
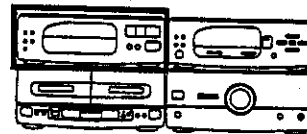

### Editing of all tracks in their original sequence (ALBUM)



Press **ALBUM**.

The tracks assigned on tape side A

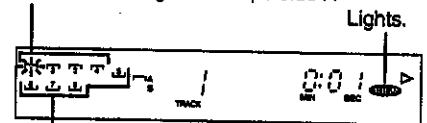

The tracks assigned on tape side B

The recording will start after the system completes the "One-touch editing operation" on page 33.

#### Notes

- Use a tape of under 99 minutes.
- You cannot edit-record tracks numbering higher than 24.

### Allotting tracks to the tape without wasting tape space (J.FIT)



Press **J.FIT**.

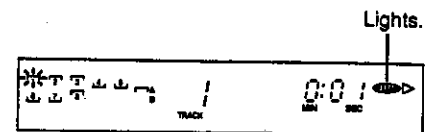

The recording will start after the system completes the "One-touch editing operation" on page 33.

#### Notes

- Use a tape of under 99 minutes.
- You cannot edit-record tracks numbering higher than 24.



## Closing up the tape-end unrecorded sections (LAST FADE)

LAST FADE



Press LAST FADE.

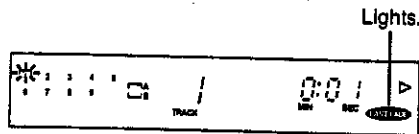

The recording will start after the system completes steps 2–3 of "One-touch operation" below.

Use this editing mode when you record more than 24 tracks.

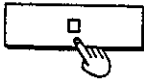

**To cancel one-touch editing:**

Press  on the cassette deck.

The compact disc player also stops.

### One-touch editing operation:

1. The cassette deck will fast-forward and rewind to measure its length. At the same time, CCRT function will be activated. (See page 30.)
2. The cassette deck will automatically advance the tape beyond the leader tape, and then stop.
3. The compact disc player automatically scans for the peak (highest) level of the entire disc (**Automatic Tape Level Setting—ATLS**), then recording will start. ATLS is the function which scans (fast search) for the peak (highest) level of the disc, and sets the appropriate recording level. When ATLS is activated, no sound will be heard.

It takes about 70 seconds to complete ATLS for a compact disc of 60 minutes.

### When there are tracks allotted on tape side B:

After recording tracks allotted on tape side A, the cassette deck will continue recording making the blank portion on tape side A to measure the tape length.

### To record with desired tone quality:

Select the desired tone quality (see pages 38–40), and start editing. To play back such recordings, press ON/FLAT on the tuner/sound processor to set to FLAT.

### To specify the tracks to be edited:

You can specify the tracks to be edited using the program play procedure. (See page 23.)

After completing step 5 on the previous page:

1. Press PROGRAM on the remote control, and then specify the tracks to be recorded in the desired sequence.
2. Press one of the one-touch editing buttons (ALBUM, J.FIT, LAST FADE) to start editing.

### Note

You can program up to 24 tracks (and also tracks numbering lower than 24).

"FULL" appears on the display if you try to program more than 24 tracks.

### After the edit recording has finished:

The deck automatically enters the recording standby mode. When "LINK" indicator flashes, it means you can edit tracks from same or another disc in succession. (See page 34.)

### To finish recording:

Press  on the compact disc player and "LINK" indicator goes off.

## Linking up several discs (LINK)

You can link up another disc when LINK indicator flashes after editing a compact disc.

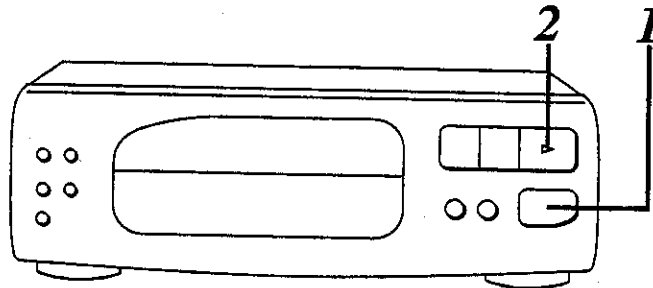
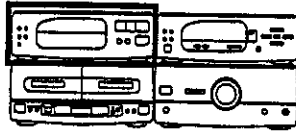

1



Press **▲ OPEN/CLOSE** to replace the disc with another disc, and then press it again.

The time remaining on tape

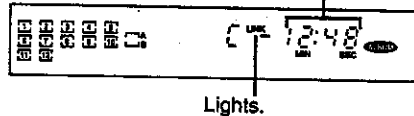

2



Press **▷** to start recording.

The recording will start with the same editing mode of the first disc. The system will assign tracks to be recorded on the remainder of the tape and display the results.

Tracks to be recorded on tape side B



The recording will start after the system completes the ATLS (see "One-touch editing operation" on page 33) setting.

3

Repeat steps 1-2 to record more discs.

### To specify the tracks to be edited:

1. Replace the CD.
2. Press PROGRAM on the remote control, and specify the track number you want to record using the program play procedure.
3. Press ▷ to start recording.

### To record from the same disc in succession:

1. Press PROGRAM on the remote control, and specify the track number you want to record using the program play procedure.
2. Press ▷ to start recording.

### Notes

- When you record the first compact disc using LAST FADE, tracks to be recorded will not be displayed. However, it is possible to record from another disc.
- When the display shows "0:00", you cannot record from another disc. Press □ to cancel the edit mode.
- If the time remaining on the tape is shorter than the length of the tracks to be recorded, you cannot record the tracks. Replace the disc with the tracks shorter than the time remaining on the tape or press □ to cancel the edit mode.

## Synchro recording

You can use normal, chrome, and metal tapes for recording.

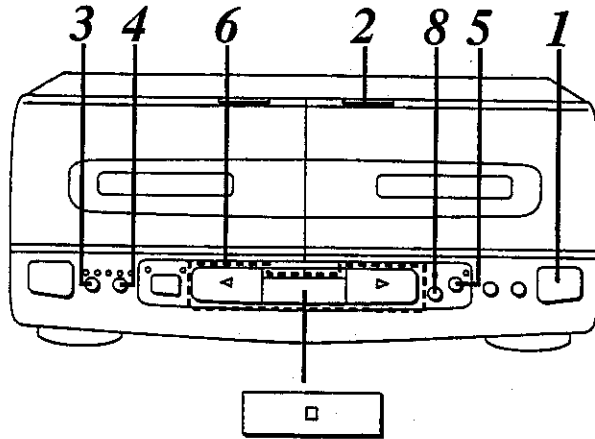
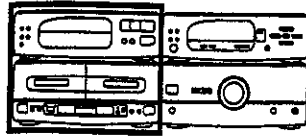



Check that the tape's erasure prevention tabs (see page 53) are intact, and then insert the cassette into deck 2. The leader tape must be wound on beforehand. (See page 30.)

**1**  Press **▲ OPEN** to load a cassette in deck 2.

**2**  Press **CLOSE** on deck 2 to close the cassette holder.

**3**  Press **DOLBY NR** so that the **DOLBY NR IN** indicator lights.



**4**  Press **REVERSE MODE** to select the reverse mode you want to use.

 : One side will record, and then the tape will stop automatically.

 : Both sides will record (forward side/reverse side), and then the tape will stop automatically.

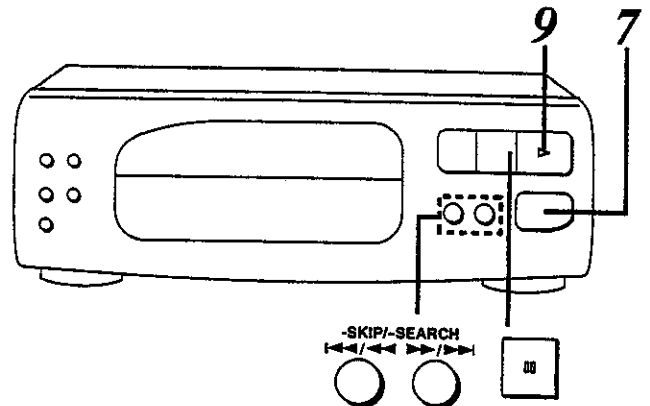
**5**  Press **CCRT** to activate the **CCRT** function. You can record without using the **CCRT** function.



**6**  or  Set the **tape travel direction**. To change the tape travel direction, first press **<** or **>** on the cassette deck, then .

**7**  Press **▲ OPEN/CLOSE** to load a disc and then press it again.

**8**  Press **REC PAUSE**. The cassette deck will enter the recording standby state.

**9**  Press **>** on the compact disc player to start recording. The recording will automatically start corresponding to the tape travel direction indicator.



**To stop recording:**  
Press  on the cassette deck.

### After the compact disc play finishes:

The cassette deck will create a non-recorded passage of about 4 seconds, and then go into the recording standby state.

### When you want to cut an unnecessary track while recording:

Before an unnecessary track play will start:



1. Press . The cassette deck will create a non-recorded passage of about 4 seconds, and then go into the recording standby state.
2. Press  or  to skip to the desired track.
3. Press **>** on the compact disc player to resume recording.

# Tape-to-tape recording

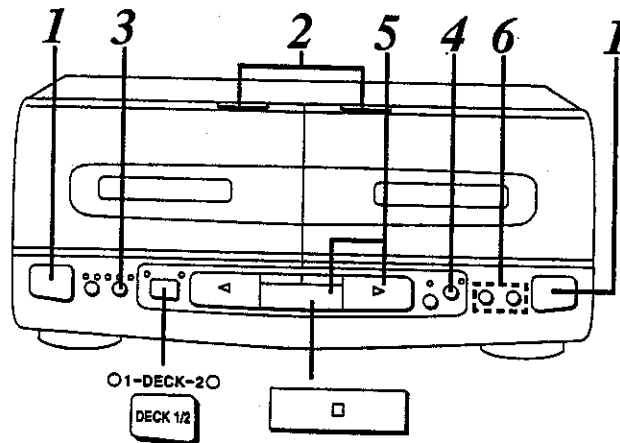
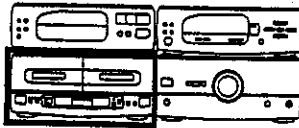



You can use normal, chrome and metal tapes for recording. The recording level and the noise reduction effect of the original (playback) tape will be recorded on the new tape just as they were in the original recording.





Check that the tape's erasure prevention tabs (see page 53) are intact, and then insert the cassette into deck 2. The leader tape must be wound on beforehand. (See page 30.)



**1**   **Load cassettes.**  
For playback: Into deck 1  
For recording: Into deck 2  
Insert both cassette with the starting side facing in front.

**2**  **Press CLOSE to close each deck's cassette holder.**

**3**  **Select the desired reverse mode.**  
: Single-sided recording  
: Two-sided recording (forward side → reverse side)  
 In case the tape length loaded in deck 2 is longer than a tape in deck 1, deck 1 repeats the playback until deck 2 completes the two-sided recording. (8 times max.)  
: Two-sided recording (forward side → reverse side)

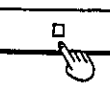
**4**  **Press CCRT to activate the CCRT function. (See page 30.)**  
You can record without using the CCRT function.

**5**   **Set the tape direction to "▷" of deck 1 and deck 2.**  
Press DECK 1/2 and confirm both deck's tape direction are "▷".  
To change the tape direction, first press ▷, and then □.  
To record on the reverse side, set deck 2 to "◁" tape direction. (In this case, be sure to rewind the tape to the beginning of the reverse side.)

**6**   **ONE TOUCH TAPE EDIT**  
NORMAL HIGH

**Press one of ONE TOUCH TAPE EDIT (NORMAL or HIGH) to start recording with the desired editing speed.**

**NORMAL:** When you wish to monitor the sound while recording

**HIGH:** When you wish to record at high speed (about 2 times normal speed)

While recording, both DECK 1 and DECK 2 indicators light. Tape direction indicator shows the tape direction of deck 2.

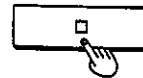

**To stop recording:**  
Press □.  
Both decks will stop.

**To record another tape on the remaining blank portion of the tape:**

Replace the tape for playback in deck 1, and then press NORMAL or HIGH.

**To enjoy another source while recording:**

Press ▷ on the compact disc player or TUNER/BAND on the tuner/sound processor, and start the sound source.

You can change the volume level and tone quality without affecting the recording.

**For your reference:**

For optimum results, use an editing tape of the same or higher quality than the playback tape.

## Notes

- Some TV sets generate noise that could be recorded during tape-to-tape recording. To prevent the possibility of this, do not use this system close to a TV set.
- Do not press CD edit recording buttons (J.FIT, ALBUM, LAST FADE) while tape-to-tape recording is in progress. It changes the tape-to-tape recording to the CD edit recording mode.

# Changing the tone

---

## *About equalization curves (EQ)*

---

Use this sound mode when you want to change the tone according to the type of music.

There are 5 equalization curves preprogrammed to this system. (See page 38.)

---

## *About simulated listening environments (SPACE)*

---

Use this sound mode when you want to create the "live" performance sound.

There are 3 simulated listening environments preprogrammed to this system. (See page 39.)

You can adjust equalization curves and simulated listening environment as you like, to store them as "USER" mode. (See page 40.)

## To retrieve the preprogrammed equalization curves (EQ mode)

5 types of equalization curves preprogrammed to this system.

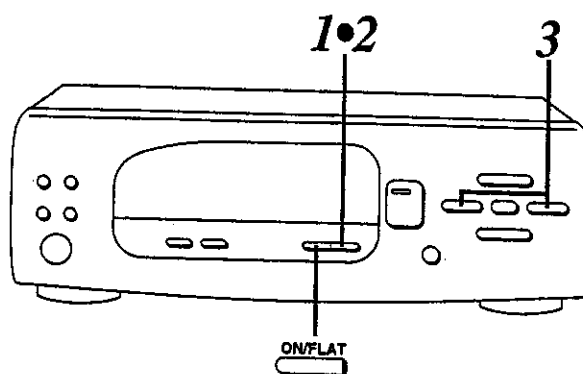
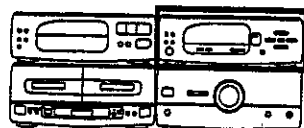

**1**



Press **MODE** to select EQ mode.

Each time you press MODE, EQ and SPACE mode will be alternately switched.

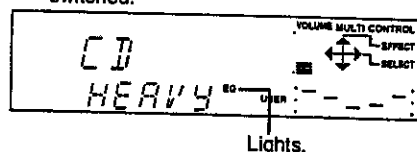

Lights.

The display shows one of the EQ mode (HEAVY, CLEAR, SOFT, CAR, HP ST) which is previously retrieved.

**2**



Press and hold **MODE** to select PRESET mode.

Each time you press and hold MODE, PRESET and USER mode will be alternately switched.

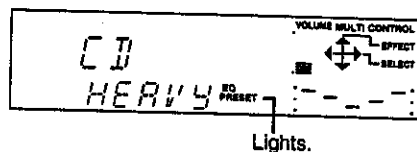

Lights.

**3**



Press **◀** or **▶** to select the desired equalization curves.

Each press **▶** advances the equalization curve setting as follows.

HEAVY → CLEAR → SOFT

↑ ↓

HP ST ← → CAR

Pressing **◀** advances the equalization setting conversely.

**2. CLEAR**

Use to clarify the treble range of jazz, etc.

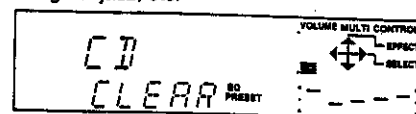

**3. SOFT**

Use to listen to background music, etc.



**4. CAR (CAR STEREO)**

Use to record a tape for playback using the car audio system (Car stereo).

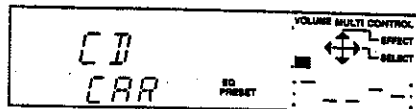

**5. HP ST (HEADPHONES STEREO)**

Use to record a tape for playback using the stereo cassette player (Headphones Stereo).

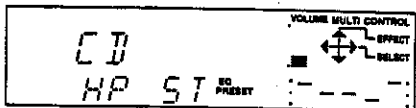

**To cancel the EQ mode:**

Press ON/FLAT to select FLAT.

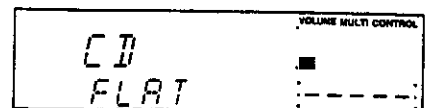

**For your reference:**

You can record with desired equalization curves. To playback such recordings, press ON/FLAT to select FLAT.

**When listening to the radio broadcast:**

After pressing MODE (on steps 1 and 2), proceed to the next step within 10 seconds. If not, the display will return to the tuning/preset mode. In this case, press MODE twice, and proceed to the next step.

**Note**

During CD edit recording, you cannot alter the EQ mode.

### About the pre-programmed equalization curves

**1. HEAVY**

Use to add "punch" to rock and other music.

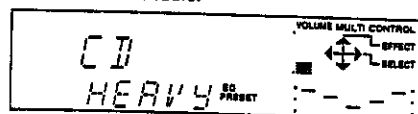

## To retrieve the preprogrammed simulated listening environments (SPACE mode)

3 types of simulated listening environments preprogrammed to this system.

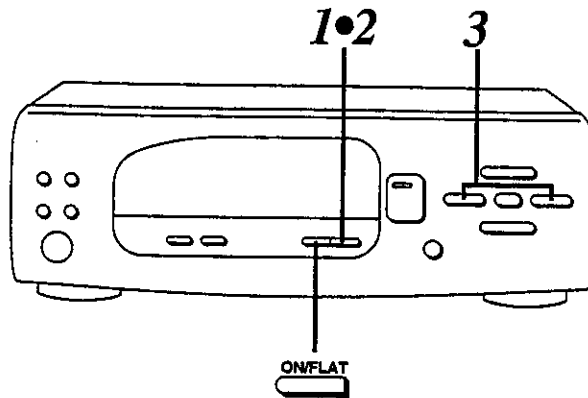
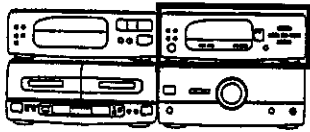

**1 Press MODE to select SPACE mode.**

Each time you press MODE, EQ and SPACE mode will be alternately switched.

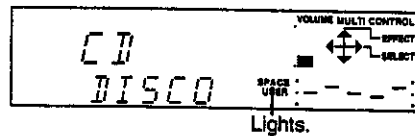

The display shows one of the SPACE mode (DISCO, LIVE, HALL) which is previously retrieved.



**2 Press and hold MODE to select PRESET mode.**

Each time you press and hold MODE, PRESET and USER mode will be alternately switched.



**3 Press ◀ or ▶ to select the desired simulated listening environments.**

Each press of ▶ SELECT advances the simulated listening environment setting as follows.



Pressing ◀ advances the equalization setting conversely.

### 2. LIVE

Use primarily for vocal pieces to add gloss to the vocals.



### 3. HALL

Use to impart a deep bass and spread which will make you feel as if you were in a large concert hall.



### To cancel the SPACE mode:

Press ON/FLAT to select FLAT.



### For your reference:

You can record with desired simulated listening environments. To playback such recordings, press ON/FLAT to select FLAT.

### When listening to the radio broadcast:

After pressing MODE (on steps 1 and 2), proceed to the next step within 10 seconds. If not, the display will return to the tuning/preset mode. In this case, press MODE twice, and proceed to the next step.

### Note

During CD edit recording, you cannot alter the SPACE mode.

## About the pre-programmed simulated listening environments

### 1. DISCO

Use to create powerful bass sounds found in discos.



## To adjust EQ and SPACE ("USER" mode)

You can adjust equalization curves and simulated listening environments as you like, and store them as the USER mode in its memory.

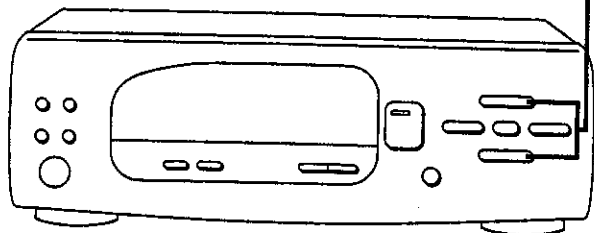
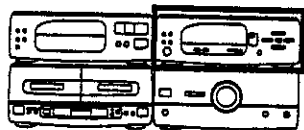

**1**

Select the equalization curve or simulated listening environment of which you want to adjust the tone.

(See pages 38–39.)

**2**



Press ▲ or ▼ to adjust the equalization curve or simulated listening environment.

▲ : To increase the effect

▼ : To decrease the effect

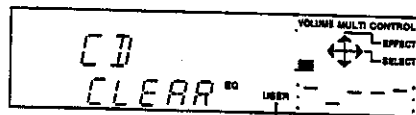

Lights.

Once you have made the adjustment, the system automatically stores the simulated listening environment or equalization curve as the USER mode in its memory.

### To retrieve the USER mode:

1. Select the desired equalization curve or simulated listening environment.
2. Press and hold MODE to select USER.

### For your reference:

Any adjustment will not affect the PRESET modes (equalization curves or simulated listening environments preprogrammed to this system).

USER modes will continue to be stored for approximately 2 weeks, even if the power supply cord is disconnected.

## To listen with augmented bass (V.BASS)

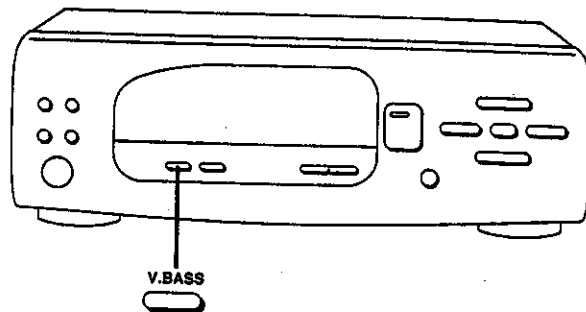
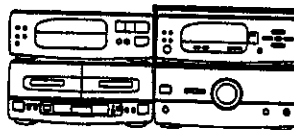

Press V.BASS to ON.

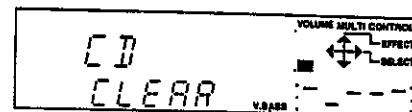

V.BASS indicator lights.



To cancel the V.BASS effect:  
Press V.BASS once again.

### Notes

- You cannot make a recording with the V.BASS effect. While recording, V.BASS mode cannot be activated.
- V.BASS indicator goes out while recording, and lights when recording finishes.



# Using the timer

Make sure that you have completed "Setting the time" on page 17.

## About the types of timer operation

There are 3 types of timer operation.  
You can use below timer modes in conjunction.  
See page 47 for details.

### Play timer (See pages 42–43):

Select this timer when you want to use the timer as an alarm clock.  
You can wake up with listening to music (CD, tuner, tape) at a desired volume level and time.

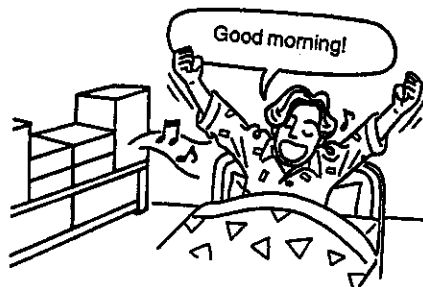

### Record timer (See pages 44–45):

Select this timer when you want to use the timer to record a midnight program or while you are out. The system will record a desired radio broadcasts at a desired time.



The recording will be made while you are out.

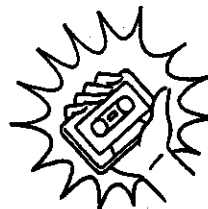

### Sleep timer (See page 46):

Select this timer when you want to use the timer to switch off the music automatically as you can fall asleep while listening. The system will go into power standby condition after assigned time has passed.

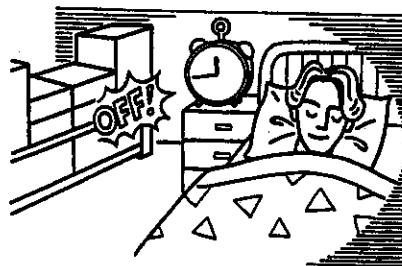
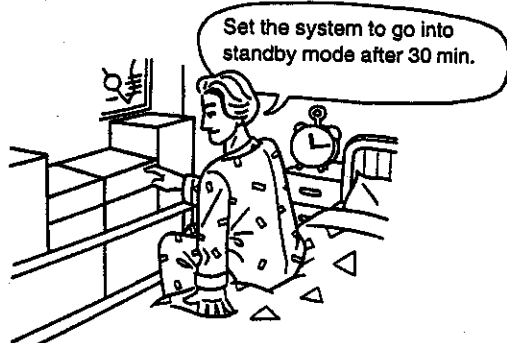

Setting the play timer

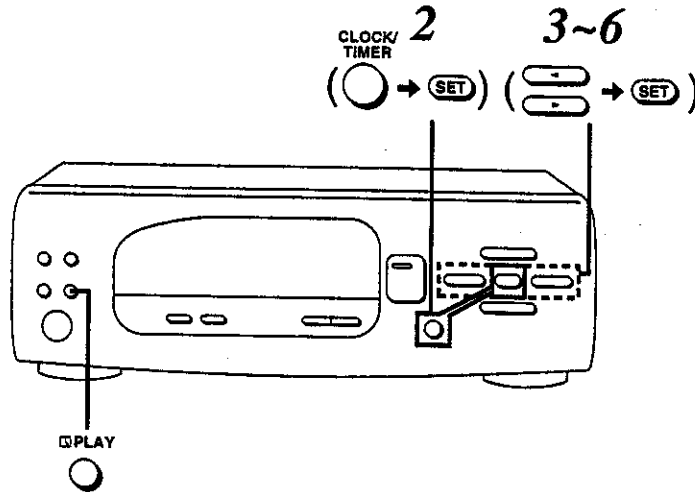
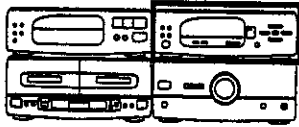

The following example shows how to set the play timer for; playing a CD at -46 dB everyday from Monday through Friday 6:30 to 7:40.

**1** **Adjust the volume level for the timer play on the amplifier.**

**2** **① Press CLOCK/TIMER three times to select PLAY.**

**② Press SET.**

Within 10 seconds:

**3** **① Press or to select the day.**

**② Press SET.**

**4** **(“ON” time setting)**  
**① Press or to select the hour.**

**② Press SET.**

**5** **(“OFF” time setting)**  
**① Press or to select the hour.**

**② Press SET.**

**③ Press or to select the minutes.**

**④ Press SET.**

**5** **(“OFF” time setting)**  
**① Press or to select the hour.**

**② Press SET.**

**③ Press or to select the minutes.**

**④ Press SET.**

**6**   ① Press ◀ or ▶ to select the desired source.

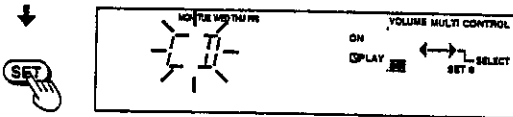

② Press SET.  
When you select tuner, select a desired preset channel using ◀ or ▶, and then press SET.

**7** **Prepare for the play.**  
When you play a CD: Load a disc.  
When you play a tape: Load a tape.

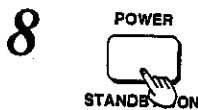

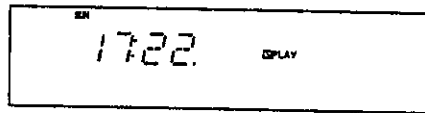

**Press POWER on the amplifier to switch the power to standby mode.**

Please confirm  PLAY appears on the display. The timer play will start at the preset time with volume increasing gradually up to the volume level you preset.



 PLAY



**To cancel the timer:**  
Press  PLAY to go out  PLAY on the display.

The play timer will not function, but the play timer setting will stay in the memory.

**If you make an error:**  
Follow the procedure from the first step.

**About the variation of the day setting:**

- One day from Sunday to Saturday: SUN...SAT
- Everyday from Sunday to Saturday: SUN-SAT
- Everyday from Monday to Saturday: MON-SAT
- Everyday from Monday to Friday: MON-FRI
- Saturday and Sunday only: SUN, SAT

CLOCK/TIMER



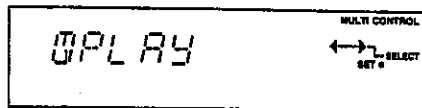

**To confirm the play timer:**  
Press CLOCK/TIMER to show  PLAY on the display.



The display will show the ON time, OFF time, the source you select, and the volume level in 2 seconds steps.

**To change the play timer setting:**  
Follow the procedure from the first step.

**Using the timer at the same time setting continuously:**

1. Press  PLAY to show  PLAY on the display.
2. Press POWER to switch the power to standby mode.

**To enjoy the desired source after the timer setting is completed:**

1. Start playing the desired source.  
Even if you change the volume level or music source, the timer play will start with the preset condition.
2. Press POWER to standby mode after enjoying the play.

**Notes**

- This system retains the ON/OFF time settings until you make a new setting. In case you make a new ON time setting which is later than the previous OFF time setting, the system automatically advances the day you set on the step 3. When you reset the OFF time, the day setting will return to the original setting.
- You cannot make the ON time and OFF time same setting.
- If the power is on, the timer will not function. The system must be in the standby mode.
- The play timer will function until you cancel the play timer mode.
- If you switch the power to standby mode while play timer is functioning, the OFF time setting will be cancelled.

**For your reference:**

When you insert cassettes in both deck 1 and deck 2, deck 1 has priority for timer play on tape.

Setting the record timer

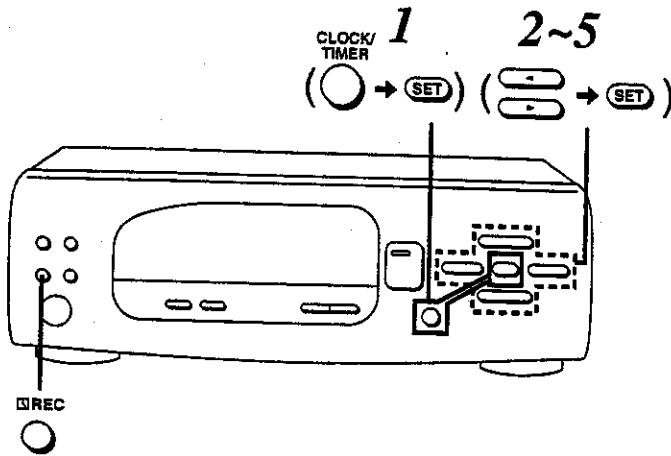
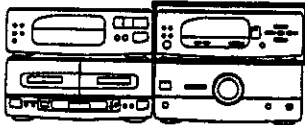

The following example shows how to set the record timer for recording FM preset channel 1 on Saturday from 18:30 to 20:00.

**1** **CLOCK/TIMER**

① Press **CLOCK/TIMER** twice to select **REC**.

Within 8 seconds:

② Press **SET**.

**2** **SET**

① Press **◀** or **▶** to select the day.

② Press **SET**.

**3** **SET**

① Press **◀** or **▶** to select the hour.

② Press **SET**.

**SET**

③ Press **◀** or **▶** to select the minutes.

④ Press **SET**.

**4** **SET**

① Press **◀** or **▶** to select the hour.

② Press **SET**.

③ Press **◀** or **▶** to select the minutes.

④ Press **SET**.

- 5**   ① Press ◀ or ▶ to select the desired preset channel.



- ② Press SET.

- 6** **Prepare for recording.**
1. Insert a cassette into deck 2.
  2. Select the Dolby NR.
  3. Select the reverse mode.
  4. Select the tape travel direction.

- 7**  **Press POWER on the amplifier to switch the power to standby mode.**



STANDBY ON

Please confirm  REC appears on the display.

 REC



#### To cancel the timer:

Press  REC to go out  REC on the display.

The record timer will not function, but the record timer setting will stay in the memory.

#### If you make an error:

Follow the procedure from the first step.

#### About the variation of the day setting:

One day from Sunday to Saturday: SUN...SAT  
Everyday from Sunday to Saturday: SUN-SAT

CLOCK/  
TIMER



**To confirm the record timer:**  
Press CLOCK/TIMER to show  REC on the display.

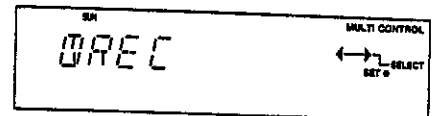



The display will show the ON time, OFF time, the broadcast band you select, in 2 seconds steps.

#### To change the record timer setting:

Press CLOCK/TIMER to return to step 1.



#### Using the timer at the same time setting continuously:

1. Press  REC to show  REC on the display.
2. Press POWER to switch the power to standby mode.

#### To enjoy the desired source after the timer setting is completed:

1. Start playing the desired source.  
When listening to a cassette tape, use the deck 1.  
Even if you change the music source, the timer recording will start with the preset condition.
2. After enjoying the source, prepare for recording, and then press POWER to standby mode.

#### Notes

- When the record timer is functioning, you cannot confirm the record timer.
- This system retains the ON/OFF time settings until you make a new setting. In case you make a new ON time setting which is later than the previous OFF time setting, the system automatically advances the day you set on the step 3. When you reset the OFF time, the day setting will return to the original setting.
- You cannot make the ON time and OFF time same setting.
- If the power is on, the timer will not function.
- Once the record timer operation finishes, it clears the record timer mode (except for "everyday from Sunday to Saturday" mode).
- When you want to record a same program over several weeks, (except when you select "everyday from Sunday to Saturday" mode), press  REC to show  REC on the display after the timer recording has finished.

#### For your reference:

While timer recording is taking place, the volume level will be automatically muted.

## To use the sleep timer

You can use this timer function to switch the power to the standby mode at a specified time (within a range of 1 minute to 120 minutes from the present time).

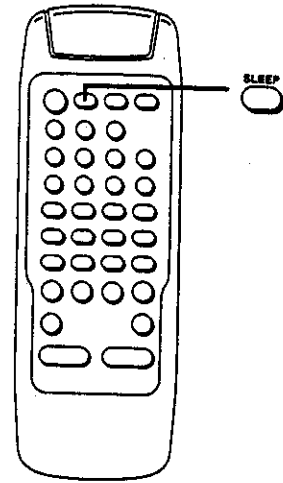
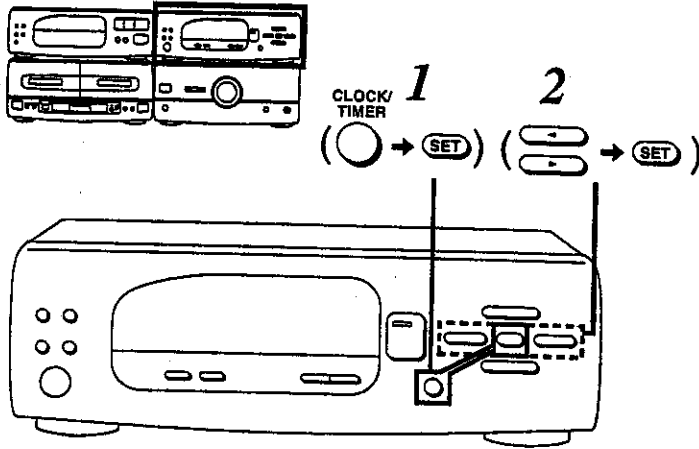

The following example shows how to set the system to standby mode after 30 minutes.

**1**

**CLOCK/TIMER**

While enjoying the desired source:  
 ① Press **CLOCK/TIMER** four times to select **SLEEP**.

Within 7 seconds:  
 ② Press **SET**.

**2**

① Press **←** or **→** to select the desired length of time.

② Press **SET**.  
 Please confirm **SLEEP** appears on the display.



**To cancel the sleep timer mode:**  
 Press **SLEEP** to go out the **SLEEP** on the display.  
 The time setting will remain in the unit's memory.



**To confirm the time remaining on the sleep timer:**  
 Press **CLOCK/TIMER** four times.

**To change the time setting while sleep timer is functioning:**  
 Follow procedure from the beginning.

**If you want to operate the system again on the same sleep time:**  
 Press **SLEEP** on the remote control to show "SLEEP" on the display.

## To use each timer mode in conjunction

*To go to sleep listening to a tape, and wake up the next morning listening to a compact disc, and record from a radio broadcast while going out*

1. Make a record timer setting. (See pages 44–45.)
2. Make a play timer setting for a compact disc. (See pages 42–43.)  
Be sure to set the timer play to be off before the timer recording will start.
3. Play back the tape in deck 1, and adjust the volume level.  
(Select "◀▶" of the reverse modes.)
4. Press CLOCK/TIMER to select SLEEP timer, and set the sleep time.

*To go to sleep listening to a compact disc, and then to make a timer recording from a radio broadcast*

1. Make a record timer setting. (See pages 44–45.)
2. Play a compact disc, and adjust the volume level.
3. Press CLOCK/TIMER to select SLEEP timer, and set the sleep time. (See page 46.)  
Be sure to set the sleep timer to off before the timer recording will begin.

*To make a timer recording from a radio broadcast while sleeping, and wake up the next morning listening to a cassette tape*

1. Make a record timer setting. (See pages 44–45.)
2. Make a play timer setting for deck 1, and switch the power to standby mode. (See pages 42–43.)  
Be sure to set the record timer to off before the play timer will begin.

Besides, you can combine sleep timer and play timer as well.

### Timer sequence of priority:

Sleep timer, record timer, play timer is the timer operation of priority in order. Be sure not to make each timer setting overlap.

Example 1:

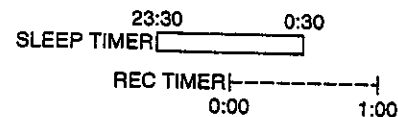

The sleep timer setting has priority, so the record timer will not function.

Example 2:

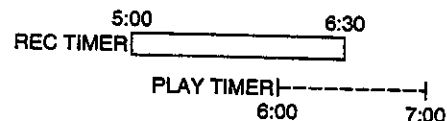

The record timer setting has priority, so the play timer will not function.

### For your reference:

When the OFF time of the record timer and the ON time of the play timer are the same, both timers will function.

When the OFF time of the play timer and the ON time of the record timer are the same, both timers will function.

# Enjoying the microphone mixing

This function mutes the vocal track but leaves the accompaniment allowing you to enjoy "KARAOKE" (singing with an accompaniment).

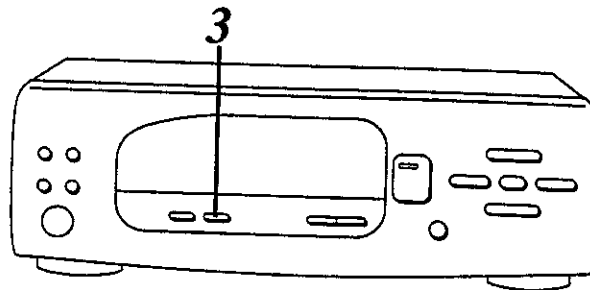
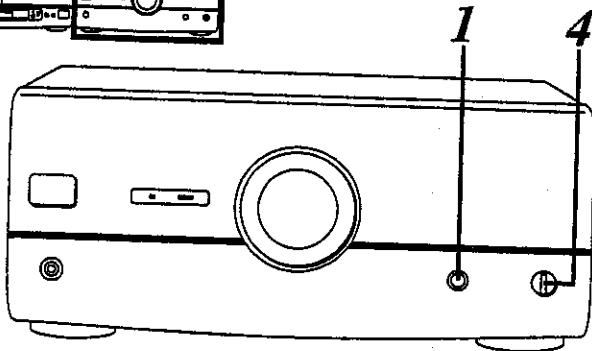
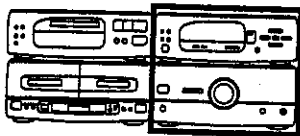

1



**Connect the microphone to MIC after reducing the volume level.**

Plug type: M6 monaural type

2



**Start playing a compact disc.**

3



**Press KARAOKE to ON.**

Each time you press KARAOKE, "VOICE MUTE", "L ONLY", "R ONLY" will be displayed in order.

When you use a sound multiplex source, select "L ONLY" or "R ONLY".

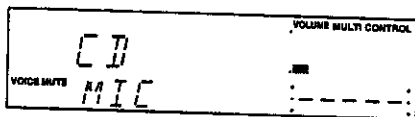

4



**Start microphone mixing, and adjust the microphone level.**



KARAOKE



**To cancel the "KARAOKE" mode:**

Press KARAOKE to go out the indicator.

When VOICE MUTE lights:

Press 3 times.

When L ONLY lights:

Press twice.

When R ONLY lights:

Press once.

**To record of your "KARAOKE" performance:**

Start recording on deck 2, then start "KARAOKE". To playback the tape recorded in "KARAOKE" mode, press KARAOKE to go out the "KARAOKE" mode indicator (VOICE MUTE, L ONLY, R ONLY).

**You cannot record in "KARAOKE" mode using:**

A tone quality effect (equalization curve, simulated listening environment, and V.BASS effect)

A cassette tape originally made for KARAOKE use

**You cannot use "KARAOKE" function with:**

A tone quality effect (equalization curve, simulated listening environment effect)

A monaural source

## Notes

- "KARAOKE" mode cannot be activated when you select "TUNER".
- During CD edit recording, you cannot alter the KARAOKE mode.
- This function may not be effective according to the type of music.
- If you hear strange noises (squealing or howling) during mixing, move the microphone farther away from the speakers or turn down the volume and microphone volume on the amplifier.
- When you are not using the microphone, disconnect it from the MIC jack, and turn down the microphone volume level to MIN.
- Do not press KARAOKE when recording on a DCC or DAT.



# Using an external unit

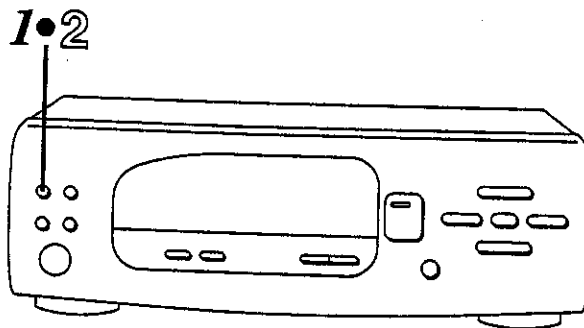
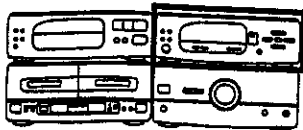

## Listening to an external source

You can connect DCC (or DAT) or analog turntable to this system.

The following example shows when you select DCC.



Press EXT to select the external source.

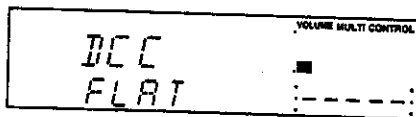

Each time you press EXT, "DCC" and "PHONO" will be alternately displayed.

2

Operate the unit which is connected to the system.

See the instruction manual of the unit concerned for operating instructions.

4

Start playing the source to be recorded.

See the instruction manual of the unit concerned for operating instructions.



To stop recording:

Press on the cassette deck.



To briefly interrupt recording:

Press REC PAUSE on the cassette deck.

The cassette deck will go into the recording standby state.



To resume recording:

Press one of the playback buttons (< or >) corresponding to the direction in which recording is taking place.

## Recording from an external source

The following example shows when you record from an analog player.

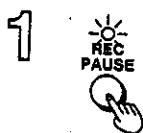

Press REC PAUSE on the cassette deck to put the cassette deck into the recording standby mode.

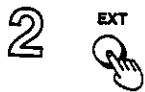

Press EXT to select an external source from which you want to record.



Press one of the playback buttons (< or >) on the cassette deck to start recording.

### To record on a DCC (or DAT) tape:

Start recording on a DCC (or DAT), and then start playing the source to be recorded.

You cannot record the sound with the equalization curve, simulated listening environment, and V.BASS effect on a DCC (or DAT) tape.

#### Note

Do not press KARAOKE when recording on a DCC or DAT.

# Remote control operations

## —quick reference—

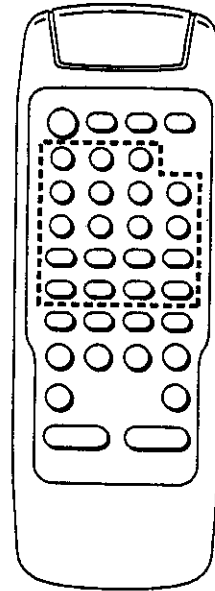
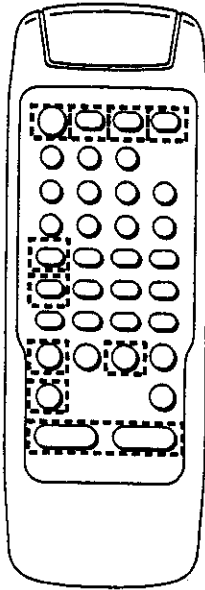

### Common operation

Switching the system on and power standby mode	POWER 
Starting play directly from the power standby condition	TUNERBAND
Selecting the input source	TUNERBAND  CD
Adjusting the volume	VOLUME -  +
Muting the volume temporarily	MUTING

### Tuner/timer operation

Listening to the radio broadcasts	TUNERBAND  →
Switching between FM stereo mode and monaural	FM MODE
Operating/releasing the sleep timer	SLEEP

### CD section

Starting play	
Temporarily stopping play	
Stopping play	
Skipping tracks	
Starting play from a particular track	CD  →
Playing the particular track you programmed	CD  → PROGRAM  →  →
Cancelling the particular track you programmed	CD  → CANCEL  →  →

## Remote control operations —quick reference—

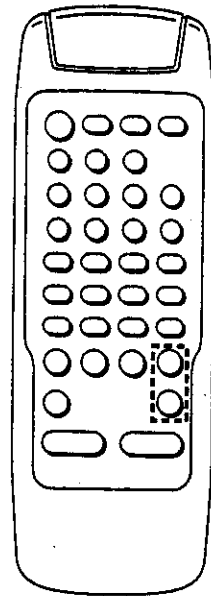
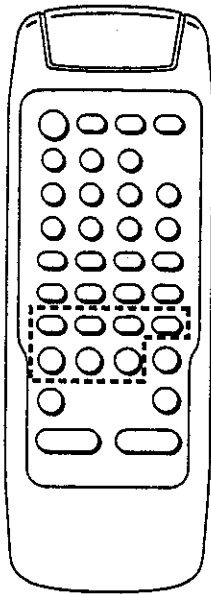

### *Tape section*

Switching between deck 1 and deck 2	DECK 1/2 
Starting playback	
Finding the beginning of a track	During playback 
Fast forwarding or rewinding the tape	In stop mode 
Stopping playback	
Recording	→

### *Tone control section*

Switching between equalization curve and simulated listening environment	EQ SPACE MODE 
Switching equalization curve or simulated listening environment on or off	OVERLAY 
Switching between PRESET and USER mode	Press and hold EQ SPACE MODE 

# Concerning compact discs

Only compact discs having this mark can be used with this unit.



## To remove a disc from its case

Press the center holder and lift the disc holding by the edges.

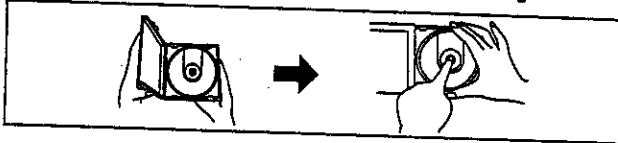

## To hold the disc

Hold the disc by the edges so the surface is not soiled with fingerprints. Fingerprints, dirt and scratches can cause skipping and distortion.

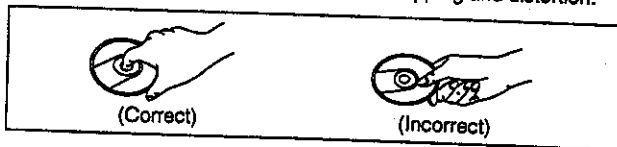

## To store a disc in its case

Insert the disc with label facing upwards and press downward at the center.

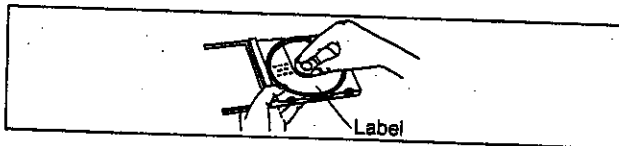

## If the surface is soiled

Wipe gently with a soft, damp (water only) cloth.

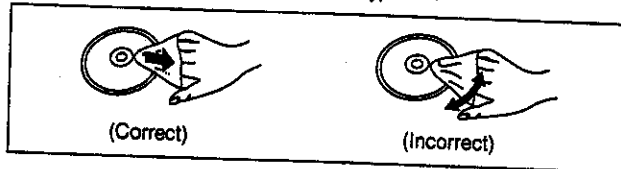

## If the disc is brought from a cold to a warm environment, moisture may form on the disc

Wipe this moisture off with a soft, dry, lint-free cloth before using the disc.

## Improper disc storage:

You can damage discs if you store them in the following places:

- Areas exposed to direct sunlight
- Humid or dusty areas
- Areas directly exposed to a heat outlet or heating appliance

## Handling precautions:

- Do not write on the label side with a ball-point pen or other writing utensils.
- Do not use record cleaning sprays, benzene, thinner, static electricity prevention liquids or any other solvent.
- Do not soil with fingerprints.

# Maintenance

## Maintenance of external surfaces

To clean this unit, use a soft, dry cloth.

If the surfaces are extremely dirty, use a soft cloth dipped in a soap-and-water solution or a weak detergent solution.

Wring the cloth well before wiping the unit.

Wipe once again with a soft, dry cloth.

Never use alcohol, paint thinner, benzene, or chemically treated cloths to clean this unit. Such chemicals may damage the finish of your system.

## Tape head care

To assure sound quality for recording and playback, be sure to clean the tape heads after approximately every 10 hours of use.

1. Press **POWER** on the power amplifier to **ON**.
2. Press **▲ OPEN**.
3. Press **POWER** on the amplifier and **CLOSE** at the same time.  
The system will go into power standby mode leaving the cassette holder open.
4. Clean the tape heads, pinch rollers and the capstan shafts with a cotton swab (or a soft, lint-free cloth) slightly moistened with Isopropyl alcohol.

Do not use any solution other than alcohol for head cleaning.

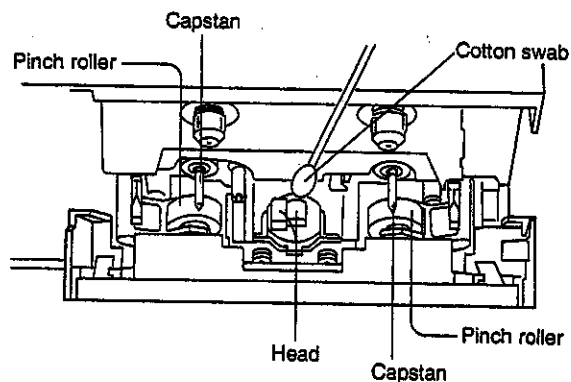

# Concerning cassette tapes

## Selection of cassette tapes

Cassette tape exceeding 90 minutes:

These tapes are handy for their long playback and recording time but be careful about repeatedly stopping, starting, rewinding and fast forwarding these tapes in short intervals as they are thin, tend to stretch and may become entangled in the machine.

Do not use the Fe-Cr tapes (TYPE III) in this system:

If you use this tape, it is impossible to obtain the required flat frequency response.

## If the tape loosens, take up the slack

Tape slack may cause the tape to break.

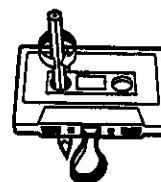

## To prevent erasure of recorded sounds

Remove the erase-prevention tabs with a screwdriver or a similar object.

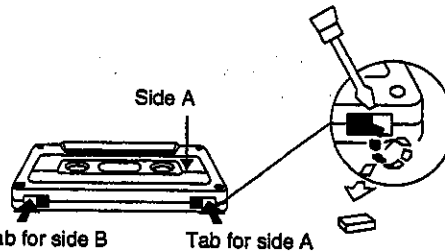

To re-record on a protected cassette, cover the slot with adhesive tape.

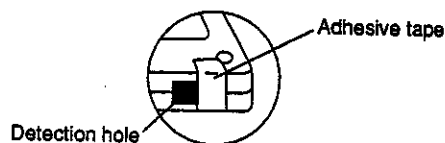

Do not cover the detection holes on chrome and metal tapes.

## Improper tape storage:

You can damage tapes if you store them in the following places:

- In high temperature [35°C (95°F) or higher] or high humidity (80% or higher) areas
- In a strong magnetic field (near a speaker, on top of a TV, etc.)  
This can erase a recording.
- Areas exposed to direct sunlight

# Troubleshooting guide

Before requesting service for this unit, check the chart below for a possible cause of the problem you are experiencing. Some simple checks or a minor adjustment on your part may eliminate the problem and restore proper operation. If you are in doubt about some of the check points, or if the remedies indicated in the chart do not solve the problem, refer to the directory of Authorized Service Centers (enclosed with this unit) to locate a convenient service center, or consult your dealer for instructions.

Problem	Probable cause(s)	Suggested remedy
<b>Problems common to all systems</b>		
There is no sound when the power is ON.	Volume is set too low.	Adjust the volume level with the volume control on the amplifier.
The location of the various musical instruments is not well defined.	The (+) and (-) connections to one of the speakers are reversed.	Connect the speaker cord correctly.
The left and right sounds are reversed.	The left and right connections to the speaker are reversed.	Connect the speaker cord correctly.
	The left and right connections to the each unit are reversed.	Connect the each unit's cord correctly.
Only one speaker is emitting sound.	One of the wires of the speaker cord is disconnected.	Connect the speaker cord correctly.
There is no sound when a source is being played.	The (+) and (-) wire of the speaker cords are shorted.	Switch the system to the standby mode, and reconnect the speaker cords so that they are not shorted. Then switch on the power.
"U-70" display appears on the compact disc player or tuner/sound processor display.	Flat cables are not connected steadily.	Connect the flat cables steadily.

<b>While listening to FM broadcasts</b>		
There is a "rushing noise" during a stereo broadcast which is not audible during a monaural broadcast.	The transmitting station is a long distance away.	<ul style="list-style-type: none"> <li>• If you are using an indoor antenna, change to an outdoor antenna.</li> <li>• If you are using a high-grade outdoor antenna, try changing the installation location, height and orientation.</li> </ul>
You hear excessive noise during a stereo broadcast, and occasionally the sound disappears.	The installation location and orientation of the antenna are unsuitable.	
The stereo indicator flickers and does not light completely.	The transmitting station is a long distance away.	
The sound during a stereo broadcast is highly distorted.	The power of the TV set or VCR is ON.	Try switching off the TV set or VCR.
	There is a building or mountain nearby. [Distortion is caused by interference between the signal from the transmitting station (direct wave) and the signal reflected from the building or mountain (reflected wave).]	Use a high-grade outdoor antenna, and install it in a good location, height and orientation for reception.

<b>While listening to LW/MW broadcasts</b>		
You hear an unusual beat sound.	You are using the system at the same time you are playing a TV set.	Switch off the TV set, or use the system farther away from it.
You hear a low-frequency hum.	The antenna wire is near the power cord.	Separate the antenna wire from the power cord.

Problem	Probable cause(s)	Suggested remedy
---------	-------------------	------------------

**When there is a television set nearby**

The picture on the TV disappears or stripes appear on the screen.	The location and orientation of the antenna are incorrect.	If you are using an indoor antenna, change to an outdoor antenna.
	The wiring at the back of the system is unsuitable.	Separate the antenna wire of the TV set from the system.

**While listening to tapes**

Sound is low, intermittent, or poor quality, noisy, scratchy, or unsteady.	Heads are dirty.	Clean the heads.
	The Dolby noise reduction is set in the wrong position.	Set it to match the Dolby NR recording mode.
The deck does not enter the recording mode.	The erase-prevention tabs are removed from the cassette.	Attach tape to cover the space left by removal of the erase-prevention tabs.

**While listening to compact discs**

The display will not show the correct indication. Disc play does not start when you press the play button.	The disc is not positioned correctly in the disc tray.	Load the disc on the tray correctly.
	The disc is loaded upside down.	Reload the disc.
	The disc is dirty.	Wipe the disc with a soft cloth.
	The disc is scratched.	Replace the disc with a new one.
	The disc is badly warped.	
	The disc is nonstandard one.	Replace the disc with a different one.
	There is condensation inside the disc player.	Switch the power ON, and then wait for 60 minutes before using the disc player.

**While using the remote control**

The system cannot be operated with the remote control.	The batteries are installed in the reverse polarity.	Re-insert the batteries in the correct polarity.
	The batteries are worn.	Replace the batteries with new batteries.

# Technical specifications

## TUNER/SOUND PROCESSOR

### ■ Pre-amplifier section

#### Input sensitivity/Impedance

PHONO (For United Kingdom)	2.5 mV/47 k $\Omega$
AUX (For others)	250 mV/15 k $\Omega$
DCC	250 mV/15 k $\Omega$

#### Output level

DCC RECOUT	150 mV/1.5 k $\Omega$
------------	-----------------------

#### Frequency response

PHONO (For United Kingdom)	30 Hz–15 kHz/+1.5 to –2.0 dB
AUX (For others)	30 Hz–20 kHz
DCC	30 Hz–20 kHz

### ■ EQ, SFP section

#### Center frequency

80, 250, 1 k, 4 k, 12.5 k (Hz)

#### Fixed mode

SPACE	3 modes (DISCO, LIVE, HALL)
GEQ	5 modes (HEAVY, CLEAR, SOFT, CAR, HP ST)

### ■ FM tuner section

#### Frequency range

87.50–108.00 MHz (0.05 MHz steps)

Sensitivity	1.8 $\mu$ V (IHF, usable)
S/N 26 dB	1.5 $\mu$ V (75 $\Omega$ )
S/N	MONO 70 dB (75 dB, IHF)
Stereo separation at 1 kHz	35 dB
Antenna terminal(s)	75 $\Omega$ (unbalance)

### ■ AM tuner section

#### Frequency range

MW	522–1611 kHz (9 kHz steps)
	530–1620 Hz (10 kHz steps)
LW	144–288 kHz (9 kHz steps)

#### Sensitivity (S/N 20 dB)

MW	500 $\mu$ V/m
LW	50 $\mu$ V

### ■ Timer section

#### Clock

Quartz-lock type

#### Function

24-hour programmable; play timer (1 time), Rec timer (1 time), Sleep (120 min., 1 min. intervals)

#### Setting

1 minute–23 hours 59 minutes (1 min. intervals)

### ■ General

#### Dimensions (W×H×D)

270×89×274 mm

#### Weight

1.75 kg

## AMPLIFIER

#### Power output

DIN 1 kHz, THD 1%, both channel driven	
(For United Kingdom)	2×35 W (6 $\Omega$ )
(For others)	2×50 W (6 $\Omega$ )

#### Total harmonic distortion

Rated power at 1 kHz	1% (6 $\Omega$ )
Half power at 1 kHz	0.09% (6 $\Omega$ )

#### Load impedance

MAIN	6–8 $\Omega$
SURROUND	8 $\Omega$
S/N (rated power)	84 dB

#### Frequency response

40 Hz–30 kHz (–3 dB)

### ■ General

#### Power consumption

(For United Kingdom)	128 W
(For others)	163 W

#### Power supply

230 V–240 V, AC 50/60 Hz

#### Dimensions (W×H×D)

270×118.5×336 mm

#### Weight

(For United Kingdom)	4.2 kg
(For others)	4.4 kg

## CD PLAYER

### ■ Audio

DA converter 1 bit 2 DAC MASH

### ■ Pickup

Wavelength 780 nm

#### Laser power

No hazardous radiation is emitted (with safety protection).

### ■ General

#### Dimensions (W×H×D)

270×89.0×262 mm

#### Weight

1.9 kg

## CASSETTE DECK

Deck system Stereo cassette deck

Track system 4-track, 2-channel

Recording system AC bias

Bias frequency 80 kHz

Erasing system AC erase

#### Heads

Deck 1 (Playback head) Permalloy head

Deck 2 (Recording/Playback) Permalloy head

(Erasure) Double gap ferrite head

Motors Deck 1, 2 (Capstan/reel table drive) DC servo motor

(Reel table drive) DC motor

Tape speed 4.8 cm/sec.

Wow and flutter 0.1% (WRMS)

Fast forward and rewind times Approx. 45 seconds with C-60 cassette tape

#### Frequency response

(Dolby NR off, CCRT on)

NORMAL 20 Hz–17 kHz  
30 Hz–15 kHz

CrO<sub>2</sub> 20 Hz–18 kHz  
30 Hz–17 kHz

METAL 20 Hz–20 kHz  
30 Hz–19 kHz

#### S/N (CrO<sub>2</sub>)

NR off 56 dB (A weighted)

Dolby B NR on 66 dB (CCIR)

#### Input sensitivity and impedance

LINE IN 126 mV/17.6 k $\Omega$

#### Output voltage and impedance

LINE OUT 400 mV/220 $\Omega$

### ■ General

#### Dimensions (W×H×D)

270×118.5×263 mm

#### Weight

2.85 kg

## SPEAKER SYSTEM

Type 3-way, 3 speakers, bass-reflex

Speaker(s) Woofer 14 cm cone type

Midrange 6 cm cone type

Tweeter piezo type

#### Impedance

6 $\Omega$

#### Input power

(For United Kingdom)

80 W (music), 40 W (DIN)

(For others) 100 W (music), 50 W (DIN)

#### Output sound pressure level

(For United Kingdom) 86 dB/W (1.0 m)

(For others) 85 dB/W (1.0 m)

#### Cross over frequency

(For United Kingdom) 3.5 kHz, 10 kHz

(For others) 2 kHz, 10 kHz

#### Frequency range

(For United Kingdom)

45 Hz–22 kHz (–16 dB)

50 Hz–20 kHz (–10 dB)

(For others) 40 Hz–22 kHz (–16 dB)

45 Hz–20 kHz (–10 dB)

### ■ General

#### Dimensions (W×H×D)

(For United Kingdom)

230×414×270 mm

(For others) 230×414×265 mm

#### Weight

(For United Kingdom) 4.6 kg

(For others) 4.4 kg

#### Notes:

- Specifications are subject to change without notice. Weight and dimensions are approximate.
- Total harmonic distortion is measured by the digital spectrum analyzer.

MASH is a trademark of NTT.

#### For UK only

This apparatus was produced to BS 800.

Matsushita Electric Industrial Co., Ltd.  
Central P.O. Box 288, Osaka 530-91, Japan

Printed in Japan

RQT2107-1B  
F0793P1073



## Free Manuals Download Website

<http://myh66.com>

<http://usermanuals.us>

<http://www.somanuals.com>

<http://www.4manuals.cc>

<http://www.manual-lib.com>

<http://www.404manual.com>

<http://www.luxmanual.com>

<http://aubethermostatmanual.com>

Golf course search by state

<http://golfingnear.com>

Email search by domain

<http://emailbydomain.com>

Auto manuals search

<http://auto.somanuals.com>

TV manuals search

<http://tv.somanuals.com>